



HAL
open science

Physics of helicon waves and negative ions in the Resonant Antenna Ion Device (RAID)

Ivo Furno, Riccardo Agnello, Philippe Guittienne, A.A. Howling, Rémy
Jacquier, Gennady Plyushchev, Basile Pouradier Duteil, Christine Stollberg,
M Barbisan, M. Fadone, et al.

► **To cite this version:**

Ivo Furno, Riccardo Agnello, Philippe Guittienne, A.A. Howling, Rémy Jacquier, et al.. Physics of helicon waves and negative ions in the Resonant Antenna Ion Device (RAID). 29th International Toki Conference on Plasma and Fusion Research (ITC 29), Oct 2020, Toki, Japan. hal-03434682v2

HAL Id: hal-03434682

<https://hal.science/hal-03434682v2>

Submitted on 18 Nov 2021

HAL is a multi-disciplinary open access archive for the deposit and dissemination of scientific research documents, whether they are published or not. The documents may come from teaching and research institutions in France or abroad, or from public or private research centers.

L'archive ouverte pluridisciplinaire **HAL**, est destinée au dépôt et à la diffusion de documents scientifiques de niveau recherche, publiés ou non, émanant des établissements d'enseignement et de recherche français ou étrangers, des laboratoires publics ou privés.



Physics of helicon waves and negative ions in the Resonant Antenna Ion Device (RAID)

Ivo Furno¹, R. Agnello¹, Ph. Guittienne¹, A.A. Howling¹, R. Jacquier¹, G. Plyushchev¹, B. Pouradier Duteil¹, C. Stollberg¹, M. Barbisan², M. Fadone², R. Pasqualotto², S. Béchu³, A. Simonin⁴, F. Taccogna⁵, G. Fubiani⁶

[1] Swiss Plasma Center, Ecole Polytechnique Fédérale de Lausanne, Switzerland, [2] Consorzio RFX, Corso Stati Uniti 4, I-35127 Padova, Italy, [3] Université Grenoble-Alpes, CNRS, Grenoble INP, LPSC-INP23, 38000 Grenoble, France, [4] CEA, IRFM, F-13108 St-Paul-lez-Durance, France, [5] Istituto di Metodologie Inorganiche e dei Plasmi (IMIP), Consiglio Nazionale delle Ricerche, via Amendola 122/D, 70124 Bari, Italy, [6] CNRS, LAPLACE laboratory, University of Toulouse III

ITC 29, OCTOBER 27-30, 2020, | Ceratopia Toki, Toki City, Gifu, Japan



This work has been carried out within the framework of the EUROfusion Consortium and has received funding from the Euratom research and training programme 2014-2018 and 2019-2020 under grant agreement No 633053. The views and opinions expressed herein do not necessarily reflect those of the European Commission.

Species	D ⁻
Beam Energy [keV]	800
Filling pressure [Pa]	0.3
Neutralization efficiency	>0.65
Extracted e-/D- fraction	<1

Photo-neutralization concept

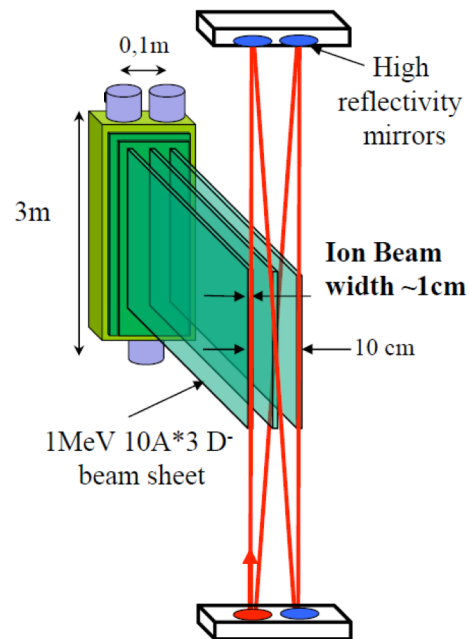

A. Simonin et al., New J. Physics 18, 125005 (2016)

Species	D ⁻
Beam Energy [keV]	800
Filling pressure [Pa]	0.3
Neutralization efficiency	>0.65
Extracted e ⁻ /D ⁻ fraction	<1

Photo-neutralization concept

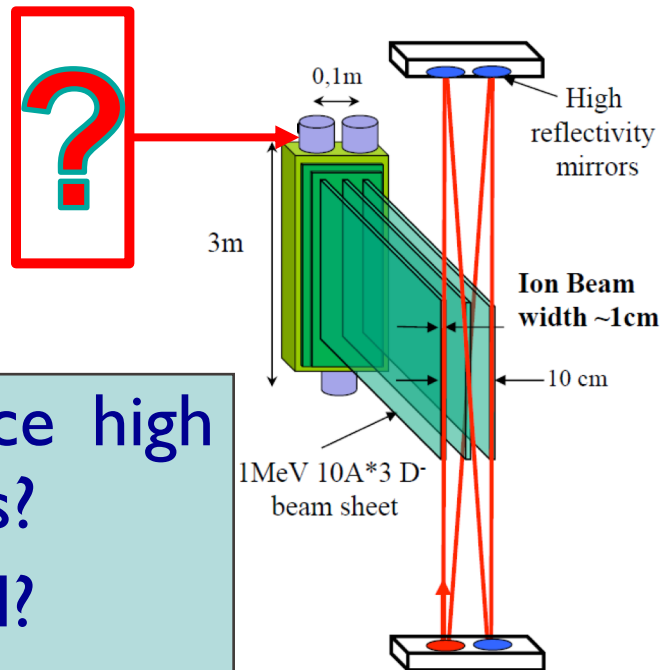

1. Can helicon waves produce high power, steady-state plasmas?
2. Are negative ions produced?
3. Can negative ions be extracted?

Species	D ⁻
Beam Energy [keV]	800
Filling pressure [Pa]	0.3
Neutralization efficiency	>0.65
Extracted e ⁻ /D ⁻ fraction	<1

Photoneutralization concept

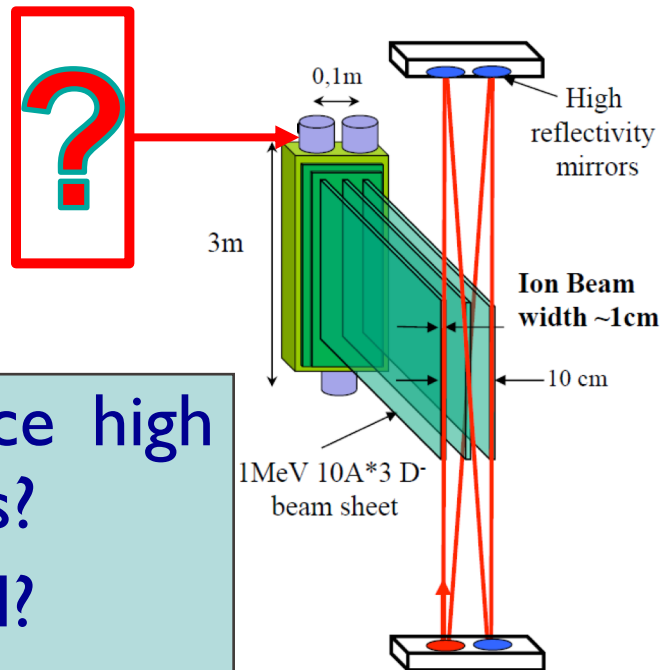

1. Can helicon waves produce high power, steady-state plasmas?
2. Are negative ions produced?
3. Can negative ions be extracted?

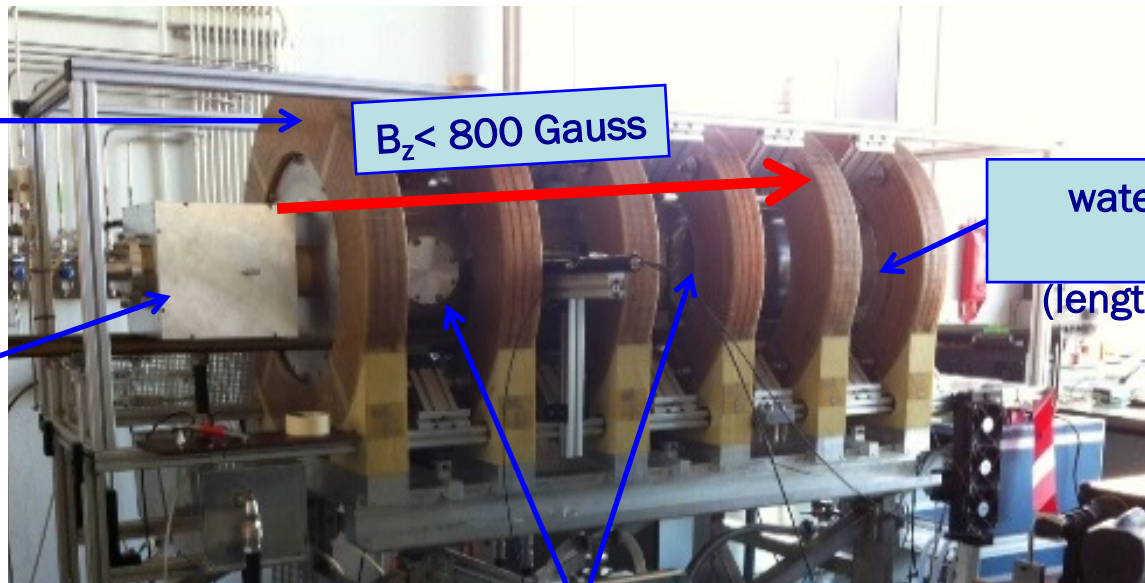

6 independent
B field coils

$B_z < 800$ Gauss

water-cooled vacuum
vessel
(length 2m, diam. 0.4m)

Steady state
10kW
13.56MHz
birdcage
antenna

Full diagnostic access

I. Furno et al., EPJ Web of Conferences 157, 03014 (2017)

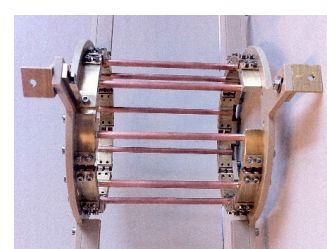

9 water-cooled copper legs

D=13 cm
L = 15 cm

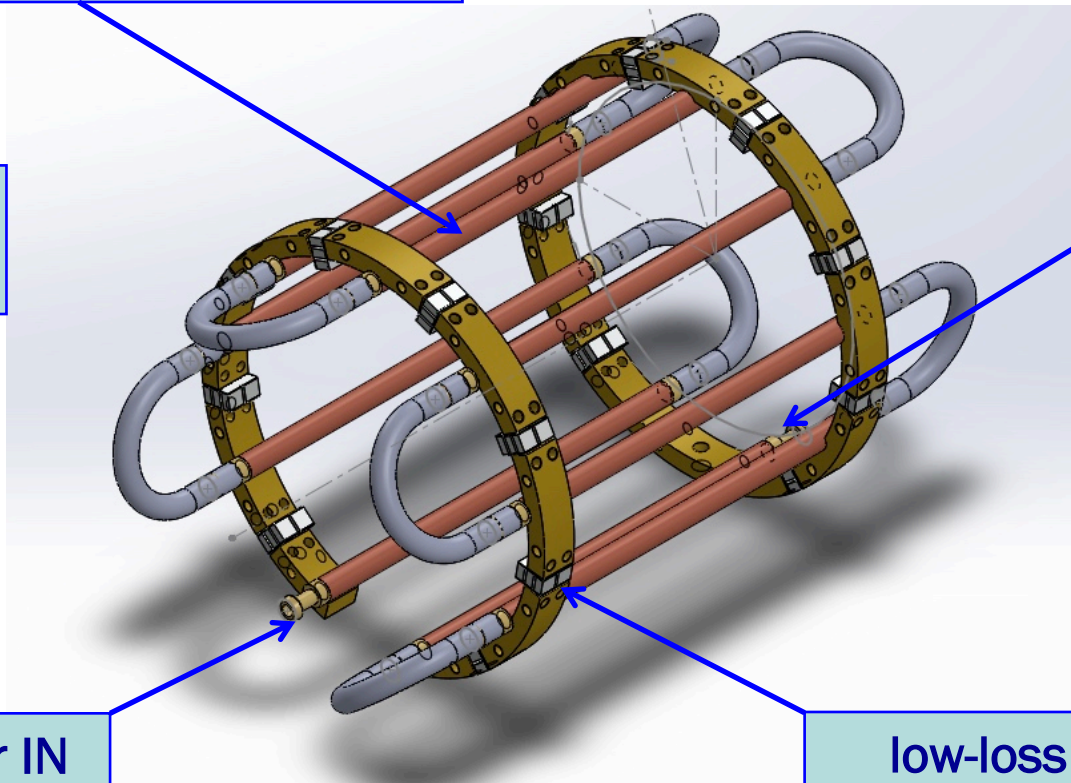

water OUT

water IN

low-loss capacitors

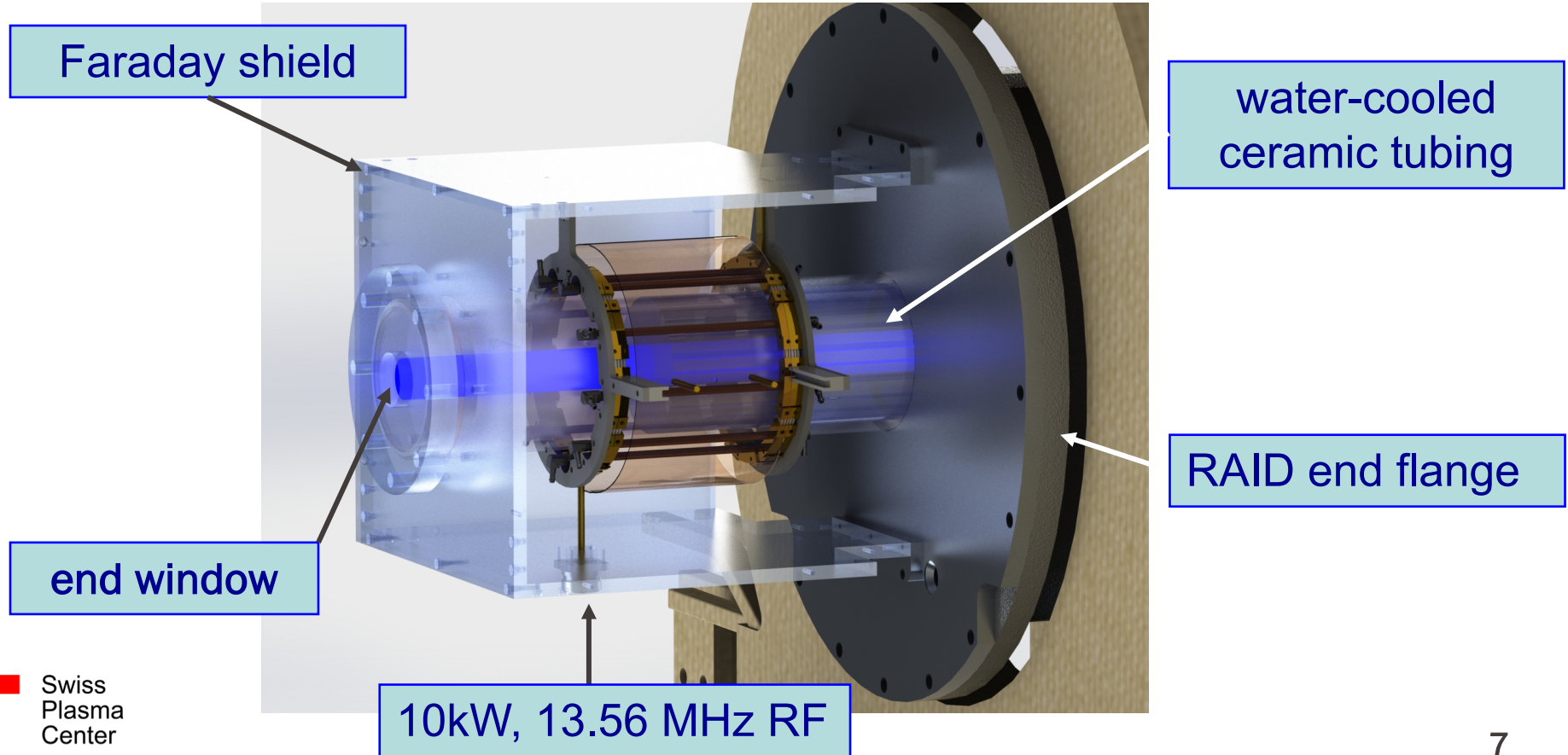

A 3 kW, 0.3 Pa, H₂ plasma

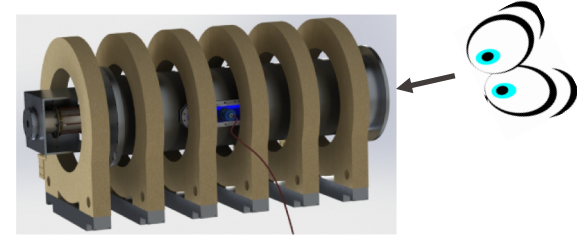

resonant antenna

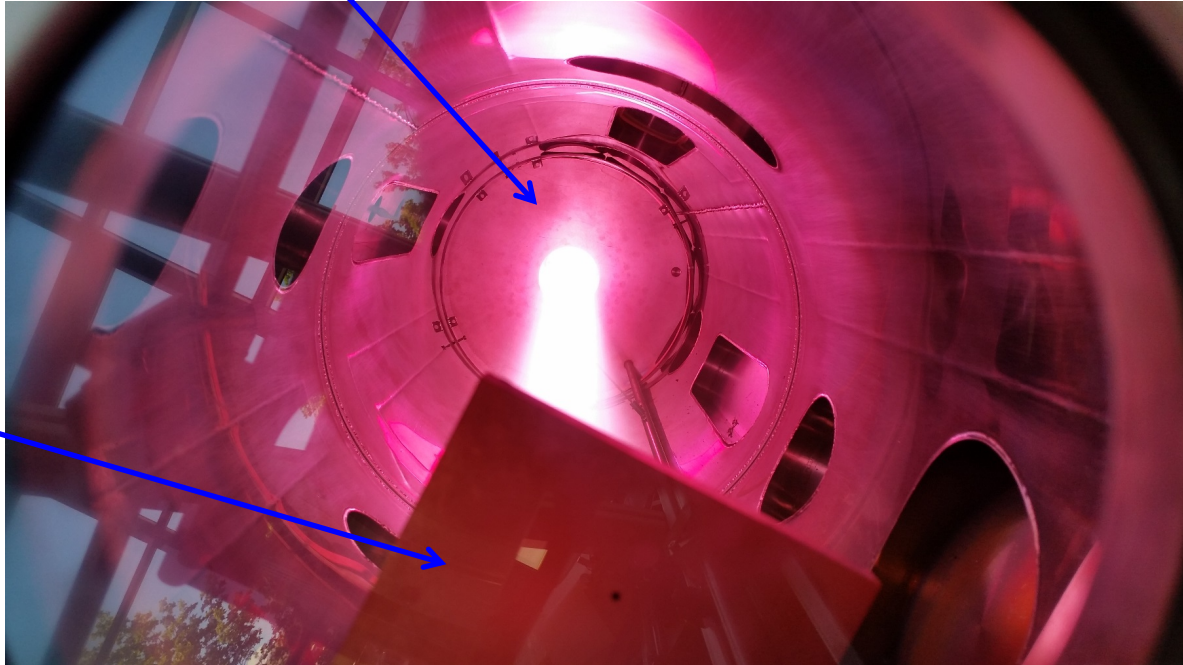

water-cooled end plate

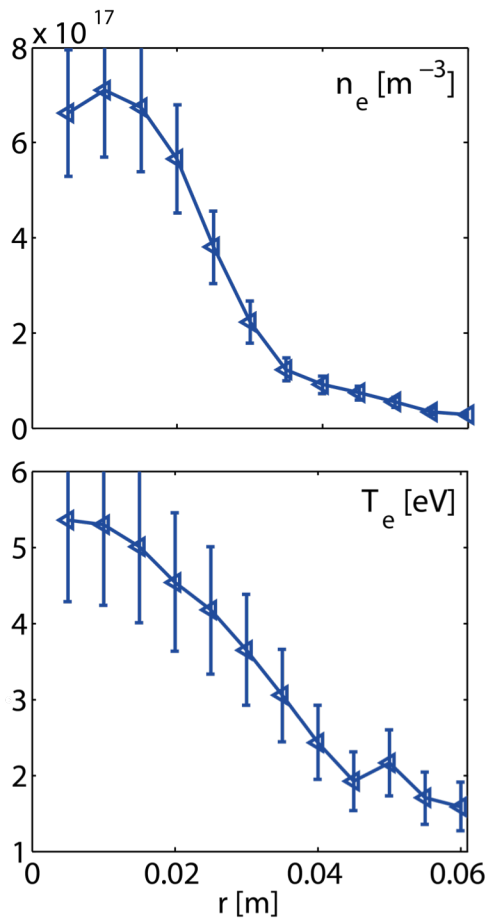

Gas	$\text{H}_2, \text{D}_2, \text{Ar}, \text{He}, \dots$
B field [Gauss]	< 800
Filling pressure [Pa]	> 0.1
T_{e0} [eV]	5-6
n_{e0} [m^{-3}]	$10^{17} - 10^{18}$ [H_2] 2×10^{19} [Ar]

- Helicon waves in RAID
- Physics of negative ions in H₂/D₂ plasmas
 - ✓ Experimental measurements: Optical emission spectroscopy (OES), Laser-based diagnostics
 - ✓ A fluid model for H₂ plasmas
- Take home message: resonant antennas produce helicon plasmas characterized by a negative ion population mostly generated by dissociative attachment on vibrationally excited H₂ molecules

Helicon waves: Right (R)-handed polarized Whistler EM waves ($\omega_{ci} \ll \omega \ll \omega_{ce}$)

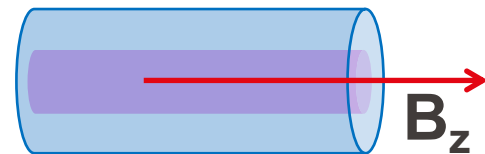

$$e^{i\left(m\theta + \frac{2\pi}{\lambda_z}z\right)}$$

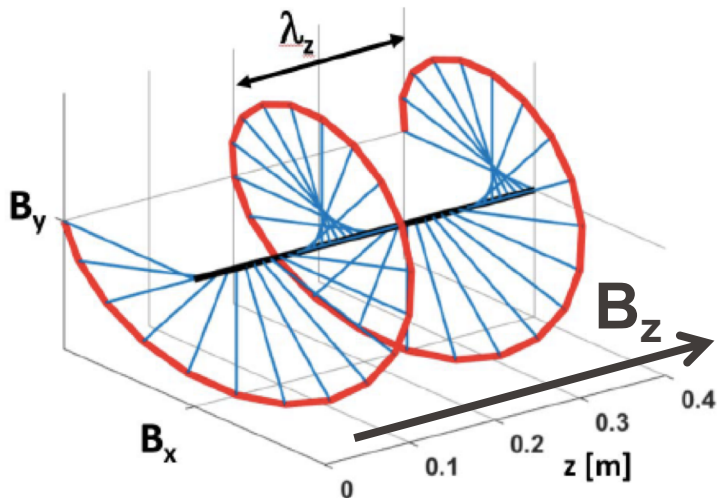

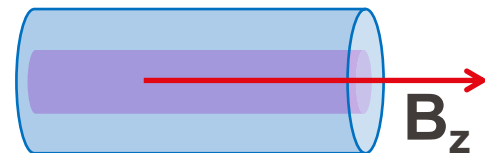

$$e^{i\left(m\theta + \frac{2\pi}{\lambda_z} z\right)}$$

Helicon waves: Right (R)-handed polarized Whistler EM waves ($\omega_{ci} \ll \omega \ll \omega_{ce}$)

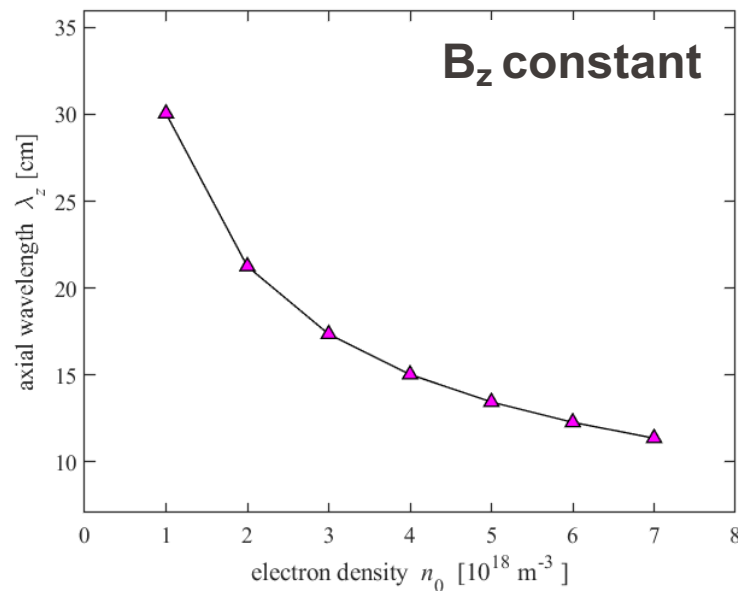
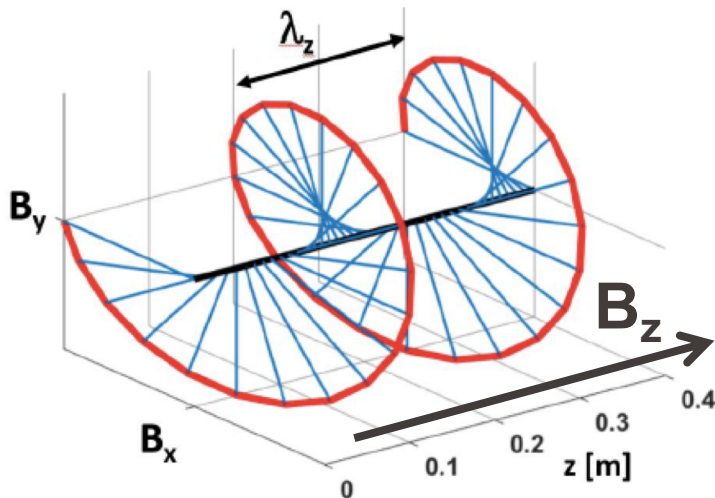

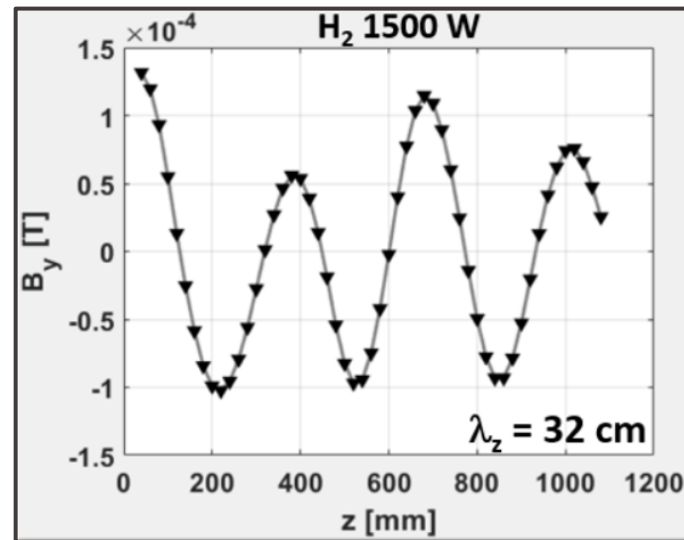
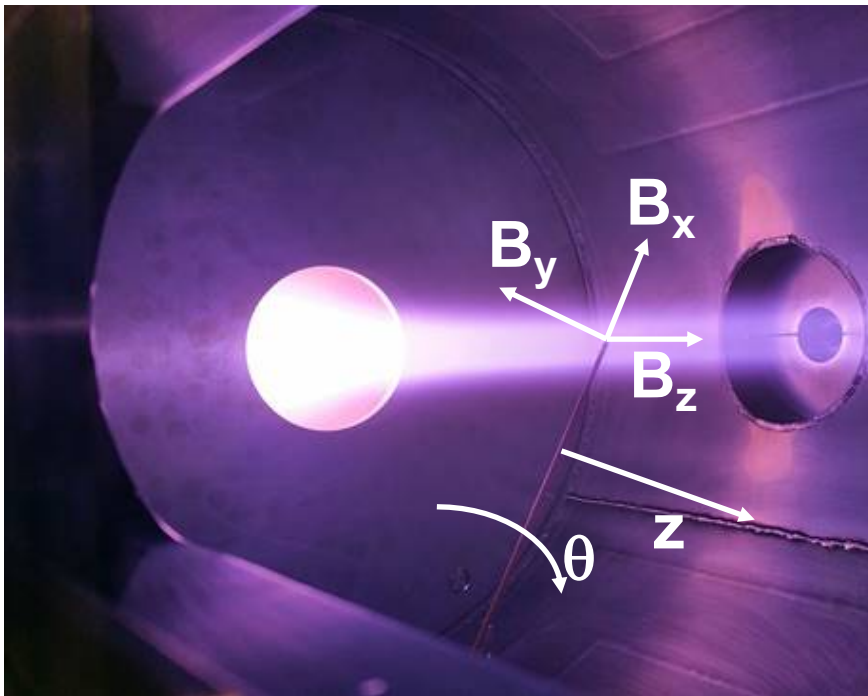

Ph. Guittienne et al., *Unbounded helicon wave plasma generated by a resonant birdcage antenna*, in preparation

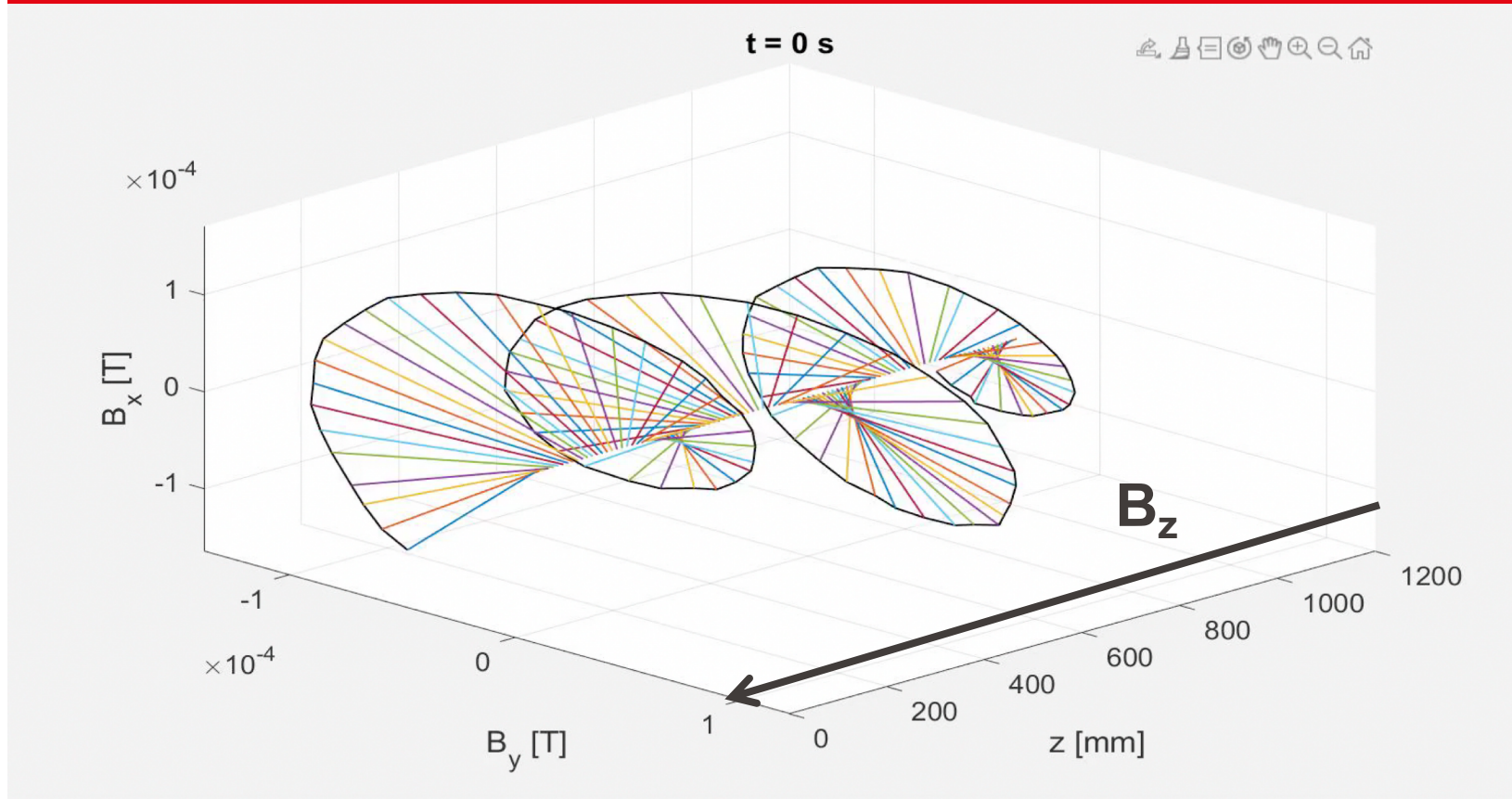

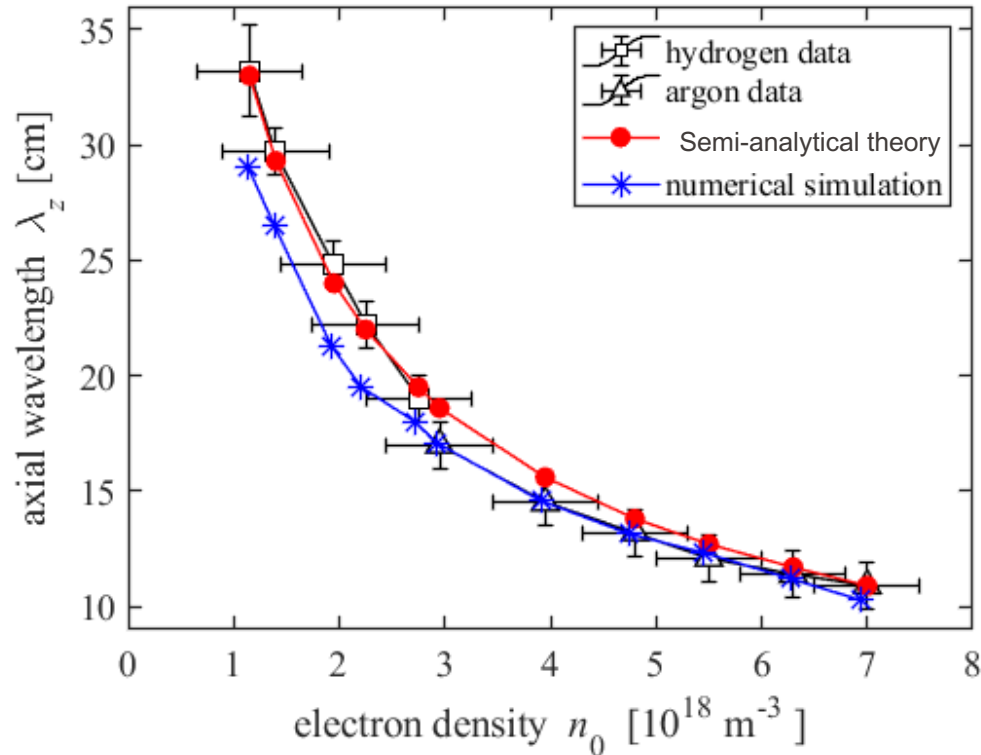

- Helicon waves in RAID
- Physics of negative ions in H₂/D₂ plasmas
 - ✓ Experimental measurements: Optical emission spectroscopy (OES), Laser-based diagnostics
 - ✓ A fluid model for H₂ plasmas
- Take home message: resonant antennas produce helicon plasmas characterized by a substantial negative ion population mostly generated by dissociative attachment on vibrationally excited molecules

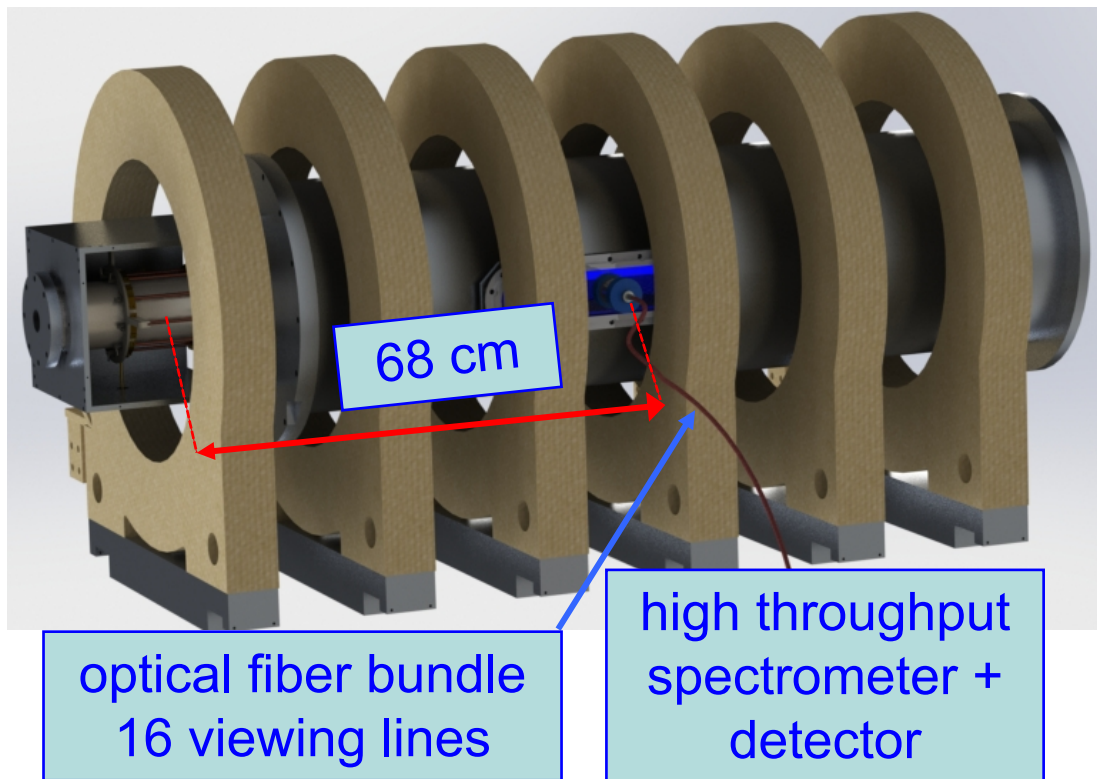

Optical emission
spectroscopy of
Balmer lines + Fulcher



Optical tomography



Collisional radiative
code YAKORA



H_2 , H , H^+ , H^- , ...

C. Marini et al., Nucl. Fusion 57, 036024 (2017)

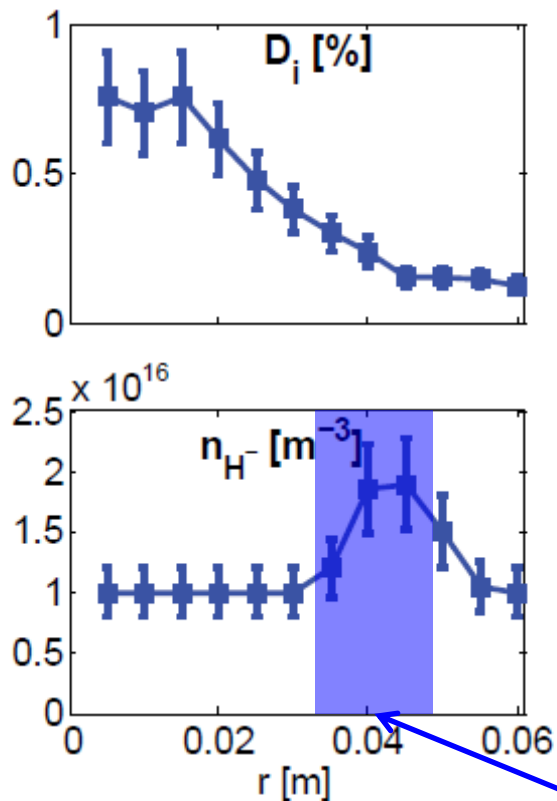
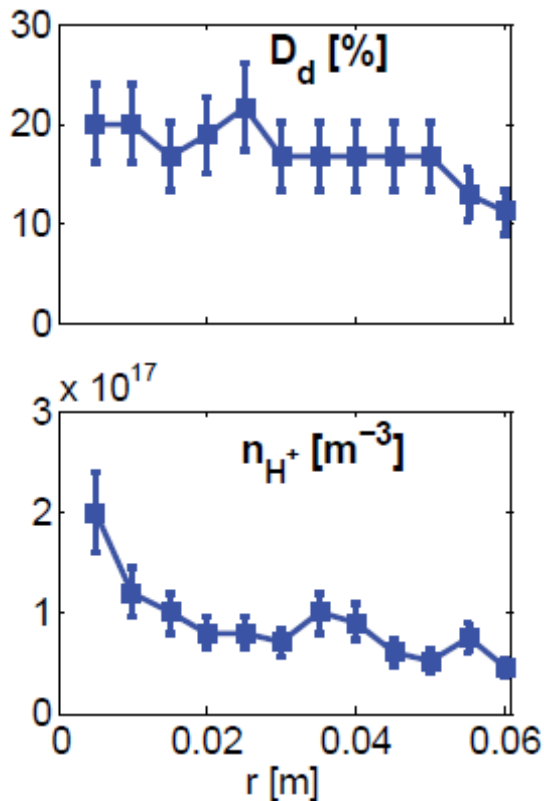

Ratio atomic/molec.
density

$$D_d = \frac{f}{f + 2}$$

$$D_i = \frac{n_e}{n_H + n_{H_2}}$$

edge

Beam intensity \leftarrow
(CRDS)

Binding energy 0.75 eV

\rightarrow Electron current
LP-aided PD

Negative hydrogen

L-shaped LP

Ni-YAG laser
200mJ
10 Hz
6ns pulse

H^- shell @ ~ 4.5 cm

HR mirror

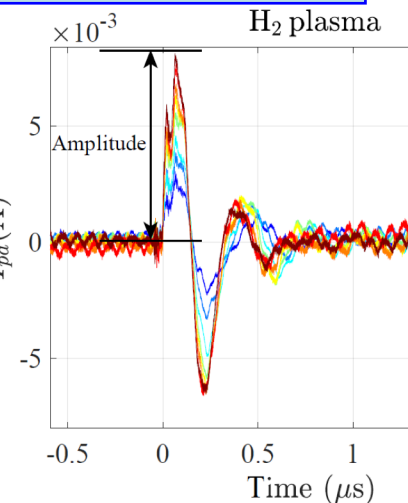
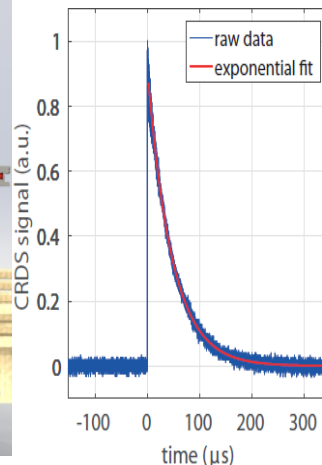

R. Agnello et al., Rev. Sci. Instrum. 89, 103504 (2018)

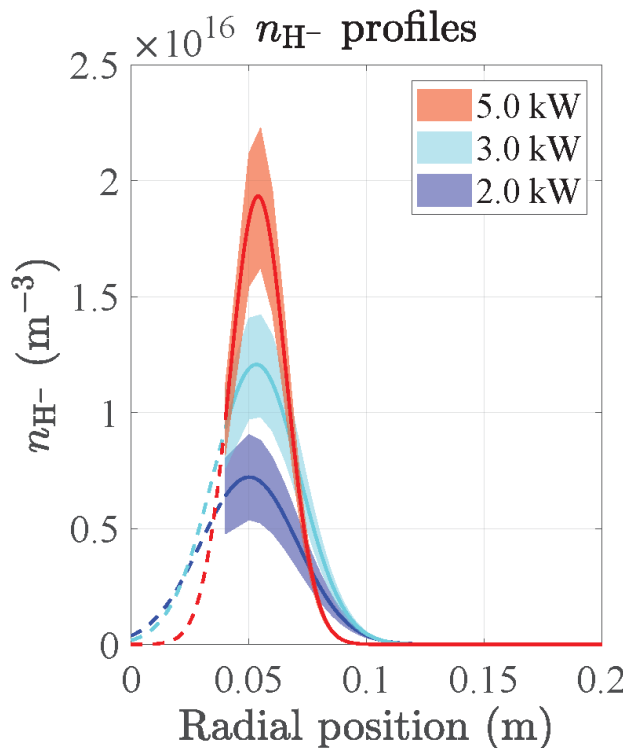

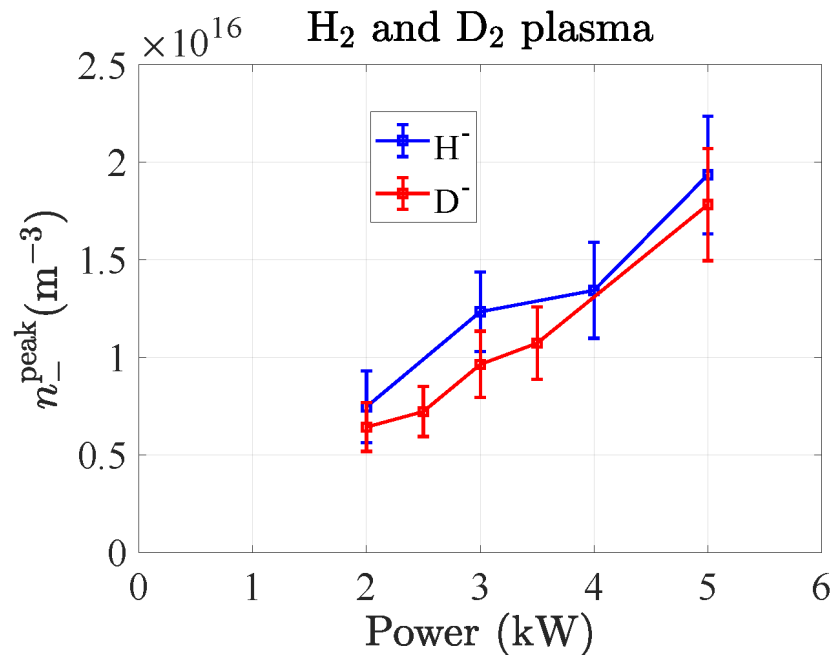
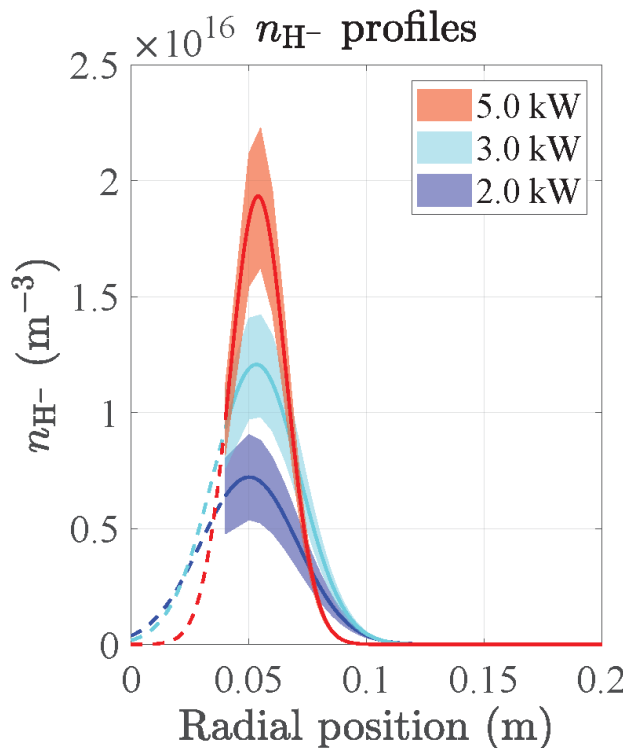

- Helicon waves in RAID
- Physics of negative ions in H₂/D₂ plasmas
 - ✓ Experimental measurements: Optical emission spectroscopy (OES), Laser-based diagnostics
 - ✓ A fluid model for H₂ plasmas
- Take home message: resonant antennas produce helicon plasmas characterized by a substantial negative ion population mostly generated by dissociative attachment on vibrationally excited molecules

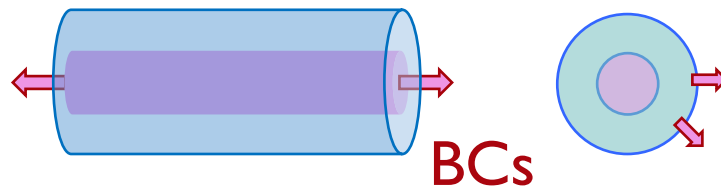

Continuity

$$\frac{\partial n_s}{\partial t} + \nabla \bar{\Gamma}_s = S_s - L_s$$

Momentum

$$m_s n_s \left[\frac{\partial \bar{v}_s}{\partial t} + (\bar{v}_s \cdot \nabla) \bar{v}_s \right] = q_s n_s (\bar{E} + \bar{v}_s \times \bar{B}) - \nabla \bar{P} - m_s n_s \mathbf{v}_s \mathbf{v}_s$$

Poisson

$$\varepsilon_0 \nabla^2 V = - \sum_s q_s (n_s - n_e)$$

Electrons

→ Experimental profiles of T_e and n_e

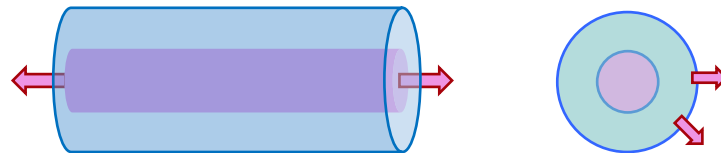

Continuity

$$\frac{\partial n_s}{\partial t} + \nabla \bar{\Gamma}_s = \underbrace{S_s}_{\text{Sources}} - \underbrace{L_s}_{\text{Losses}} \quad s = \text{H}^-, \text{H}^+, \text{H}_2^+, \text{H}_3^+$$

Momentum

$$m_s n_s \left[\frac{\partial \bar{v}_s}{\partial t} + (\bar{v}_s \cdot \nabla) \bar{v}_s \right] = q_s n_s (\bar{E} + \bar{v}_s \times \bar{B}) - \nabla \bar{P} - m_s n_s \mathbf{v}_s \mathbf{v}_s$$

Poisson

$$\varepsilon_0 \nabla^2 V = - \sum_s q_s (n_s - n_e)$$

Electrons

→ Experimental profiles of T_e and n_e

Reaction	Rate coefficient [m^3s^{-1}]
$\text{e} + \text{H}_2 \rightarrow \text{H}_2^+ + 2\text{e}$	$k_1 = 7.27 \cdot 10^{-15} T_e^{0.549} e^{-15.5/(T_e-0.001)} + 1.37 \cdot 10^{-14} T_e^{-0.557} e^{-20.3/T_e}$
$\text{e} + \text{H}_2 \rightarrow 2\text{H} + \text{e}$	$k_1 = 1.54 \cdot 10^{-14} T_e^{0.06} e^{8.63/T_e} + 1.11 \cdot 10^{-13} T_e^{-0.813} e^{-13.4/T_e}$
$\text{e} + \text{H}_2 \rightarrow \text{H} + \text{H}^-$	$k_{\dots} = 4.43 \cdot 10^{-17} T_e^{-1.29} e^{-11.7/(T_e+0.158)} + 1.33 \cdot 10^{-19} T_e^{-1.39} e^{-3.77/T_e}$
$\text{e} + \text{H}_2(v = 1 - 14) \rightarrow \text{H} + \text{H}^-$	$k_{DA} = 1.92 \sigma_v^{(0)} \frac{T_e^{1/2}}{1+T_e/E_0} e^{-\frac{\Delta E_{kv}}{T_e}} \cdot \left[\frac{[E_{kv}]}{T_e} + \frac{1}{1+T_e/E_0} \right] \cdot (10^{-14})$
$\text{e} + \text{H} \rightarrow \text{H}^+ + 2\text{e}$	$k_4 = 9.74 \cdot 10^{-15} T_e^{-0.174} e^{-14.3/(T_e-0.001)} + 6.35 \cdot 10^{-15} T_e^{0.433} e^{-16.4/T_e}$
$\text{H} + \text{H}_2^+ \rightarrow \text{H}_2 + \text{H}^+$	$k_4 = 1.54 \cdot 10^{-14} T_e^{-0.859} e^{-4.61/(T_i-0.786)} + 1.64 \cdot 10^{-15} T_i^{-0.353} e^{-0.258/T_i}$
$\text{e} + \text{H}_2^+ \rightarrow \text{H} + \text{H}^+ + \text{e}$	$3.50 \cdot 10^{-13} T_e^{-1.25} e^{-3.19/(T_e-0.008)} + 1.77 \cdot 10^{-13} T_e^{-0.0924} e^{-3.04/T_e}$
$\text{e} + \text{H}_3^+ \rightarrow \text{H}_2^+ + \text{H}^-$	$1.93 \cdot 10^{-15} T_e^{-1.07} e^{-6.26/(T_e+0.131)} + 5.35 \cdot 10^{-17} T_e^{-0.371} e^{-2.07/T_e}$
$\text{H}_2 + \text{H}_2^+ \rightarrow \text{H} + \text{H}_3^+$	$6.29 \cdot 10^{-15} T_i^{-1.46} e^{-2.22/(T_i+0.356)} + 2.71 \cdot 10^{-16} T_e^{-1.30} e^{-0.317/T_i}$
$\text{H}^+ + \text{H}^- \rightarrow 2\text{H}$	$4.46 \cdot 10^{-14} T_i^{-0.281} + 1.26 \cdot 10^{-14} e^{-1.96/T_i}$
$\text{H}_2^+ + \text{H}^- \rightarrow \text{H}_2 + \text{H}$	$2.23 \cdot 10^{-14} T_i^{0.425} + 8.93 \cdot 10^{-14} T_i^{-0.261}$
$\text{H}_3^+ + \text{H}^- \rightarrow 0.5\text{H}_2 + 3\text{H}$	$1.70 \cdot 10^{-14} T_i^{0.313} + 5.75 \cdot 10^{-14} T_i^{-0.288}$
$\text{e} + \text{H}^- \rightarrow \text{H} + 2\text{e}$	$4.58 \cdot 10^{-13} T_e^{0.287} e^{-4.41/(T_e+0.117)} + 2.71 \cdot 10^{-14} T_e^{0.62} e^{-1.82/T_e}$
$\text{e} + \text{H}_3^+ \rightarrow 2\text{H} + \text{H}^+ + 2\text{e}$	$2.69 \cdot 10^{-13} T_e^{-0.245} e^{-15.6/(T_e+0.003)} + 1.01 \cdot 10^{-12} T_e^{-0.464} e^{-26.8/T_e}$
$\text{H}_2 + \text{H}^+ \rightarrow \text{H}_3^+ + \text{h}\nu$	$1.63 \cdot 10^{21}$
$\text{e} + \text{H}_2^+ \rightarrow 2\text{H}$	$2.29 \cdot 10^{-14} T_i^{-0.571} + 3.31 \cdot 10^{-15} T_i^{-0.152 T_e}$
$\text{e} + \text{H}_3^+ \rightarrow 3\text{H}$	$3.36 \cdot 10^{-15} T_e^{-0.716} + 3.73 \cdot 10^{-14} T_e^{-0.67} e^{6.40/T_e}$
$\text{e} + \text{H}_3^+ \rightarrow \text{H} + \text{H}_2$	$2.03 \cdot 10^{-15} (T_e^{-0.189} + 0.040 T_e^{-1.49}) + 5.57 \cdot 10^{-14} T_e^{1.23} e^{-6.21/T_e}$
$\text{H} + \text{H}^- \rightarrow \text{H}_2 + \text{e}$	$2.16 \cdot 10^{-13} T_i^{-1.89} e^{-12.7/(T_i+1.17)} + 1.30 \cdot 10^{-15} T_i^{-0.418} e^{-0.192/T_i}$
$\text{H}_2 + \text{H}^- \rightarrow \text{H} + \text{H}_2 + \text{e}$	$1.62 \cdot 10^{-16} T_i^{0.417} e^{-6.47/(T_i+0.132)} + 5.70 \cdot 10^{-16} T_i^{0.550} e^{-2.19/T_i}$
$\text{H} + \text{H}^- \rightarrow 2\text{H} + \text{e}$	$3.81 \cdot 10^{-15} T_i^{0.280} e^{-3.76/(T_i+0.626)} + 4.55 \cdot 10^{-16} T_i^{0.603} e^{-0.375/T_i}$
$\text{H}_2 + \text{H}^+ \rightarrow \text{H} + \text{H}_2^+$	$5.54 \cdot 10^{-16} T_i^{-0.453} e^{-3.26/(T_i-0.001)} + 5.98 \cdot 10^{-18} T_i^{-2.88} e^{-0.310/T_i}$
$\text{e} + \text{H} \rightarrow \text{H}^- + \text{h}\nu$	$5.75 \cdot 10^{-20} (T_e^{-0.0285} - 0.94 T_e^{-0.05}) + 6.54 \cdot 10^{-19} T_e^{-5.18} e^{-72.4/T_e}$

Reaction	Rate coefficient [m^3s^{-1}]
$\text{e} + \text{H}_2 \rightarrow \text{H}_2^+ + 2\text{e}$	$k_1 = 7.27 \cdot 10^{-15} T_e^{0.549} e^{-15.5/(T_e-0.001)} + 1.37 \cdot 10^{-14} T_e^{-0.557} e^{-20.3/T_e}$
$\text{e} + \text{H}_2 \rightarrow 2\text{H} + \text{e}$	$k_1 = 1.54 \cdot 10^{-14} T_e^{0.06} e^{8.63/T_e} + 1.11 \cdot 10^{-13} T_e^{-0.813} e^{-13.4/T_e}$
$\text{e} + \text{H}_2 \rightarrow \text{H} + \text{H}^-$	$k_{\dots} = 4.43 \cdot 10^{-17} T_e^{-1.29} e^{-11.7/(T_e+0.158)} + 1.33 \cdot 10^{-19} T_e^{-1.39} e^{-3.77/T_e}$
$\text{e} + \text{H}_2(v = 1 - 14) \rightarrow \text{H} + \text{H}^-$	$k_{DA} = 1.92 \sigma_v^{(0)} \frac{T_e^{1/2}}{1+T_e/E_0} e^{-\frac{\Delta E_{Hv}}{T_e}} \cdot \left[\frac{[E_{ikv}]}{T_e} + \frac{1}{1+T_e/E_0} \right] \cdot (10^{-14})$
$\text{e} + \text{H} \rightarrow \text{H}^+ + 2\text{e}$	$k_4 = 9.74 \cdot 10^{-15} T_e^{-0.174} e^{-14.3/(T_e-0.001)} + 6.35 \cdot 10^{-15} T_e^{0.433} e^{-16.4/T_e}$
$\text{H} + \text{H}_2^+ \rightarrow \text{H}_2 + \text{H}^+$	$k_4 = 1.54 \cdot 10^{-14} T_e^{-0.859} e^{-4.61/(T_i-0.786)} + 1.64 \cdot 10^{-15} T_i^{-0.353} e^{-0.258/T_i}$
$\text{e} + \text{H}_2^+ \rightarrow \text{H} + \text{H}^+ + \text{e}$	$3.50 \cdot 10^{-13} T_e^{-1.25} e^{-3.19/(T_e-0.008)} + 1.77 \cdot 10^{-13} T_e^{-0.0924} e^{-3.04/T_e}$
$\text{e} + \text{H}_3^+ \rightarrow \text{H}_2^+ + \text{H}^-$	$1.93 \cdot 10^{-15} T_e^{-1.07} e^{-6.26/(T_e+0.131)} + 5.35 \cdot 10^{-17} T_e^{-0.371} e^{-2.07/T_e}$
$\text{H}_2 + \text{H}_2^+ \rightarrow \text{H} + \text{H}_3^+$	$6.29 \cdot 10^{-15} T_i^{-1.46} e^{-2.22/(T_i+0.356)} + 2.71 \cdot 10^{-16} T_e^{-1.30} e^{-0.317/T_i}$
$\text{H}^+ + \text{H}^- \rightarrow 2\text{H}$	$4.46 \cdot 10^{-14} T_i^{-0.281} + 1.26 \cdot 10^{-14} e^{-1.96/T_i}$
$\text{H}_2^+ + \text{H}^- \rightarrow \text{H}_2 + \text{H}$	$2.23 \cdot 10^{-14} T_i^{0.425} + 8.93 \cdot 10^{-14} T_i^{-0.261}$
$\text{H}_3^+ + \text{H}^- \rightarrow 0.5\text{H}_2 + 3\text{H}$	$1.70 \cdot 10^{-14} T_i^{0.313} + 5.75 \cdot 10^{-14} T_i^{-0.288}$
$\text{e} + \text{H}^- \rightarrow \text{H} + 2\text{e}$	$4.58 \cdot 10^{-13} T_e^{0.287} e^{-4.41/(T_e+0.117)} + 2.71 \cdot 10^{-14} T_e^{0.62} e^{-1.82/T_e}$
$\text{e} + \text{H}_3^+ \rightarrow 2\text{H} + \text{H}^+ + 2\text{e}$	$2.69 \cdot 10^{-13} T_e^{-0.245} e^{-15.6/(T_e+0.003)} + 1.01 \cdot 10^{-12} T_e^{-0.464} e^{-26.8/T_e}$
$\text{H}_2 + \text{H}^+ \rightarrow \text{H}_3^+ + \text{h}\nu$	$1.63 \cdot 10^{21}$
$\text{e} + \text{H}_2^+ \rightarrow 2\text{H}$	$2.29 \cdot 10^{-14} T_i^{-0.571} + 3.31 \cdot 10^{-15} T_i^{-0.152 T_e}$
$\text{e} + \text{H}_3^+ \rightarrow 3\text{H}$	$3.36 \cdot 10^{-15} T_e^{-0.716} + 3.73 \cdot 10^{-14} T_e^{-0.67} e^{6.40/T_e}$
$\text{e} + \text{H}_3^+ \rightarrow \text{H} + \text{H}_2$	$2.03 \cdot 10^{-15} (T_e^{-0.189} + 0.040 T_e^{-1.49}) + 5.57 \cdot 10^{-14} T_e^{1.23} e^{-6.21/T_e}$
$\text{H} + \text{H}^- \rightarrow \text{H}_2 + \text{e}$	$2.16 \cdot 10^{-13} T_i^{-1.89} e^{-12.7/(T_i+1.17)} + 1.30 \cdot 10^{-15} T_i^{-0.418} e^{-0.192/T_i}$
$\text{H}_2 + \text{H}^- \rightarrow \text{H} + \text{H}_2 + \text{e}$	$1.62 \cdot 10^{-16} T_i^{-0.417} e^{-6.47/(T_i+0.132)} + 5.70 \cdot 10^{-16} T_i^{0.550} e^{-2.19/T_i}$
$\text{H} + \text{H}^- \rightarrow 2\text{H} + \text{e}$	$3.81 \cdot 10^{-15} T_i^{0.280} e^{-3.76/(T_i+0.626)} + 4.55 \cdot 10^{-16} T_i^{0.603} e^{-0.375/T_i}$
$\text{H}_2 + \text{H}^+ \rightarrow \text{H} + \text{H}_3^+$	$5.54 \cdot 10^{-16} T_i^{-0.453} e^{-3.26/(T_i-0.001)} + 5.98 \cdot 10^{-18} T_i^{-2.88} e^{-0.310/T_i}$
$\text{e} + \text{H} \rightarrow \text{H}^- + \text{h}\nu$	$5.75 \cdot 10^{-20} (T_e^{-0.0285} - 0.94 T_e^{-0.05}) + 6.54 \cdot 10^{-19} T_e^{-5.18} e^{-72.4/T_e}$

Dissociative Attachment

Ion/pair formation

Electron Attachment 26

Reaction	Rate coefficient [m^3s^{-1}]
$e + \text{H}_2 \rightarrow \text{H}_2^+ + 2e$	$k_1 = 7.27 \cdot 10^{-15} T_e^{0.549} e^{-15.5/(T_e-0.001)} + 1.37 \cdot 10^{-14} T_e^{-0.557} e^{-20.3/T_e}$
$e + \text{H}_2 \rightarrow 2\text{H} + e$	$k_1 = 1.54 \cdot 10^{-14} T_e^{0.06} e^{8.63/T_e} + 1.11 \cdot 10^{-13} T_e^{-0.813} e^{-13.4/T_e}$
$e + \text{H}_2 \rightarrow \text{H} + \text{H}^-$	$k_{\dots} = 4.43 \cdot 10^{-17} T_e^{-1.29} e^{-11.7/(T_e+0.158)} + 1.33 \cdot 10^{-19} T_e^{-1.39} e^{-3.77/T_e}$
$e + \text{H}_2(v = 1 - 14) \rightarrow \text{H} + \text{H}^-$	$k_{DA} = 1.92 \sigma_v^{(0)} \frac{T_e^{1/2}}{1+T_e/E_0} e^{-\frac{\Delta E_{h\nu}}{T_e}} \cdot \left[\frac{[E_{ih\nu}]}{T_e} + \frac{1}{1+T_e/E_0} \right] \cdot (10^{-14})$
$e + \text{H} \rightarrow \text{H}^+ + 2e$	$k_4 = 9.74 \cdot 10^{-15} T_e^{-0.174} e^{-14.3/(T_e-0.001)} + 6.35 \cdot 10^{-15} T_e^{0.433} e^{-16.4/T_e}$
$\text{H} + \text{H}_2^+ \rightarrow \text{H}_2 + \text{H}^+$	$k_4 = 1.54 \cdot 10^{-14} T_e^{-0.859} e^{-4.61/(T_i-0.786)} + 1.64 \cdot 10^{-15} T_i^{-0.353} e^{-0.258/T_i}$
$e + \text{H}_2^+ \rightarrow \text{H} + \text{H}^+ + e$	$3.50 \cdot 10^{-13} T_e^{-1.25} e^{-3.19/(T_e-0.008)} + 1.77 \cdot 10^{-13} T_e^{-0.0924} e^{-3.04/T_e}$
$e + \text{H}_3^+ \rightarrow \text{H}_2^+ + \text{H}^-$	$1.93 \cdot 10^{-15} T_e^{-1.07} e^{-6.26/(T_e+0.131)} + 5.35 \cdot 10^{-17} T_e^{-0.371} e^{-2.07/T_e}$
$\text{H}_2 + \text{H}_3^+ \rightarrow \text{H} + \text{H}_3^+$	$6.29 \cdot 10^{-15} T_i^{-1.46} e^{-2.22/(T_i+0.356)} + 2.71 \cdot 10^{-16} T_e^{-1.30} e^{-0.317/T_i}$
$\text{H}^+ + \text{H}^- \rightarrow 2\text{H}$	$4.46 \cdot 10^{-14} T_i^{-0.281} + 1.26 \cdot 10^{-14} e^{-1.96/T_i}$
$\text{H}_2^+ + \text{H}^- \rightarrow \text{H}_2 + \text{H}$	$2.23 \cdot 10^{-14} T_i^{0.425} + 8.93 \cdot 10^{-14} T_i^{-0.261}$
$\text{H}_3^+ + \text{H}^- \rightarrow 0.5\text{H}_2 + 3\text{H}$	$1.70 \cdot 10^{-14} T_i^{0.313} + 5.75 \cdot 10^{-14} T_i^{-0.288}$
$e + \text{H}^- \rightarrow \text{H} + 2e$	$4.58 \cdot 10^{-13} T_e^{0.287} e^{-4.41/(T_e+0.117)} + 2.71 \cdot 10^{-14} T_e^{0.62} e^{-1.82/T_e}$
$e + \text{H}_3^+ \rightarrow 2\text{H} + \text{H}^+ + 2e$	$2.69 \cdot 10^{-13} T_e^{-0.243} e^{-13.0/(T_e+0.005)} + 1.01 \cdot 10^{-12} T_e^{-0.404} e^{-20.8/T_e}$
$\text{H}_2 + \text{H}^+ \rightarrow \text{H}_3^+ + \text{h}\nu$	$1.63 \cdot 10^{21}$
$e + \text{H}_2^+ \rightarrow 2\text{H}$	$2.29 \cdot 10^{-14} T_i^{-0.571} + 3.31 \cdot 10^{-15} T_i^{-0.152 T_e}$
$e + \text{H}_3^+ \rightarrow 3\text{H}$	$3.36 \cdot 10^{-15} T_e^{-0.716} + 3.73 \cdot 10^{-14} T_e^{-0.67} e^{6.40/T_e}$
$e + \text{H}_3^+ \rightarrow \text{H} + \text{H}_2$	$2.03 \cdot 10^{-15} (T_e^{-0.189} + 0.040 T_e^{-1.49}) + 5.57 \cdot 10^{-14} T_i^{1.23} e^{-6.21/T_e}$
$\text{H} + \text{H}^- \rightarrow \text{H}_2 + e$	$2.16 \cdot 10^{-13} T_i^{-1.89} e^{-12.7/(T_i+1.17)} + 1.30 \cdot 10^{-15} T_i^{-0.418} e^{-0.192/T_i}$
$\text{H}_2 + \text{H}^- \rightarrow \text{H} + \text{H}_2 + e$	$1.62 \cdot 10^{-16} T_i^{0.417} e^{-6.47/(T_i+0.132)} + 5.70 \cdot 10^{-16} T_i^{0.550} e^{-2.19/T_i}$
$\text{H} + \text{H}^- \rightarrow 2\text{H} + e$	$3.81 \cdot 10^{-15} T_i^{0.280} e^{-3.76/(T_i+0.626)} + 4.55 \cdot 10^{-16} T_i^{0.603} e^{-0.375/T_i}$
$\text{H}_2 + \text{H}^+ \rightarrow \text{H} + \text{H}_3^+$	$5.54 \cdot 10^{-16} T_i^{-0.453} e^{-3.26/(T_i-0.001)} + 5.98 \cdot 10^{-18} T_i^{-2.88} e^{-0.310/T_i}$
$e + \text{H} \rightarrow \text{H}^- + \text{h}\nu$	$5.75 \cdot 10^{-20} (T_e^{-0.0285} - 0.94 T_e^{-0.05}) + 6.54 \cdot 10^{-19} T_e^{-5.18} e^{-72.4/T_e}$

Dissociative Attachment

Ion/pair formation

Mutual Neutralization

Electron Detachment

Atom./Molec. Detachment

Electron Attachment 27

Reaction	Rate coefficient [m ³ s ⁻¹]
$e + H_2 \rightarrow H_2^+ + 2e$	$k_1 = 7.27 \cdot 10^{-15} T_e^{0.549} e^{-15.5/(T_e-0.001)} + 1.37 \cdot 10^{-14} T_e^{-0.557} e^{-20.3/T_e}$
$e + H_2 \rightarrow 2H + e$	$k_1 = 1.54 \cdot 10^{-14} T_e^{0.06} e^{8.63/T_e} + 1.11 \cdot 10^{-13} T_e^{-0.813} e^{-13.4/T_e}$
$e + H_2 \rightarrow H + H^-$	$k_{\dots} = 4.43 \cdot 10^{-17} T_e^{-1.29} e^{-11.7/(T_e+0.158)} + 1.33 \cdot 10^{-19} T_e^{-1.39} e^{-3.77/T_e}$
$e + H_2(v = 1 - 14) \rightarrow H + H^-$	$k_{DA} = 1.92 \sigma_v^{(0)} \frac{T_e^{1/2}}{1+T_e/E_0} e^{-\frac{\Delta E_{Hv}}{T_e}} \cdot \left[\frac{[E_{ikv}]}{T_e} + \frac{1}{1+T_e/E_0} \right] \cdot (10^{-14})$
$e + H \rightarrow H^+ + 2e$	$k_4 = 9.74 \cdot 10^{-15} T_e^{-0.174} e^{-14.3/(T_e-0.001)} + 6.35 \cdot 10^{-15} T_e^{0.433} e^{-16.4/T_e}$
$H + H_2^+ \rightarrow H_2 + H^+$	$k_4 = 1.54 \cdot 10^{-14} T_e^{-0.859} e^{-4.61/(T_i-0.786)} + 1.64 \cdot 10^{-15} T_i^{-0.353} e^{-0.258/T_i}$
$e + H_2^+ \rightarrow H + H^+ + e$	$3.50 \cdot 10^{-13} T_e^{-1.25} e^{-3.19/(T_e-0.008)} + 1.77 \cdot 10^{-13} T_e^{-0.0924} e^{-3.04/T_e}$
$e + H_3^+ \rightarrow H_2^+ + H^-$	$1.93 \cdot 10^{-15} T_e^{-1.07} e^{-6.26/(T_e+0.131)} + 5.35 \cdot 10^{-17} T_e^{-0.371} e^{-2.07/T_e}$
$H_2 + H_3^+ \rightarrow H + H_3^+$	$6.29 \cdot 10^{-15} T_i^{-1.46} e^{-2.22/(T_i+0.356)} + 2.71 \cdot 10^{-16} T_e^{-1.30} e^{-0.317/T_i}$
$H^+ + H^- \rightarrow 2H$	$4.46 \cdot 10^{-14} T_i^{-0.281} + 1.26 \cdot 10^{-14} e^{-1.96/T_i}$
$H_2^+ + H^- \rightarrow H_2 + H$	$2.23 \cdot 10^{-14} T_i^{0.425} + 8.93 \cdot 10^{-14} T_i^{-0.261}$
$H_3^+ + H^- \rightarrow 0.5H_2 + 3H$	$1.70 \cdot 10^{-14} T_i^{0.313} + 5.75 \cdot 10^{-14} T_i^{-0.288}$
$e + H^- \rightarrow H + 2e$	$4.58 \cdot 10^{-13} T_e^{0.287} e^{-4.41/(T_e+0.117)} + 2.71 \cdot 10^{-14} T_e^{0.62} e^{-1.82/T_e}$
$e + H_3^+ \rightarrow 2H + H^+ + 2e$	$2.69 \cdot 10^{-13} T_e^{-0.243} e^{-13.0/(T_e+0.003)} + 1.01 \cdot 10^{-12} T_e^{-0.404} e^{-20.8/T_e}$
$H_2 + H^+ \rightarrow H_3^+ + hv$	$1.63 \cdot 10^{21}$
$e + H_2^+ \rightarrow 2H$	$2.29 \cdot 10^{-14} T_i^{-0.571} + 3.31 \cdot 10^{-15} T_i^{-0.152 T_e}$
$e + H_3^+ \rightarrow 3H$	$3.36 \cdot 10^{-15} T_e^{-0.716} + 3.73 \cdot 10^{-14} T_e^{-0.67} e^{6.40/T_e}$
$e + H_3^+ \rightarrow H + H_2$	$2.03 \cdot 10^{-15} (T_e^{-0.189} + 0.040 T_e^{-1.49}) + 5.57 \cdot 10^{-14} T_i^{1.23} e^{-6.21/T_e}$
$H + H^- \rightarrow H_2 + e$	$2.16 \cdot 10^{-13} T_i^{-1.89} e^{-12.7/(T_i+1.17)} + 1.30 \cdot 10^{-15} T_i^{-0.418} e^{-0.192/T_i}$
$H_2 + H^- \rightarrow H + H_2 + e$	$1.62 \cdot 10^{-16} T_i^{0.417} e^{-6.47/(T_i+0.132)} + 5.70 \cdot 10^{-16} T_i^{0.550} e^{-2.19/T_i}$
$H + H^- \rightarrow 2H + e$	$3.81 \cdot 10^{-15} T_i^{0.280} e^{-3.76/(T_i+0.626)} + 4.55 \cdot 10^{-16} T_i^{0.603} e^{-0.375/T_i}$
$H_2 + H^+ \rightarrow H + H_3^+$	$5.54 \cdot 10^{-16} T_i^{-0.453} e^{-3.26/(T_i-0.001)} + 5.98 \cdot 10^{-18} T_i^{-2.88} e^{-0.310/T_i}$
$e + H \rightarrow H^- + hv$	$5.75 \cdot 10^{-20} (T_e^{-0.0285} - 0.94 T_e^{-0.05}) + 6.54 \cdot 10^{-19} T_e^{-5.18} e^{-72.4/T_e}$

Dissociative Attachment

$$S_{H^-} = n_e n_{H_2(v)} k(T_e, T_{H_2(v)})$$

Reaction	Rate coefficient [m^3s^{-1}]
$e + \text{H}_2 \rightarrow \text{H}_2^+ + 2e$	$k_1 = 7.27 \cdot 10^{-15} T_e^{0.549} e^{-15.5/(T_e-0.001)} + 1.37 \cdot 10^{-14} T_e^{-0.557} e^{-20.3/T_e}$
$e + \text{H}_2 \rightarrow 2\text{H} + e$	$k_1 = 1.54 \cdot 10^{-14} T_e^{0.06} e^{8.63/T_e} + 1.11 \cdot 10^{-13} T_e^{-0.813} e^{-13.4/T_e}$
$e + \text{H}_2 \rightarrow \text{H} + \text{H}^-$	$k_{\dots} = 4.43 \cdot 10^{-17} T_e^{-1.29} e^{-11.7/(T_e+0.158)} + 1.33 \cdot 10^{-19} T_e^{-1.39} e^{-3.77/T_e}$
$e + \text{H}_2(v=1-14) \rightarrow \text{H} + \text{H}^-$	$k_{DA} = 1.92 \sigma_v^{(0)} \frac{T_e^{1/2}}{1+T_e/E_0} e^{-\frac{\Delta E_{Hv}}{T_e}} \cdot \left[\frac{E_{ikv}}{T_e} + \frac{1}{1+T_e/E_0} \right] \cdot (10^{-14})$
$e + \text{H} \rightarrow \text{H}^+ + 2e$	$k_4 = 9.74 \cdot 10^{-15} T_e^{-0.174} e^{-14.3/(T_e-0.001)} + 6.35 \cdot 10^{-15} T_e^{0.433} e^{-16.4/T_e}$
$\text{H} + \text{H}_2^+ \rightarrow \text{H}_2 + \text{H}^+$	$k_4 = 1.54 \cdot 10^{-14} T_e^{-0.859} e^{-4.61/(T_i-0.786)} + 1.64 \cdot 10^{-15} T_i^{-0.353} e^{-0.258/T_i}$
$e + \text{H}_2^+ \rightarrow \text{H} + \text{H}^+ + e$	$3.50 \cdot 10^{-13} T_e^{-1.25} e^{-3.19/(T_e-0.008)} + 1.77 \cdot 10^{-13} T_e^{-0.0924} e^{-3.04/T_e}$
$e + \text{H}_3^+ \rightarrow \text{H}_2^+ + \text{H}^-$	$1.93 \cdot 10^{-15} T_e^{-1.07} e^{-6.26/(T_e+0.131)} + 5.35 \cdot 10^{-17} T_e^{-0.371} e^{-2.07/T_e}$
$\text{H}_2 + \text{H}_3^+ \rightarrow \text{H} + \text{H}_3^+$	$6.29 \cdot 10^{-15} T_i^{-1.46} e^{-2.22/(T_i+0.356)} + 2.71 \cdot 10^{-16} T_e^{-1.30} e^{-0.317/T_i}$
$\text{H}^+ + \text{H}^- \rightarrow 2\text{H}$	$4.46 \cdot 10^{-14} T_i^{-0.281} + 1.26 \cdot 10^{-14} e^{-1.96/T_i}$
$\text{H}_2^+ + \text{H}^- \rightarrow \text{H}_2 + \text{H}$	$2.23 \cdot 10^{-14} T_i^{0.425} + 8.93 \cdot 10^{-14} T_i^{-0.261}$
$\text{H}_3^+ + \text{H}^- \rightarrow 0.5\text{H}_2 + 3\text{H}$	$1.70 \cdot 10^{-14} T_i^{0.313} + 5.75 \cdot 10^{-14} T_i^{-0.288}$
$e + \text{H}^- \rightarrow \text{H} + 2e$	$4.58 \cdot 10^{-13} T_e^{0.287} e^{-4.41/(T_e+0.117)} + 2.71 \cdot 10^{-14} T_e^{0.62} e^{-1.82/T_e}$
$e + \text{H}_3^+ \rightarrow 2\text{H} + \text{H}^+ + 2e$	$2.69 \cdot 10^{-13} T_e^{-0.243} e^{-13.0/(T_e+0.005)} + 1.01 \cdot 10^{-12} T_e^{-0.404} e^{-20.8/T_e}$
$\text{H}_2 + \text{H}^+ \rightarrow \text{H}_3^+ + \text{h}\nu$	$1.63 \cdot 10^{21}$
$e + \text{H}_2^+ \rightarrow 2\text{H}$	$2.29 \cdot 10^{-14} T_i^{-0.571} + 3.31 \cdot 10^{-15} T_i^{-0.152} T_e$
$e + \text{H}_3^+ \rightarrow 3\text{H}$	$3.36 \cdot 10^{-15} T_e^{-0.716} + 3.73 \cdot 10^{-14} T_e^{-0.67} e^{6.40/T_e}$
$e + \text{H}_3^+ \rightarrow \text{H} + \text{H}_2$	$2.03 \cdot 10^{-15} (T_e^{-0.189} + 0.040 T_e^{-1.49}) + 5.57 \cdot 10^{-14} T_e^{1.23} e^{-6.21/T_e}$
$\text{H} + \text{H}^- \rightarrow \text{H}_2 + e$	$2.16 \cdot 10^{-13} T_i^{-1.89} e^{-12.7/(T_i+1.17)} + 1.30 \cdot 10^{-15} T_i^{-0.418} e^{-0.192/T_i}$
$\text{H}_2 + \text{H}^- \rightarrow \text{H} + \text{H}_2 + e$	$1.62 \cdot 10^{-16} T_i^{0.417} e^{-6.47/(T_i+0.132)} + 5.70 \cdot 10^{-16} T_i^{0.550} e^{-2.19/T_i}$
$\text{H} + \text{H}^- \rightarrow 2\text{H} + e$	$3.81 \cdot 10^{-15} T_i^{0.280} e^{-3.76/(T_i+0.626)} + 4.55 \cdot 10^{-16} T_i^{0.603} e^{-0.375/T_i}$
$\text{H}_2 + \text{H}^+ \rightarrow \text{H} + \text{H}_3^+$	$5.54 \cdot 10^{-16} T_i^{-0.453} e^{-3.26/(T_i-0.001)} + 5.98 \cdot 10^{-18} T_i^{-2.88} e^{-0.310/T_i}$
$e + \text{H} \rightarrow \text{H}^- + \text{h}\nu$	$5.75 \cdot 10^{-20} (T_e^{-0.0285} - 0.94 T_e^{-0.05}) + 6.54 \cdot 10^{-19} T_e^{-5.18} e^{-72.4/T_e}$

Dissociative Attachment

$$S_{\text{H}^-} = n_e n_{\text{H}_2(v)} k(T_e, T_{\text{H}_2(v)})$$

MC PIC model of neutrals

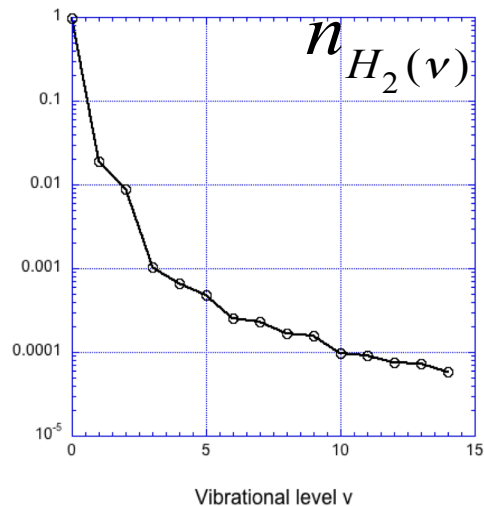

Simulations show the formation of H^- in good agreement with data

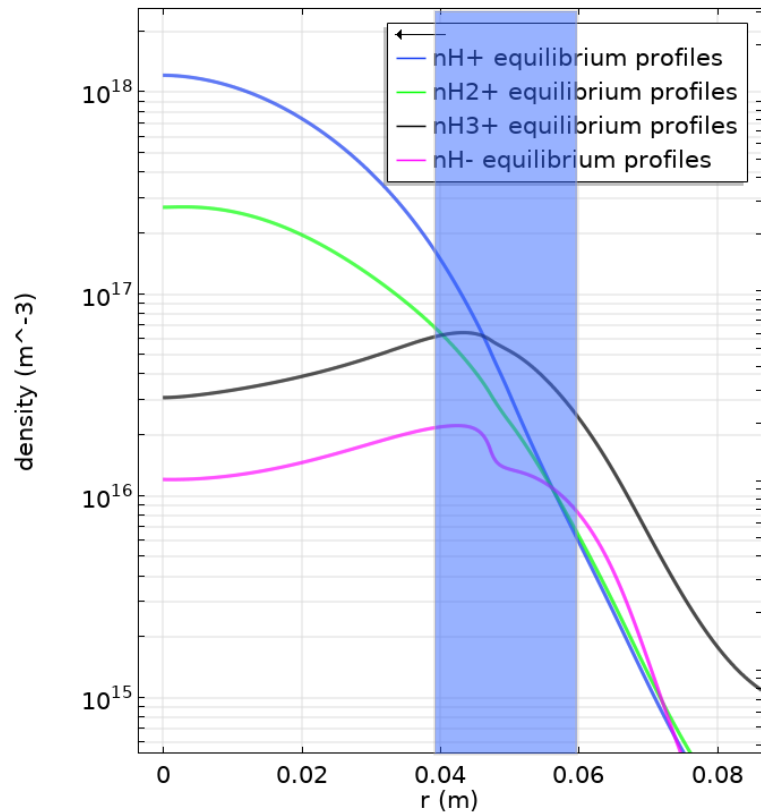

How is H^- produced and destroyed?

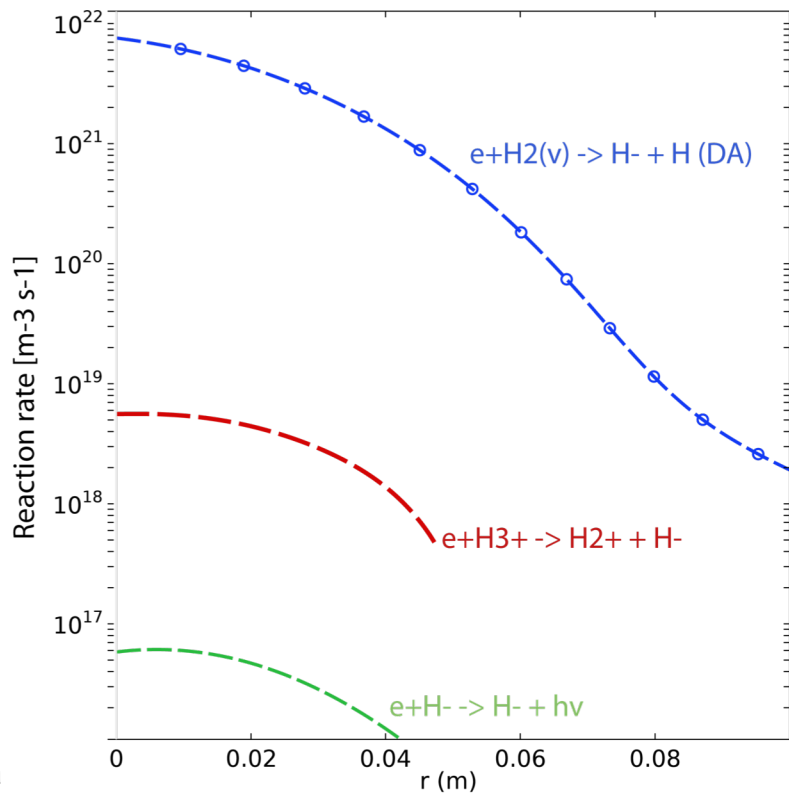

Dissociative attachment to $H_2(v)$ is by far the largest H^- production channel

How is H^- produced and destroyed?

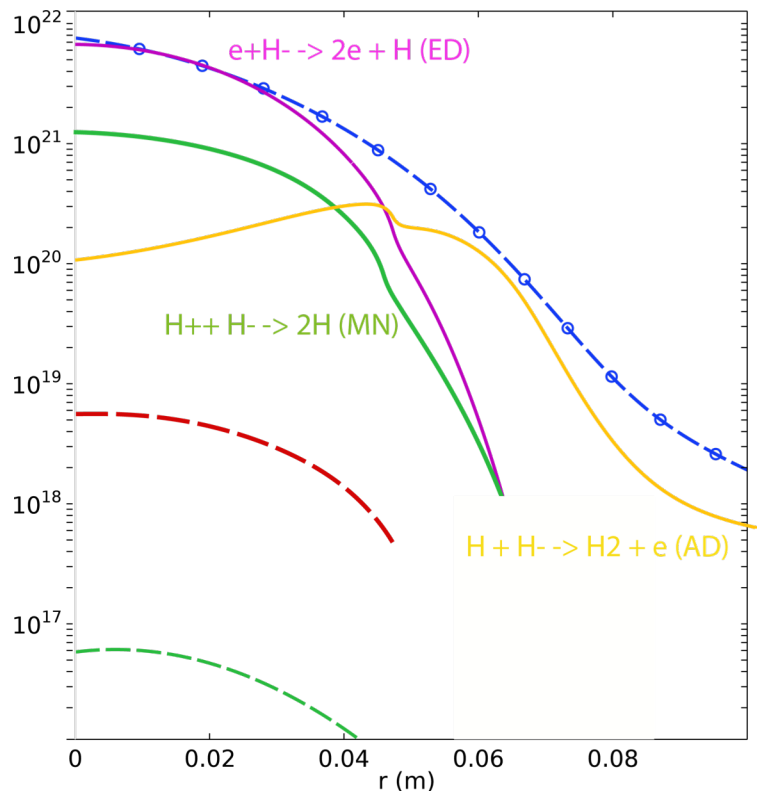

Dissociative attachment to $H_2(v)$ is by far the largest H^- production channel

In the center of the plasma column, hot electrons destroy H^- by electron detachment (ED) and mutual neutralization (MN)

At the edge the plasma column, atomic detachment (AD) destroys H^-

- In RAID, helicon waves generate high power, H_2/D_2 plasmas with a significant negative ion population
 - ✓ Full characterization of helicon waves
 - ✓ First combined use of CRDS and LP-laser photo-detachment
 - ✓ Fluid simulations
- Next: negative ion extraction

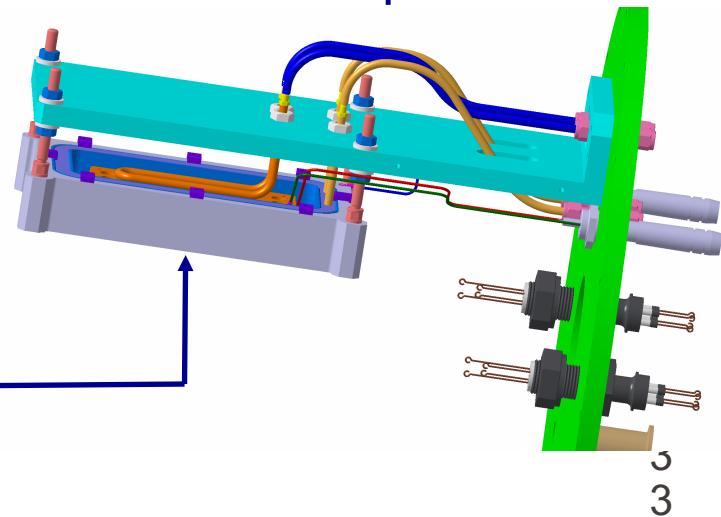

Constant pressure (0.3 Pa)

Atomic electronic states $n=1,2,3$
Filling pressure [Pa]

Molecules in electronic ground states with 15 vibrational level

Input: experimental T_e and n_e

