



HAL
open science

Formal Verification for Validation of PSEEL's PLC Program

Mohamed Niang, Philippot Alexandre, François Gellot, Raphaël Coupat,
Bernard Riera, Sébastien Lefebvre

► **To cite this version:**

Mohamed Niang, Philippot Alexandre, François Gellot, Raphaël Coupat, Bernard Riera, et al.. Formal Verification for Validation of PSEEL's PLC Program. 14th International Conference on Informatics in Control, Automation and Robotics (ICINCO), Jul 2017, Madrid, Spain. hal-03427253

HAL Id: hal-03427253

<https://hal.science/hal-03427253>

Submitted on 13 Nov 2021

HAL is a multi-disciplinary open access archive for the deposit and dissemination of scientific research documents, whether they are published or not. The documents may come from teaching and research institutions in France or abroad, or from public or private research centers.

L'archive ouverte pluridisciplinaire **HAL**, est destinée au dépôt et à la diffusion de documents scientifiques de niveau recherche, publiés ou non, émanant des établissements d'enseignement et de recherche français ou étrangers, des laboratoires publics ou privés.

Formal Verification for Validation of PSEEL's PLC Program

Mohamed NIANG^{1&2}, Alexandre PHILIPPOT¹, François GELLOT¹,
Raphaël COUPAT², Bernard RIERA¹, Sébastien LEFEBVRE²

¹*CRESTIC (EA3804), University of Reims Champagne Ardenne Moulin de la Housse,
BP 1039, 51687 Reims CEDEX 2, France*

²*IP.TE (CES), Direction de l'ingénierie, Société Nationale des Chemins de fer Français,
6 avenue François Mitterrand – 93574 La plaine Saint Denis CEDEX, France*

*mohamed.niang@etudiant.univ-reims.fr, {francois.gellot, alexandre.philippot, bernard.riera}@univ-reims.fr,
{raphael.coupat, s.lefebvre}@reseau.sncf.fr*

Keywords: Model-checking, recipe book, factory tests, systems engineers, railways, safety.

Abstract: In order to keep its leadership in French rail market and to improve work conditions of its systems engineers during automation projects, the SNCF (French acronym for National Society of French Railways) wants to develop solutions increasing the productivity. One of these improvements focuses on the current methodology used by systems engineers to verify and validate PLC programs of electrical installations. This task remains one of the most important during an automation project because it is supposed to ensure installations safety, but it must be optimized. Through an industrial thesis financed by SNCF, the aim of this research project is to improve this method and reduce time validation of programs by providing a tool which will help systems engineers to verify and validate quickly and automatically PLC programs during any automation project, not necessarily during factory tests but directly from their office.

1 INTRODUCTION

In automated systems, most of accidents that occur in industry have been discovered to be the result of Programming errors (Mokadem et al., 2010). Therefore, verification of PLC program before its implementation remains a very important task during an automation project. This verification must concern both functional and safety parts. The first one ensures that the PLC programs meet the functional specifications, and the second one consists in verifying if the controlled system can be or not exposed to dangerous states leading to human and equipment damage. Nowadays, some verification and validation techniques like tests and simulation are available.

At SNCF, the system engineers apply currently these methods to validate the control command (programs and electrical cabinets' wiring) of PSEEL (Power Supply Equipment of the Electric Lines) by using a recipe book which contains a set of scenarios or sequential instructions. According to their know-how and experience during these last decades about their systems, they consider that a PSEEL's control command is valid once it satisfies the whole test.

The verification consists in executing manually each instruction contained in the recipe book during factory tests, and then comparing the obtained results with the expected ones. This verification is therefore not automatic, and requires too much time because of the length of tests (almost 100 pages of instructions). Moreover, although it was used to validate PLC programs for several decades, this method is not efficient to check formally safety part of PLC programs insofar as it verifies only if PLC programs meet the requirements specifications.

Our first task in this work is to optimize this current methodology of verification by making it faster and automatic with the use of a model-checker. Then we propose an exhaustive method which will be used to verify the safety part of PLC programs.

After a presentation of general context in section 2, we detail the principle of our methodology and illustrate it through an application in section 3. Exhaustiveness of recipe book is studied in section

4, and section 5 introduces a solution for automatic generation of models used for programs verification. We conclude finally this paper and propose some work prospects in section 6.

2 GENERAL CONTEXT

The PSEEL are the electrical supply points of the electrified lines, called catenaries. Their role is to transform, to supply, and to rectifier in the case of DC supply, the tension of the High-Voltage (HV) network into compatible tension with traction units (1500 V DC or 25kV AC). They are composed of sub-systems (sSys) like Transformer Group, Track feeder, and common, and each of these sub-systems is composed of elements of sub-Systems (ElSys) like switch, circuit breaker, and so on (Figure 1). These electrical systems are subject to strict standards of railway safety (EN 50126, 2012) (IEC 60870-4, 2013).

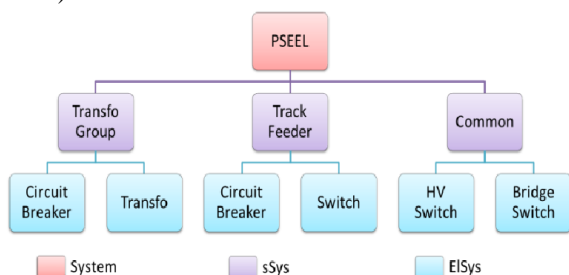

Figure 1: Decomposition of PSEEL.

The PSEEL are distributed automated systems whose control command can be done either locally or remotely in a centralized control station named Central Sub-Stations (CSS).

The recipe book represents for SNCF the main reference for validation of PSEEL's control command systems since many years. It contains several scenarios that systems engineers execute on PSEEL and analyze its behavior in order to validate or not its control command. An example of a test scenario is presented in Table 1.

Table 1: Example of one test scenario in recipe book.

Circuit breaker's reaction after overcurrent	
<u>Initial conditions</u>	
Switch SG1 and Circuit breaker DG1 closed	
High Voltage presence	
No defaults	
<u>Tests</u>	
Instructions	Expected results
1. Create an overcurrent default	1. DG1 opening, input "Imax" activated
2. Close circuit breaker DG1	2. Nothingness
3. Stop overcurrent default and close DG1	3. Input "Imax" deactivated, DG1 closed

During an automation project, the recipe book and the PLC programs are automatically generated with software named Odil (Coupat, 2014). For this, the systems engineers enter all inputs data of the system (like single line diagram of PSEEL, equipment configuration, inputs/outputs ...) and then, Odil generates automatically programs and recipe book. After a proofreading of these latter, they verify online the correctness of whole control command (PLC program and electrical cabinets) during factory tests, by executing all the scenarios of the recipe book on system. Moreover during factory tests, they need to connect devices simulators to cabinets (like switches and circuit breakers) in order to make tests possible. One major difficulty they can encounter during tests is that in case of an unsatisfied instruction in factory, they must analyze the problem and determine its cause (programming error or wiring error of electrical cabinets). For example in the test scenario described in Table 1, when the circuit breaker does not open after overcurrent (instruction N°1), there are two possible explanations:

- The information "Imax" is not received by the PLC (because the input is not wired for example);
- The information is received but the SFC program of the circuit breaker does not evolve (bad program).

Despite their experience, this diagnosis may remain long and complex in some cases. The main approach of our methodology consists in dividing the validation step into two parts: offline validation of PLC programs with model-checker Uppaal (Behrmann et al., 2002), and then online validation of electrical cabinets during factory tests with virtual commissioning. Thus, PLC programs can be validated earlier with Uppaal and before factory tests. Moreover, this validation step does not require physical devices simulators because they are now included in Uppaal models. From a model of PSEEL, PLC programs, and recipe book, Uppaal is

able to check automatically during the simulation if the PLC programs satisfy the recipe book. For this, the model-checker executes all scenarios of recipe book on the system, and verifies if there exists at least one instruction in the recipe book whose effect on the PSEEL does not correspond to the expected one. Then, simulation results will help to diagnose easily the problem if it exists, or otherwise to validate the PLC programs. The validation of electrical cabinets will be done online and also automatically, with the use of virtual commissioning connected to electrical cabinets (not presented in this paper). The advantage of this methodology is as follows: not only the validation of programs will be faster and automatic, but it will also facilitate the validation of electrical cabinets. In fact, once we implement valid PLC programs in the system, any encountered problem during factory tests would necessarily result from wiring errors of electrical cabinets. Another objective in this work is to propose with model-checking an exhaustive method which verifies the safety part of PLC programs. System modeling is the first step of our approach.

3 SYSTEM MODELING

In this section, we present and illustrate our methodology through its application on a transformer group (PSEEL’s sub-system). System modeling requires careful structural analysis of PSEEL and PLC programs because the models must have the same behavior as real system. The transformer group is controlled by one PLC, and is basically composed of circuit breakers, switches, and transformer. Its program’s outputs correspond to the orders sent to devices, and inputs are the observed faults on operative part and the devices’ states (opened or closed). The programs are designed in STRATON (www.copalp.com) using some of the standardized languages (IEC 61131-3, 2003) such as Ladder Diagram (LD), Sequential Function Chart (SFC) and Structured Text (ST). But in our Uppaal models, the whole program needs to be translated into ST because the model-checker cannot interpret the other languages. Whatever the programming language would be, each scan cycle includes three main phases: input reading, program execution and output updating.

3.1 Transformer Group Modeling

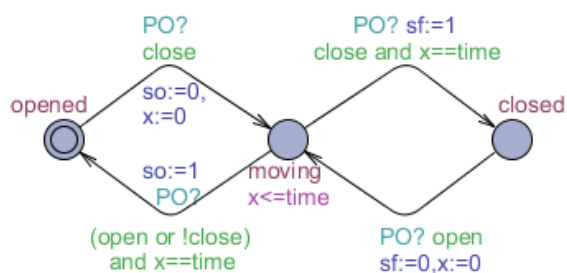

Figure 2: UPPAAL model of switch.

The variables “so” and “sf” (Figure 2) represent respectively the information “switch opened” and “switch closed”, and “close” (respectively “open”) represents closing order (respectively opening order) sent by the programs. The switch can reach three possible states: opened (**so=true** and **sf=false**), moving (**so=false** and **sf=false**), and closed (**so=false** and **sf=true**). Initially opened, it starts moving once it receives closing order from the program. Then, after a certain duration (**x==time**) it becomes fully closed if the order was still maintained, or otherwise returns to the initial state if closing order was released or if opening order was activated. The switch’s behaviour is practically the same when it receives opening order from closed state. We recall here that the order sent by operator is not directly received by the device, but rather by its SFC program which will apply it or not, if the program allows this action.

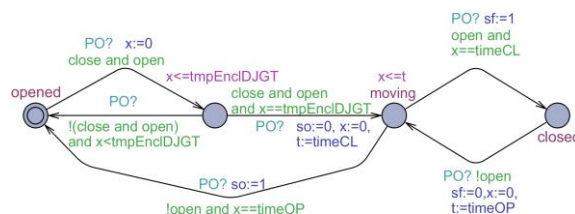

Figure 3: UPPAAL model of circuit breaker.

The model of a circuit breaker presented in Figure 3 has some particularities compared to switch model:

- To close the circuit breaker, the two orders (open and close) must be maintained simultaneously for a certain duration (**x==tmpEnclDJGT**);
- To open it, just release the opening order;
- Contrary to the switch, opening time (**timeOP**) is different from closing time (**timeCL**).

Note that although the transformer has continuous behaviour (magnetic, thermal...), we do not take it into account in its model. So we represent it as a structure of variables (observers, parameters, and observed faults) because these are the only information we need for this model:

```
struct {bool defBLQ, blocDef, defTemp, defBLQR,
blocDefRed, defTempRed, wdMicom, TcMC,
temp2TR, AMR, fuFuRC, AvDiode, imaxGT,
OoAbsUHT, OoDjAbsUHT, deblocGT, absUBarre,
presenceSGT, pres_Hexa; int tmpReencGT;} GT1;
```

3.2 Control Program Modeling

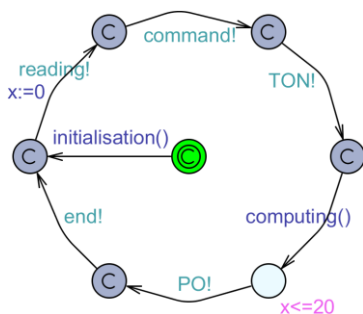

Figure 4: UPPAAL model of PLC cycle.

The model in Figure 4 synchronizes all the other models of the system thanks to broadcast channels. PLC cycle structured as a loop includes a clock x which measures the cycle time (equal to 20 time units here). Initialisation of SFC programs and parameters is required during the first PLC cycle. Then, the cycle is composed of 6 steps:

- Input reading (faults and devices' states)
- Command reading (sent by operators)
- Timers evolution (synchronised with **TON!** channel)
- Execution of main program (SFC programs update) followed by output writing;
- Evolution of operative part (channel **PO!**)
- End of cycle (channel **end!**)

To reduce states space, most of states are declared as committed so that time can elapse only during program execution. Therefore the duration of input acquisition and output emission is negligible.

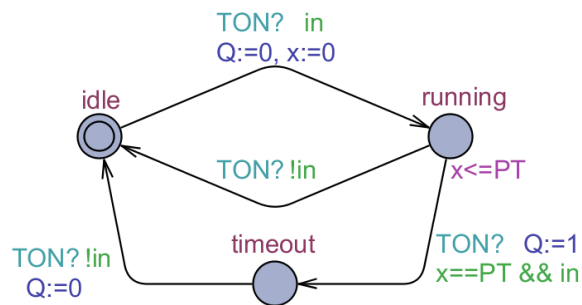

Figure 5: UPPAAL model of a TON block.

The control program contains timing operations, described by functional blocks called TON (Timer On-delay). Its behaviour is explained in IEC 61131-3 standard. This TON block has two input variables (boolean variable **in** to start or stop counting time, and time parameter **PT** which indicates the timing delay) and two output variables (boolean variable **Q** which equals 1 if the delay has expired, and time variable **x** which gives the time elapsed from the last rising edge of **in**). Initially **idle**, its location becomes **running** when the timer has been switched on, and **timeout** when the fixed delay (**PT**) has been reached. The model in Figure 5 has been inspired in (Mokadem et al., 2010).

Any SFC program can use more than two TON block in its different steps. So instead of using a TON block for any step, we declare only one TON block per SFC program. In fact, after a structural analysis of these SFC programs, we noticed that we can never have more than one step simultaneously activated. Thus, a single TON block can be used by all steps of one SFC program without any conflict. However, for two successive steps using the same TON, we must make sure that between the two steps' activation, the TON's output changes from 1 to 0. For this, we must define correctly the inputs **in** and **PT** of the TON block used by the SFC program. In the example described in Figure 6, both steps **x1** and **x2** use the same TON. When **x1** is activated, time starts elapsing until it reaches 500ms. Then, output **Q** and transition **ft1** change from 0 to 1, leading to **x2**'s activation and **x1**'s deactivation. Therefore, the input **in** (whose expression is shown in Figure 6) moves from 1 to 0 and resets the timer (thus output **Q** changes from 1 to 0 and input **PT** changes from 500ms to 1000ms). During the next PLC cycle, the value of **ft1** will be updated because the step **x1** is no more activated, so the input **in** will move again from 0 to 1 and time will start again elapsing for **x2**. But with these operations, we noticed a delay of one PLC scan time from **x2**'s activation to timer's restart. To compensate this

delay, we subtract it to the pre-set time of $x2$. This optimization will reduce the number of TON used, and consequently the space of reachable states.

The whole program is not represented in our model because some lines of code are only dedicated to send information to other PLC through network (Factory Instrumentation Protocol).

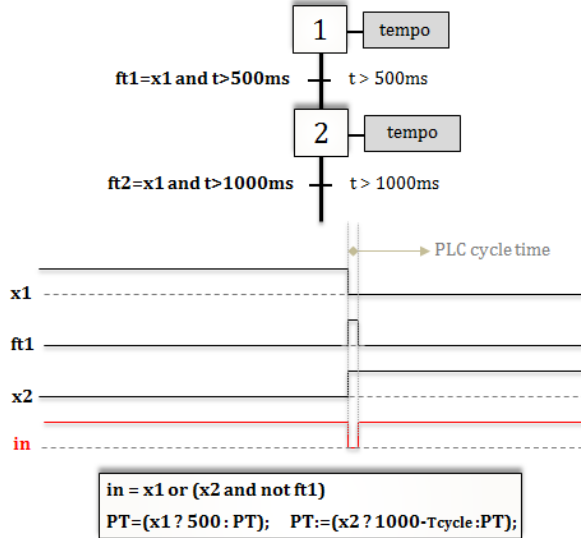

Figure 6: Example of TON's use in a SFC program.

So the control program is basically composed of:

- SFC block programs: which command the equipment like switches and circuits breakers. The structure of the SFC program depends on the kind of equipment.
- LD programs: where devices' states are read and all observed faults are collected and used to compute observers.

The SFC programs will be translated into Structured Text language (ST), using the classical algebraic representation of SFC (Machado et al., 2006). The LD programs will also be translated into ST language (Figure 7).

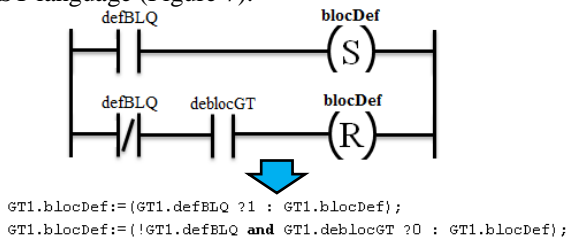

Figure 7: Example of LD programs translation into ST.

3.3 Recipe Book Modeling

After a structural analysis of recipe book, we realized that it could be translated into SFC programs (one per scenario) because it is composed of actions and transitions. In Figure 8 we present the translation of scenario described in Table 1. The variable "start elapsing" is dedicated to trigger a timer which counts the elapsed time in one step of the scenario ($x1$, $x2$, or $x3$ in this example). So if there is a step on which the elapsed time exceeds a certain value (which is not supposed to be reached if the program is valid), it will mean that program presents errors because the transition associated to that step cannot be satisfied.

This translation will be applied for all scenarios of transformer group's recipe book.

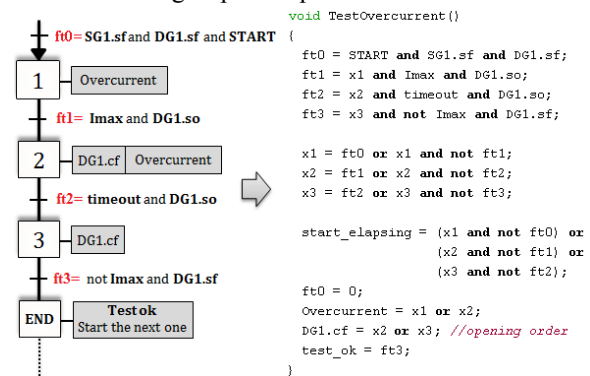

Figure 8: Translation of scenario into SFC program.

Then, the model described in Figure 9 will call and execute sequentially all scenarios. The recipe book's evolution state will be updated during any PLC scan time. Each state automaton of this model (except the initial and last ones) corresponds to one scenario. During simulation, one scenario can be executed only if the previous one (if it exists) was satisfied. Therefore the program is valid only if the final state automaton (named *valides* in Figure 9) is reachable, or if it does not exist a blocking instruction in recipe book.

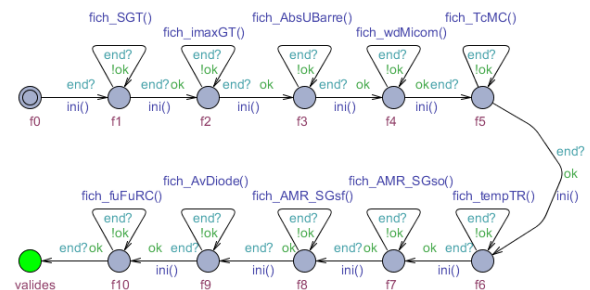

Figure 9: Uppal model of recipe book.

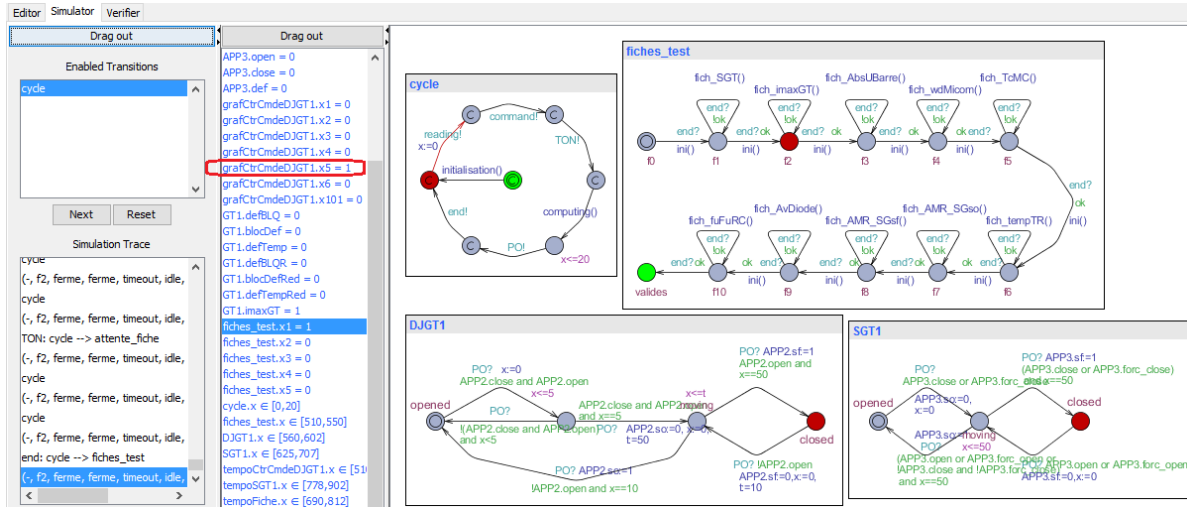

Figure 10: simulation view.

3.4 Simulation Results

To validate the PLC program, all scenarios must be executed and satisfied during simulation. For this, we can verify if the final state automaton is reachable by using the query:

$$E \diamond \text{recipe_book.valides} \quad (1)$$

However the model checker does not return any trace if (1) is not satisfied. Thus (1) is only useful to determine if programs are valid or not, but not sufficient for diagnosis. So instead of this property, we verify if there exists a blocking step of a scenario where the corresponding condition is not satisfied by using the query:

$$E \langle \rangle \text{time_step.timeout} \quad (2)$$

Time step is a timer which counts the elapsed time for any step of the recipe book. If (2) is satisfied, the model checker will return directly the scenario and blocking step on which simulation stopped. Moreover, by analysing the current state of programs, it will help for diagnosis. After a first simulation (see results in Table 2), we realized that (1) is satisfied and (2) is not: this is far from being a surprise because the program we used here has already been validated during factory tests.

In the following example, we used a modified program to verify if problems can be diagnosed during simulation. Table 2 presents simulation results, and gives the time and memory used for verification (on a windows machine with 4Gb RAM, Core i5).

Table 2: Simulation results.

	Property	result	time	memory
program valid	$E \langle \rangle \text{recipe_book.valides}$	satisfied	0.064 s	31Mb
	$E \langle \rangle \text{time_step.timeout}$	not satisfied	0.067 s	34Mb
program modified (Imax deleted)	$E \langle \rangle \text{recipe_book.valides}$	not satisfied	0.037 s	36Mb
	$E \langle \rangle \text{time_step.timeout}$	satisfied	0.037 s	36Mb

As expected, (1) is not satisfied for the modified program, but to diagnose the problem, it is not sufficient. So when we verify by using (2), the model-checker has shown that the instruction N°1 of overcurrent test is blocking (step **x1** of Figure 8) because the circuit breaker did not open after overcurrent. Moreover, when we analyse the current state of circuit breaker SFC program in simulation results (see in Figure 10), we notice that its evolution stopped in that moment on a step where it was waiting for opening order (step **x5** of SFC program **grafCtrCmdeDJGT1** in variables column of Figure 10). Thus, we conclude that the transition following that step is not correct because it did not take into account the overcurrent information. This result was expected because the expression “**or Imax**” was initially deleted from that transition. After correction and second simulation, the instruction N°2 of overcurrent test (transition **ft2** of Figure 8) is not satisfied because the circuit breaker started closing when it received that order whereas it should not. In fact, the circuit breaker must stay opened while overcurrent does not disappear. This result was also expected because the expression “**and not Imax**” was also deleted from SFC program’s transition. In that way, we can diagnose quickly and correct the whole program by referring

to the expected results of recipe book, and simulation does not require too much memory. Its efficiency has already been validated with some examples of wrong programs.

4 SAFETY PART VERIFICATION

Although recipe book has served to validate PSEEL’s programs for many decades, it is not sufficient to verify formally installations safety. In fact, the previous method does not study all the reachable states of system (meaning all the 2^{Ne} possible states, with Ne = number PSEEL’s sensors + number of received orders). Moreover, it has also been proved in (Coupat, 2014) with a specific PSEEL, that there exists one scenario (with low occurrence) not included in recipe book, but which can expose that PSEEL in dangerous state, meaning that the method is not exhaustive. So supposing that events like sending orders by operator or faults apparition can occur whenever on system, the principle is to check with Uppaal if each of these states is not dangerous (meaning does not violate a set of safety properties). Therefore recipe book will no more represent a reference of verification. We delete its model and we add two others ones that generate randomly faults (left side on Figure 11) and sending order (right side of Figure 11). With the first model, fault can take two possible boolean values (**true** or **false**), and with the second one a device’s SFC program can receive opening order from operator (**co=true** and **cf=false**), closing order (**co=false** and **cf= true**), or no order (**co=false** and **cf=false**). During a PLC cycle, an order sent by an operator would not have any effect on system if the SFC program of the targeted device was not in a step waiting for that order. Thus, to avoid ineffective orders and reduce states space, we added some guards in these models.

This method is more efficient than the first one because all the reachable states of system are browsed and studied, unlike the first method. And it can verify not only the safety part but also the functional correctness of PLC programs, according to the set of properties we verify.



Figure 11: Uppaal models of fault and sending order.

With a program already validated by recipe book, we have to verify with this second method if there exists at least a path which leads system to a dangerous state. In that case, it would mean that the recipe book does not contain all required tests, and is therefore insufficient to guarantee safety. Currently, the SNCF experts help us to determine all the dangerous states of PSEEL in order to define all safety properties and complete the verification. We can already verify its efficiency by applying it to the previous modified program. An example of dangerous state is that a blocking fault appears during 300ms without the circuit breaker opens:

```
E<>cycle.fin and TON_fault.timeout (3)
and DG1.sf
```

TON_fault is a timer which counts the elapsed time since fault’s apparition while circuit breaker stays closed. After simulation, we noticed that this state is reachable only if overcurrent fault appears for 300ms: that is obvious because the variable “**I_{max}**” was deleted from that SFC program.

This simulation requires more memory time (20.56s and 140Mb with (3)) because of states space increase, but this method is more efficient than the first one. All the errors detectable by recipe book are also detectable by this second method, meaning that the latter is also more exhaustive.

5 AUTOMATIC GENERATION OF UPPAAL MODELS

The methodology of formal verification must be applied for any new automation project. Because of heterogeneity of PSEEL and programs, systems engineers would be obliged to adapt Uppaal models according to installation’s structure, recipe book and program’s content. This additional task goes against our principle in this work because it increases time project. As for programs and recipe book, we propose to generate automatically with Odil the Uppaal file (*.xml) which contains all required inputs data (PSEEL models, programs, and recipe book). The methodology used to generate this xml file is not detailed in this paper, but presented in (Coupat, 2014). The xml file contains exactly the same information as for program and recipe book, but in a different language. After automatic generation, the systems engineers have just to import from Uppaal the generated xml file (for any sub-system of PSEEL), and execute it in order to analyse results and validate automatically programs, directly

from their office and not necessarily in factory. Some examples of xml files has been generated and used for simulation.

6 CONCLUSION

The main objective of this research work was to optimize validation step of PSEEL's PLC programs. The current method used by SNCF's systems engineers consists in testing online some scenarios in the program by using a recipe book, and validate programs if all tests are satisfied. The simulation is necessarily done after electrical cabinets' design and program's implementation in PLC, and requires too much times (one week at least) because tests are manual. Moreover, manual tests can imply human errors due to mental workload (Coupat et al., 2014). The proposed solution in this work aims to solve these problems insofar as programs validation is faster and automatic (recipe book of transformer group is browsed in a few tens of milliseconds, see in Table 2), and can be done earlier without any use of physical device simulator compared to the previous method. Another objective in this work was to develop a method which verifies the safety of PLC programs. With model-checker Uppaal, we verify formally for each reachable state of system, if the set of dangerous states (representing the property to verify) is not violated. We proposed also in this work to generate automatically the Uppaal models of verification for any new project, so that systems engineers will not lose time in designing it themselves.

The method of automatic verification has been presented to SNCF's systems engineers, and was judged interesting insofar as it allows to verify quickly and automatically the correctness of any PLC programs. Moreover, it has been used to verify a program newly developed by systems engineers and not tested yet during factory tests. For this we implemented the program in our tool, and we corrected all the problems detected in the new program. The obtained results was presented to systems engineers, then they were approved.

In addition to reduce time project and human error during verification, these results will facilitate validation step of electrical cabinets' wiring. In fact, systems engineers use recipe book to validate both programs and cabinets. When they encounter an instruction not satisfied in recipe book, they must analyze it and determine if it is due to programming error, or wiring error. With our method, they can

now exclude the first hypothesis during factory tests because programs are validated earlier.

Our future work will focus on the improvement of validation step of electrical cabinets' wiring. As for program validation, we will try to make it faster and automatic in order to reduce at most time validation during any automation project.

REFERENCES

- Behrmann, G., Bengtsson, J., David, A., Larsen, K.-G., Pettersson, P., Yi, W., 2002. Uppaal implementation secrets. *7th International Symposium on Formal Techniques in Real-Time and Fault Tolerant Systems*. In Springer, Verlag London, UK 2002: 3-22.
- Coupat, R., 2014. *Automatic generation of safe PLC program for PSEEL*, Phd, Reims, University of Reims Champagne-Ardenne, december 2014.
- Coupat, R., Meslay, M., Burette, M.-A., Philippot, A., Annebicque, D., Riera, B., 2014. Standardization and Safety Control Generation for SNCF Systems Engineer. *19th IFAC World Congress 2014 (IFAC WC 2014)*, Cape Town, South Africa, 2014.
- EN 50126, 2012. Applications ferroviaires - Spécification et démonstration de la fiabilité, de la disponibilité, de la maintenabilité et de la sécurité (FDMS).
- Mokadem, H.-B., Bérard, B., Gourcuff, V., De Smet, O., Roussel, J.-M., 2010. Verification of a timed multitask system with UPPAAL. *IEEE Transactions on Automation Science and Engineering, Institute of Electrical and Electronics Engineers*, 7 (4), pp.921 - 932.<10.1109/TASE.2010.2050199>.<hal- 0527736>.
- IEC 60870-4 , 2013. Telecontrol equipment and systems. Part 4: Performance requirements Ed. 1.
- IEC (International Electrotechnical Commission). IEC Standard 61131 : Programmable controllers - Part 3, 1993.
- Machado, J., Denis, B., Lesage, J.-J., Faure, J.-M., Ferreira Da Silva, J., 2006. Logic controllers dependability verification using a plant model In *Proc. 3rd IFAC Workshop on Discrete-Event System Design, (DESDes'06)*, Rydzyna (Poland), Sept. 2006, pages 37-42.