



**HAL**  
open science

# Designing the Digital Twins of Reconfigurable Manufacturing Systems: application on a smart factory

Catherine da Cunha, Olivier Cardin, Guillaume Gallot, Julien Viaud

► **To cite this version:**

Catherine da Cunha, Olivier Cardin, Guillaume Gallot, Julien Viaud. Designing the Digital Twins of Reconfigurable Manufacturing Systems: application on a smart factory. IFAC Symposium on Information Control Problems in Manufacturing INCOM, 2021, Budapest, Hungary. pp.874-879, 10.1016/j.ifacol.2021.08.103 . hal-03423497

**HAL Id: hal-03423497**

**<https://hal.science/hal-03423497v1>**

Submitted on 5 Jan 2024

**HAL** is a multi-disciplinary open access archive for the deposit and dissemination of scientific research documents, whether they are published or not. The documents may come from teaching and research institutions in France or abroad, or from public or private research centers.

L'archive ouverte pluridisciplinaire **HAL**, est destinée au dépôt et à la diffusion de documents scientifiques de niveau recherche, publiés ou non, émanant des établissements d'enseignement et de recherche français ou étrangers, des laboratoires publics ou privés.



Distributed under a Creative Commons Attribution - NonCommercial 4.0 International License

# Designing the Digital Twins of Reconfigurable Manufacturing Systems: application on a smart factory

Catherine da Cunha\*, Olivier Cardin\*\*,  
Guillaume Gallot\*\*\*, Julien Viaud\*\*\*

\*LS2N UMR CNRS 6004, Centrale Nantes, 1 rue de la Noé, 44321 Nantes, France  
(e-mail: Catherine.da-cunha@ls2n.fr)

\*\* LS2N UMR CNRS 6004, Nantes University, IUT de Nantes, 2 av. Du Pr. J. Rouxel, 44470 Carquefou, France  
(e-mail: Olivier.Cardin@ls2n.fr)

\*\*\* Capacités SAS, 2 av. Du Pr. J. Rouxel, 44470 Carquefou, France,  
(e-mail: guillaume.gallot@capacites.fr – Julien.viaud@capacites.fr)}

---

**Abstract:** The emergence of Digital Twins in manufacturing enables in-depth integration of the physical and informational worlds. Meanwhile, the concept of Reconfigurable Manufacturing Systems exhibits new opportunities and new constraints in the way the manufacturing systems are designed and managed. Among others, the notion of modularity is a prerequisite for both physical components and their informational counterparts. To provide the benefits of Digital Twin to Reconfigurable Manufacturing Systems, this paper introduces a modular design of the Digital Twin counterpart of the components. A prototype system is developed to demonstrate the modular design's benefits, with an application on a reconfigurable learning factory.

*Keywords:* Reconfigurable Manufacturing Systems, Modularity, Digital Twin, Manufacturing systems.

---

## 1. INTRODUCTION

The evolution of today's manufacturing systems is characterized by the parallel development of several key concepts meant to deeply transform the way the systems perform. Among these concepts, Reconfigurable Manufacturing Systems (RMS) and Digital Twins (DT) are expected to be complementary and magnify their respective impact.

RMS are manufacturing systems whose physical and logical structures at all levels of the system's composition can be changed quickly and inexpensively to adjust production capacities and functionalities around a family of products responding to sudden changes in the market (Capawa Fotsoh, Mebarki, Castagna, and Berruet 2020). The composition of RMS is generally based on physical modules and standard logics (cells, machines, material handling systems, storage equipment, controllers, tools, fasteners, etc.) that can be added, modified, rearranged, swapped or replaced quickly and reliably as needed to meet the changing requirements of the market requirements. The location of these modules can also be modified, at the workshop level, to achieve the configuration that best meets the production context requirements (Capawa Fotsoh, Mebarki, Castagna, Berruet, et al. 2020). A configuration is defined as a state of the system that responds to a particular context (Lameche et al. 2017). To define the configuration of the system, a set of system parameters must be defined that determine this configuration. The number of machines, of assembly lines, of loading stations, of AGVs, of operators, the positioning of

these objects in the workshop, the rules for managing the AGV fleet, are some examples of configuration parameters.

The Digital Twin (DT) was first used in aerospace and aeronautic by NASA as a diagnostic and prognostic tool to plan the maintenance and increase the safety of an aircraft throughout its lifecycle. It used sensors data and near-real-time information to feed different simulators with the needed inputs to correctly mirror the behavior of the aircraft (Shafto et al. 2010; Wang et al. 2015). Since then, its usage has been largely developed, and the expectations in manufacturing are now important. The most convincing approach deals with predictive maintenance (Vathoopan et al. 2018; Werner et al. 2019), which generally focuses on a limited perimeter (often a machine or a group of machines). One of the main challenges is to apply this concept to large manufacturing systems (Kong et al. 2020). If SCADA systems, basic component of a DT, are already well established in industry, the other part, including the models, is not yet well established. Due to a lack of genericity in the approach, the setting up of a DT is time-consuming, and it has to be re-done each time a modification in the manufacturing system occurs. When the enterprise strategy is based on rapid adaptations to market changes, methods have to be found to reduce DT's set-up time.

The adaptation between DT and RMS is therefore an important issue, and is facing a scientific deadlock that encompasses all the phases of the lifecycle of the DT, from its design to its usage in execution. This article focuses on the design phase of the DT, and presents a modular framework

for DT design, that enables quick DT reconfiguration in execution.

Next section exhibits some related works about the currently developed applications of DT to RMS. The third section introduces the framework, based on the modularity feature of the RMS. The fourth section presents the FESTO smart factory that is used in the fifth section to experiment the creation of a DT based on the framework.

## 2. RELATED WORKS

### 2.1 Reconfigurable Manufacturing Systems

Since the 19<sup>th</sup> century, mass production thrives thanks to dedicated manufacturing systems. They rely on technologies from the first and second industrial revolutions (mechanization and electrification).

From the 1990s, the evolution of markets and the increased competition between firms boosted portfolio evolution and customization. Those new production strategies required production systems that evolve and adapt rapidly.

Reconfigurable Manufacturing Systems (RMS) answer these needs to rapidly respond to abrupt changes and with cost control, building on the enabling technologies from the third and fourth industrial revolution (robotization and digitalization). This dynamic and evolving architecture combines the advantages of dedicated and flexible systems. RMS enables facing unpredictable, high-frequency market changes driven by market competition (Koren et al. 1999).

RMS deeply rely on their capacity to analyze current performances of the system and identify room for improvements. This monitoring and managing aspect can be supported by digital twins.

### 2.2 Digital Twin for RMS

The issues currently facing the academic communities towards the Digital Twin concept applied to manufacturing systems are multiple. Among them, the design of Digital Twin in itself is a complex matter. Numerous generic architectures were proposed, with various focuses. For example, the architecture proposed by (Răileanu et al. 2020) is especially focused on the DT's expected functionalities. It is composed of 4 layers (Fig. 1), corresponding to the data collection, data transmission, data aggregation, and decision making. The reconfiguration process deals with the third and fourth layers, where the DT models need to be reconfigured themselves in parallel with the actual reconfiguration process.

The architecture introduced by (Redelinghuys et al. 2019) and denoted SLADTA (Fig. 2) is centered on the communication technologies enabling the connectivity and data transmission between the different layers of the architecture. It uses industrial OPC gateways to synchronize the data with the physical twins and interconnect those gateways to model the aggregation of the system. This architecture is centered on the DT's online phase, but the

whole lifecycle of the DT is not dealt with, which is specifically relevant in the context of RMS.

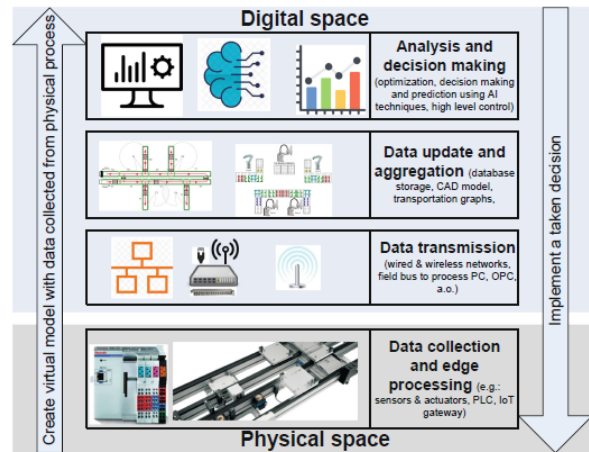

Fig. 1. Digital Twin architecture (Răileanu et al. 2020)

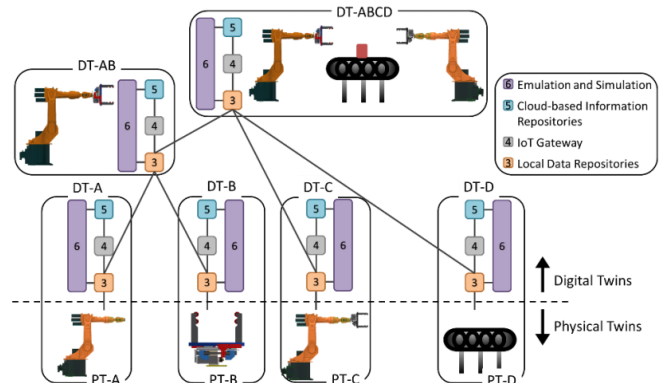

Fig. 2. Application of SLADTA general architecture on a manufacturing scenario (Redelinghuys et al. 2019)

The framework introduced in (Zhang et al. 2019) and presented in Fig. 3 is focused on the system's lifecycle and introduces the notion of reconfigurability. The five pillars of this framework are: the rules, the behaviors, the capabilities, the physics, and the geometry. Each element of the DT is considered as a unit with autonomous functions; it is equipped with each of the five models corresponding to the respective pillars. In this way, the structure of the DT inherits the modular aspect of the elements constituting the RMS.

Examining all these examples, a common feature of the considered RMS, that is also present in most of the RMS in literature, can be exhibited: the information is carried from one module to another of the RMS by the product (or its transporter), leading to consider each configuration of the RMS as a product-driven system (Trentesaux and Thomas 2012). This work intends to introduce a behavior model able to take this specificity into account at the data aggregation layer level (Răileanu et al. 2020).

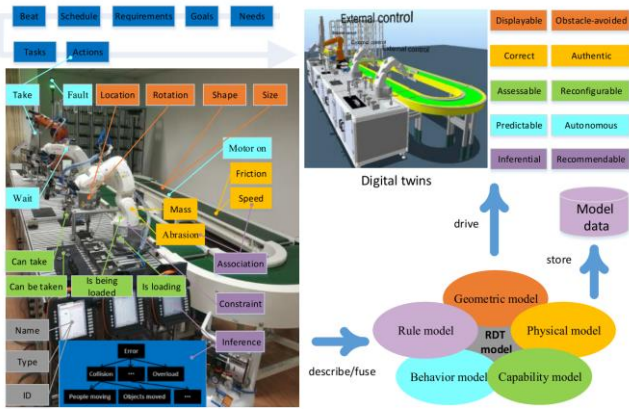

Fig. 3. Five-dimensional RDT model (Zhang et al. 2019)

### 3. DIGITAL TWIN MODULAR FRAMEWORK

The design of an RMS-adapted DT needs to be decomposed into three main steps. First, in coherence with the physical modules, the DT modules need to be defined to autonomously aggregate the data coming from the system (i.e. in any configuration of the final DT). Then, the products going through the modules need to be defined. Finally, the DT is meant to be designed by associating the modules. This section introduces some insights about those three steps in the following.

#### 3.1 Definition of the modules

A module of RMS is here considered as designed with the same perimeter as a transformation station. The different transformations are either on the product itself (classical workstations), on the recipe of the product (e.g. control stations implying reworking), on the spatial behavior (e.g. divergences), or a composition of those transformations (e.g. disassembly stations composed by a transformation of the product followed by a spatial transformation). Each module is therefore designed as a succession of three elements:

1. One or several feeding areas, characterized by an entrance and a length (length can be equal to zero if the area does not exist in the physical world);
2. A transformation station, characterized by the parameters of the transformation;
3. One or several output areas, characterized by a length (that can be null) and an output.

Each module is equipped with the five models, as defined by (Zhang et al. 2019):

1. The geometric model defines the length of the areas and the location of the station;
2. The physical model defines the technology used for transfers (e.g. conveyors and their associated speed);

3. The capability model defines the transformation performed by the station;
4. The rule model contains the rules of routing inside the modules;
5. Finally, the behavior model contains the set of data handled by the module and the real-time state of the module.

The way these different models are designed is out of the scope of this work. The remainder of this paper will focus on the definition of the design parameters.

#### 3.2 Definition of the products

The product definition has to be independent of the chosen configuration of the RMS. In that sense, a given configuration of the RMS is in this work only seen as a Product-Driven System. In a Product-Driven System the products are transferred from one transformation station to another and are carrying their information.

Here products are considered as tokens that evolve in the modules and from one module to another (through their connections). The tokens are characterized by:

- The identification of the related product;
- The information carried by the product (typically related to its recipe (BOM and routing), traceability data, or performance indicators);
- The product's location, expressed as the identification of the module and the position inside the module.

#### 3.3 Connection of the modules

Once the modules are created, the last step is to connect them to fit the expected configuration. The definition of the configurations of DT needs to be recursive to consider the possibility of combining single modules into higher-level modules.

As the modules are defined, the interfaces are only depicted by the inputs and outputs of the transfer areas, and the product in itself handles the interoperability issues.

## 4. CASE STUDY: FESTO LEARNING FACTORY

### 4.1 LS2N Smart Factory

LS2N (Laboratoire des Sciences du Numérique de Nantes) has acquired a smart factory. It is composed of Festo CP Factory elements. The platform is an assembly line that meets the 6 RMS characteristics (as listed by (Koren et al. 2018)).

1. Scalability is possible by the simple addition of new elements. The present platform possesses 12 elements (linear production stations, branch



production stations, automatic storage systems, robotic assembly cells).

2. Identification of problems (Diagnosability) is possible through the control console (of each element) and from the global MES
3. Flexibility within a product family (Customization) is possible. The platform permits to assemble mobile phone cases of different shapes and colors (Puviyarasu and da Cunha 2021).
4. Adaptation to production requirements (Convertibility) is enabled by the diversity of operating cells that can be equipped on each production station.
5. Integrability of the system is possible thanks to the physical connection of the elements (system cable) and their informational connection (shared language)
6. The modularity aspect is enabled by the shared dimensions of elements and the transport systems (conveyors and AGV).

#### 4.2 Case study line: As-Is configuration

This paper focuses on the DT of the “Inspection and finishing steps” modules. This line is composed of two linear stations and one branch station. They are equipped with operating cells, and conveyors permit the movement of products, see figure 4.

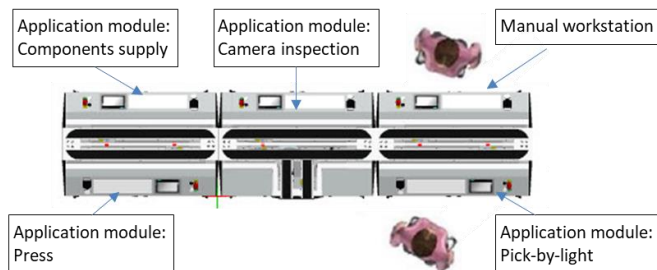

Fig. 4. Considered stations

Three cells are automated:

- Camera inspection: automated visual comparison of the actual product and customer order,
- Positioning of the top cover of the product, from the components supply module,
- Pressing of the top cover.

Two cells (manual workplace and pick by light) are manual; they enable rectifications on identified non-conforming products.

We chose the physical station to aggregate the digital twin. Each cell can be represented through its own PLC, and each conveyor considered as two sub-conveyors separated by the operating cell. Figure 5 shows the as-is configuration using this filter.

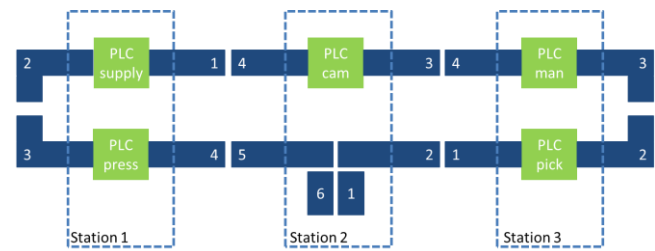

Fig. 5. As-Is configuration

The as-is configuration of the “Inspection and finishing steps” line is not optimal. A non-conforming product will be detected by the camera and convey to the manual cells for the needed rectification, and only then completed by the top cover before exiting the line. 2 complete crossings of the line will then be necessary.

The path of this product will then be: Station 2 (entry), station 3 (only crossing), station 2 (detection), station 1 (only crossing), station 2(only crossing), station 3 (rectification), station 2 (detection), station 1 (positioning and press), station 2 (exiting) which correspond to 12 meters.

The layout could be modified to be more efficient

#### 4.3 Case study line: To-Be configuration

The swap between stations 2 and 3 will decrease a faulty product’s journey from 12 to 6 meters. This is a major productivity gain. The to-be configuration is represented in figure 6.

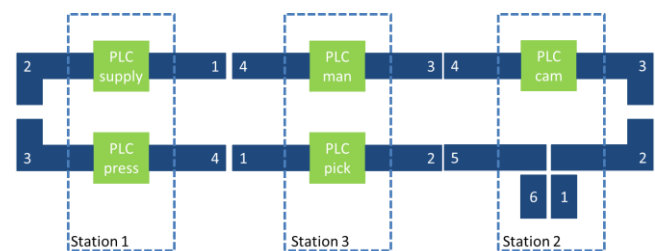

Fig. 6. To-Be configuration

On a RMS, such a change in layout is easy, yet the challenge is to transcribe these physical changes into the digital representation.

## 5. EXPERIMENTATIONS

### 5.1 General parameters

The static model of DT encompasses the definition of the modules (cf. section 3.1):

- CAD modeling of production elements (Fig. 7), operating cells, products (with different WIP status)
- Connection with OPC/UA: this has to be done for stations equipped with operating cells and conveyors. Fig. 8 stresses data to be read/written in the OPC server of the “Press” operation cell.

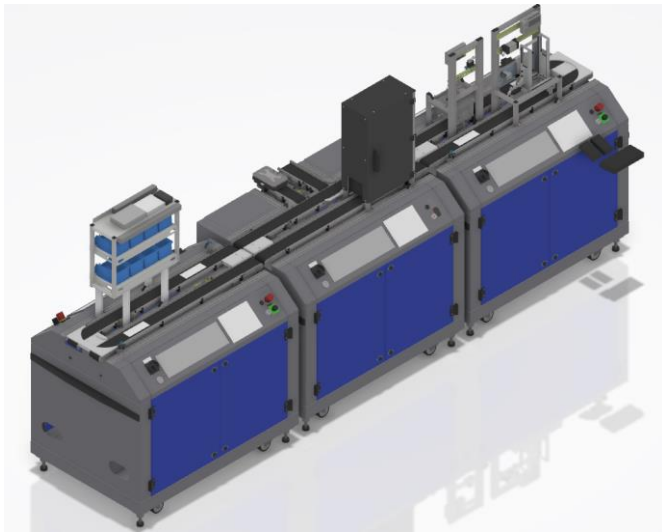

Fig. 7. CAD model (using 3Dx)

ResourceId	Nom Topic	Value	Link
rs-3=cbRfcData "ID1"IC	Rfid		→
rs-3=WW1_BG61	Capteur4		→
rs-3=WW1_BG50	Stopper		→
rs-3=cbRfidData "ID1"IC	Rfid		→
rs-3=WW1_BG21	Capteur4		→
rs-3=WW1_BG20	Stopper		→
rs-3=WW1_BG66	ExtremiteGauche		→
rs-3=WW1_BG67	ExtremiteDroite		→
rs-3=WW1_OA1A2	MoveLeft		→
rs-3=WW1_OA1A1	MoveRight		→
rs-3=WW1_OA1A3	MoveSlow		→
rs-3=WW1_BG26	ExtremiteGauche		→
rs-3=WW1_BG27	ExtremiteDroite		→

Fig. 8. OPC for the Press element

In our implementation, the product’s definition (Cf. section 3.2) is done using a token. Each token has a unique identification (linked to its working order). It is modeled as a Json text file, Fig. 9.

```
{
  "TwinName": "",
  "ProductId": "",
  "UnitId": "",
  "UnitPosition": 0
}
```

Fig. 9 Product-token

### 5.2 As-Is configuration parameters

With the selected approach, a DT configuration is composed of:

- The list of present DT elements,
- Line topology (connections between DT elements)

The As-Is configuration can be modeled with XML files, one for each twin station. In our As-Is configuration, there are 5 operating cells and 14 conveyors elements. Fig. 10 describes the DT press and its conveyors.

```
TwinStation1
<DataGroup Name="PlcPress" />
</DataGroup>
<Conveyor Id="3" TwinInputName="3"/>
<Conveyor Id="4" TwinOutputName="4"/>
<TopologyGroup>
<Data Name = "2" Target = "TwinStation1" TargetInput = "3"/>
<Data Name = "4" Target = "TwinStation2" TargetInput = "5"/>
</TopologyGroup>
```

Fig. 10. DT press As-Is configuration

### 5.3 To-Be configuration parameters

If the DT modeling is done according to the reconfigurability principle, setting a new configuration is a simple task. In our case, the operating cells are kept; only the layout is changed. This means that only the topology needs to be modified in the XML files. Below is the to-be configuration of DTpress, Fig. 11.

```
TwinStation1
<DataGroup Name="PlcPress" />
</DataGroup>
<Conveyor Id="3" TwinInputName="3"/>
<Conveyor Id="4" TwinOutputName="4"/>
<TopologyGroup>
<Data Name = "2" Target = "TwinStation1" TargetInput = "3"/>
<Data Name = "4" Target = "TwinStation3" TargetInput = "1"/>
</TopologyGroup>
```

Fig. 11. DT press To-Be configuration

The xml files enable to set rapidly the design parameters of the new DT. Once the new DT is configured, data can be coherently collected in order to construct the associated behavior model.

## 6. CONCLUSIONS

Digital twins can be an important asset to manage production systems. Modification of the real production systems should

therefore be translated rapidly into the DT. Using Reconfigurable manufacturing systems in the workshops implies frequent modifications of the systems. Therefore, the coupling between RMS and DT implies an initial design of the DT that enables a rapid reconfiguration of the DT together with the RMS. This article presents a design framework based on modularity and the coupling mechanisms of the different modules.

Future works will focus on the automation of this reconfiguration, using Product-Driven System characteristics, based on the configuration patterns defined in the Manufacturing Execution Systems' database of the RMS. Another lead is to extend the definition of the modules and configurations of RMS (Capawa Fotsoh, Mebarki, Castagna, Berruet, et al. 2020) to integrate the DT modules directly in the RMS modules definition, the same way the manufacturing control is.

#### REFERENCES

- Capawa Fotsoh, E., Mebarki, N., Castagna, P., & Berruet, P. (2020). A Classification for Reconfigurable Manufacturing Systems. In L. Benyoucef (Ed.), *Reconfigurable Manufacturing Systems: From Design to Implementation* (pp. 11–28). Cham: Springer International Publishing. [https://doi.org/10.1007/978-3-030-28782-5\\_2](https://doi.org/10.1007/978-3-030-28782-5_2)
- Capawa Fotsoh, E., Mebarki, N., Castagna, P., Berruet, P., & Gamboa, F. (2020). Towards a Reference Model for Configuration of Reconfigurable Manufacturing System (RMS). In B. Lalic, V. Majstorovic, U. Marjanovic, G. von Cieminski, & D. Romero (Eds.), *Advances in Production Management Systems. The Path to Digital Transformation and Innovation of Production Management Systems* (pp. 391–398). Cham: Springer International Publishing. [https://doi.org/10.1007/978-3-030-57993-7\\_44](https://doi.org/10.1007/978-3-030-57993-7_44)
- Kong, T., Hu, T., Zhou, T., & Ye, Y. (2020). Data Construction Method for the Applications of Workshop Digital Twin System. *Journal of Manufacturing Systems*. <https://doi.org/10.1016/j.jmsy.2020.02.003>
- Koren, Y., Gu, X., & Guo, W. (2018). Reconfigurable manufacturing systems: Principles, design, and future trends. *Frontiers of Mechanical Engineering*, 13(2), 121–136. <https://doi.org/10.1007/s11465-018-0483-0>
- Koren, Y., Heisel, U., Jovane, F., Moriwaki, T., Pritschow, G., Ulsoy, G., & Van Brussel, H. (1999). Reconfigurable Manufacturing Systems. *CIRP Annals*, 48(2), 527–540. [https://doi.org/10.1016/S0007-8506\(07\)63232-6](https://doi.org/10.1016/S0007-8506(07)63232-6)
- Lameche, K., Najid, N. M., Castagna, P., & Kouiss, K. (2017). Modularity in the design of reconfigurable manufacturing systems. *IFAC-PapersOnLine*, 50(1), 3511–3516. <https://doi.org/10.1016/j.ifacol.2017.08.939>
- Puviyarasu, S. A., & da Cunha, C. (2021). Smart Factory: From concepts to operational sustainable outcomes using test-beds. *LogForum*, 17(1), 51–67.
- Răileanu, S., Borangiu, T., Ivănescu, N., Morariu, O., & Anton, F. (2020). Integrating the Digital Twin of a Shop Floor Conveyor in the Manufacturing Control System. In T. Borangiu, D. Trentesaux, P. Leitão, A. Giret Boggino, & V. Botti (Eds.), *Service Oriented, Holonic and Multi-agent Manufacturing Systems for Industry of the Future* (pp. 134–145). Cham: Springer International Publishing.
- Redelinghuys, A. J. H., Basson, A. H., & Kruger, K. (2019). A six-layer architecture for the digital twin: a manufacturing case study implementation. *Journal of Intelligent Manufacturing*. <https://doi.org/10.1007/s10845-019-01516-6>
- Shafto, Mike, Mike Conroy, Rich Doyle, Ed Glaessgen, Chris Kemp, et al. (2010). DRAFT Modeling, Simulation, Information Technology & Processing Roadmap. Technology Area 11. *mafiadoc.com*. [https://mafiadoc.com/nasa-modeling-simulation-information-technology-processing-\\_597ba4671723ddb18e74c884.html](https://mafiadoc.com/nasa-modeling-simulation-information-technology-processing-_597ba4671723ddb18e74c884.html). Accessed 11 March 2019
- Trentesaux, D., & Thomas, A. (2012). Product-Driven Control: A State of the Art and Future Trends. In T. Borangiu (Ed.), *INCOM 2012 Proceedings* (pp. 716–721). <https://doi.org/10.3182/20120523-3-RO-2023.00081>
- Vathoopan, M., Johny, M., Zoitl, A., & Knoll, A. (2018). Modular Fault Ascription and Corrective Maintenance Using a Digital Twin. *IFAC-PapersOnLine*, 51(11), 1041–1046. <https://doi.org/10.1016/j.ifacol.2018.08.470>
- Wang, Haynes, Huang, Dong, & Atluri. (2015). The Use of High-Performance Fatigue Mechanics and the Extended Kalman/Particle Filters, for Diagnostics and Prognostics of Aircraft Structures. *ResearchGate*. <http://dx.doi.org/10.1201/b18009-2>
- Werner, A., Zimmermann, N., & Lentens, J. (2019). Approach for a Holistic Predictive Maintenance Strategy by Incorporating a Digital Twin. *Procedia Manufacturing*, 39, 1743–1751. <https://doi.org/10.1016/j.promfg.2020.01.265>
- Zhang, C., Xu, W., Liu, J., Liu, Z., Zhou, Z., & Pham, D. T. (2019). A Reconfigurable Modeling Approach for Digital Twin-based Manufacturing System. *Procedia CIRP*, 83, 118–125. <https://doi.org/10.1016/j.procir.2019.03.141>