



HAL
open science

Mode family identification of a blisk by tip timing measurements

Vsevolod Kharyton, Claude Gibert, Laurent Blanc, Fabrice Thouverez

► **To cite this version:**

Vsevolod Kharyton, Claude Gibert, Laurent Blanc, Fabrice Thouverez. Mode family identification of a blisk by tip timing measurements. CFM 2011 - 20ème Congrès Français de Mécanique, Aug 2011, Besançon, France. hal-03421513

HAL Id: hal-03421513

<https://hal.science/hal-03421513>

Submitted on 9 Nov 2021

HAL is a multi-disciplinary open access archive for the deposit and dissemination of scientific research documents, whether they are published or not. The documents may come from teaching and research institutions in France or abroad, or from public or private research centers.

L'archive ouverte pluridisciplinaire **HAL**, est destinée au dépôt et à la diffusion de documents scientifiques de niveau recherche, publiés ou non, émanant des établissements d'enseignement et de recherche français ou étrangers, des laboratoires publics ou privés.

Mode family identification of a blisk by tip timing measurements

Vsevolod Kharyton^a, Claude Gibert^a, Laurent Blanc^a, Fabrice Thouverez^a

a. Laboratory of Tribology and System Dynamics UMR5513, Ecole Centrale de Lyon

Abstract :

The study consists in tip timing measurements to identify the family (flexural, torsion, etc) of some resonant modes of a rotating blisk. This can be performed by placing different probes over blade tip profile and, thus, relating its deformed state to a mode family. The identification is performed for modes generating either standing or travelling wave response. It is followed by amplitude and phase distribution calculation of each blade for identification of nodal diameters number.

Résumé :

Cette étude concerne l'utilisation de mesures en tip timing afin d'identifier les familles des modes (flexion, torsion, etc.) dans une réponse forcée d'un blisk en rotation. Pour ceci, plusieurs capteurs sont placés le long des têtes d'aubes dont les déformées mesurées sont alors associées aux familles de modes. Des modes de nature fixe ou tournante ont été identifiés. Les distributions des amplitudes et des phases des extrémités d'aubes ont été calculées pour l'identification du nombre des diamètres nodaux.

Key words : tip timing method, mode identification, blisk, forced response, travelling wave

1 Introduction

The main advantage of the blade tip-timing (BTT) method is that it makes full and contactless monitoring of blade vibration possible even when using only one sensor, contrary to strain gauges. Monitoring the health of aviation engines requires relevant information about blade vibrations [1]. Thus the BTT method can be used to develop a relatively non intrusive and on-line system for monitoring the dynamic performance of the blade in operation. Different methodologies are used to provide tip-timing measurements under either synchronous or asynchronous vibration, emphasizing the undersampled nature of such measurements [2]. As reported in [3], such data processing methods show dependency between the number of probes and the frequency content of the vibration signal. Single-probe measurements are described in [4], stressing the angular position of the probe and its influence on errors of maximum amplitude reconstruction. Questions concerning the correlation between vibration amplitude measured by probe and blade tip displacement require consideration [4]. A recent study [5] described a methodology for performing multi-probe measurements for mode shape reconstruction and the possible identification of cracks in blades. A minimum of two probes are required to perform this reconstruction for each measurement. Most of the studies mentioned assume synchronous vibration and constant rotation speed during one measurement (rotation period).

The study will be concentrated around the tip timing measurements in order to identify a mode belonging to a certain family: first flexural (1F), first torsion (1T) and second flexural (2F). The identification was performed placing different probes over blade tip profile and, thus, relating its deformed state with a mode family. This can be useful when correlating measured modes with their numerical counterparts, especially in a region where several modes belonging to different families are closed.

2 Tip timing data processing for mode family identification

The excitation on the test rig used in the study is sinusoidal, of known frequency and asynchronous with regard to the rotation speed. Thus, greater flexibility in terms of operation of the blisk in vibratory state is possible in this way, it allows calculation of vibration amplitude directly from single probe data. Consequently, data processing approaches have to be developed and applied to experimental tip-timing measurements.

Blade tip response has l data points at every rotation. A tip response is assumed to be sinusoidal and mono-harmonic, hence it can be expressed as follows [5]:

$$a_p^j = A^j \sin(\omega t_p^j + \psi^j), j=1 \dots n_r, p=1 \dots l, \tag{1}$$

where ω is the frequency of vibration, A^j is the maximum amplitude of the j -th blade tip and ψ^j its phase, t_p^j is the time of arrival of the j -th blade tip at the p -th probe, n_r is the number of blades (36 in our case), l is the number of probes. The parameters of Eq.1 are identified using least-squares method over selected time interval of undersampled tip timing data.

The detailed description of the test rig used here is given in [6]. The system mainly consists of one shaft driven inside a vacuum chamber by an electric motor at a prescribed rotation speed. The test piece investigated was the 36 bladed blisk of a high-pressure compressor stage mounted at end of the shaft (FIG. 1a). A particular arrangement of piezoactuators installed on the disk is able to generate either standing or travelling wave excitations. Regarding configuration of tip timing it consists of four probes installed by pairs over leading and trailing edges of the blades tips (FIG. 1b).

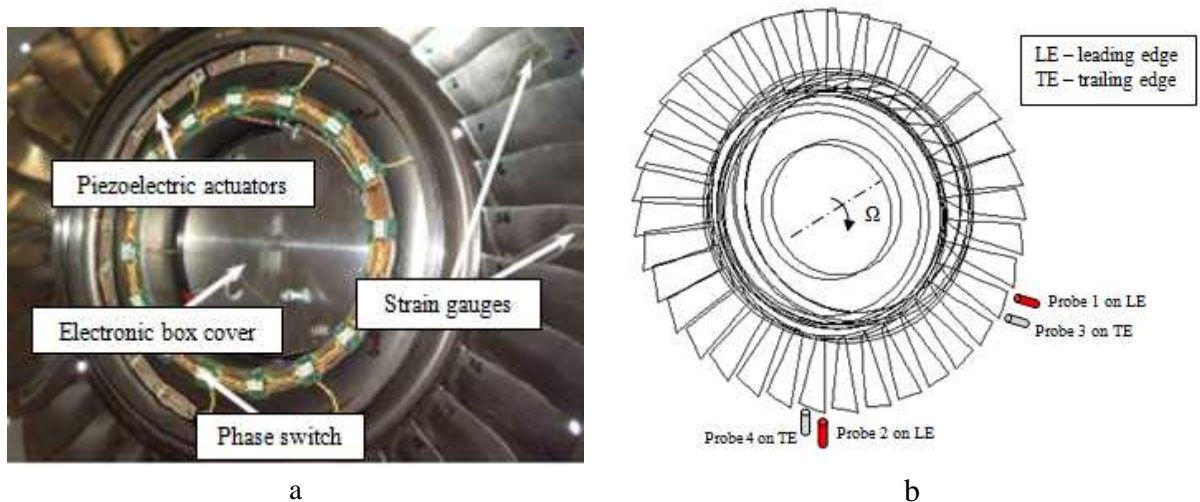

FIG. 1 – Experimental configuration: a – instrumented blisk, b – tip timing system configuration

All measurements were performed at constant rotation speed $\Omega=2072$ rpm (+/- 0.2 rpm). In order to be able to demonstrate the identification of a mode family, an excited mode should be located in the domain of weak blades-to-disk coupling (FIG. 2), where blade deformation is more typical for the family of interest.

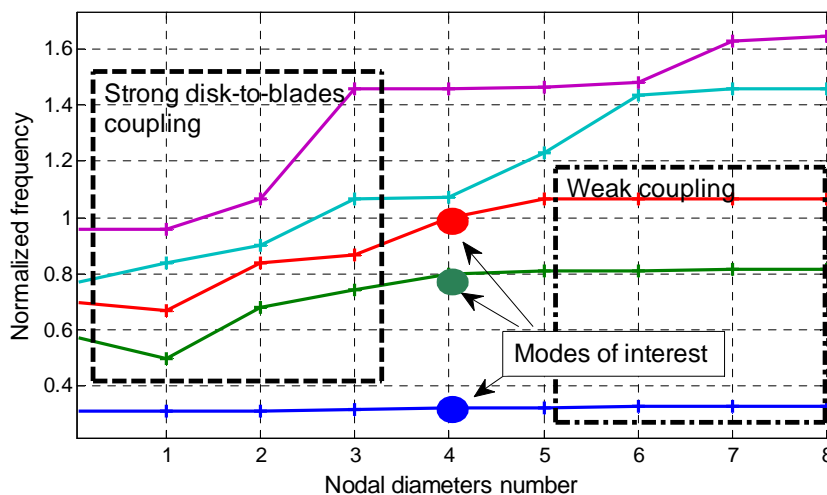

FIG. 2 – Frequency vs. number of nodal diameters diagram at rest

In the case of cyclically symmetric structures the modes are characterized by their nodal diameters number. Due to the extension of domain of blade-to-disk coupling with mode family order (in frequency), modes with high nodal diameters are preferable to be investigated as they are less effected by the disk participation. At the same time, presence of manufacturing inequalities known as mistuning vanishes the notion of nodal

diameters for such modes. Especially it concerns the modes in the domain of weak blades-to-disk coupling where mistuning influence is more significant [7].

Shown in FIG. 1b, the configuration allowed measurement of blade tip amplitude separately on leading and trailing edges of blades tips. Thus a mode belonging to a certain family can be identified comparing dependency between measured amplitudes at both edges and deformed shapes of modes of interest obtained by finite elements model (FIG. 3).

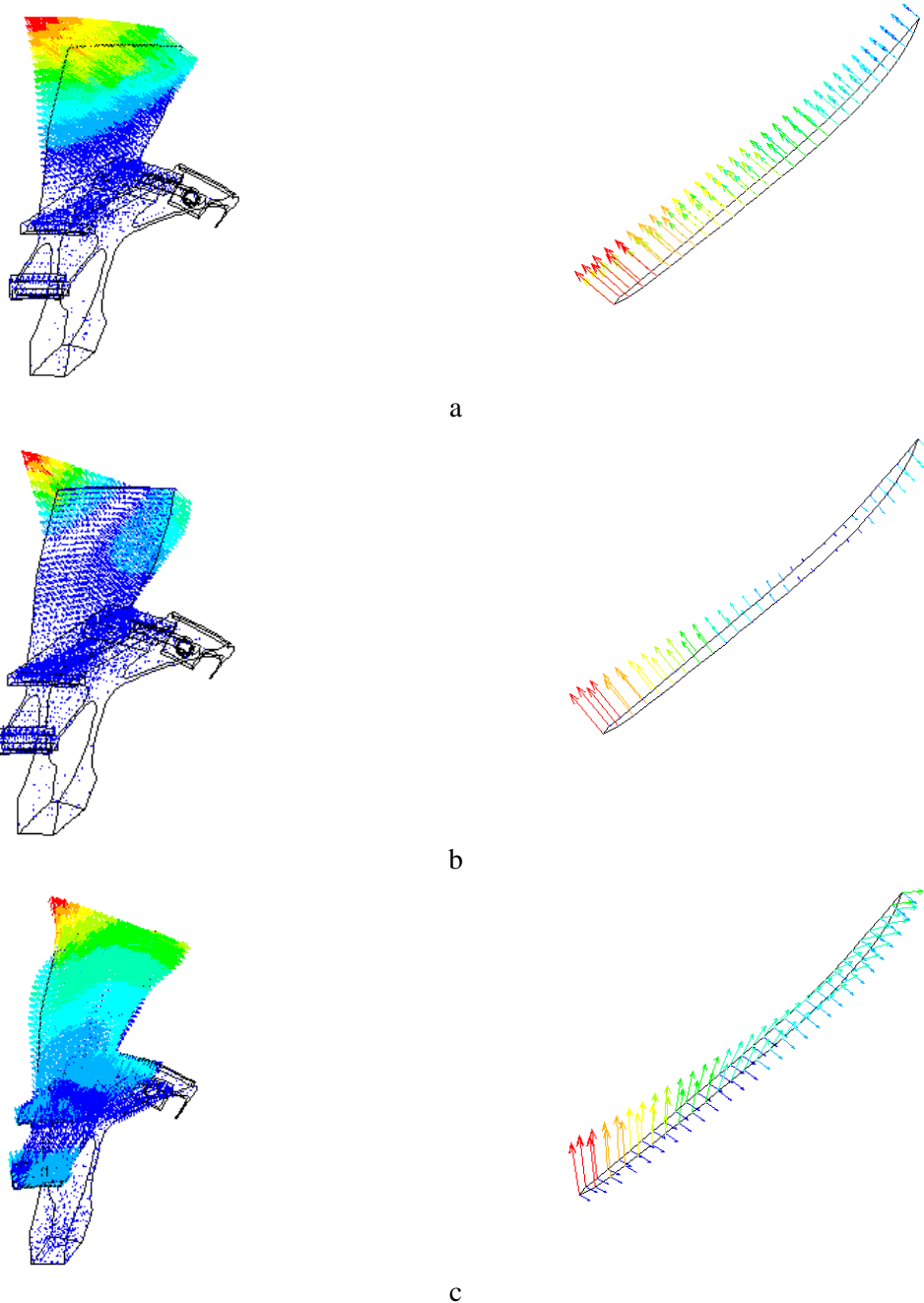

FIG. 3 – Computed mode shapes of different families:
a – first family (1F), b – second family (1T), c – third family (2F)

Computed mode shapes correspond to modes of interest shown in FIG. 2. They are the modes of four nodal diameters located in transition zone between domains of strong and weak blades-to-disk coupling. Such a choice can be explained by the impossibility to identify modes with high nodal diameters numbers in the domain of weak coupling. Although, the method could have been applied to this case for mode family identification only. Also, for the reason of compatibility of results it is preferable to measure the modes of the same nodal diameters number as the excitation pattern with four nodal diameter hasn't been to be change for the different modes studied.

3. Results of tip timing measurements

In this section results of tip timing measurements are presented with the scope to derive a mode family notion from comparison of leading edge and trailing edge tip amplitudes.

3.1 Case study – first family

Here the identification of the first family of modes associated with the first flexural mode of blades is performed. Using tip timing data the reconstruction of distribution of blades tips amplitudes (FIG. 4) was calculated using Eq. (1). More information on it can be found in [1]. It is seen from the FIG. that mode is a standing one of four nodal diameters with higher amplitudes on the leading edge that is in line with simulation results from FIG. 3a. The stationary character of the mode is also observed from FIG. 5 where relative phase (w.r.t to blade 1) distribution of blades tips is shown.

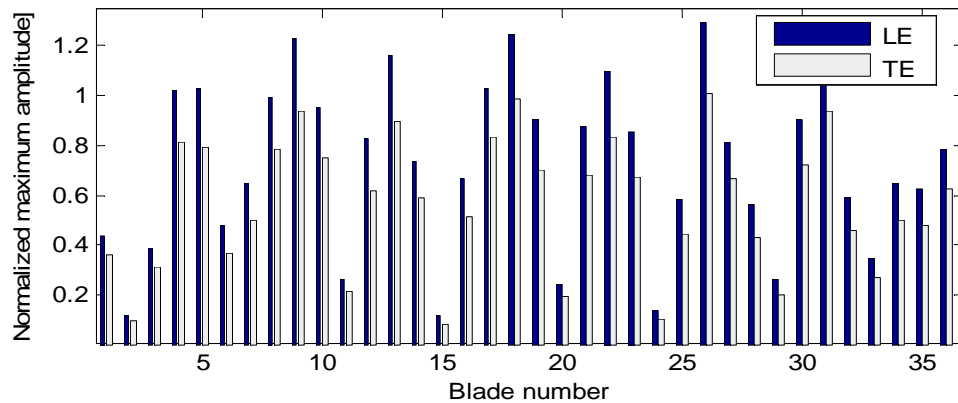

FIG. 4 – Blades tips amplitudes distribution (first family of modes)

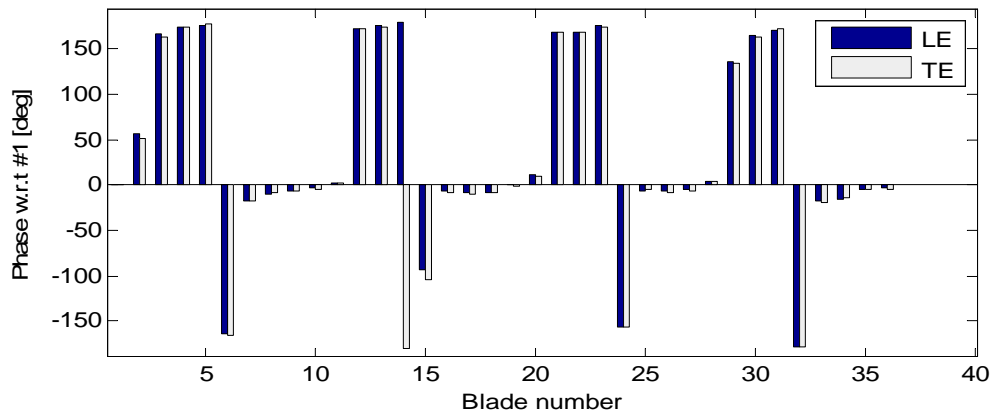

FIG. 5 – Relative phase distribution of blades tips (first family of modes)

Note that, as shown in ref [1] a calibration of tip timing measurement should be performed in order to obtain true tip displacements from BTT data. Also it should be stressed out that numerical modes shapes are compared with the forced response measured closed to resonances. Although, the correlation at this stage seems to be good.

3.2 Case study – second family

The second family of modes is described by torsion movement of blades. Blade tip displacements are characterized by very important difference between leading and trailing edges (FIG. 3a) in term of amplitude. Looking on relative phases between blades, measurement results show that the mode nature could be considered as a travelling wave one of four nodal diameters (FIG. 6). Analyzing relative phase distribution shown in FIG. 7 it is possible to observe some signs of mode's rotation nature.

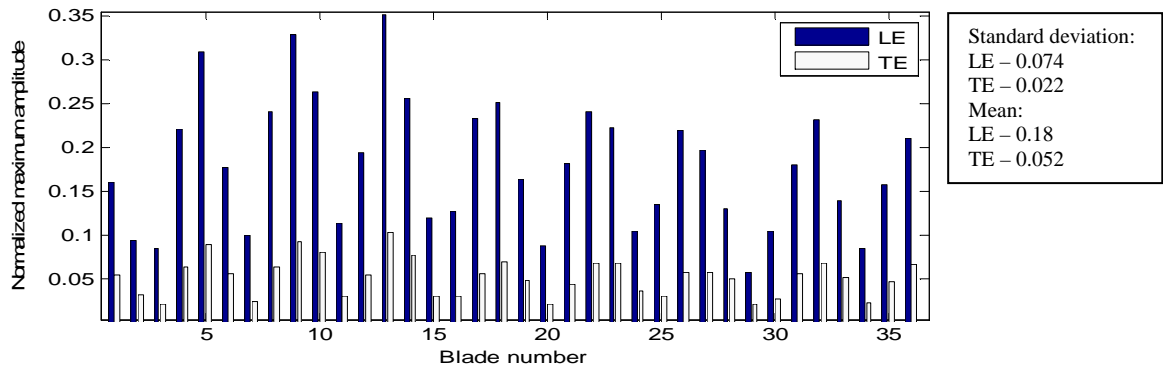

FIG. 6 – Blades tips amplitudes distribution (second family of modes)

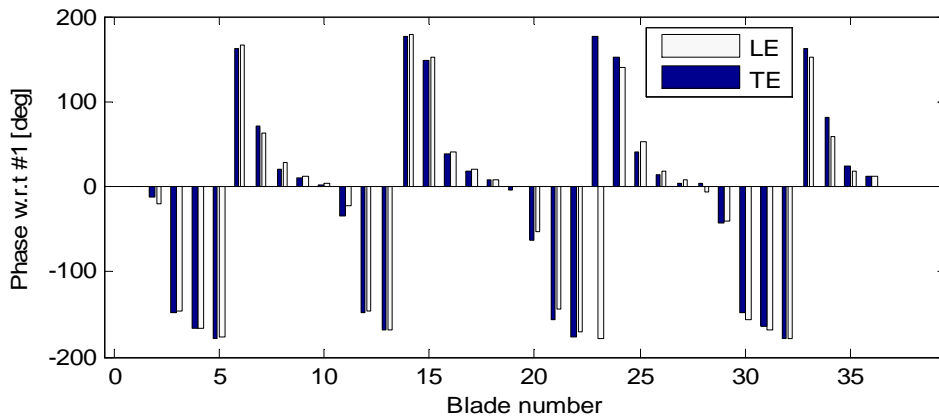

FIG. 7 – Relative phase distribution of blades tips (second family of modes)

In [6] the mode of the same family, but of two nodal diameters was studied and it was shown to be also effected by Coriolis effect. It was also shown that modes located in the zone between domains of strong and weak blades-to-disk coupling could be affected by Coriolis effect forcing a mode to rotate. It is worth to remind that the excitation in this study is the standing one with forcing frequency close to the mode resonance and it does not result in the mode rotation.

3.3 Case study – third family

The rotating nature of the mode is reflected by a quasi uniform distribution of blades amplitudes. The non-uniformity of amplitudes obtained from tip timing measurements (FIG. 8) is caused by participation of standing wave response at the frequency of interest, due to the relatively low rate of mode split for the rotation speed set, and possibly by the fact that the excitation frequency is not exactly the resonance one. Note, that the phase pattern characterizing a four nodal diameters travelling wave with 40° phase difference between two neighboring blades seems to be more noticeable on the trailing edge (FIG. 9).

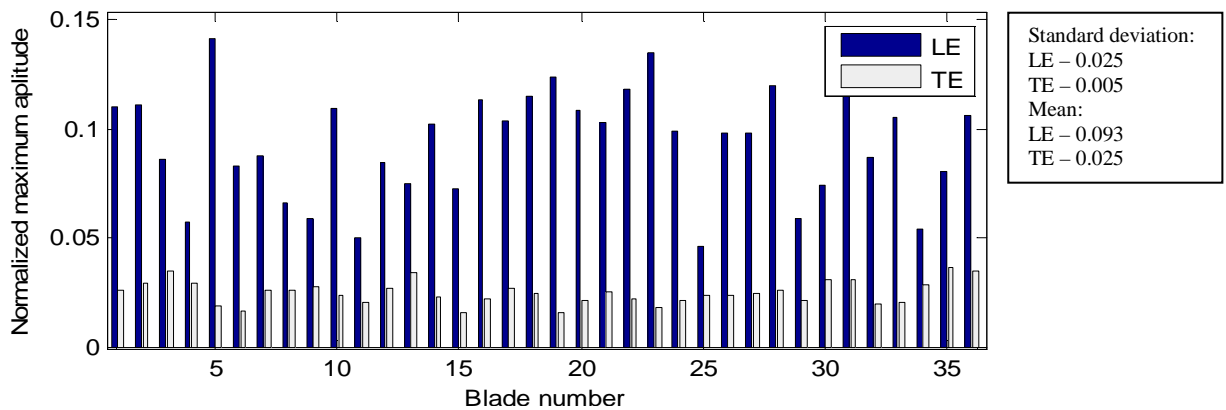

FIG. 8 – Blades tips amplitudes distribution (third family of modes)

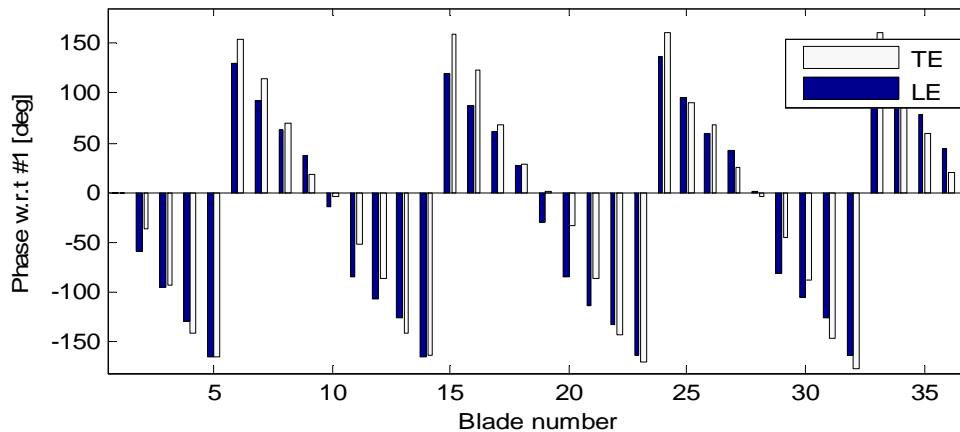

FIG. 9 – Relative phase distribution of blades tips (third family of modes)

It is noteworthy that the summation of the two travelling waves (backward and forward) contains a stationary wave part dependant on the relative amplitudes of the two waves. Mode's rotating nature is easily derived from relative phase distribution.

Comparing results of third and second modes families responses, it is possible to state that the rotating nature is clearer in the case of third family. It could be explained by the higher split rate due to Coriolis effect that corresponds to higher coupling with the disk (FIG. 2).

Conclusions

The main issue of the study is the use of single-probe measurements to identify a mode belonging to a certain family. This was performed by placing the probes over the blade tip profile and, thus linking its deformed state with a mode family.

Additionally it was shown the identification of the rotating nature of two modes of interest influenced by Coriolis effect. It confirms stated in the previous studies the necessity to take into account this effect, especially when modes located in the domain of strong blades-to-disk coupling are under consideration.

References

- [1] Zielinski, M., Ziller, G., Noncontact vibration measurements on compressor rotor blades. *Measurements Science and Technology*, 11, 847–856, 2000.
- [2] Salhi, B. et al. Modal parameter identification of mistuned bladed disks using tip timing data. *Journal of Sound and Vibration*, 314 (3-5), 885-906, 2008.
- [3] Gallego-Garrido, J., Dimitriadis, G., Wright, J. R. A class of methods for the analysis of blade tip timing data from bladed assemblies undergoing simultaneous resonances – Part I: Theoretical Development. *International Journal of Rotating Machinery*, 2007, p.11, 2007.
- [4] Heath, S., Imregun, M., An improved single-parameter tip-timing method for turbomachinery blade vibration measurements using optical laser probes”, *International Journal of Mechanical*, 38 (10), 1047–1058, 1996.
- [5] Kharyton V., Laine J.-P., Thouverez F., Kucher O. Simulation of tip-timing measurements of a cracked bladed disk forced response. *Proceedings of ASME conference “Turboexpo 2010”, 14-18 June 2010, Glasgow, UK*
- [6] Gibert C., Kharyton V., Thouverez F., Jean P. On forced response of a rotating integrally bladed disk: predictions and experience. *Proceedings of ASME conference “Turboexpo 2010”, 14-18 June 2010, Glasgow, UK*
- [7] Judge, J., Pierre, C., Mehmed, O., Experimental investigation of mode localisation and forced response amplitude magnification for a mistuned bladed disk. *Transaction of ASME*, 123, 940–950, 2001.
- [8] Gibert C., Kharyton V., Thouverez F., Jean P. Elements of dynamic characterization of a bladed disk by using the tip-timing method under vacuum conditions. *Proceedings of ASME conference “Turboexpo 2011”, 6-10 June 2011, Vancouver, Canada*