



**HAL**  
open science

## Experimental study on the void fraction during two-phase flow of R1234yf in smooth horizontal tubes

Juan J. Garcia Pabon, Leandro Pereira, Gleberon Humia, Ali Khosravi, Rémi Revellin, Jocelyn Bonjour, Luiz Machado

### ► To cite this version:

Juan J. Garcia Pabon, Leandro Pereira, Gleberon Humia, Ali Khosravi, Rémi Revellin, et al.. Experimental study on the void fraction during two-phase flow of R1234yf in smooth horizontal tubes. International Journal of Refrigeration, 2019, 104, pp.103-112. 10.1016/j.ijrefrig.2019.05.007 . hal-03420450

**HAL Id: hal-03420450**

**<https://hal.science/hal-03420450v1>**

Submitted on 20 Feb 2024

**HAL** is a multi-disciplinary open access archive for the deposit and dissemination of scientific research documents, whether they are published or not. The documents may come from teaching and research institutions in France or abroad, or from public or private research centers.

L'archive ouverte pluridisciplinaire **HAL**, est destinée au dépôt et à la diffusion de documents scientifiques de niveau recherche, publiés ou non, émanant des établissements d'enseignement et de recherche français ou étrangers, des laboratoires publics ou privés.

---

This is an electronic reprint of the original article.  
This reprint may differ from the original in pagination and typographic detail.

Garcia Pabon, Juan Jose; Pereira, Leandro C.; Humia, Gleberson; Khosravi, Ali; Revellin, Rémi; Bonjour, Jocelyn; Machado, Luiz

## Experimental study on the void fraction during two-phase flow of R1234yf in smooth horizontal tubes

*Published in:*

INTERNATIONAL JOURNAL OF REFRIGERATION-REVUE INTERNATIONALE DU FROID

*DOI:*

[10.1016/j.ijrefrig.2019.05.007](https://doi.org/10.1016/j.ijrefrig.2019.05.007)

Published: 01/08/2019

*Document Version*

Peer-reviewed accepted author manuscript, also known as Final accepted manuscript or Post-print

*Published under the following license:*

CC BY-NC-ND

*Please cite the original version:*

Garcia Pabon, J. J., Pereira, L. C., Humia, G., Khosravi, A., Revellin, R., Bonjour, J., & Machado, L. (2019). Experimental study on the void fraction during two-phase flow of R1234yf in smooth horizontal tubes. *INTERNATIONAL JOURNAL OF REFRIGERATION-REVUE INTERNATIONALE DU FROID*, 104, 103-112. <https://doi.org/10.1016/j.ijrefrig.2019.05.007>

---

This material is protected by copyright and other intellectual property rights, and duplication or sale of all or part of any of the repository collections is not permitted, except that material may be duplicated by you for your research use or educational purposes in electronic or print form. You must obtain permission for any other use. Electronic or print copies may not be offered, whether for sale or otherwise to anyone who is not an authorised user.

## Accepted Manuscript

Experimental study on the void fraction during two-phase flow of R1234yf in smooth horizontal tubes

Juan J. Garcia Pabon , Leandro C. Pereira , Gleberon Humia ,  
Ali Khosravi , Rémi Revellin , Jocelyn Bonjour , Luiz Machado

PII: S0140-7007(19)30203-8  
DOI: <https://doi.org/10.1016/j.ijrefrig.2019.05.007>  
Reference: JIJR 4386

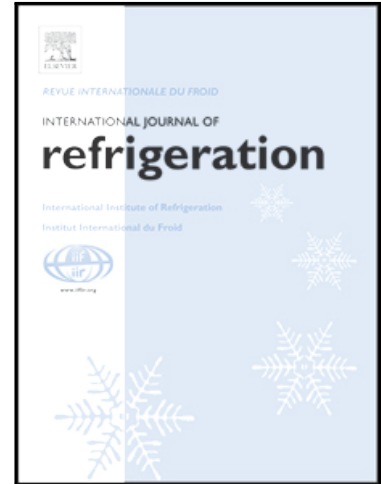

To appear in: *International Journal of Refrigeration*

Received date: 27 February 2019  
Revised date: 30 April 2019  
Accepted date: 7 May 2019

Please cite this article as: Juan J. Garcia Pabon , Leandro C. Pereira , Gleberon Humia , Ali Khosravi , Rémi Revellin , Jocelyn Bonjour , Luiz Machado , Experimental study on the void fraction during two-phase flow of R1234yf in smooth horizontal tubes, *International Journal of Refrigeration* (2019), doi: <https://doi.org/10.1016/j.ijrefrig.2019.05.007>

This is a PDF file of an unedited manuscript that has been accepted for publication. As a service to our customers we are providing this early version of the manuscript. The manuscript will undergo copyediting, typesetting, and review of the resulting proof before it is published in its final form. Please note that during the production process errors may be discovered which could affect the content, and all legal disclaimers that apply to the journal pertain.

## Highlights

- Experiments on void fraction of R1234yf in a horizontal smooth tube
- Effects of experimental conditions on void fraction of R1234yf is analyzed
- Experimental data of void fraction of R1234yf are compared with correlations
- The quick close valve method was used to measure the local void fraction

# Experimental study on the void fraction during two-phase flow of R1234yf in smooth horizontal tubes

Juan J. Garcia Pabon<sup>a,b\*</sup>, Leandro C. Pereira<sup>b,e</sup>, Gleberson Humia<sup>b</sup>, Ali Khosravi<sup>c</sup>, Rémi Revellin<sup>d</sup>,  
Jocelyn Bonjour<sup>d</sup>, Luiz Machado<sup>b</sup>

<sup>a</sup> Institute of Mechanical Engineering, Universidade Federal de Itajubá, Itajubá, Brazil

<sup>b</sup> Programa de Pós-graduação em Engenharia Mecânica, Universidade Federal de Minas Gerais, Belo Horizonte, Brazil

<sup>c</sup> Department of Mechanical Engineering, School of Engineering, Aalto University, Helsinki, Finland

<sup>d</sup> Univ Lyon, CNRS, INSA-Lyon, Université Claude Bernard Lyon 1, CETHIL UMR5008, Villeurbanne, France

<sup>e</sup> Departamento de Engenharia de Materiais, Centro Federal de Educação Tecnológica de Minas Gerais, Belo Horizonte, Brazil

\* Corresponding author email: jjgp@unifei.edu.br, Tel. +5531975597148

## Abstract

Void fraction is an important parameter to design and simulate thermal systems involving two-phase flows. In this research, an experimental investigation of the void fraction in adiabatic two-phase flow of R1234yf in horizontal and smooth tubes with an internal diameter of 4.8 mm was carried out. For the experimental tests, the vapor quality ranges from 0.1 to 1 while two saturation temperatures (15 and 25°C) and two mass flow rates (180 and 280 kg.m<sup>-2</sup>s<sup>-1</sup>) are investigated. The quick-closing valve(s) method is used to measure the volumetric void fraction. Tests are also undertaken with R134a used as a reference in this study. The results highlight that the void fraction of R1234yf is 5% lower than that for R134a. In addition, the experimental data of R1234yf were compared against seven correlations from the literature: the Baroczy and the Hughmark correlations were shown to provide the best prediction, with a mean absolute error of 2% and 3.2%, respectively.

**Keywords:** Void fraction; quick-closing valve(s) method; R1234yf; R134a; Two-phase flow; Smooth horizontal tubes

Nomenclature		Greek symbols	
$D$	diameter (m)	$\alpha$	void fraction
$E$	electric voltage (V)	$\rho$	density (kg.m <sup>-3</sup> )
$Fr$	Froude number	$\sigma$	surface tension (N.m <sup>-1</sup> )
$G$	mass flux (kg s <sup>-1</sup> m <sup>-2</sup> )	$\chi$	Martinelli parameter
$g$	gravity (m s <sup>-2</sup> )	$\eta$	efficiency
$M$	mass (g)	$\mu$	viscosity (Pa s)
$\dot{m}$	mass flow (kg s <sup>-1</sup> )	<b>subscripts</b>	
$Q$	heat flux (W m <sup>-2</sup> )	<i>exp</i>	experimental
$S$	slip ratio	<i>in</i>	inlet
$U$	velocity (m s <sup>-1</sup> )	<i>l</i>	liquid
$T$	temperature (°C)	<i>lv</i>	liquid-vapor
$V$	volume (m <sup>3</sup> )	<i>out</i>	outlet
$x$	vapor quality	<i>ph</i>	preheater
		<i>pred</i>	predicted
		<i>tp</i>	two-phase
		<i>ts</i>	test section
		<i>v</i>	vapor

# 1 INTRODUCTION

In recent years, many researches in the field of engineering were motivated by the global environmental concerns. They were aiming at developing and optimizing the conventional engineering systems, or at introducing new materials and configurations for industrial equipment (Khosravi et al., 2019). R134a is an extremely common refrigerant used in a wide range of refrigeration systems and air conditioning (both domestic and commercial) including small and medium capacity and medium and high temperature refrigeration (Khosravi et al., 2018). However, this fluid has a high Global Warming Potential ( $GWP=1340 \text{ t CO}_2 \text{ eq}$ ), and it is responsible for 2% of the greenhouse gases present in the atmosphere (Thompson, 2013). International regulations (e.g. the directive 517/2014 of Europe Union) impose that R134a should phase out and be replaced (Sánchez et al., 2017).

Among several candidates to substitute this fluid, R1234yf ( $GWP<1 \text{ t CO}_2 \text{ eq}$ ) is a great option (Garcia et al., 2018). The thermophysical properties of R1234yf are similar to R134a (Cho and Park, 2016). Several investigations evaluated and compared the performance of R134a and R1234yf as working fluid in refrigeration and air conditioning systems (Garcia et al., 2018). Initially, the efficiency of R1234yf refrigerant has been studied in automotive systems (Lee and Jung, 2012; Qi, 2015, 2013). Nowadays, researches continue to study the efficiency of R1234yf in other refrigeration equipment. For example, Belman-Flores et al. (2017) studied the efficiency of R1234yf in domestic refrigerator; Nawaz et al. (2017) and Botticella et al. (2017) applied R1234yf in residential heat pumps. These investigations showed that R1234yf can be considered as an alternative for R134a with the same efficiency and without large changes on the equipment.

In addition, for this substitution, characterizing the behavior of R1234yf during two-phase flow is fundamental. Many studies focused on the evaluation of the heat transfer coefficient of R1234yf (Anwar et al., 2015; Choi et al., 2014; Del Col et al., 2013, 2010; Illán-Gómez et al., 2015; Li et al., 2012; Lu et al., 2013; Mortada et al., 2012; Saitoh et al., 2011; Sempértegui-Tapia and Ribatski, 2017; Wang et al., 2012). Padilla et al. (2011) investigated the two-phase flow patterns of R1234yf. Mastrullo et al. (2017, 2016) studied the critical heat flux during flow boiling of R1234yf. However, the void fraction for R1234yf was no studied.

The volumetric void fraction is defined as the ratio between the volume of vapor and the total volume of a two-phase liquid-vapor mixture. This parameter is crucial for the determination of the inventory, which is the quantity of mass fluid refrigerant in refrigeration systems. The void fraction

is predicted with a variety of prediction tools (semi-empirical correlations or models) available in the literature.

There are several measurement methods to determine the void fraction, among which the capacitance, conductance, optical, ultrasonic, or radiative methods are renowned (Tompkins et al., 2018). Radiative methods are non-intrusive techniques that employ radiations such as neutron, gamma, and X-rays. The radiative methods are expensive compared to other methods, and precautions must be taken for radiation source. The sonic methods (that use ultrasound or acoustic transmissions) are limited to the low vapor fractions. The processing of ultrasonic techniques requires significant computational effort and small changes in the setup geometry have a large impact on the accuracy of the results (Schabowicz, 2014). The optical-based methods use the attenuation of light or laser. These methods also have the disadvantages of high cost and higher requirements of the measurement environment (Li et al., 2016). The visualization method includes high-speed cameras, digital cameras, and optical tomography, etc. The information extracted from these 2D images is limited (Li et al., 2017). Electrical methods are based on the difference in the permittivity, conductivity or impedance between the fluid phases. Their accuracy depends significantly on the flow regime (Paranjape et al., 2012).

In addition to the methods mentioned above, the void fraction can be measured by quick-closing valves (QCV) method. Two valves are located upward and downward of the test section and actuated (closed) simultaneously causing an almost immediate two-phase flow interruption. Following, the contained mass fluid is measured. The cross-section area and length of the tube are known, then the average void fraction can be deduced from the measurement of fluid mass. This method has an advantage that can be employed for any flow patterns with a low cost and low uncertainty. The QCV method was used to obtain the results published in the present research.

Experimental studies involving the QCV method were performed by Abdul-Majeed (1996) for kerosene-air two-phase flow, and Sujumong (1997) for water-glycerine two-phase flow. Rocha and Simões-Moreira (2008) used the QCV method and Multiple-Electrode Impedance Sensors to measure void fraction in air-water two-phase flow in a vertical tube. The QCV method was considered as calibration standard for void fractions ranging from 0.17 to 0.7 and had an overall void fraction measuring uncertainty of 0.05. Funahashi et al (2018) measured the void fraction of air-water flow by the QCV method with an uncertainty of 0.15%. Recently, Qian and Hrnjak (2019) measured the void fraction by the QCV in horizontal and vertical round smooth tubes (ID 7 mm) with R134a in the adiabatic conditions, saturation temperature at 33°C and low mass fluxes (40-150

kg/m<sup>2</sup>s). They concluded that the void fraction of horizontal tubes is larger than that of vertical tubes, and higher mass flux also results in larger void fraction compared that of lower mass flux.

Based on the literature, many studies were conducted to investigate R1234yf from different aspects including the efficiency in refrigeration systems, size of the components, two-phase flow patterns, and critical heat flux. The present investigation focuses on of the void fraction of R1234yf. For this target, several experimental tests using the quick-closing valves method are performed for R1234yf, as well as for R134a that is considered as a well-known reference. The void fractions for both fluids are compared and presented. The effect of saturation temperature, mass flux and vapor quality on void fraction is analyzed. In addition, a compare son between the experimental data and classical prediction tools is carried out.

## 2 EXPERIMENTAL SETUP

Figure 1 shows a schematic of the experimental setup used to measure the void fraction. The refrigerant loop is made of a copper tube with an internal diameter of 4.8 mm and consists of a self-lubricating oil-free gear micropump (series GJ of MICROPUMP INC) which delivers subcooled refrigerant to the heater. The refrigerant is preheated and partially evaporated in the heater to the desired vapor quality. The fluid passes through the test section (2 m length and 4.8 mm inner diameter), and then, the fluid is condensed and subcooled in the condenser. Finally, the refrigerant returns to the micropump as a subcooled liquid. To reduce the heat exchange with the surroundings, the entire apparatus was insulated. The refrigerant flow rate can be controlled by adjusting the frequency of the magnetic gear pump. The vapor quality at the inlet of the test section can be adjusted by the heating power supplied to the refrigerant in the pre-heater. The pressure can be controlled in the condenser by means of water loop, whose temperature can be chosen by the operator owing to an auxiliary refrigeration system. A sub-tank with a water bath was used to control the amount of refrigerant in the circuit for each test.

Thermocouples and pressure transducers were installed in various position of refrigerant loop to determine the fluid conditions. The accuracy of the T-type thermocouples was within  $\pm 0.2^{\circ}\text{C}$ . The pressure was measured using calibrated manometers (Novus, model NP460) with an accuracy of  $\pm 0.02$  bar. The facility also included a turbine-type flow meter (Kobold, model DPM-1130) with accuracy of  $\pm 3.0\%$ . The electrical input power in the pre-heater was measured using a voltmeter and amperemeter with accuracy of  $\pm 1.6\%$ .



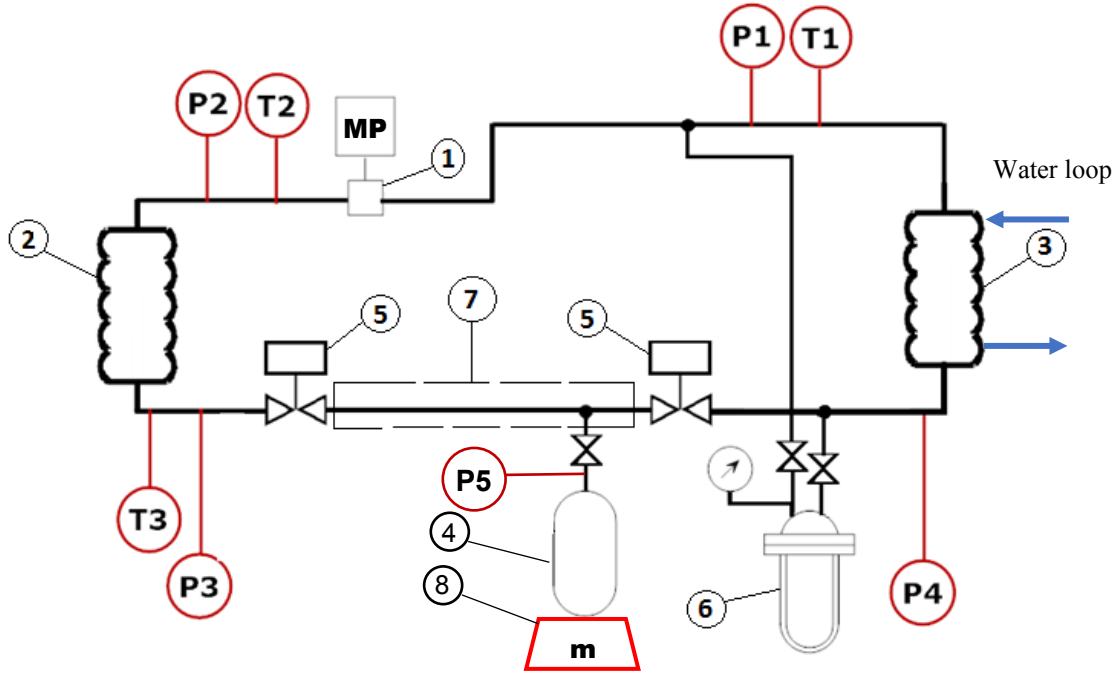

Figure 1. Test bench including: 1-magnetic micropump; 2-heater; 3-condenser; 4-bottle; 5-solenoid valve; 6-sub-tank; 7-test section; 8-Balance scale.

Tubes of 0.5 m length and 4.8 mm inner diameter were located at upstream and downstream of the test section to achieve a fully-developed flow condition. To operate the measurement of the void fraction with QCV methods, two solenoid valves (Normally Closed) with same inner diameter of test section were controlled by computer. A third valve was located in the downstream of the test section to link the bottle. A hole with 0.5 mm diameter was made in the wall (up position) of the test section to connect the third valve. This configuration minimizes the influence of junction on flow.

Once steady state was reached, the valves were closed. The accumulated fluid in the test section was conducted to a bottle (previously in vacuum) by opening the third valve which links the test section with the bottle. The test section is heated for a short period of time to fully evaporate the fluid in the tests section. When the thermal and mechanical equilibrium between the test section and the bottle was reached, the third valve is closed and the bottle is weighed by a precision scale (model AD2000 MARTE) with uncertainty of  $\pm 0.1\text{g}$ .

## 2.1 Data reduction

The mass flux is calculated as:

$$G = \frac{4\dot{m}}{\pi D^2} \quad (1)$$

where  $\dot{m}$  is the measured mass flow rate and  $D$  is the internal cross-sectional area of the tube.

The flashing effect was calculated based on equation developed by Revellin et al. (2012), and was found to be negligible. Thus, the vapor quality at the outlet of the preheater could be determined through a simple energy balance over the preheater.

$$x_{ph,out} = \frac{1}{i_{lv,ph}} \left( \frac{\dot{Q}_{ph}}{\dot{m}} - (i_{l,ph} - i_{ph,in}) \right) \quad (2)$$

where  $i_{ph,in}$  is the enthalpy of the liquid at the inlet of the preheater,  $i_{l,ph}$  is the enthalpy of the saturated liquid and  $i_{lv,ph}$  is the latent heat of vaporization considering the saturation temperature at the outlet of the preheater (inlet of the test section). The  $\dot{Q}_{ph}$  is the heat rate in the preheater:

$$\dot{Q}_{ph} = \eta_{ph} E_{ph} I_{ph} \quad (3)$$

where  $E_{ph}$  and  $I_{ph}$  are the voltage and current electrically applied in the preheater.  $\eta_{ph}$  is the efficiency between heat and electrical power in the preheater. It was identified owing to preliminary single-phase experimental calibration ( $\eta_{ph} = 0.93$ ).

Finally, the void fraction in the test section is calculated as:

$$\alpha = \left( \rho_l - \frac{M_{ts}}{V_{ts}} \right) (\rho_l - \rho_v)^{-1} \quad (4)$$

where  $M_{ts}$  and  $V_{ts}$  are the mass and volume of fluid contained in the test section,  $\rho_l$  and  $\rho_v$  are the liquid and vapor density, respectively, at the considered saturation temperature.  $V_{ts}$  was measured through the previous measurement regarding volume of water into the test section (prior to running the experiment).

The mass of fluid in the test section was calculated as the sum of mass of fluid contained in the bottle measured with the balance and the mass of the vapor constrained in the test section after the equilibrium with the bottle had been reached (the vapor density is a function of room temperature and pressure in the steady state of test section-bottle set). The preliminary single-phase experiments mentioned previously were mostly made to validate the QCV method. They essentially consisted in applying the methodology described previously to a single-phase flow, i.e. trap a certain amount of liquid in the test section, let the equilibrium establish with the bottle, weigh the bottle and apply

Eq. (4). This was done for different mass fluxes and saturation temperatures. Obviously, a void fraction equal to zero was expected independently of the experimental conditions for such single-phase flow. The standard deviation<sup>1</sup> of the whole dataset of measurements for these single-phase flow tests was found to be 0.045, so that the QCV was validated.

## 2.2 Uncertainty analysis

The uncertainty analysis was carried out to assess the quality and the repeatability of the experimental data following the procedure exposed by Moffat (1988). The known accuracy of instruments (refrigerant and water mass flow meters, current sensor, voltage sensor, pressure sensors, and scale) coupled with calibrated accuracy of thermocouples was used to evaluate the uncertainty propagation of the calculated parameters as vapor quality, mass flux and void fraction. The uncertainties are summarized in Table 1.

Table 1. Uncertainties

Parameter	Uncertainty
Internal diameter	± 0.4%
Tube length	± 0.1%
Refrigerant mass flow rate	± 2.5%
Electric current	± 1.5 %
Electric voltage	± 1.8 %
Pressure	± 0.2 bar
Temperature	± 0.5 °C
Mass fluid	± 0.5 g
Mass flux	± 3.4 %
Vapor quality	± 3.8 %*
Void fraction	± 4.7 %*

\*the maximum value at low vapor qualities

Especially, Eq. (4) shows that the experimental void fraction depends on four parameters:

$$\alpha = f(\rho_l, \rho_g, V_{ls}, M_{ls}) \quad (5)$$

<sup>1</sup> standard deviation =  $\sqrt{\frac{1}{N} \sum_{i=1}^N \alpha_i^2}$

The uncertainty for the void fraction is calculated from the propagation of the uncertainty for these parameters, based on the method of Taylor (1994).

$$u_{\alpha}^2 = \left[ \left( \frac{\partial \alpha}{\partial \rho_l} \right) u_{\rho_l} \right]^2 + \left[ \left( \frac{\partial \alpha}{\partial \rho_v} \right) u_{\rho_v} \right]^2 + \left[ \left( \frac{\partial \alpha}{\partial V_{ts}} \right) u_{V_{ts}} \right]^2 + \left[ \left( \frac{\partial \alpha}{\partial M_{ts}} \right) u_{M_{ts}} \right]^2 \quad (6)$$

$$u_{\alpha}^2 = \left[ \left( \frac{\partial \alpha}{\partial \rho_l} \right) \left( \frac{\partial \rho_l}{\partial T_{sat}} u_{T_{sat}} \right) \right]^2 + \left[ \left( \frac{\partial \alpha}{\partial \rho_v} \right) \left( \frac{\partial \rho_v}{\partial T_{sat}} u_{T_{sat}} \right) \right]^2 + \left[ \left( \frac{\partial \alpha}{\partial V_{ts}} \right) \left( \left( \frac{\partial V_{ts}}{\partial L_{ts}} u_{L_{ts}} \right)^2 + \left( \frac{\partial V_{ts}}{\partial D} u_D \right)^2 \right)^{\frac{1}{2}} \right]^2 + \left[ \left( \frac{\partial \alpha}{\partial M_{ts}} \right) u_{M_{ts}} \right]^2 \quad (7)$$

where  $u$  in the relative uncertainty. When the saturation temperature and mass flux are fixed. The last term of Eq. 7 varies with the vapor quality because the mass of fluid contained in the test section changes with vapor quality. Fig. 2 shows the uncertainty in the void fraction, as calculated by Eq. 7 with the data given in Table 1. The uncertainty in void fraction increases when the vapor quality decreases.

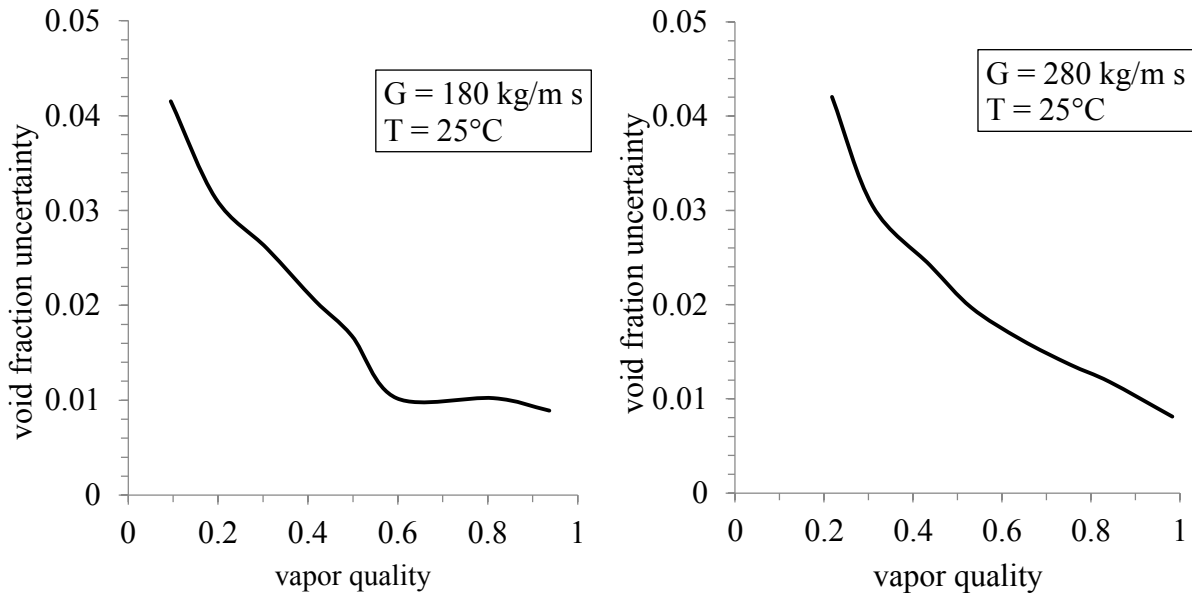

Figure 2. Uncertainty of void fraction in function of vapor quality.

### 3 CORRELATIONS

Void fraction is a critical unknown parameter involved in the prediction of the pressure drop and heat transfer during two-phase flow, as well as of the charge of two-phase systems. The determination of void fraction from input conditions in a given tube (such as mass flux, vapor quality, tube diameter and saturation temperature) is complicated, due to the slip ratio, i.e. the ratio between the velocities of vapor and liquid phases. Because of the complexity and lack of understanding of the basic underlying physics of the problem, the majority of the analyses were more inclined towards semi-empirical correlations.

The void fraction correlations can be classified in four groups defined and named by Woldesemayat and Ghajar (2007): “slip ratio correlations”, “ $K\alpha_H$  correlations”, “drift flux correlations” and “general correlations”.

#### *Slip ratio correlations*

The correlations of this group explicitly account for the effect of the slip ratio and can be written in a general form as

$$\alpha = \left[ 1 + \left( \frac{1-x}{x} \right) \left( \frac{\rho_v}{\rho_l} \right) S \right]^{-1} \quad (8)$$

with

$$S = \frac{U_v}{U_l} \quad (9)$$

Where  $S$ ,  $U_v$  and  $U_l$  are the slip ratio, and vapor and liquid velocities, respectively. The correlations of Baroczy (1963), Zivi (1964) and Butterworth (1975) belong to this category.

The homogeneous model or non-slip void fraction considers both phases as the homogeneous mixture, i.e., the vapor and liquid phases flow with same velocity,  $S = 1$ .

$$\alpha_H = \left[ 1 + \left( \frac{1-x}{x} \right) \left( \frac{\rho_v}{\rho_l} \right) \right]^{-1} \quad (10)$$

This model can be applied where the vapor and liquid velocities are close the one to the other (e.g. for bubbly flow or mist flow patterns), or for high mass flux (El Hajal et al., 2003).

#### *Ka<sub>H</sub> correlations*

The correlations belonging to this category involve a parameter that multiplies the void fraction calculated by the homogenous model. Bankoff (1960) named that constant K. Hugmark (1961) proposed that the K constant should be based on the mass flow rate of two-phase mixture, and introduced the Froud number and the Reynolds number.

#### *Drift flux correlations*

These correlations take into consideration the non-uniformity in the flow captured by a distribution parameter ( $C_0$ ), and the drift velocity ( $U_{vm}$ ), defined as the difference between the vapor phase velocity ( $U_v$ ) and the two-phase mixture velocity ( $U_m$ ). The superficial vapor velocity ( $U_{sv}$ ) has an equally important part in the expression as is shown:

$$\alpha = \frac{U_{sv}}{C_0 U_m + U_{vm}} \quad (11)$$

Note that if  $U_{vm} = 0$  and  $C_0 = 1$ , the equation resembles the homogeneous model.

## General correlations

Woldesemayat and Ghajar (2007) classified as belonging to the category of general correlations all those that use other physical parameters, such as the Martinelli parameter ( $\chi$ ), the Froude number (Fr) or the Weber number (We), among others.

## Selected correlations

Table 2 shows the chosen correlations, namely the correlations of Zivi (1964), Hugmark (1961), Rouhani and Axelsson (1970), Domanski and Didion (1983), Baroczy (1963) and Kanizawa and Ribatski (2016), for investigating the experimental data concerning the void fraction. The decision was made to choose at least one correlation of each group and also the correlations commonly used in the literature for horizontal and macro-channels. Wojtan et al. (2005) used Zivi (1964) and Rouhani and Axelsson (1970) correlations to assess the experimental data. Woldesemayat and Ghajar (2007) recommended Hugmark (1961) correlation for horizontal flow. Kanizawa and Ribatski (2016) recently developed a novel method based on a huge database to analyze the void fraction parameter. Finally, Domanski and Didion (1983) and Baroczy (1963) are classical methods that have been utilized in many studies (El Hajal et al., 2003).

Table 2. Void fraction correlations.

Author	equation	type	fluid	conditions	comments
Zivi (1964)	$\alpha = \left[ 1 + \frac{\rho_v}{\rho_l} \left[ \frac{1-x}{x} \right] \left[ \frac{\rho_v}{\rho_l} \right]^{\frac{1}{3}} \right]^{-1}$	Slip ratio	-	Vertical and horizontal flow	Based on the minimum kinetic energy
Hugmark (1961)	$\alpha = K \cdot \alpha_H$ $K = \begin{cases} 1.7 \times 10^{-3} z^3 - 3.93 \times 10^{-2} z^2 + 0.3258z - 0.1792 \\ 2 \times 10^{-7} z^3 - 6 \times 10^{-5} z^2 + 6.1 \times 10^{-3} z + 0.7257 \end{cases}$ <i>for</i> $z < 8$ <i>for</i> $z \geq 8$ $z = \left[ \frac{D \cdot G}{\mu_l + \alpha(\mu_v - \mu_l)} \right]^{\frac{1}{6}} \left[ \frac{1}{g \cdot D} \left[ \frac{Gx}{\rho_v \alpha_H (1 - \alpha_H)} \right]^2 \right]^{\frac{1}{8}}$	$K\alpha_H$	air-water air-kerosene air-benzene	-	Incorporate the change phase effects
Rouhani and Axelsson (1970)	$\alpha = \frac{x}{\rho_v} \left[ (1 + 0.12(1-x)) \left[ \frac{x}{\rho_v} + \frac{1-x}{\rho_l} \right] + \frac{1.18(1-x)(g\sigma(\rho_l - \rho_v))}{G(\rho_l^{0.5})} \right]^{-1}$	Drift	-	Annular pattern	Valid for condensation

Domanski and Didion (1983)	$\alpha = (1 + \chi^{0.8})^{-0.78} \quad \text{for } \chi \leq 10$ $\alpha = 0.23 - 0.157 \ln(\chi) \quad \text{for } \chi > 10$	General	various mixture with air	-	Range diameter analysis
Baroczy (1963)	$\alpha = \left[ 1 + \left( \frac{1-x}{x} \right)^{0.74} \left( \frac{\rho_v}{\rho_l} \right)^{0.65} \left( \frac{\mu_l}{\mu_v} \right)^{0.13} \right]^{-1}$	Slip ratio	Air-water Nitrogen-mercury	-	-
Kanizawa and Ribatski (2016)	$\alpha = \left[ 1 + 1.021 Fr^{-0.092} \left( \frac{\mu_l}{\mu_v} \right)^{-0.368} \left( \frac{\rho_v}{\rho_l} \right)^{\frac{1}{3}} \left( \frac{1-x}{x} \right)^{\frac{2}{3}} \right]^{-1}$	General	-	$G < 1515 \text{ kg}\cdot\text{m}^{-2}\cdot\text{s}^{-1}$ ; $\alpha < 0.36$	Based on the minimum kinetic energy

## 4 RESULTS

In this section, the results of experimental tests are presented: this investigation of the void fraction for R1234yf and R134a in adiabatic conditions inside a smooth horizontal tube was done for two mass fluxes (180 and 280 kg/m<sup>2</sup>s), two saturation temperatures (15°C and 25°C) and for a vapor quality ranging from 0.1 to 1. A total of 53 points were collected during the tests.

### 4.1 Effect of mass flux

The mass flux is an important parameter for evaluation of the two-phase flow. However, the mass flux does not significantly affect the void fraction. Fig. 3 demonstrates that by increasing the mass flux from 180 to 280 kg/m<sup>2</sup>s, only a slight increase of the void fraction is visible for some points, probably due to fact that the increase in the mass flux is limited, which results in a non-significant change in the void fraction. The increase of entrainment ratio with mass flux is negligible which leads to a very small effect of the mass flux at high vapor quality.



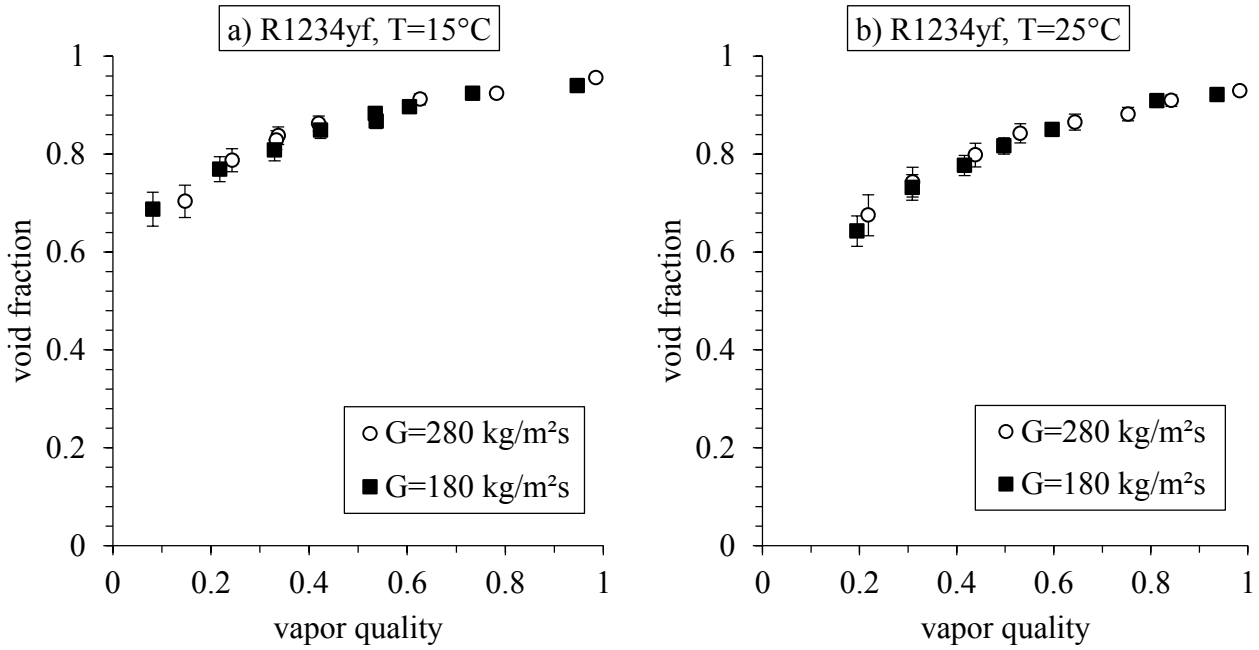

Figure 3: Effect of mass flux on the void fraction at saturation temperature (a)  $T_{\text{sat}}=15^{\circ}\text{C}$ ; (b)  $T_{\text{sat}}=25^{\circ}\text{C}$

## 4.2 Effect of the saturation temperature

Figure 4 represents the void fraction of R1234yf as a function of the vapor quality for a given mass flux and two saturation temperatures. The void fraction increases with the vapor quality, but not linearly. The uncertainty bars underline that, as explained previously, the uncertainties are larger at low than at high void fraction. Increasing the saturation temperature results in a decrease of the void fraction. This behavior can be explained by the reduction of the density ratio ( $\rho_l/\rho_v$ ) when increasing the saturation temperature, as shown in Table 3. As a result, the slip ratio increases and the void fraction decreases. This general trend is easily captured from Eq. 8 (homogeneous model) and it is respected by the subsequent correlations.

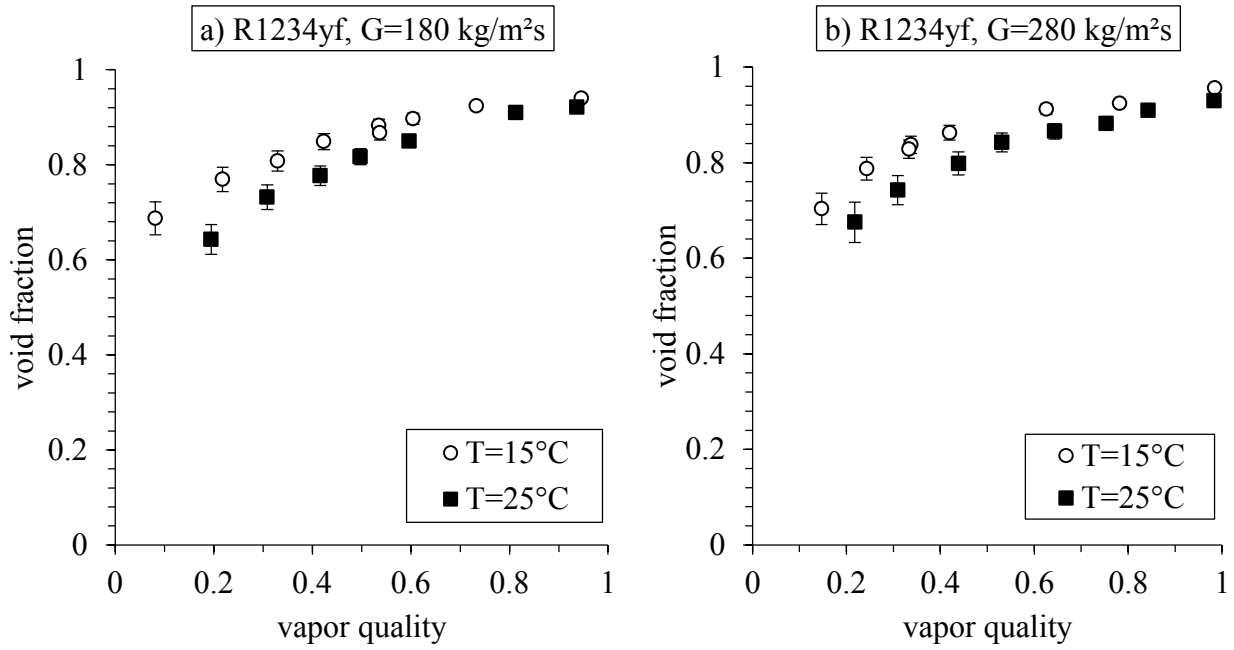

Figure 4: Effect of temperature on the void fraction at mass flow: (a)  $G=180 \text{ kg/m}^2 \text{ s}$  ; (b)  $G=280 \text{ kg/m}^2 \text{ s}$

Table 3. Thermodynamic properties of R134a and R1234yf at similar operating conditions

Fluid	$T_{sat}$ °C	$P_{sat}$ bar	$\sigma$ $mN.m^{-1}$	$\rho_l$ $kg.m^{-3}$	$\rho_v$	$\rho_l/\rho_v$ -	$\mu_l$ $mPa.s$	$\mu_v$	$\mu_l/\mu_v$ -
R134a	15	4.88	9.36	1243	23.78	52.29	0.22	0.0115	19.07
	25	6.66	8.03	1207	32.37	37.27	0.1944	0.0119	16.24
R1234yf	15	5.10	7.44	1127	28.32	39.81	0.1722	0.0109	15.75
	25	6.83	6.19	1093	37.94	28.79	0.153	0.0114	13.39

### 4.3 Comparison between R1234yf and R134a

Figure 5 shows the measured void fraction for R134a and R1234yf versus the vapor quality for a saturation temperature equal to  $15^\circ\text{C}$  and for both studied mass fluxes. Generally, at a given vapor quality, the void fraction for R134a is slightly higher than that for R1234yf, mainly in low mass flux. This is due to the fact that for a given temperature, R1234yf has a higher saturation pressure and thus a higher vapor density that causes the vapor to flow at a lower velocity.

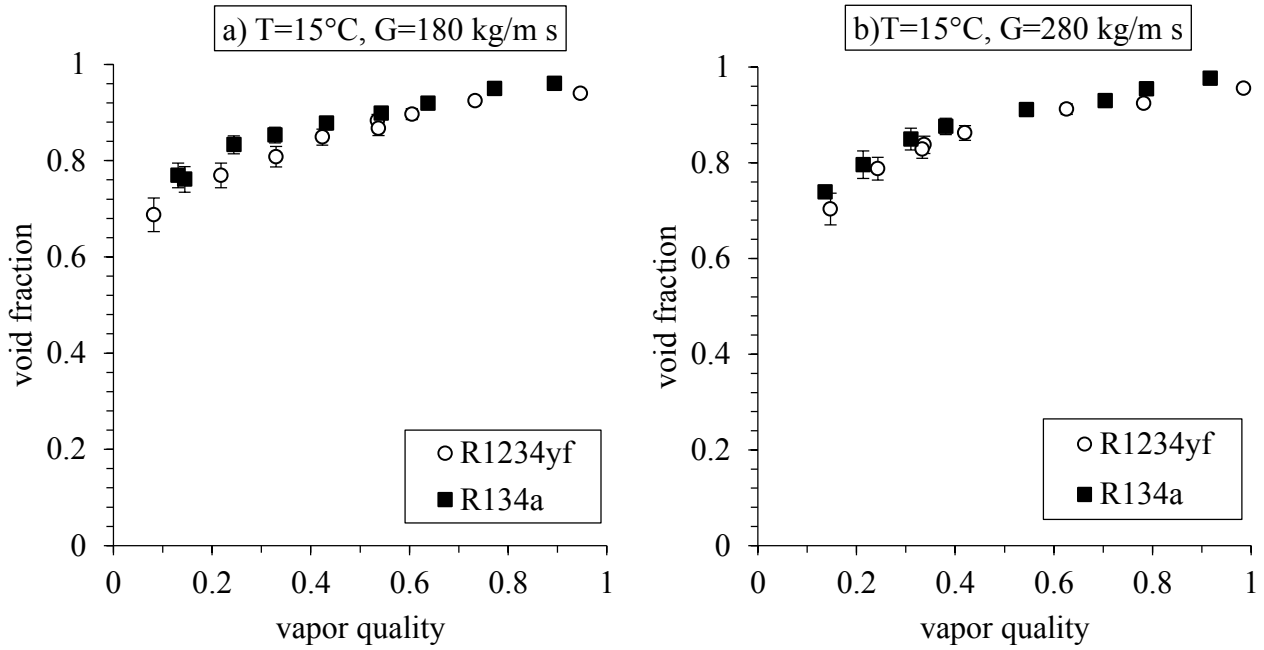

Figure 5: experimental void fraction. a)  $G=180 \text{ kg/s}$  and b)  $G=280 \text{ kg/s}$ .

#### 4.4 Comparison of experimental results with existing correlations

In this section, the R1234yf experimental data are compared with the predictions obtained from the various correlations of the literature mentioned in Table 2. The homogeneous model, and Zivi (1964), Hugmark (1961), Rouhani and Axelsson (1970), Domanski and Didion (1983), Baroczy (1963) and Kanizawa and Ribatski (2016) correlations were chosen to compare with the experimental data. This allows a comparison with at least one correlation belonging to each category. Figure 6 depicts how the R1234yf experimental data compares with the seven correlations.

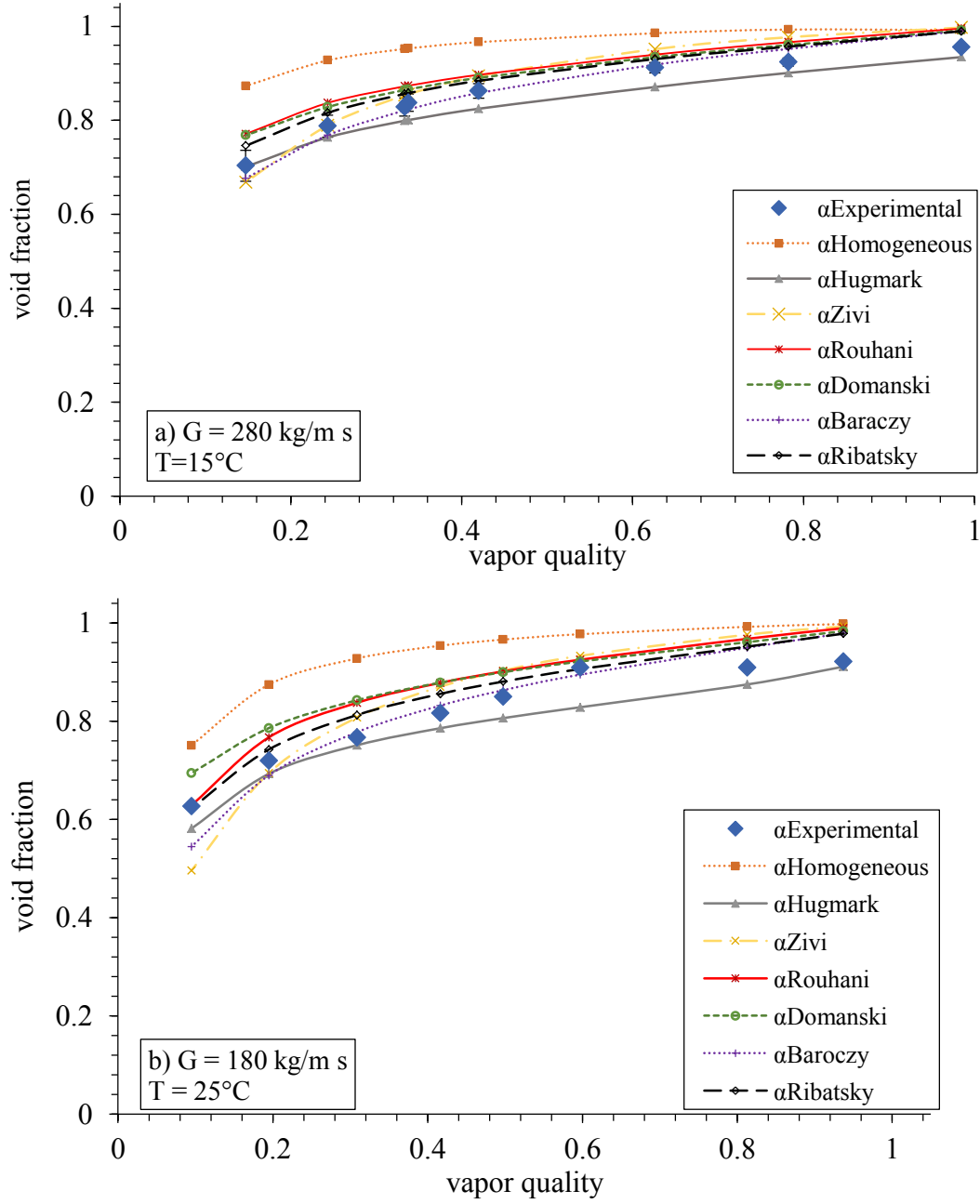

Figure 6: comparison of void fraction for R1234yf of different with models of open literature

The Baroczy (1963) and Hugmark (1961) correlations present the best prediction and trend, while all the other correlations tend to over predict the data on the whole range of values.

The performance of all correlations as the percentage of MRD (mean relative deviation) and MARD (mean absolute relative deviation) is presented in Table 3.

$$MRD = \frac{1}{n} \sum_{i=1}^n \frac{\alpha_{pred} - \alpha_{exp}}{\alpha_{exp}} \times 100 \quad (12)$$

$$MARD = \frac{1}{n} \sum_{i=1}^n \left| \frac{\alpha_{pred} - \alpha_{exp}}{\alpha_{exp}} \right| \times 100 \quad (13)$$

Table 3. Deviation of correlations

Correlation	MRD	MARD
Homogenous	11,0	11,0
Hugmark (1965)	- 3,2	3,2
Zivi (1964)	2,2	3,4
Rouhani and Axelsson (1970)	4,9	4,9
Domanski and Didion (1983)	4,2	4,2
Baroczy (1965)	- 0,2	2,0
Kanizawa and Ribatski (2016)	3,3	3,3

It is observed that the Baroczy (1963) correlation is the best, with a MARD equal to 2.0%. Some others correlations also show quite low errors: Hugmark (1961) (3.2%), Zivi (1964) (3.4%), Kanizawa and Ribatski (2016) (3.3%) and Domanski and Didion (1983) (4.2%). The correlation of Rouhani and Axelsson (1970) and the homogenous model shows the worst agreements, with a MARD of 4.9% and 11.0%, respectively.

A simple scatter plot of the calculated void fractions vs the measured experimental data is presented in Fig. 7 for the Hugmark (1961) and Baroczy (1963) correlations. These graphs reveal that 100% of the datapoints are within a  $\pm 10\%$  error band.

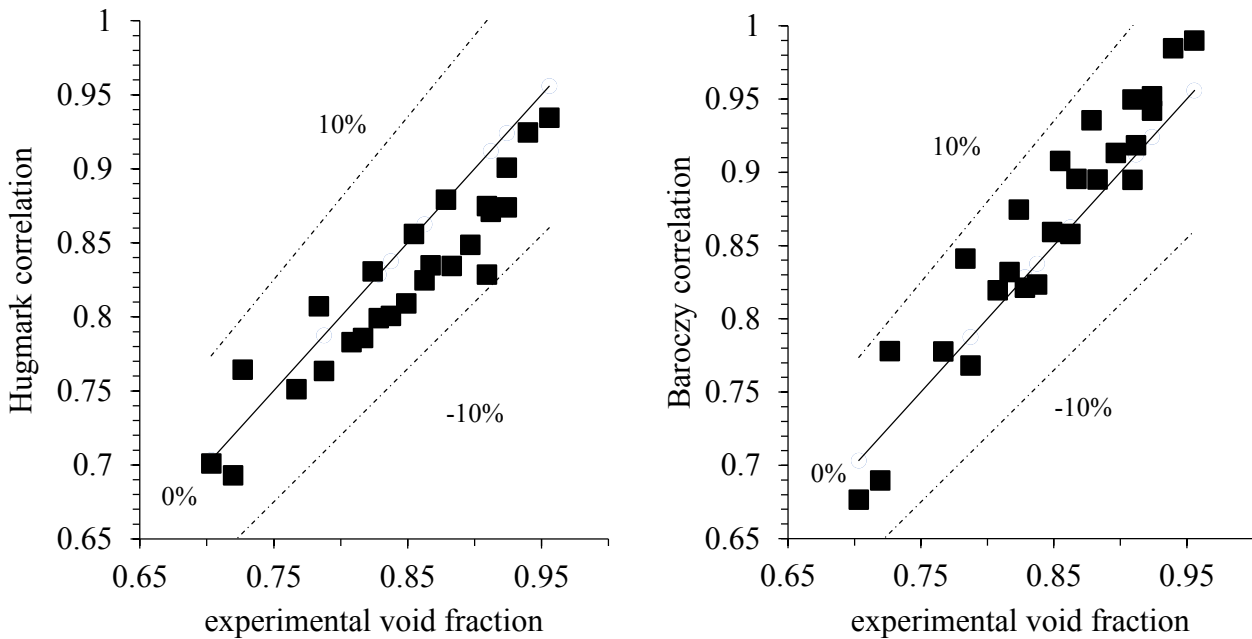

Figure 7: experimental void fraction vs Hugmark and Baroczy correlations for R1234yf.

## 5 CONCLUSION

An experimental investigation of the void fraction of R1234yf in two-phase flow in smooth and horizontal tubes was undertaken. The test conditions were: a tube internal diameter of 4.8 mm; a mass flux of 180 kg/m<sup>2</sup>s or 280 kg/m<sup>2</sup>s; a saturation temperature of 15°C or 25°C; adiabatic conditions; and vapor quality ranging from 0.1 to 1. During the experiments more than 50 points were measured and tests were also performed for R134a as a reference.

The purpose of the tests was to study the effects of vapor quality, mass flux and saturation temperature on the void fraction of R1234yf and R134a. The void fraction increased when decreasing the saturation temperature, due to the decrease of the vapor density. Within the range of test conditions, the mass flux has almost no influence on the void fraction. Additionally, it was observed that for a given vapor quality, the void fraction for R134a is higher than for R1234yf.

The experimental data were used to evaluate the performance of eight void fraction models of correlations for R1234yf. Baroczy (1963) provides reasonable predictions of the experimental database, with a MARD less than 5% and almost all the data predicted within a  $\pm 10\%$  error band. The correlations developed by Kanizawa and Ribatski (2016), Domanski and Didion (1983), Hugmark (1961) and Rouhani and Axelsson (1970), can provide acceptable predictions

(MARD<5%). The use of the homogeneous model is not recommended in the range of studied operating conditions. As a final remark, the authors believe that a similar research would deserve to be conducted in the future for hydrocarbons (e.g. R600a, R290), as these fluids are also often viewed as a track to reduce the environmental effect of refrigeration systems.

## ACKNOWLEDGMENT

The authors appreciate the support of CAPES, CNPq, and FAPEMIG in Brazil. We would also like to express our heartfelt gratitude to Dr. Ricardo Koury (in memoriam), Professor at Federal University of Minas Gerais and dear friend.

## REFERENCES

- Abdul-Majeed, G.H., 1996. Liquid holdup in horizontal two-phase gas—liquid flow. *J. Pet. Sci. Eng.* 15, 271–280. [https://doi.org/10.1016/0920-4105\(95\)00069-0](https://doi.org/10.1016/0920-4105(95)00069-0)
- Anwar, Z., Palm, B., Khodabandeh, R., 2015. Flow boiling heat transfer, pressure drop and dryout characteristics of R1234yf: Experimental results and predictions. *Exp. Therm. Fluid Sci.* 66, 137–149. <https://doi.org/10.1016/j.expthermflusci.2015.03.021>
- Bankoff, S.G., 1960. A Variable Density Single-Fluid Model for Two-Phase Flow With Particular Reference to Steam-Water Flow. *J. Heat Transfer* 82, 265. <https://doi.org/10.1115/1.3679930>
- Baroczy, C.J., 1963. Correlation of liquid fraction in two-phase flow with application to liquid metals, *Chemical Engineering Progress*. U.S. Atomic Energy Commission. <https://doi.org/10.2172/4742622>
- Belman-Flores, J.M., Rodríguez-Muñoz, A.P., Pérez-Reguera, C.G., Mota-Babiloni, A., 2017. Experimental study of R1234yf as a drop-in replacement for R134a in a domestic refrigerator. *Int. J. Refrig.* 81, 1–11. <https://doi.org/10.1016/j.ijrefrig.2017.05.003>
- Botticella, F., de Rossi, F., Mauro, A.W., Vanoli, G.P., Viscito, L., 2017. Multi-criteria (thermodynamic, economic and environmental) analysis of possible design options for residential heating split systems working with low GWP refrigerants. *Int. J. Refrig.* 87, 131–153. <https://doi.org/10.1016/j.ijrefrig.2017.10.030>
- Butterworth, D., 1975. A comparison of some void-fraction relationships for co-current gas-liquid flow. *Int. J. Multiph. Flow* 1, 845–850. [https://doi.org/10.1016/0301-9322\(75\)90038-5](https://doi.org/10.1016/0301-9322(75)90038-5)
- Cho, H., Park, C., 2016. Experimental investigation of performance and exergy analysis of automotive air conditioning systems using refrigerant R1234yf at various compressor speeds. *Appl. Therm. Eng.* 101, 30–37. <https://doi.org/10.1016/j.applthermaleng.2016.01.153>
- Choi, K.I.K.-I., Oh, J.T.J.-T., Saito, K., Jeong, J.S.J.S., 2014. Comparison of heat transfer coefficient during evaporation of natural refrigerants and R-1234yf in horizontal small tube. *Int. J. Refrig.* 41, 210–218. <https://doi.org/10.1016/j.ijrefrig.2013.06.017>

- Del Col, D., Bortolin, S., Torresin, D., Cavallini, A., 2013. Flow boiling of R1234yf in a 1 mm diameter channel. *Int. J. Refrig.* 36, 353–362. <https://doi.org/10.1016/j.ijrefrig.2012.10.026>
- Del Col, D., Torresin, D., Cavallini, A., 2010. Heat transfer and pressure drop during condensation of the low GWP refrigerant R1234yf. *Int. J. Refrig.* 33, 1307–1318. <https://doi.org/10.1016/j.ijrefrig.2010.07.020>
- Domanski, P., Didion, D., 1983. Computer Modeling of the Vapor Compression Cycle With Constant Flow Area Expansion Device, in: NBS Building Science Series 155. p. 160.
- El Hajal, J., Thome, J., Cavallini, A., 2003. Condensation in horizontal tubes, part 1: two-phase flow pattern map. *Int. J. Heat Mass Transf.* 46, 3349–3363. [https://doi.org/10.1016/S0017-9310\(03\)00139-X](https://doi.org/10.1016/S0017-9310(03)00139-X)
- Funahashi, H., Vierow Kirkland, K., Hayashi, K., Hosokawa, S., Tomiyama, A., 2018. Interfacial and wall friction factors of swirling annular flow in a vertical pipe. *Nucl. Eng. Des.* 330, 97–105. <https://doi.org/10.1016/j.nucengdes.2018.01.043>
- Garcia, J., Ali, T., Duarte, W.M., Khosravi, A., Machado, L., 2018. Comparison of transient response of an evaporator model for water refrigeration system working with R1234yf as a drop-in replacement for R134a. *Int. J. Refrig.* 91, 211–222. <https://doi.org/10.1016/j.ijrefrig.2018.04.026>
- Hughmark, G.A., Pressburg, B.S., 1961. Holdup and pressure drop with gas-liquid flow in a vertical pipe. *AIChE J.* 7, 677–682. <https://doi.org/10.1002/aic.690070429>
- Illán-Gómez, F., López-Belchí, A., García-Cascales, J.R., Vera-García, F., 2015. Experimental two-phase heat transfer coefficient and frictional pressure drop inside mini-channels during condensation with R1234yf and R134a. *Int. J. Refrig.* 51, 12–23. <https://doi.org/10.1016/j.ijrefrig.2014.11.014>
- Kanizawa, F.T., Ribatski, G., 2016. Void fraction predictive method based on the minimum kinetic energy. *J. Brazilian Soc. Mech. Sci. Eng.* 38, 209–225. <https://doi.org/10.1007/s40430-015-0446-x>
- Khosravi, A., Koury, R.N.N., Machado, L., 2018. Thermo-economic analysis and sizing of the components of an ejector expansion refrigeration system. *Int. J. Refrig.* 86, 463–479. <https://doi.org/10.1016/j.ijrefrig.2017.11.007>
- Khosravi, A., Malekan, M., Assad, M.E.H., 2019. Numerical analysis of magnetic field effects on the heat transfer enhancement in ferrofluids for a parabolic trough solar collector. *Renew. Energy* 134, 54–63. <https://doi.org/10.1016/j.renene.2018.11.015>
- Lee, Y., Jung, D., 2012. A brief performance comparison of R1234yf and R134a in a bench tester for automobile applications. *Appl. Therm. Eng.* 35, 240–242. <https://doi.org/10.1016/j.applthermaleng.2011.09.004>
- Li, H.H., Ji, H., Huang, Z., Wang, B., Li, H.H., Wu, G., 2016. A New Void Fraction Measurement Method for Gas-Liquid Two-Phase Flow in Small Channels. *Sensors* 16, 159. <https://doi.org/10.3390/s16020159>
- Li, H.H., Zheng, X., Ji, H., Huang, Z., Wang, B., Li, H.H., 2017. Void fraction measurement of bubble and slug flow in a small channel using the multivision technique. *Particuology* 33, 11–16. <https://doi.org/10.1016/j.partic.2016.11.004>



- Li, M., Dang, C., Hihara, E., 2012. Flow boiling heat transfer of HFO1234yf and R32 refrigerant mixtures in a smooth horizontal tube: Part I. Experimental investigation. *Int. J. Heat Mass Transf.* 55, 3437–3446. <https://doi.org/10.1016/j.ijheatmasstransfer.2012.03.002>
- Lu, M.C., Tong, J.R., Wang, C.C., 2013. Investigation of the two-phase convective boiling of HFO-1234yf in a 3.9 mm diameter tube. *Int. J. Heat Mass Transf.* 65, 545–551. <https://doi.org/10.1016/j.ijheatmasstransfer.2013.06.004>
- Mastrullo, R., Mauro, A.W., Thome, J.R., Vanoli, G.P., Viscito, L., 2016. Critical heat flux: Performance of R1234yf, R1234ze and R134a in an aluminum multi-minichannel heat sink at high saturation temperatures. *Int. J. Therm. Sci.* 106, 1–17. <https://doi.org/10.1016/j.ijthermalsci.2016.03.011>
- Mastrullo, R., Mauro, A.W., Viscito, L., 2017. Experimental CHF for low-GWP fluids and R134a. Effect of the Lh/D ratio at low and high mass velocities. *Int. J. Heat Mass Transf.* 109, 1200–1216. <https://doi.org/10.1016/j.ijheatmasstransfer.2017.02.071>
- Moffat, R.J., 1988. Describing the uncertainties in experimental results. *Exp. Therm. Fluid Sci.* 1, 3–17. [https://doi.org/10.1016/0894-1777\(88\)90043-X](https://doi.org/10.1016/0894-1777(88)90043-X)
- Mortada, S., Zoughaib, A., Arzano-Daurelle, C., Clodic, D., 2012. Boiling heat transfer and pressure drop of R-134a and R-1234yf in minichannels for low mass fluxes. *Int. J. Refrig.* 35, 962–973. <https://doi.org/10.1016/j.ijrefrig.2012.03.004>
- Nawaz, K., Shen, B.B., Elatar, A., Baxter, V., Abdelaziz, O., 2017. R1234yf and R1234ze(E) as low-GWP refrigerants for residential heat pump water heaters. *Int. J. Refrig.* 82, 348–365. <https://doi.org/10.1016/j.ijrefrig.2017.06.031>
- Padilla, M., Revellin, R., Haberschill, P., Bensafi, A., Bonjour, J., 2011. Flow regimes and two-phase pressure gradient in horizontal straight tubes: Experimental results for HFO-1234yf, R-134a and R-410A. *Exp. Therm. Fluid Sci.* 35, 1113–1126. <https://doi.org/10.1016/j.expthermflusci.2011.03.006>
- Paranjape, S., Ritchey, S.N., Garimella, S. V., 2012. Electrical impedance-based void fraction measurement and flow regime identification in microchannel flows under adiabatic conditions. *Int. J. Multiph. Flow* 42, 175–183. <https://doi.org/10.1016/j.ijmultiphaseflow.2012.02.010>
- Qi, Z., 2015. Performance improvement potentials of R1234yf mobile air conditioning system. *Int. J. Refrig.* 58, 35–40. <https://doi.org/10.1016/j.ijrefrig.2015.03.019>
- Qi, Z., 2013. Experimental study on evaporator performance in mobile air conditioning system using HFO-1234yf as working fluid. *Appl. Therm. Eng.* 53, 124–130. <https://doi.org/10.1016/j.applthermaleng.2013.01.019>
- Qian, H., Hrnjak, P., 2019. Void Fraction Measurement and Flow Regimes Visualization of R134a in Horizontal and Vertical ID 7 mm Circular Tubes. *Int. J. Refrig.* <https://doi.org/10.1016/J.IJREFRIG.2019.04.018>
- Revellin, R., Lips, S., Neveu, P., Bonjour, J., 2012. A comprehensive non-equilibrium thermodynamic analysis applied to a vapor–liquid two-phase flow of a pure fluid. *Int. J. Multiph. Flow* 42, 184–193. <https://doi.org/10.1016/j.ijmultiphaseflow.2012.02.008>
- Rocha, M.S., Simões-Moreira, J.R., 2008. Void Fraction Measurement and Signal Analysis from Multiple-Electrode Impedance Sensors. *Heat Transf. Eng.* 29, 924–935.

<https://doi.org/10.1080/01457630802186015>

- Rouhani, S., Axelsson, E., 1970. Calculation of void volume fraction in the subcooled and quality boiling regions. *Int. J. Heat Mass Transf.* 13, 383–393. [https://doi.org/10.1016/0017-9310\(70\)90114-6](https://doi.org/10.1016/0017-9310(70)90114-6)
- Saitoh, S., Dang, C., Nakamura, Y., Hihara, E., 2011. Boiling heat transfer of HFO-1234yf flowing in a smooth small-diameter horizontal tube. *Int. J. Refrig.* 34, 1846–1853. <https://doi.org/10.1016/j.ijrefrig.2011.05.018>
- Sánchez, D., Cabello, R., Llopis, R., Arauzo, I., Catalán-Gil, J., Torrella, E., 2017. Energy performance evaluation of R1234yf, R1234ze(E), R600a, R290 and R152a as low-GWP R134a alternatives. *Int. J. Refrig.* 74, 267–280. <https://doi.org/10.1016/j.ijrefrig.2016.09.020>
- Schabowicz, K., 2014. Ultrasonic tomography – The latest nondestructive technique for testing concrete members – Description, test methodology, application example. *Arch. Civ. Mech. Eng.* 14, 295–303. <https://doi.org/10.1016/j.acme.2013.10.006>
- Sempértegui-Tapia, D.F.D.F., Ribatski, G., 2017. Flow boiling heat transfer of R134a and low GWP refrigerants in a horizontal micro-scale channel. *Int. J. Heat Mass Transf.* 108, 2417–2432. <https://doi.org/10.1016/j.ijheatmasstransfer.2017.01.036>
- Sujumong, M., 1997. Heat transfer, pressure drop and void fraction in two-phase, two component flow in a vertical tube. University of Manitoba.
- Taylor, B.N., 1994. Guidelines for evaluating and expressing the uncertainty of NIST measurement results. Gaithersburg, MD. <https://doi.org/10.6028/NIST.TN.1297>
- Thompson, M., 2013. Advancing ozone and climate protection Technologies: next steps, in: Policy and Technology Challenges with HFC Regulation – Second International Conference. Bangkok, Thailand.
- Tompkins, C., Prasser, H.-M., Corradini, M., 2018. Wire-mesh sensors: A review of methods and uncertainty in multiphase flows relative to other measurement techniques. *Nucl. Eng. Des.* 337, 205–220. <https://doi.org/10.1016/j.nucengdes.2018.06.005>
- Wang, L., Dang, C., Hihara, E., 2012. Experimental study on condensation heat transfer and pressure drop of low GWP refrigerant HFO1234yf in a horizontal tube. *Int. J. Refrig.* 35, 1418–1429.
- Wojtan, L., Ursenbacher, T., Thome, J.R., 2005. Measurement of dynamic void fractions in stratified types of flow. *Exp. Therm. Fluid Sci.* 29, 383–392. <https://doi.org/10.1016/J.EXPTHERMFLUSCI.2004.05.017>
- Woldesemayat, M.A., Ghajar, A.J., 2007. Comparison of void fraction correlations for different flow patterns in horizontal and upward inclined pipes. *Int. J. Multiph. Flow* 33, 347–370. <https://doi.org/10.1016/j.ijmultiphaseflow.2006.09.004>
- Zivi, S.M., 1964. Estimation of Steady-State Steam Void-Fraction by Means of the Principle of Minimum Entropy Production. *J. Heat Transfer* 86, 247. <https://doi.org/10.1115/1.3687113>