



**HAL**  
open science

# Experimental and numerical modelling of hygrothermal transfer: Application on building energy performance

Fouad Boukhelf, Abdelkrim Trabelsi, Rafik Belarbi, Mohamed Bachir  
Bouiadjra

## ► To cite this version:

Fouad Boukhelf, Abdelkrim Trabelsi, Rafik Belarbi, Mohamed Bachir Bouiadjra. Experimental and numerical modelling of hygrothermal transfer: Application on building energy performance. *Energy and Buildings*, 2022, 254, pp.111633. 10.1016/j.enbuild.2021.111633 . hal-03418106

**HAL Id: hal-03418106**

**<https://hal.science/hal-03418106v1>**

Submitted on 5 Jan 2024

**HAL** is a multi-disciplinary open access archive for the deposit and dissemination of scientific research documents, whether they are published or not. The documents may come from teaching and research institutions in France or abroad, or from public or private research centers.

L'archive ouverte pluridisciplinaire **HAL**, est destinée au dépôt et à la diffusion de documents scientifiques de niveau recherche, publiés ou non, émanant des établissements d'enseignement et de recherche français ou étrangers, des laboratoires publics ou privés.



Distributed under a Creative Commons Attribution - NonCommercial 4.0 International License



## Nomenclature

Term	Signification	Unit
$C_m$	Hydric capacity	(-)
$C_p$	Heat capacity	$J.K^{-1}.kg^{-1}$
$C_{p\ dry}$	Heat capacity of dry material	$J.K^{-1}.kg^{-1}$
$C_{p\ water}$	Heat capacity of water	$J.K^{-1}.kg^{-1}$
$D_w$	Hydric diffusivity	$m^2.s^{-1}$
$h_l$	Mass enthalpy of liquid water	$J.kg^{-1}$
$h_v$	Mass enthalpy of vapor water	$J.kg^{-1}$
$J_l$	Liquid flow density	$kg.m^{-2}.s^{-1}$
$J_q$	Heat flux density	$W.m^{-2}$
$J_v$	Vapor flow density	$kg.m^{-2}.s^{-1}$
$k_l$	water liquid permeability	$kg.Pa^{-1}.m^{-1}.s^{-1}$
$K_{PP}$	Moisture transfer coefficient	$kg.Pa^{-1}.m^{-1}.s^{-1}$
$K_{PT}$	Moisture transfer coefficient associated with heat transfer	$J.s.m^{-3}.K^{-1}$
$K_{TP}$	Heat transfer coefficient associated with moisture transfer	$W.kg^{-1}$
$K_{TT}$	Heat transfer coefficient	$W.m^{-1}.K^{-1}$
$\lambda_{dry}$	Thermal conductivity of dry material	$W.m^{-1}.K^{-1}$
$\lambda_{water}$	Thermal conductivity of water	$W.m^{-1}.K^{-1}$
$ln$	Logarithm	
$L_v$	Latent heat of vaporization	$J.kg^{-1}$
$LWL$	Long wavelength radiation	$W.m^{-2}$
$M$	Molar mass	$kg.mol^{-1}$
$ME$	Mean error	
$P_c$	capillary pressure	Pa
$P_v$	Vapor pression	Pa
$P_{v,sat}$	Saturation vapor pressure	Pa
$R$	Perfect gas constant	$J.mol^{-1}.K^{-1}$
$R^2$	R squared	(-)
$RH$	Relative humidity	(%)
$RMSE$	Root Mean Square Error	
$\sigma$	Ratio of vapor flow to hydric flow	(-)
$SWL$	Short wavelength radiation	$W.m^{-2}$
$T$	Temperature	K
$t$	Time	s
$w$	Water content	$kg.m^{-3}$
$u$	Water content	$kg.kg^{-1}$
$\delta_p$	Water vapor permeability	$kg.Pa^{-1}.m^{-1}.s^{-1}$
$\lambda$	Thermal conductivity	$W.m^{-1}.K^{-1}$
$\rho_l$	density of water in liquid state	$kg.m^{-3}$
$\rho_s$	dry density of material	$kg.m^{-3}$
$S$	Sensitivity	%

$Y$	Model's variable (T or Pv)
$p$	Model's parameter
$\delta$	Variation range

27 **Highlights**

- 28 • Heat and mass transfer characteristics are studied experimentally and numerically.
- 29 • Real climatic conditions as solar radiation and rainfall are selected for the study of building
- 30 envelope elements at wall scale.
- 31 • An eco-concrete wall with a replacement of cement by 20% of glass powder is tested.
- 32 • A new experimental set-up was designed which can generate solar radiations and rainfall.
- 33 • Sensitivity analysis of heat and moisture transfer model was performed.

34 **1 Introduction**

35 **1.1 Background**

36 The environmental impact of buildings makes the energy efficiency of buildings a crucial challenge  
37 for designers and engineers in order to minimize their energy bill and CO<sub>2</sub> emissions. This requires an  
38 accurate prediction of the thermal losses of building envelopes. Moreover, moisture is an important  
39 factor since it has an impact on the performance through latent heat exchange, and is strongly coupled  
40 with thermal transfer. In this context, several models have been proposed in the literature to predict the  
41 physical phenomena of hygrothermal transfer in porous materials. Among others, the building  
42 envelope is exposed to the various dynamic influences and conditions of the external environment  
43 (radiation, rain, temperature, wind...) as well as those of the internal environment (heating, ventilation,  
44 different sources of heat and humidity...). Under all these conditions, the envelope is subject to  
45 complex heat and mass transfer phenomena. The Executive Committee of the International Agency for  
46 Energy in Buildings and Community Systems has initiated in 2003 the Annex 41 [1] "Whole Building  
47 Heat, Air, and Moisture Response". In this annex, experimental campaigns of coupled heat, mass and  
48 air transfers in the building envelope were conducted in order to compare the results with those of the  
49 predictions of twelve numerical tools for the simulation of transfers at the building envelope scale. The  
50 main objective was to fortify and verify the reliability of these prediction tools by comparing them  
51 with experimental results [2,3]. The experiments were carried out in scale 1 test cells. The principle of  
52 each experiment was to measure the influence of the materials on the hygroscopic buffering capacity  
53 of the interior facings of each cell. The results obtained showed a very good correlation between the  
54 measured and calculated relative interior humidities in the case of a non-hygroscopic interior facing. In  
55 contrast, the 12 models tested had more difficulty simulating the indoor relative humidity in the case  
56 of a hygroscopic interior facing [4].

57 Numerical modeling and simulation is a useful method for studying or designing building envelopes.  
58 The modeling of coupled heat and mass transfers in envelopes is based on several phenomenological

59 approaches which differ principally in the transfer potentials used. For heat transfer, temperature is  
60 referred to as a conventional transfer potential. For humidity transfer, on the other hand, there is no  
61 unanimity. There are several models with different moisture transfer driving forces as water content  
62 [5], vapor pressure [6,7], vapor content [8,9] and relative humidity [10,11].

63 Luikov [12] was one of the pioneers in proposing a model taking into account heat and mass coupling  
64 transfers in porous materials. This model considers that water vapor diffusion depends on the mass  
65 water content gradient ( $u$ ) and temperature ( $T$ ) on the one hand, and on the total pressure gradient ( $P$ )  
66 inside the porous material on the other hand [13]. However, it suggests separating the vapor and liquid  
67 flows. This model has been refined in many research studies [14,15]. The major difficulty of this  
68 model lies in the determination of the model parameters by separating the transfer of the liquid and  
69 vapor phase and in the determination of the thermal gradient coefficient. An experimental bench has  
70 been proposed for this purpose in the research studies by Trabelsi et al. [13] to evaluate this  
71 coefficient.

72 Accordingly, the IEA-Annex 24 [16] was reported the modeling of six tools handling heat, air and  
73 moisture. In the work of Grunewald et al [17], the convective flows as heat and moisture vectors in  
74 porous materials to diffusion were added explicitly. Janssens et al [18] proposed a two dimensional  
75 model that predicted the heat, air, moisture response of building roofs. Ten Wolde et al [19] and Hens  
76 et al [20] enhanced the diffusion method by adding the air coupled to enthalpy and vapor transport.

77 Experimental study of the hygrothermal behavior of building walls at the intermediate scale is the  
78 subject of several research works in the literature, which deal with comparison of the results predicted  
79 by mathematical models and experimental results. Rahim et al. [21] developed an experimental set-up  
80 presented in a climatic chamber with temperature and humidity regulated to simulate the external  
81 environment. In addition, one of its sides was closed by the wall under study. Humidity and  
82 temperature sensors were incorporated in the wall, making it possible to monitor the evolution of the  
83 temperature and humidity. Analysis of the hygrothermal behavior of a 1:1 scale wall subjected to static  
84 and dynamic environmental conditions in terms of temperature and humidity was undertaken. The  
85 numerical simulation showed the need to take into account the heterogeneity of the material, the  
86 influence of temperature as well as the hysteresis phenomenon on the sorption curves on mass transfer.  
87 In addition, Moradias et al. [22] investigated experimentally the hygrothermal behavior of renovated  
88 stone masonry walls of old buildings, using a climate chamber in which temperature and humidity  
89 variations that occur in a stone masonry wall were measured. The results obtained in the laboratory  
90 were compared with the analytical results of the Glaser method obtained using dedicated software for  
91 the evaluation of the probability of occurrence of internal condensation in walls. Besides, Ferroukhi et  
92 al. [23] developed an experimental set-up consisting of two chambers with controlled humidity and  
93 temperature simulating the outdoor climate and the building atmosphere. The climate of the two

94 chambers was provided by temperature and humidity generators. Sensors were installed at different  
95 positions in the two chambers and in the studied wall.

96 Slimani et al. [8] also presented an experimental bench with two humidity and temperature controlled  
97 chambers. Extensive instrumentation was installed for the measurement of water and heat flows, as  
98 well as the temperature and humidity at the wall profile, and in both environments the measurement of  
99 air speed and the pressure difference between the two environments. The objective of this set-up was  
100 to study and analyze the hygrothermal behavior in the walls of the building envelope, to validate HAM  
101 models, or to characterize, at the scale of the wall, the transfer properties.

102 More recently, Tejeda et al. [24] designed a hot box in order to evaluate the hygrothermal behavior of  
103 the sample. This latter was calibrated using a reference sample of extruded polystyrene plate to  
104 quantify the heat gains through its envelope. The solid block wall sample was evaluated in three  
105 configurations (simple wall, wall with a mortar coat and a wall with a mortar coat on both sides).  
106 Simultaneously, three empirical models were obtained to determine the global heat transfer coefficient  
107 related with temperature and vapour pressure. In addition, Congedo et al. [25] highlighted the study of  
108 rising damp which is considered as one of the most widespread and damaging deterioration processes  
109 for buildings and architectural and cultural heritage. In this work, the dynamic assessment of rising  
110 damp is established on two types of building stones widely used in Italy, namely the stone of Lecce  
111 and Carparopar a following of the weight of the wet samples and the height of the humidity rise. At  
112 the end of the experimental campaign, the behavior of the water romentation was predicted using the  
113 theoretical model. Also, Hamdaoui et al. [26] has established a comprehensive state of the art of  
114 physical and data-driven models of building hygrothermal behavior. This study highlights the need for  
115 a recognized method for hygrothermal simulations of hygroscopic envelopes. It provides a better  
116 understanding of hygrothermal simulation, which helps in selecting the most appropriate tool or  
117 model.

118 To our knowledge , rain is rarely used in hygrothermal transfers modeling. In the studies of Kunzel  
119 [27] and Rouchier et al. [28], rain infiltration was added through a liquid water flow. Moreover, in the  
120 work of Janssen [29] they also modeled driving rain on a building wall. The mass balance on the  
121 external surface is constituted by rain water and vapor exchange. The boundary conditions used are  
122 flow conditions. As long as the exposed external facade does not reach capillary saturation, there is  
123 moisture exchange with the atmosphere gas, including rain driven with wind and water vapor.

124 Wind-driven rain can be retained as a function of the coefficient of interaction between the wind, rain  
125 and wall, and this coefficient depends on the wind speed and its direction from the wall with respect to  
126 North, the amount of horizontal rain, and the orientation of the wall with respect to North [30]. In  
127 work carried out by Ihara et al., [31], an experimental bench (Atlas SC 600 MHG Solar Simulator,  
128 Vötsch Industrietechnik GmbH, Germany) simulating solar radiation and moisture variation is used

129 with the aim of investigating the application of aerogel in the building and construction sector and thus  
130 its durability. This work focused on the aging effect of aerogel granules, with emphasis on two aging  
131 factors, humidity and solar radiation. In addition, previous numerical studies also consider runoff from  
132 exterior building facades [32,33], furthermore ASHRAE Project 1235 confirmed that wet capillary  
133 exterior finishes, such as brick veneers, induce solar-induced vapor flow with moisture deposition in  
134 the interior layers of thermal insulation [34].

135 Generally, the construction materials are characterized according to recommendations relating to  
136 standards at the material scale. These properties, which also have input parameters to build numerical  
137 simulation models, are nevertheless insufficient to take into account the hygrothermal behavior of a  
138 1:1 scale wall of a building because of its heterogeneity and the influence of variable environmental  
139 conditions. Experimental validation is necessary at an intermediate scale to provide more  
140 representative information with better control of boundary conditions.

141 Solar radiation is in the short wavelength between 300 and 3,000 nm. The solar radiation flux at the  
142 external surface is given in several research works [35–37]. It is the combination of the absorbed short  
143 wavelength solar energy and the long wavelength radiation exchanged with the surface, sky and  
144 multiple adjacent walls and surfaces.

145 Currently, there is little work dealing with experimental work of mass and heat transfer taking into  
146 account solar radiation and rainfall. The interest in taking these parameters into account is to qualify  
147 the facades and predict the service life of constructions [38]. Recently, researchers have studied the  
148 effect of rain or solar radiation at the building level to qualify the quality of façade cladding based on  
149 fibrous materials [39], by using Wufi ® to evaluate the influence of the placement of interior or  
150 exterior thermal insulation layers on the hygrothermal behavior of the envelope element [40] and  
151 experimental study to evaluate the hygrothermal performance assessment of wood frame wall systems  
152 [41]. These studies were carried out on site under real climatic conditions, which had the advantage of  
153 studying the envelope in operation. Nevertheless, under these conditions the analysis of the transfer  
154 mechanisms becomes difficult and it is mainly for this reason that the development of an experimental  
155 bench under controlled laboratory conditions was chosen. This allows, among other reasons, the  
156 simulation of loading sequences, which facilitates the analysis of hygrothermal transfer mechanisms.  
157 The studies of Rahim et al. [21], Ferroukhi et al. [23], Slimani et al. [8] and Rafidiarison et al. [42]  
158 have developed experimental benches under controlled laboratory conditions but these do not allow  
159 for the effects of solar radiation/rainfall to be considered.

## 160 **1.2. Aim of the study**

161 Following the literature state of art existing, the taking into account of solar radiation and a rainfall in  
162 the hygrothermal behavior study is little mentioned and needs further studies [43]. For this purpose,

163 the following methodology was established and summarized in Fig. 1. Firstly, a mathematical model  
164 for the prediction of the hygrothermal transfer was proposed and a new set-up was designed. This  
165 latter is composed of two chambers controlled in solar radiation, temperature and water spray, the first  
166 simulating the external environment and the second simulating the habitable environment. The  
167 advantages of this set-up are that it takes into account the different climatic conditions, in particular  
168 solar radiation, rainfall and changes in temperature and humidity.

169 Secondary, with the goal to address the requirements of the RE2020 environmental regulation [44] in  
170 terms of greenhouse gas emission reduction and sustainable construction in the building sector, we  
171 have been interested to the use of solid waste glass as partial replacement of cement. To be precise, the  
172 glass powder incorporated in concrete is both beneficial to environmental protection and economic  
173 development. In this work, an investigation on eco-concretes is established on the wall scale,  
174 evaluating the hygrothermal behavior of this material for an application in building envelope elements.  
175 Physical principals has been confirmed by the experimental bench implemented.

176 Subsequently, two scenarios of hygrothermal conditions were programmed in order to validate the  
177 prediction model. The first consists of varying the temperature sinusoidally over a period of 24 hours a  
178 day for 7 days without solar radiation or rain. The second retains the same temperature variation but is  
179 accompanied by solar radiation and rainfall applied alternately for periods of 1 hour intervals.  
180 Moreover, the chemical resistance is established through the chemical analysis of the water used to  
181 simulate rainfall before and after the rain sequences. The quantities of released chemical species from  
182 the wall are evaluated which will inform us about the sustainability of the eco-concrete regarding  
183 chemical degradation. This first step allowed us to plan a further study in which the chemical  
184 composition through the thickness of the wall will be studied using destructive methods.

185 Finally, a sensitivity analysis is performed on the developed hygrothermal model, while it is applied to  
186 a glass powder-based eco-concrete. In this part, the influence of a wide range of parameters of order  
187 20% on the specific heat, thermal conductivity, density, water vapor/liquid permeability and sorption  
188 isotherm is explored. A local sensitivity analysis method is used to separately capture the influence of  
189 each parameter on the model result.



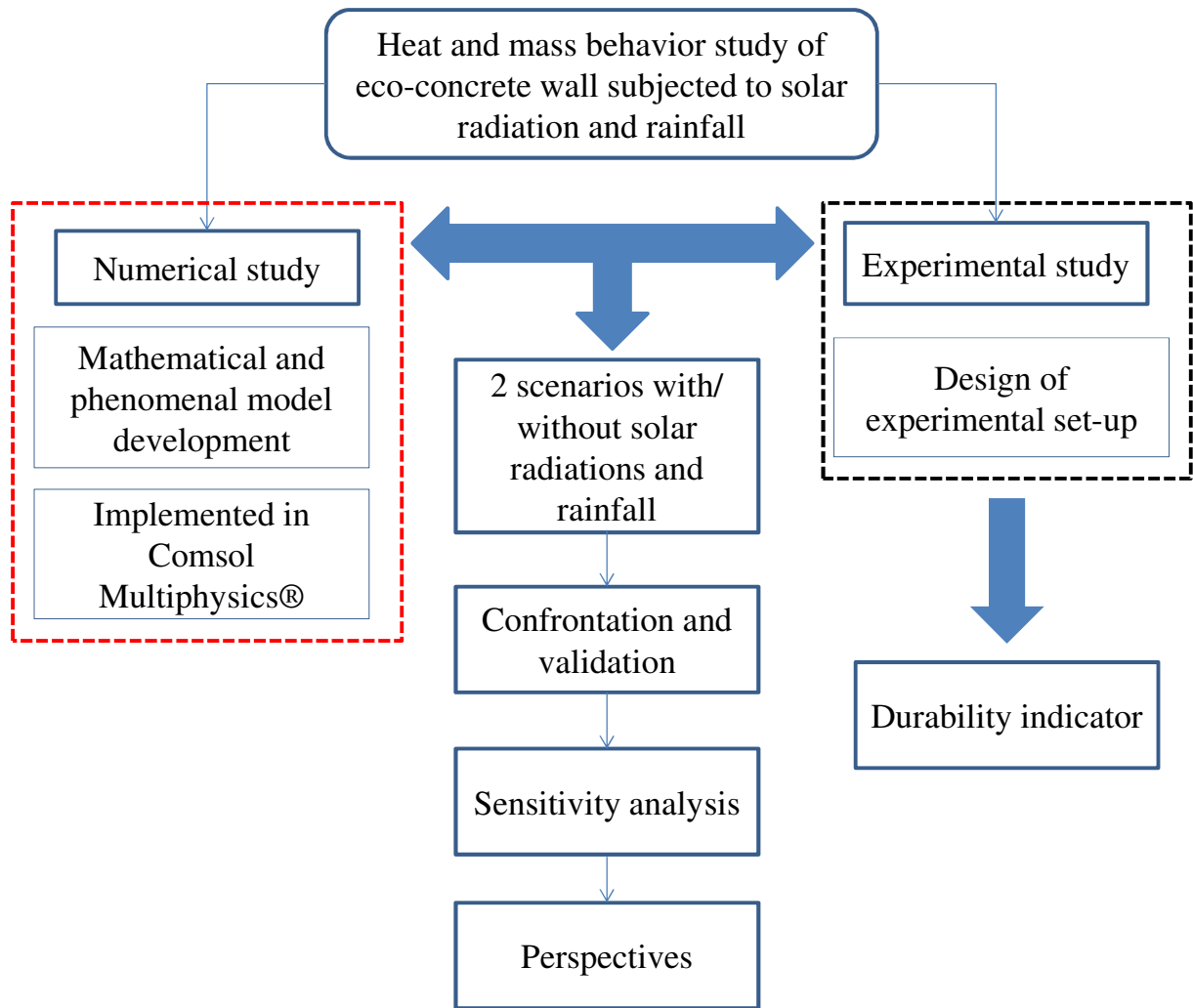

190

191

Fig. 2: Outline of the approach undertaken.

192 **2 Experimental set-up**

193 To study the effect of wetting/drying by rainfall/solar radiation on the hygrothermal behavior at the  
 194 scale of the building wall, a new experimental bench was developed as shown in Fig. 2. It is composed  
 195 of two cubic chambers with sides of of 1.25 m length and made of 10 mm thick plywood panels with 5  
 196 cm of extruded polystyrene insulation on the inside. The water barrier is provided by PVC panels.

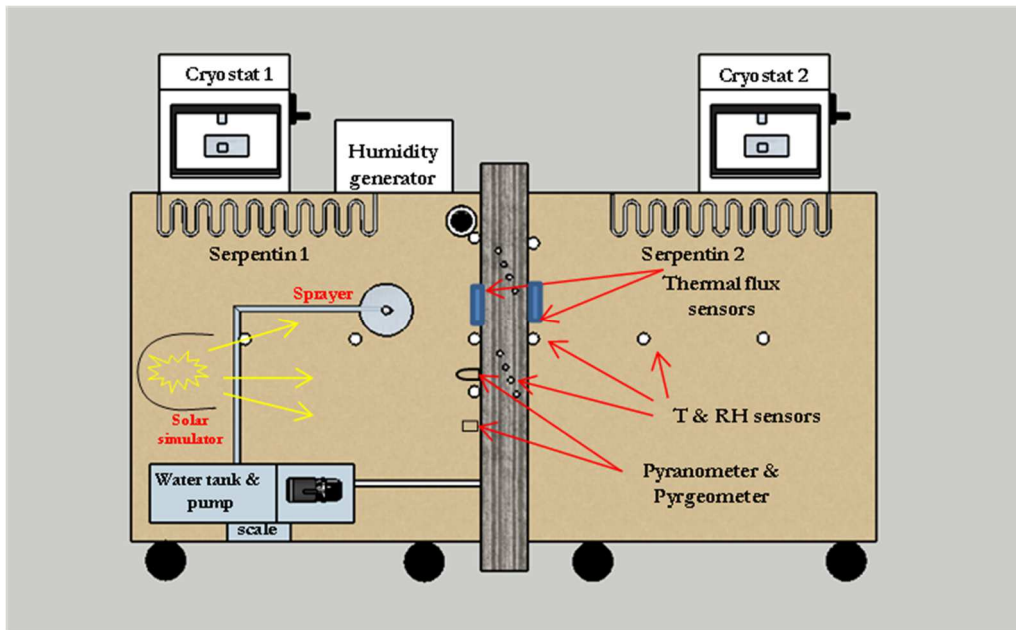

197

198

Fig. 2: Experimental bench.

199 **2.1 Wall installation**

200 The studied monolayer wall, with dimensions 1.30 m x 1.35 m x 0.11 m, is shown in Fig. 3. It is made  
 201 of an eco-concrete with a 20% substitution of cement by glass powder. The wall was built by pouring  
 202 the eco-concrete in three layers given the large quantity of concrete in an environment of laboratory at  
 203 22°C and 60% relative humidity. A concrete vibrator was used to eliminate the effect of segregation  
 204 and homogenize all the proprieties. The wall was then demolded after 24 hours of curing and  
 205 conditioned in the same climate as the previous one as shown in Fig. 3. After demolding, we obtained  
 206 a homogeneous, smooth and less segregated surface due to the fresh vibration.

207 Once the formwork has been demolded, the sample requires four steps before starting the tests:

- 208 • Installation of the vapor barrier made from aluminum adhesive tape and rock wool on the  
 209 lateral borders of the wall (air and moisture barrier and thermal insulation to minimize edge  
 210 effects);
- 211 • Drilling of the wall at several depths from one side of the wall sample at 4, 6 and 9 cm;
- 212 • Inserting the sensors into the wall and then sealing the contours of the cable passages in the  
 213 wall using silicone and polyethylene well wrapped with adhesive tape;
- 214 • Installation of the experimental bench and pre-conditioning of the wall. The air tightness  
 215 between wall and bench was ensured by clamping.

216

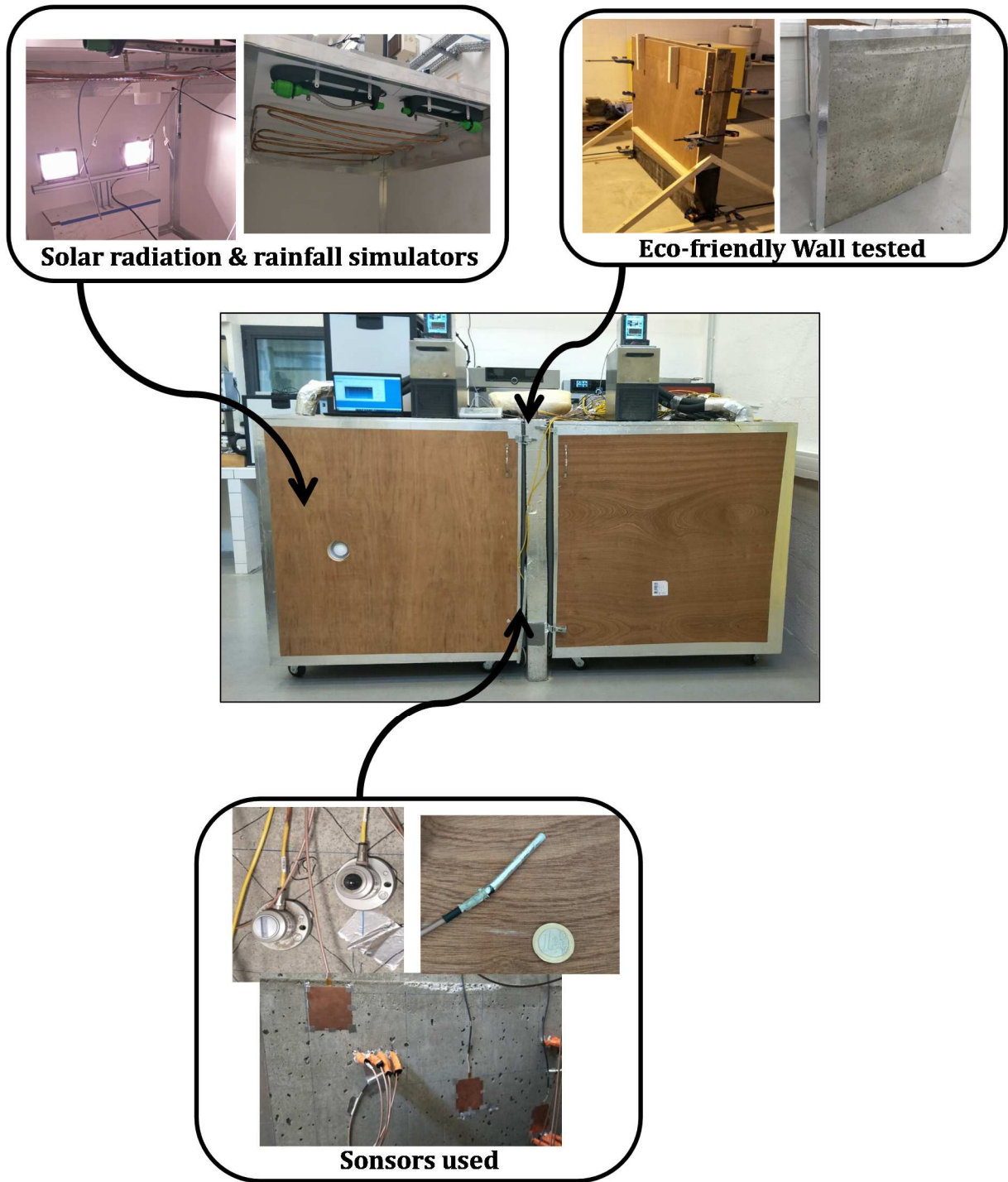

217

218

Fig. 3: Bench developed.

219 **2.2 Temperature regulation**

220 Both chambers are temperature-controlled by a temperature bath (Huber temperature baths type CC-  
 221 K6) with heating and cooling capacities of 2 kW and 0.15 kW respectively. The two temperature baths  
 222 are connected to a 20m long serpentine pipe, which is installed inside the casing on the upper side to  
 223 act as a heat exchanger. A fans are installed to circulate the air inside the both boxes. The boxes are  
 224 equipped with sensors to regulate and control the temperature. The first box is also equipped with a  
 225 sprinkler connected to a timer simulating rain and a spotlight simulating solar radiation. The second

226 chamber simulates the habitable environment. The wall is placed between the two chambers. The wall  
227 has humidity and temperature sensors located on the exterior and interior surfaces and through the  
228 wall as shown in Fig. 3, and temperature sensors are placed in both chambers at various heights to  
229 check the boundary conditions.

### 230 **2.3 Rainfall simulation**

231 A spraying system is adopted to simulate precipitation. It consists of two sprinklers connected to a  
232 pump with a flow rate of 50 l/h which corresponds to a precipitation rate of 50 mm/m<sup>2</sup>h. The  
233 precipitation rate was determined by a simple conversion of the flow rate provided by the pump  
234 divided by a surface which is equivalent to 1m<sup>2</sup> subjected to humidification by the injected water. In  
235 fact, this water spray rate is intended to apply uniform and consistent water to the surface of the wall  
236 sample, and does not correspond to the amount of wind-driven rain on actual building facades. The  
237 pump is immersed in a sealed tank and placed on a Kern® DS 16K0.1 scale with a capacity of 16 kg  
238 and a precision of 0.1 g. The latter is connected with a computer for acquisition using Simple Data  
239 Logger (SDL) software. The system's power supply is controlled by a timer to regulate the time and  
240 rain duration. The purpose of using the scale is to be able to measure the amount of rain absorption by  
241 the wall and it corresponds to the rain flow infiltrated by the wind driving rain [32,33].

### 242 **2.4 Solar radiation simulation**

243 Two Langlois® sun simulators with an electrical power of 500 W each are used to simulate solar  
244 radiation. They are installed facing the wall at 60 cm distance, on the same height of 50 cm with an  
245 interspace of 45 cm. The facility is connected to an electrical power variator that allows the intensity  
246 of light to be varied to simulate solar irradiance ranging from 0 to 1000 W/m<sup>2</sup> (winter and summer  
247 periods). Solar lamps emit in both short and long wavelength radiation (SWL and LWL). Kipp &  
248 Zonen® pyranometers and pyrgeometers are installed to measure irradiance in both ranges. These  
249 measurements are acquired via an ALMEMO data acquisition system from Ahlborn.

250 Radiation of the lamp propagate and fall on all the walls of the chamber directly or by reflection.  
251 The homogeneity of the illuminance on the studied wall, in both short and long wavelength has been  
252 evaluated (see Fig. 4). The surface map was obtained by installing the pyranometer and pyrgeometer  
253 on the surface of the wall at different position following a 5X5 grid. the configuration of the  
254 installation generates illuminance heterogeneity, especially for SWL radiation. The central part which  
255 is our area of interest shows an acceptable homogeneity.

256

257

258

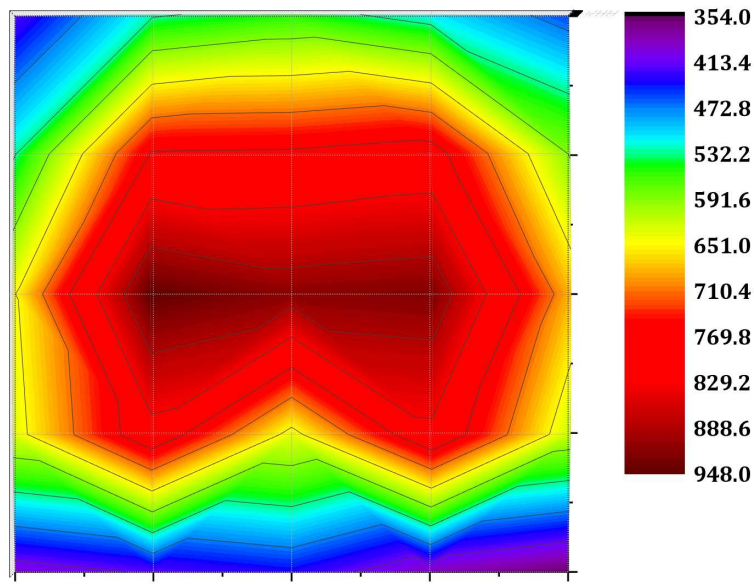

Short Wavelength Radiation SWL(W/m<sup>2</sup>)

259

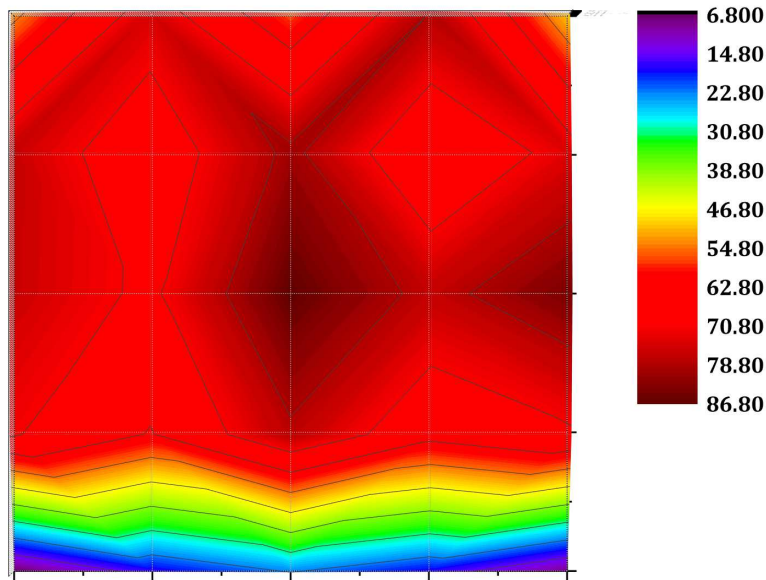

Long Wavelength Radiation LWL (W/m<sup>2</sup>)

260

261

Fig. 4: short and long wavelength radiation distribution on the studied wall

262 **2.5 Further sensors and associated acquisition**

263 The temperature and RH sensors (Ahlborn FHA 646 R) used are thermistor type for T and capacitive  
 264 type for RH. The advantage of these sensors is their small size and measurement accuracy. They allow  
 265 the measurement of T and RH in both chambers, at different positions throughout the wall and at the  
 266 external and internal borders of the wall as shown in Fig. 5. Temperature and relative humidity sensors  
 267 are placed at 4, 6 and 9 cm and at the external and internal borders. They are installed in depth in 3  
 268 different zones. All sensors were pre-calibrated by the manufacturer. They are connected to the  
 269 ALMEMO data acquisition system. The central station records the data every minute. The  
 270 characteristics of the sensors are presented in Table 1.

271

Table 1. The technical data of the hygrothermal and thermal flux sensors

Technical data	
RH accuracy	$\pm 5 \%$
T accuracy	0.3 °C
Maximum response time	10 s
RH measurement range	0 – 100 % RH
T measurement range	- 20 – 100 °C
Thermal flux sensitivity	60 $\mu\text{V}/(\text{W}\cdot\text{m}^2)$
Thermal flux range	$\pm 1500 \text{ W}\cdot\text{m}^{-2}$
Thermal flux accuracy	5%

272 The thermal flow meters were calibrated by the manufacturer and are diagonally placed on both  
 273 borders of the wall to measure the heat flow and connected to a Campbell Scientific datalogger. The  
 274 frequency of measurement is the same as the temperature and relative humidity acquisition.

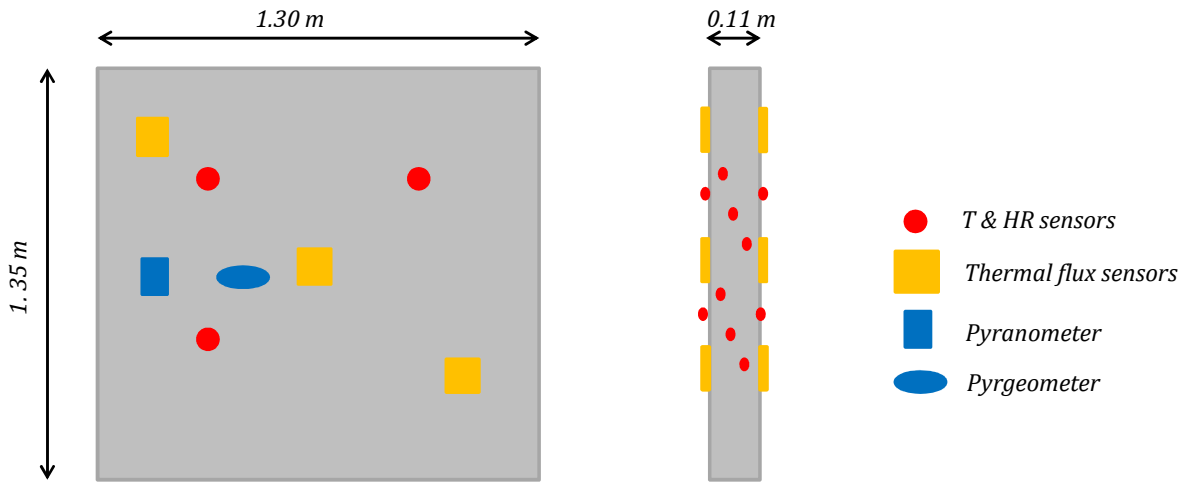

275

276 Fig. 5: Sensor position on the wall borders and in the interior of the wall (left external border, right  
 277 cross-sectional view)

278 **3 Mathematical model of mass and heat transfer in porous media**

279 The development of macroscopic models of coupled heat and moisture transfer to predict the behavior  
 280 of porous materials has been of interest to several researchers. In this section, a mathematical model  
 281 based on the Luikov model [12] is proposed for the prediction of the hygrothermal behavior of  
 282 building walls exposed to rain. The model developed takes the temperature and vapor pressure as  
 283 transfer potentials. All these input parameters (thermal conductivity  $\lambda$ , specific heat  $C_p$ , density  $\rho$ ,  
 284 sorption isotherm  $C_m$  and water vapor and liquid permeabilities  $\delta_p$  and  $k_l$ ) are obtained from existing

285 research [45]. The water diffusivity  $D_w$  is proposed in the literature and is a function of liquid water  
 286 permeability and water vapor permeability. The measurement campaign carried out is presented in  
 287 Table 2.

### 288 **3.1 Mathematical formulation**

289 Moisture transfer in a porous medium can be divided into the diffusion of water vapor and by a  
 290 capillary effect. Heat transfer is effected by advection conduction [46]. The model developed consists  
 291 of two heat and moisture balance equations and is based on the following assumptions made in order  
 292 to simplify some phenomena:

- 293 • The solid phase is considered homogeneous, isotropic and non-reactive (the hydration of the  
 294 cement matrix is assumed to be complete, therefore the source terms due to chemical reactions  
 295 are neglected);
- 296 • The liquid phase is assumed to be pure water;
- 297 • The gaseous phase, consisting of dry air and water vapor, follows the perfect gas law;
- 298 • Heat transfer by volume radiation is not taken into account, unlike surface radiation;
- 299 • Change of the humidity state from liquid or gaseous to solid or vice versa is not considered in  
 300 this model (freeze/thaw phenomenon);
- 301 • Moisture transfer under the gravitational effect is negligible.

#### 302 **3.1.1 Mass balance**

303 Equation 1 represents the mass conservation equation [27]:

$$304 \quad \frac{\partial w}{\partial t} = -\bar{\nabla} \cdot (-\delta_p \bar{\nabla} P_v - k_l \bar{\nabla} P_c) \quad (1)$$

305 where  $\delta_p$  and  $k_l$  are the water vapor permeability and water liquid permeability respectively.

306 By introducing the isothermal curve into the mass balance equation, the following equations are  
 307 obtained [47]:

$$308 \quad C_m \rho_s \left( \frac{1}{P_{v,sat}(T)} \frac{\partial P_v}{\partial t} + P_v \frac{\partial (1/P_{v,sat}(T))}{\partial t} \right) = -\bar{\nabla} \cdot (-\delta_p \bar{\nabla} P_v - k_l \bar{\nabla} P_c) \quad (2)$$

309 where  $C_m$  is the moisture capacity.

310 Considering the hypothesis of a local thermodynamic equilibrium at the pore level between the two  
 311 phases (vapor and liquid), Kelvin's law as in Eq. (3) is applicable:

$$312 \quad P_c = \frac{\rho_l RT}{M} \ln \left( \frac{P_v}{P_{v,sat}(T)} \right) \quad (3)$$

313 where  $\rho_l$  [kg/m<sup>3</sup>] is the density of water in liquid state, R [J/(mol·K)] is the perfect gas constant, T [K]  
 314 is temperature, and M [kg/mol] is the molar mass.

315 In addition, it is known that the relative humidity (RH) can be described with the following equation:

$$316 \quad RH = \frac{P_v}{P_{v,sat}(T)} \quad (4)$$

317 To determine the capillary pressure gradient, Eq. (3) must be derived to transform the capillary  
 318 pressure gradient into a combination of a water vapor pressure gradient and a temperature gradient,  
 319 which gives:

$$320 \quad \bar{\nabla} P_c = \frac{\rho_l R}{M} \ln \left( \frac{P_v}{P_{v,sat}(T)} \right) \bar{\nabla} T + \frac{\rho_l R T}{M} \frac{\partial \ln \left( \frac{P_v}{P_{v,sat}(T)} \right)}{\partial T} \bar{\nabla} T + \frac{\rho_l R T}{M P_v} \bar{\nabla} P_v \quad (5)$$

321 The mass transfer equation is written as follows:

$$322 \quad \frac{C_m \rho_s}{P_{v,sat}(T)} \frac{\partial P_v}{\partial t} = \bar{\nabla} \cdot \left( K_{PP} \bar{\nabla} P_v + K_{PT} \bar{\nabla} T \right) + \frac{C_m \rho_s P_v}{P_{v,sat}(T)^2} \frac{\partial P_{v,sat}(T)}{\partial T} \frac{\partial T}{\partial t} \quad (6)$$

323 where

$$324 \quad K_{PP} = \left( \delta_p + k_l \frac{\rho_l R T}{M P_v} \right) \quad (7)$$

$$325 \quad K_{PT} = k_l \left( \frac{\rho_l R}{M} \ln \left( \frac{P_v}{P_{v,sat}(T)} \right) + \frac{\rho_l R T}{M} \frac{\partial \ln \left( \frac{P_v}{P_{v,sat}(T)} \right)}{\partial T} \right) \quad (8)$$

### 326 3.1.2 Energy balance

327 Heat transfer in porous wet materials is governed by the energy conservation equation (Eq. 9)  
 328 involving conduction heat transfer in the solid and liquid phases governed by Fourier's law [34],  
 329 convective heat transfer in the liquid and gaseous phases, and liquid-gas phase change [48].

$$330 \quad C_p \rho_s \frac{\partial T}{\partial t} = -\bar{\nabla} \cdot (\bar{j}_q) \quad (9)$$

331 where  $C_p$  is the heat capacity and  $\rho_s$  is the dry density.

332 Heat flow is written as follows [49]:

$$333 \quad \bar{j}_q = -\lambda \bar{\nabla} T + h_l \bar{j}_l + h_v \bar{j}_v \quad (10)$$



334 where  $\lambda$  is the thermal conductivity,  $h_l$  is the mass enthalpy of liquid water (J/kg),  $h_v$  the mass enthalpy  
 335 of water vapor (J/kg),  $j_l$  is the liquid flow density (kg/m<sup>2</sup>.s) and  $j_v$  is the vapor flow density (kg/m<sup>2</sup>.s).

336 The heat transfer equation will be:

$$337 \quad C_p \rho_s \frac{\partial T}{\partial t} = -\bar{\nabla} \cdot \left( -\lambda \bar{\nabla} T - h_l \left( k_l \bar{\nabla} P_c + \delta_p \bar{\nabla} P_v \right) \right) + L_v \sigma C_m \frac{\rho_s}{P_{v,sat}(T)} \frac{\partial P_v}{\partial t} \quad (11)$$

338 where  $L_v$  is the latent heat of vaporization (J/kg) and  $\sigma = \text{div}(j_v) / \text{div}(j_l + j_v)$ .

339 Grouping the values in terms of temperature and vapor pressure will give:

$$340 \quad C_p \rho_s \frac{\partial T}{\partial t} = \bar{\nabla} \cdot \left( K_{TT} \bar{\nabla} T + K_{TP} \bar{\nabla} P_v \right) + L_v \sigma C_m \frac{\rho_s}{P_{v,sat}(T)} \frac{\partial P_v}{\partial t} \quad (12)$$

341 where

$$342 \quad K_{TT} = \left( \lambda + h_l k_l \frac{\rho_l R}{M} \ln \left( \frac{P_v}{P_{v,sat}} \right) + h_l k_l \frac{\rho_l R T}{M} \frac{\partial \ln \left( \frac{P_v}{P_{v,sat}} \right)}{\partial T} \right) \quad (13)$$

$$343 \quad K_{TP} = \left( h_l \delta_p + k_l h_l \frac{\rho_l R T}{M P_v} \right) \quad (14)$$

344 Both the heat and mass transfer equations can be written in condensed form, as follows:

$$345 \quad \rho_s \begin{bmatrix} C_m & 0 \\ 0 & C_p \end{bmatrix} \begin{Bmatrix} \frac{\partial P_v}{\partial t} \\ \frac{\partial T}{\partial t} \end{Bmatrix} = \bar{\nabla} \cdot \begin{bmatrix} K_{PP} & K_{PT} \\ K_{TP} & K_{TT} \end{bmatrix} \begin{Bmatrix} \bar{\nabla} P_v \\ \bar{\nabla} T \end{Bmatrix} + \begin{Bmatrix} \frac{C_m \rho_s P_v}{P_{v,sat}(T)^2} \frac{\partial P_{v,sat}(T)}{\partial T} \frac{\partial T}{\partial t} \\ L_v \sigma C_m \frac{\rho_s}{P_{v,sat}(T)} \frac{\partial P_v}{\partial t} \end{Bmatrix} \quad (15)$$

### 346 3.2 Numerical solution

347 Numerical simulation of highly coupled mass and heat transfers is carried out by the prediction model  
 348 represented by the system of partial differential equations PDEs (Eq. 15). The numerical  
 349 implementation of the model requires a powerful solver environment allowing the treatment of multi-  
 350 physical problems where several phenomena are studied simultaneously. Therefore, COMSOL  
 351 multiphysics® provides interfaces and a selection of mathematical algorithms for modeling and solving  
 352 multiphysics problems via calculation code based on the finite element FE method [50]. It is widely  
 353 used in the scientific community, particularly for the type of multi-physics problem that concerns us.

354 The physics used to solve the coupled system of equations is the mathematical module under the  
 355 general form PDEs. First, the material properties depending on the state variable are defined as

356 interpolation functions and the different constants and coefficients of the model are also defined. Both  
357 in terms of complexity and computational cost, it would be beneficial to have a simplified 1D model.  
358 This is considered justified, for two reasons: (1) Mass and heat transfer using the experimental setup is  
359 stipulated to be unidirectional due to the use of water and thermal insulation in the wall edges; (2)  
360 research has shown that, despite the spatial variability of wind-driven rain distribution across walls  
361 and in the absence of runoff, the redistribution of humidity in the plane of the wall is limited, and 1D  
362 heat and mass modelling is sufficiently accurate (except for very heterogeneous walls such as  
363 masonry) [51]. Then, the boundary and initial conditions were also defined by the interpolation  
364 functions. They are those measured experimentally by the sensors installed in the external/internal  
365 borders and through the wall.

366 Beyond that, the PDEs domain are meshed in space using the FE method. This latter is performed and  
367 controlled automatically by the solver with a very fine size of order of 0.0011 m. For time setting, the  
368 implicit Backward Differentiation Formulas (BDF) method has been chosen with adaptative mesh and  
369 maximal time step of 1 minute. The Multifrontal Massively Parallel Sparse MUMPS direct solver has  
370 been selected to solve the linear system. In addition, the fully coupled system given by Eq.15 has been  
371 solved simultaneously by the fully coupled mode. In fact, each time step yields a non-linear equation  
372 system that is linearized and iteratively solved by Newton's method [52]. The convergence criteria  
373 chosen is of order  $1e-4$  for each time step. The time-dependent solver calculates the solution of a  
374 possibly non-linear system of equations at each time step via a set of iterative techniques based on  
375 Newton's method. These Newton's method used for solving a nonlinear system of equations evaluate a  
376 function, as well as its derivative, at each time step. This derivative is also known as the Jacobian and  
377 is relatively expensive to calculate. Therefore, the software will try to minimize the re-evaluation of  
378 the Jacobian, by preference. If the nonlinear solver has difficulty converging, it will reduce the size of  
379 the requested time step and try to calculate the solution as detailed by Beneš et al. [53]. After running  
380 the simulation for the specified period, temperature, relative humidity, vapor pressure and heat and  
381 mass flows evolutions at any location with all-time steps can be determined.

### 382 **3.3 Model input parameters**

383 The prediction quality of the heat and mass transfer model requires reliable input parameters. a  
384 detailed characterization campaign of the hygrothermal transfer parameters is established and grouped  
385 in Table 2. In fact, the use of glass powder as a partial replacement of portland cement CEMI, of about  
386 20 %, allows to change the microstructure by creating micropores of order lower than  $0.01 \mu\text{m}$  as well  
387 as macropore of order higher than  $100 \mu\text{m}$ . This change of the pore size induces an increase of the  
388 total porosity of the material about 14.18 % compared to a reference concrete with a porosity of 13.14  
389 %. This means a decrease in thermal conductivity by 3.7 % and specific heat by 1.4 %. Regarding the  
390 mass transfer parameters, the incorporation of GP in concretes increases their moisture storage  
391 capacity by 20% and its dry vapor permeability 2 times more compared to the control concrete [54].

392 As for the wet water vapor permeability and the liquid water permeability, these are estimated by  
 393 using the inverse method based on gradient descent and reported in [45].

394 Table 2: Properties of studied material [54].

Property	Value & Expression	Identification method & experimental device
Dry thermal conductivity $\lambda_{dry}$	1290 [mW.m <sup>-1</sup> .K <sup>-1</sup> ]	Guarded hot plate method by $\lambda$ -Meter EP 500e® device [55,56]
Water thermal conductivity $\lambda_{water}$	607 [mW.m <sup>-1</sup> .K <sup>-1</sup> ]	-
Dry specific heat $C_{p\ dry}$	850 [J.kg <sup>-1</sup> .K <sup>-1</sup> ]	3D Calorimeter Calvet® [57]
Water specific heat $C_{p\ water}$	4400 [J.kg <sup>-1</sup> .K <sup>-1</sup> ]	-
Density $\rho_s$	2290 [kg.m <sup>-3</sup> ]	-
Water vapor permeability $\delta_p$	3.38e-11 exp(-5.998RH) [kg.m <sup>-1</sup> .s <sup>-1</sup> .Pa <sup>-1</sup> ]	Inverse method [45]
Water liquid permeability $k_l$	3.493e-13 exp(6.003RH)/RH [kg.m <sup>-1</sup> .s <sup>-1</sup> .Pa <sup>-1</sup> ]	Inverse method [45]

395 The thermal properties in the hydric state are given as below [58]:

396 
$$C_{p\ humid} = C_{p\ dry} + C_{p\ water} \cdot u \quad (16)$$

397 
$$\lambda_{humid} = \lambda_{dry} + \lambda_{water} \cdot \frac{\rho_s}{\rho_w} \cdot u \quad (17)$$

398 where u is the water mass content (kg/kg). It is determined by a gravimetric method using a ProUmid  
 399 SPS® device according to [59]. The sorption isotherm of the tested material is presented by the GAB  
 400 model [60] and given by Eq. (18), where  $m=0.5912$ ;  $C=9.953$  and  $K=0.913$ .

401 
$$u = \frac{m \cdot C \cdot K \cdot RH}{(1 - K \cdot RH)(1 + K \cdot (C - 1) \cdot RH)} \quad (18)$$

#### 402 **4 Wall scale scenarios and numerical simulation**

403 Two scenarios were performed in this study. In the first one, called "test under sinusoidal effects  
 404 without solar radiation nor rainfall", we considered sinusoidal conditions in the temperature with  
 405 alternating episodes of precipitation and radiation. The objective of this test is precisely to study the  
 406 effect of drying/wetting cycles without solar radiation/rainfall on the one hand, and to investigate the  
 407 capacity of the model to obtain the same results as the experimental one.

408 In the second test carried out, called "sinusoidal effects test with solar radiation and rainfall",  
 409 sinusoidal conditions in the temperature were considered with alternating episodes of rainfall and  
 410 radiation by varying the air temperature of the outdoor chamber according to a sinusoidal type signal.  
 411 The objective of this test is to investigate the capacity of the model to predict the hygrothermal  
 412 behavior of the wall.

413 Accordingly, Dirichlet boundary conditions are considered for the numerical calculation. The  
414 measurements provided by the sensors at x=0 and 11 cm are used to describe the temperature and  
415 relative humidity at the exterior and interior edges.

416 The mean error (ME) and the root mean square error (RMSE) were used to assess the consistency of  
417 the numerical results with the experimental datas.

$$418 \quad ME = \frac{\sum_{i=1}^n |y_{meas} - y_{num}|}{n} \quad (19)$$

$$419 \quad RMSE = \sqrt{\frac{\sum_{i=1}^n (y_{meas} - y_{num})^2}{n}} \quad (20)$$

420 where  $y_{meas}$  is the experimental measured values,  $y_{num}$  is the numerical model results and n is number  
421 of values.

#### 422 **4.1 Test without solar radiation nor rainfall (Test 1)**

423 Three hygrothermal sensors are installed in the two chambers. The temperature T and Relative  
424 Humidity RH variations of the room during the Test 1 are shown in Fig. 6. The T/RH and vapor  
425 pressure Pv evolution in the two chambers is shown in Fig. 7 and Fig. 8, respectively. We note that the  
426 two chambers are well insulated in relation to the room's climate. In the outdoor chamber, the  
427 temperature condition is sinusoidal, varying from 25 to 15 °C with a period of 1 day and this for a total  
428 period of 7 days. While it is constant in the internal compartment with a temperature equal to 20 °C.  
429 The humidity was left to evolve freely in the two chambers without the use of a humidity generator.  
430 An increase in the Pv in both chambers is observed. This is due to the interaction between the wall and  
431 the both chamber atmosphere. The RH values decrease as temperature increase in single cycles, while  
432 the overall trends in RH increase with time due to release of water vapor from the wall.

433

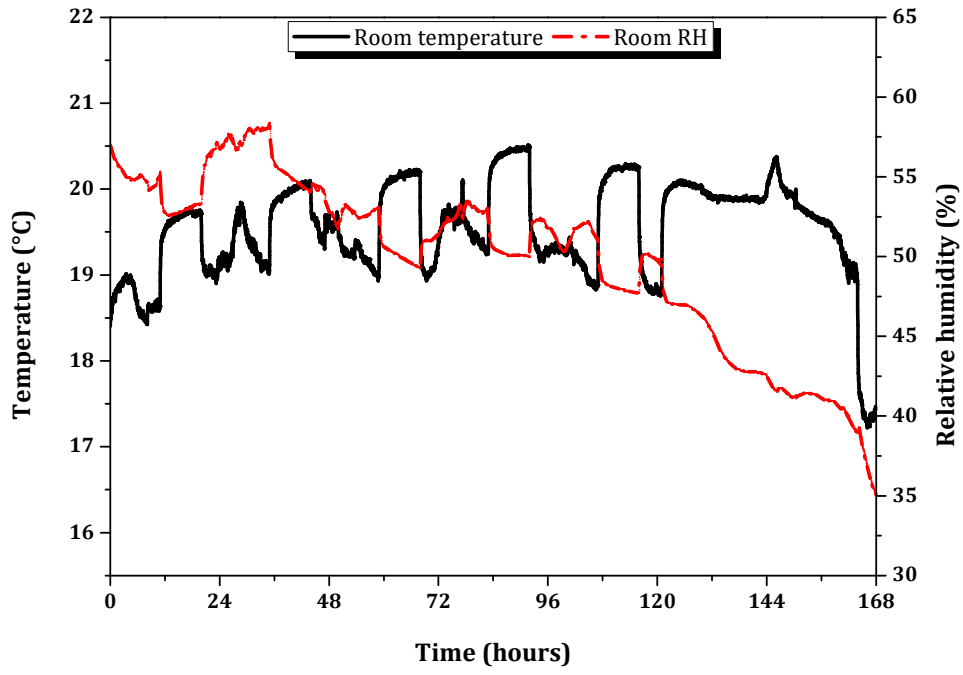

434

435

Fig. 6: T and RH of the room during the Test 1.

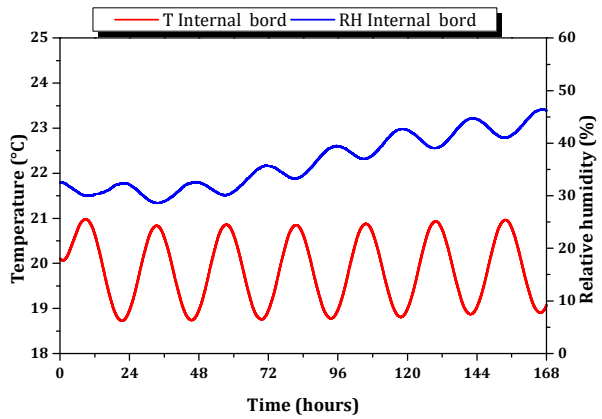
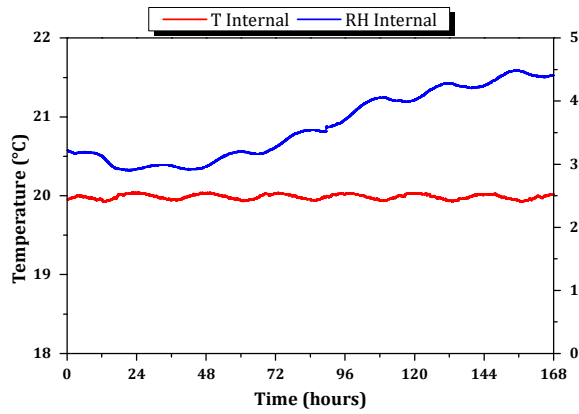
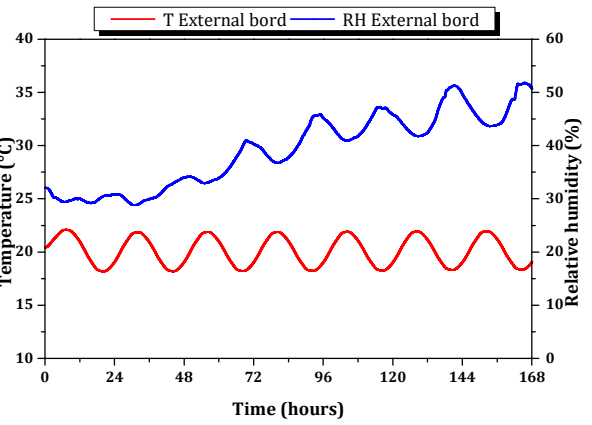
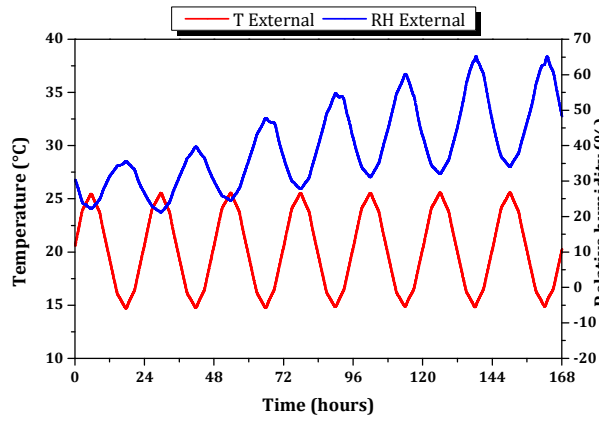

436

437

438

439

Fig. 7: Temperature conditions and relative humidity variation in the outdoor/indoor chambers & external/internal borders.

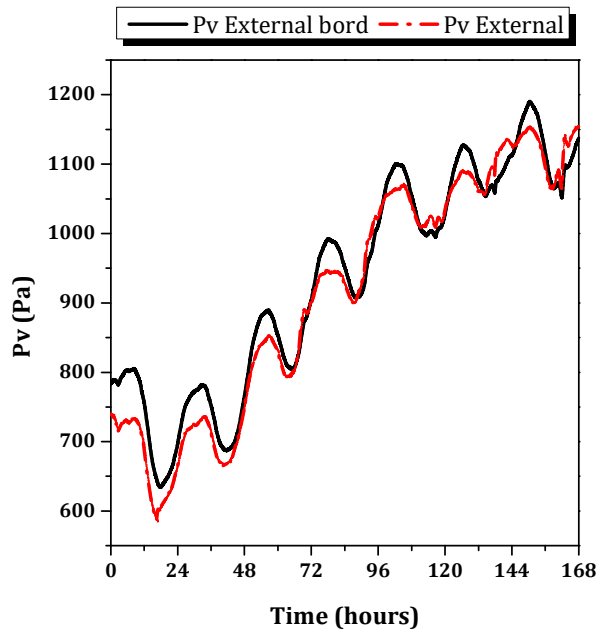
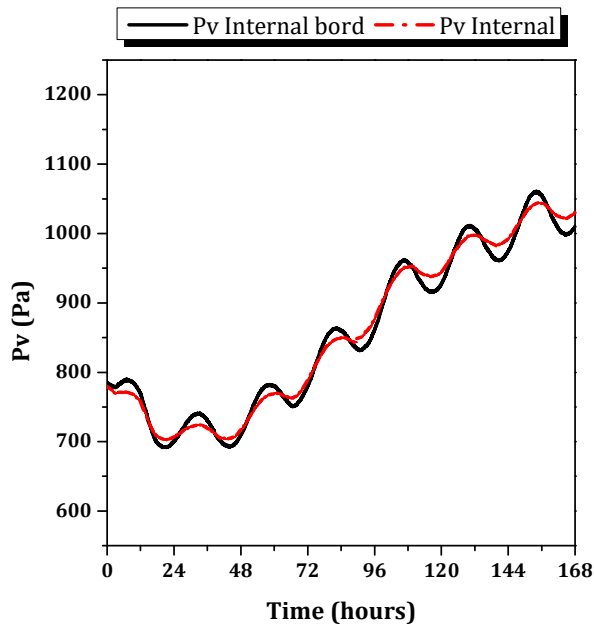

440

441

442

Fig. 8: Vapor pression in the outdoor/indoor chambers & external/internal borders.

443 The temperature evolution within the wall at different depths is shown in Fig. 9Fig. . The temperature  
444 variation in the outdoor chamber generates a variation in temperature and an increase in the relative  
445 humidity in the wall. In fact, the absolute temperature difference does not exceed 0.3 °C and it remains  
446 within the margin of error of the sensor used (see Table 1). The largest errors are recorded at the time  
447 of signal changing the outdoor chamber temperature. A good correlation between the experimental and  
448 numerical values are recorded with  $R^2= 0.9547, 0.9788$  and  $0.9668$  at 4, 6 and 9 cm, respectively.

449 In addition, the stability of the relative difference is noted between the experimental and numerical  
450 measurements, with an absolute deviation of the magnitude of 2%, 1% at 4 and 6cm and 5% at 9cm as  
451 shown in Fig. 10. Generally, a good prediction of RH through the wall is obtained using the proposed  
452 numerical model compared with the results from the experimental simulation. Table 3 shows the MEs  
453 and RMSEs between the numerical and experimental relative humidity/temperature at the depth of 4, 6  
454 and 9 cm. Numerical and experimental results have the maximum MEs which are 0.22 °C and 3.02 %,  
455 for the temperature and relative humidity, respectively. Furthermore, Numerical and experimental  
456 results have the maximum RMSEs of temperature and relative humidity which are 0.24 °C and  
457 4.78%, respectively.

458 This analysis has shown certain deviations between the experiment and numerical simulation,  
459 especially in the case of dynamic loads and during the time of relative humidity signal variation.  
460 However, these were not demonstrated clearly by literature and required further investigation [61].  
461 The deviations found may be related to several factors, in the one hand, the numerical solution of the  
462 prediction model (the choice of the solver, adequate mesh and the solution scheme), the formulation of  
463 the phenomenological models of hygrothermal transfers (the non-inclusion of certain physical  
464 phenomena) and the measurement uncertainties resulting from the experiment (sensor error and the  
465 impact of the environment on the measurement), and in the other hand, it may be related to the  
466 variability of the properties of the material used [62].

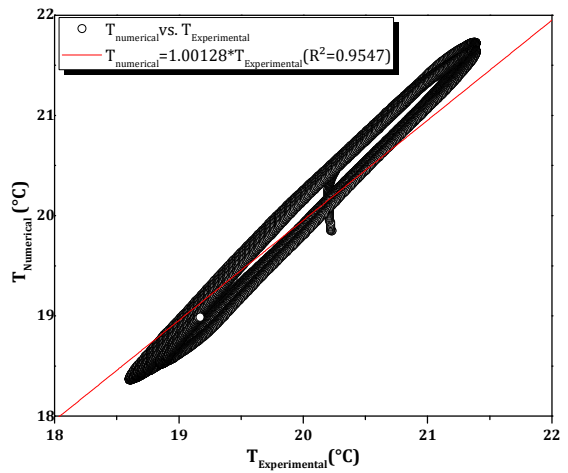
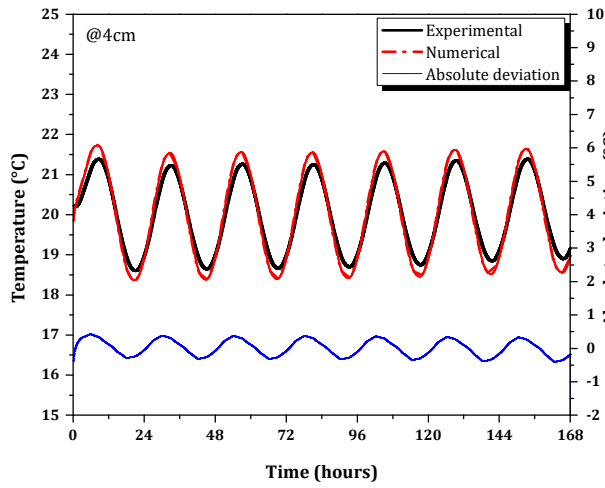

467

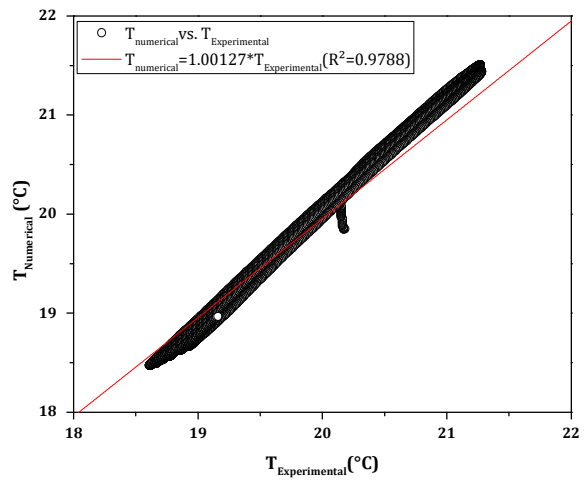
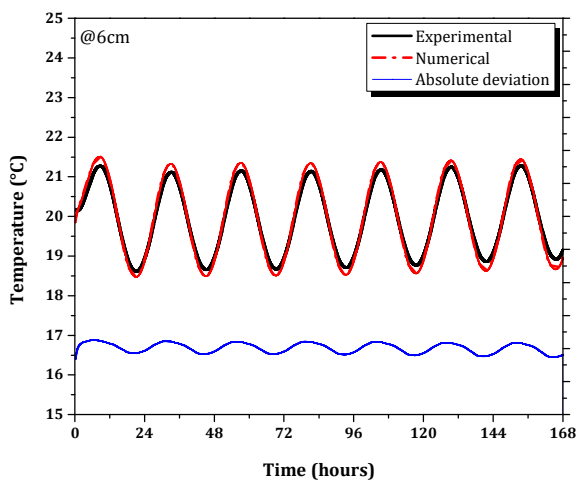

468

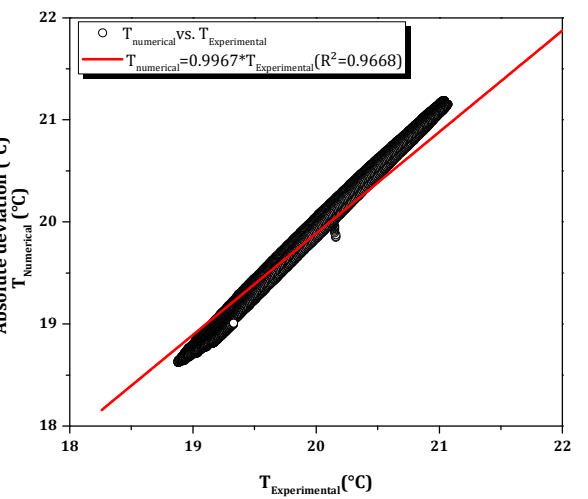
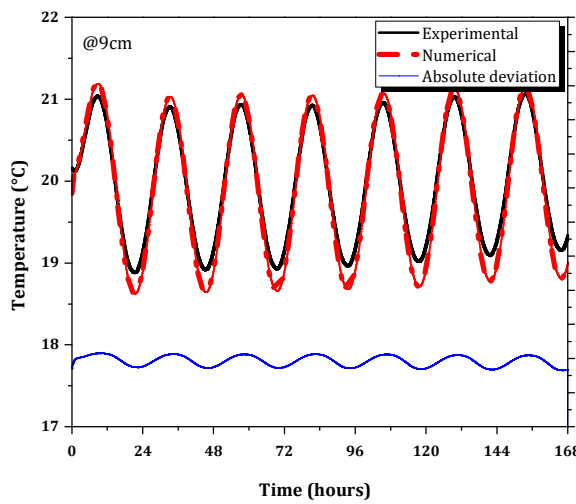

469

470

471

Fig. 9: Temperature evolution at 4, 6 and 9 cm.



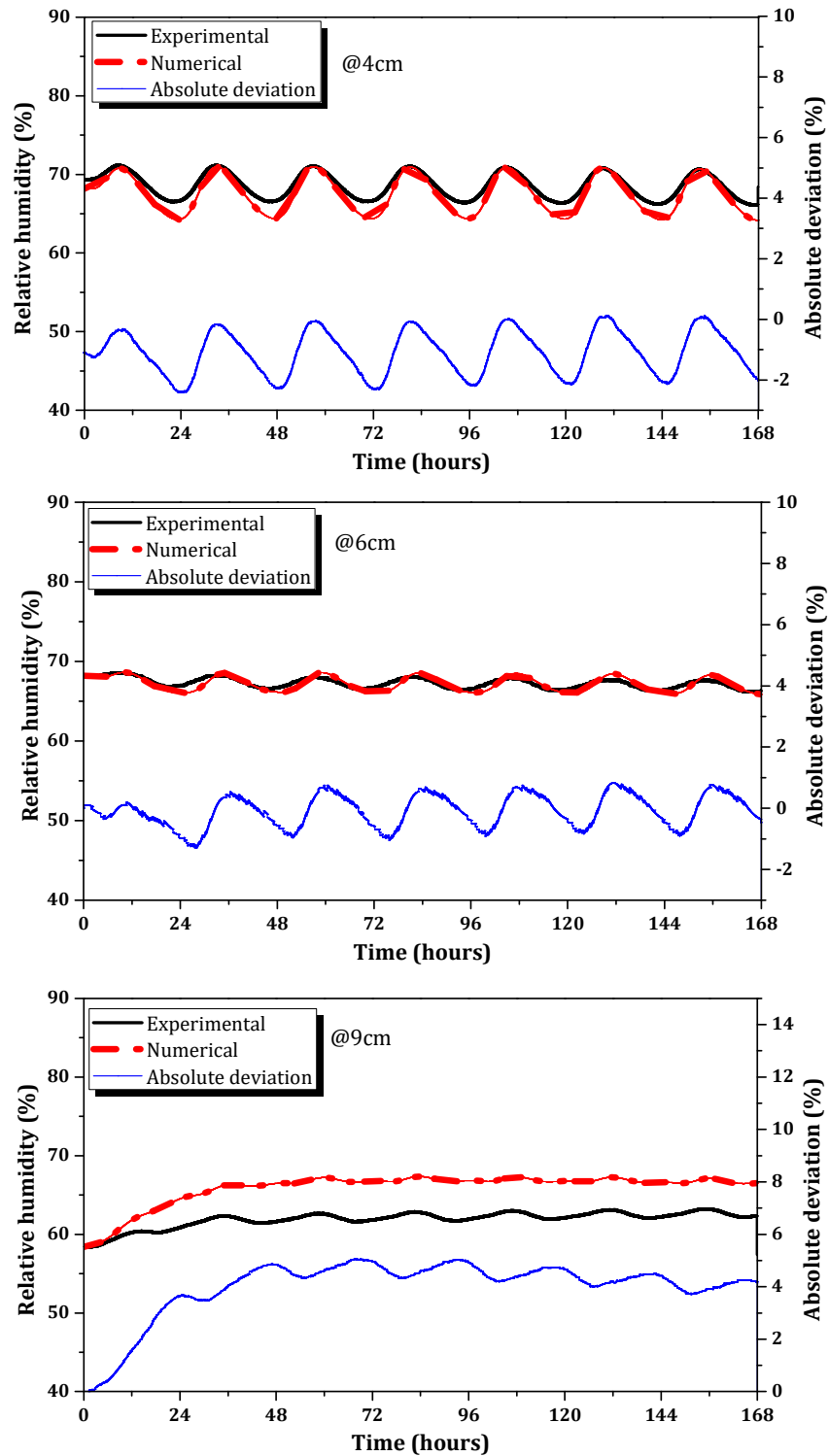

472

473

Fig. 10: Relative humidity evolution at 4, 6 and 9 cm.

474

In addition, the heat flux measurements were performed on the external and internal borders as shown in Fig. 11. The simulated heat flux is in good agreement with the measured flux. Indeed, a very good correlation between our experimental observation and the results of the numerical simulation can be seen with  $R^2=0.8864$  and  $0.9408$  for the external/internal border, respectively. However, the simulated flux at the external and internal borders is underestimated by 2.3% and overestimated by 10%

478

479 respectively, compared with the values measured experimentally. The MEs and RMSEs between the  
 480 numerical and experimental thermal flux at the external/internal borders are shown in Table 3. The  
 481 results have the maximum MEs which is 1.7 and 0.98  $\text{W}\cdot\text{m}^{-2}$ , at external/internal borders, respectively.  
 482 Furthermore, the RMSEs of being about 2.28 and 1.41  $\text{W}\cdot\text{m}^{-2}$  at the external/internal borders,  
 483 respectively. The numerical results of the model are in a good agreement with the measured data.

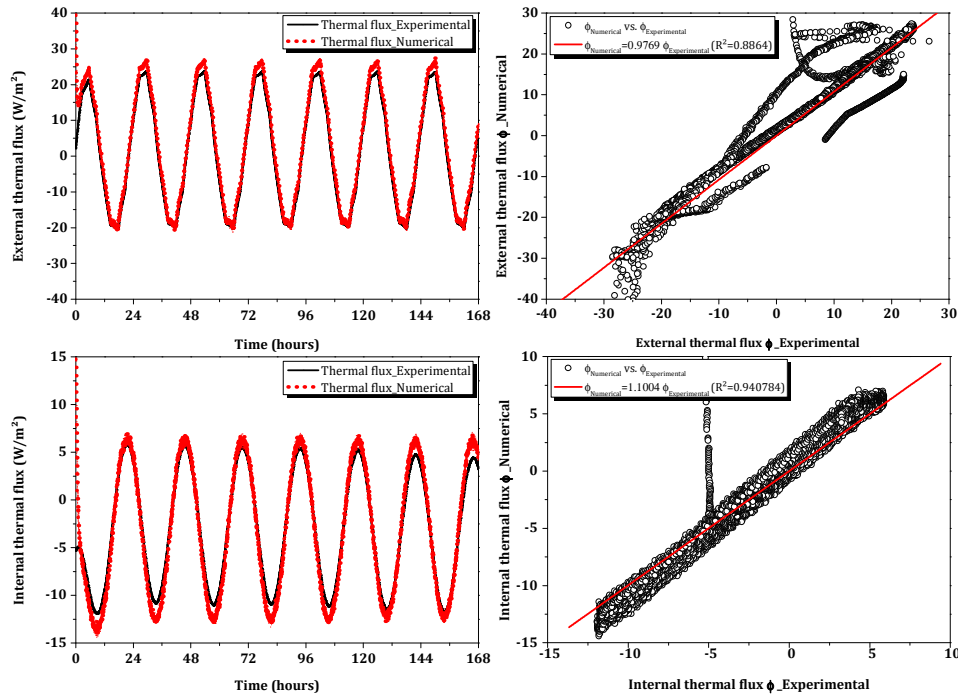

484

485 Fig. 11: Comparison of the conducted heat flux of the model prediction with the experimentally  
 486 measured heat flux at the external and internal borders.

487 Table 03: MEs and RMSEs between experimental and numerical results

		x=0	x=4cm	x=6cm	x=9cm	x=11cm
T [°C]	ME	-	0.22	0.13	0.14	-
	RMSE	-	0.24	0.15	0.17	-
RH [%]	ME	-	1.50	1.82	3.02	-
	RMSE	-	2.96	3.47	4.78	-
$J_q$ [ $\text{W}\cdot\text{m}^{-2}$ ]	ME	1.70	-	-	-	0.98
	RMSE	2.28	-	-	-	1.41

488

#### 489 4.2 Test with solar radiation and rainfall (Test 2)

490 The T and RH variations of the room during the Test 2 are shown in Fig. 12. The sinusoidal loadings  
 491 are used to get closer to the real conditions to which a building's walls are subjected. While respecting  
 492 the operating range of the climatic chamber, a configuration has been chosen that shows the variations  
 493 in T/RH, Pv and SWL/LWL solar radiation and rainfall as shown in Figs. 13, 14 and 15, respectively.  
 494 The two chambers built are well insulated from the climate of the room, both in temperature and  
 495 humidity. The temperature fluctuates between 28 and 15°C and a temperature peak is observed during  
 496 the radiation period due to the Joule effect. In fact, when applying solar radiation, the lamps heat the

497 internal air circulating in the chamber which is in contact with the hot surfaces of the lamps by  
 498 convective exchange [63]. The observed decrease in RH and an increase in Pv values was related to  
 499 the increase in temperature in the drying chamber over the duration of the experiment [64], after that,  
 500 an increase in RH is observed during the rainfall application due to the humidification of air by the  
 501 water rain. In addition, the variation of RH and Pv in the indoor chamber is partly due to the  
 502 interaction between the wall and the chamber atmosphere.

503 With regard to the evolution of the relative humidity, maximum values are observed during the  
 504 precipitation periods and minimum values during the radiation periods. The average flow of rain  
 505 infiltrated during the rainfall sequence was measured and is of the magnitude of 288 g/m<sup>2</sup>.h. With  
 506 regard to solar radiation, the average radiative fluxes are of the magnitude of 820 W/m<sup>2</sup> for short  
 507 wavelength illuminances and about 75 W/m<sup>2</sup> for long wavelength illuminances, as shown in Fig. 14.  
 508 These values were obtained for the whole sequence of solar irradiation.

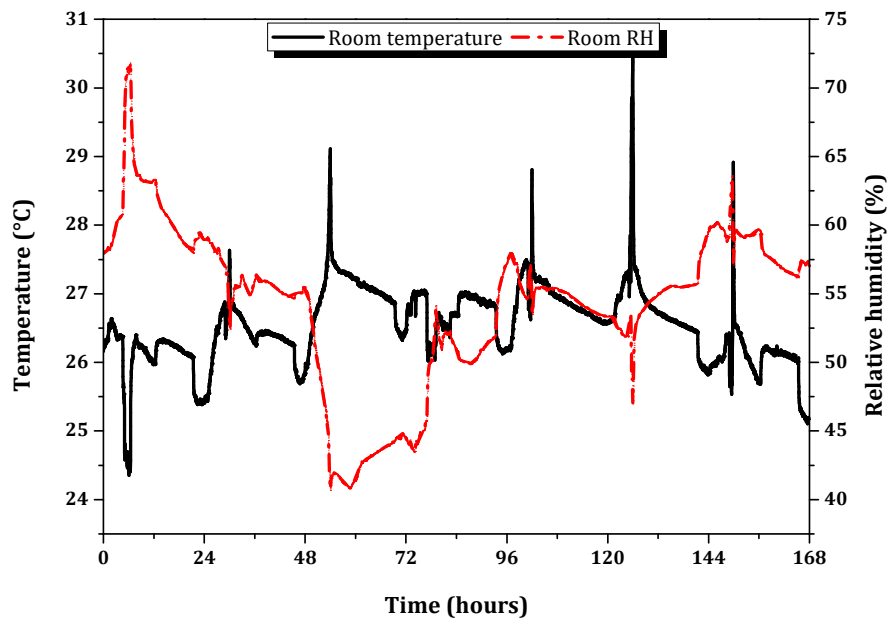

509

510 Fig. 12: T and RH of the room during the Test 2.

511 In the second compartment simulating the building environment, the temperature was set at 20 °C.  
 512 And following the evolution of the relative humidity inside as shown in Fig. 13, a slight fluctuation is  
 513 observed in the temperature measurement due to the temperature variation in the outdoor chamber. In  
 514 addition, a slight increase in the relative humidity in the indoor chamber is also observed due to the  
 515 interaction of the wetted wall with the indoor chamber during the precipitation phase.

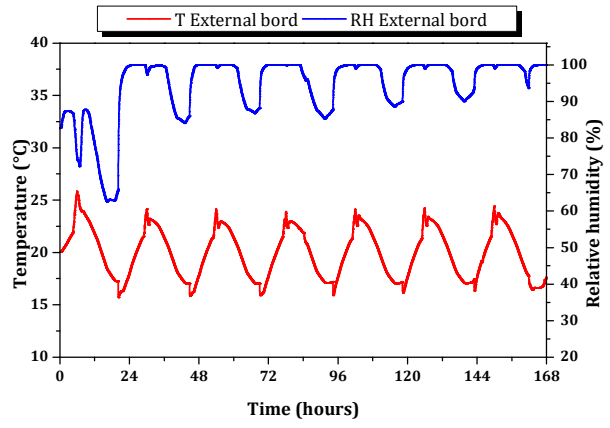
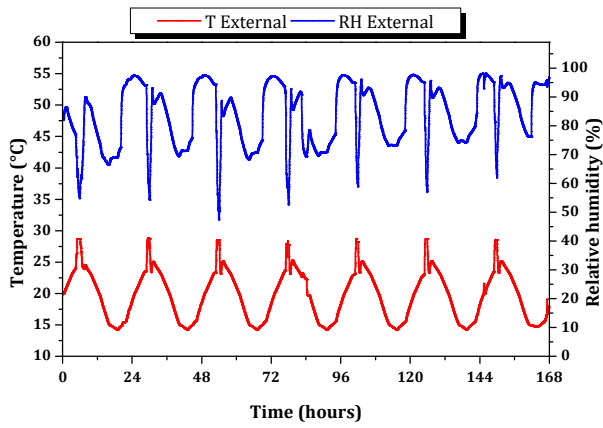

516

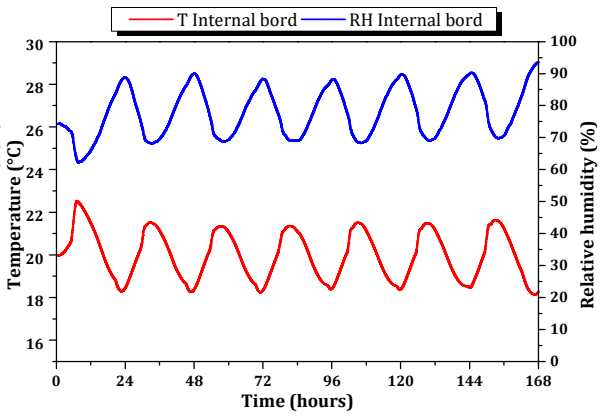
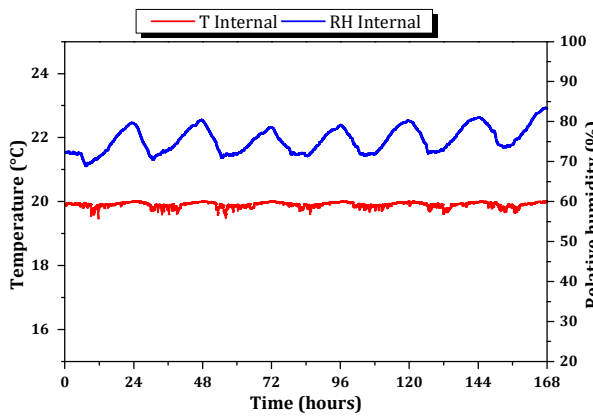

517

518

519

Fig. 13: Temperature conditions and relative humidity variation in the outdoor/indoor chambers & external/internal borders.

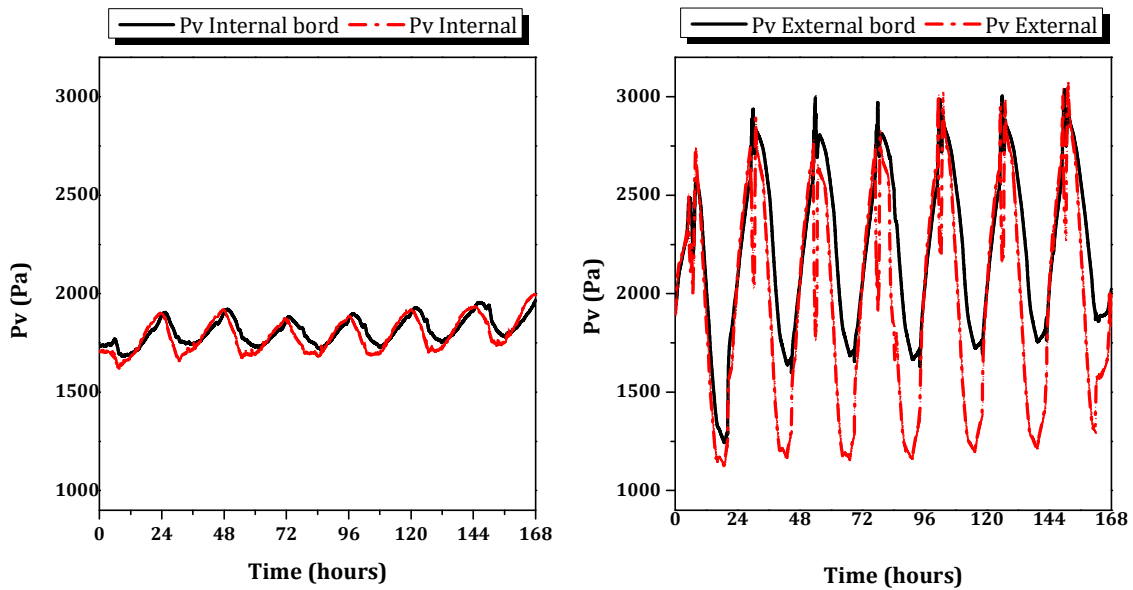

521

522

Fig. 14: Vapor pressure in the outdoor/indoor chambers & external/internal borders.

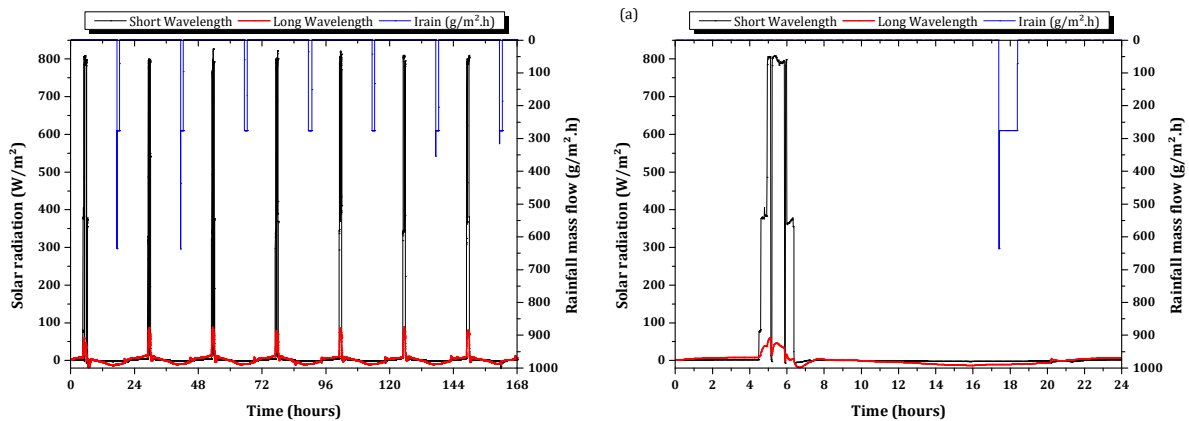

523

524 Fig. 15: The flow of radiation and rainfall infiltrated in the wall (external border): (a) representation of  
525 the sinusoidal sequence; (b) a zoom on a single period.

526 The hygrothermal behavior of the wall exposed to sinusoidal loading is presented at several depths: 4,  
527 6 and 9 cm. On the thermal transfer part, the temperature evolution in the wall can be seen in Fig. 16.  
528 The temperature varies in time between 26 and 14 °C. Indeed, the thermal wave imposed on the  
529 external side propagates in the wall and induces a response in phase with an amplitude that becomes  
530 more and more attenuated as one moves away from the external border. This begins with a period of  
531 drying by solar radiation. Therefore, the amplitude of the first sequence is greater than the remaining  
532 ones by about 1.5 °C, 1.3 °C and 0.9 °C at 4, 6 and 9 cm respectively. After that, the wall studied is  
533 subjected to cooling during the rainfall periods, and subsequently the amplitude of the response of the  
534 wall to the imposed conditions is reduced. In addition, the largest errors are recorded at the time of the  
535 temperature signal change in the outdoor chamber and the application of solar radiation and rainfall  
536 periods, but these always remain within the error range of the sensors used. A good correlation

537 between the experimental and numerical values are recorded with  $R^2 = 0.978, 0.9827$  and  $0.9838$  at 4,  
538 6 and 9 cm, respectively.

539 On the mass transfer part, the oscillations of the RH of the wall in time in response to the dynamic  
540 conditions is shown in Fig. 17. The largest errors are recorded at the time of the change of temperature  
541 and relative humidity in the outdoor chamber. Indeed, during rainfall periods, the wall undergoes a  
542 wetting by liquid water. Then, during the application of solar radiation, the wall is dried out. In  
543 addition, the stability of the relative difference is noted between the experimental and numerical  
544 measurements, with a maximum absolute deviation of the magnitude of 4% at 4 and 6 cm, remaining  
545 within the tolerance of the sensors used. Indeed, the deviation at 9 cm begins at about 3% and ends at  
546 8% at the end of Test 2. However, the deviation is maximal at the time of the temperature signal  
547 change. This is explained by the fact that the relative humidity is dependent on the temperature, and by  
548 the effect of hysteresis between the curves of the sorption and desorption isotherms [65]. These results  
549 can be related with the water content using the sorption isotherm, that it is the transport vector for  
550 aggressive agents such as sulfates, carbonations and chlorides, and which presents an indicator of the  
551 sustainability of porous building materials [66].

552 Table 4 shows the MEs and RMSEs of the numerical and experimental measurement of T/RH. The  
553 MEs and RMSEs of T and RH simulated by the present model are very close at each measurement  
554 location in the wall. The ME of T/RH at 4, 6 and 9 cm is within the range of  $0.14 - 0.20$  °C and  $1.44 -$   
555  $3.02$  %, whereas the RMSE is within the range of  $0.18-0.23$  °C and  $1.81-3.47$  %.

556

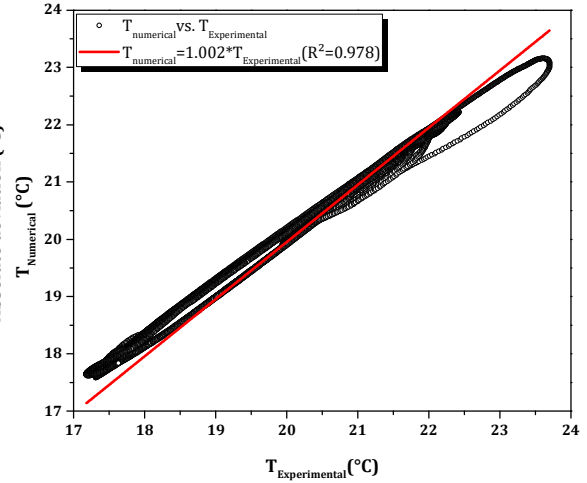
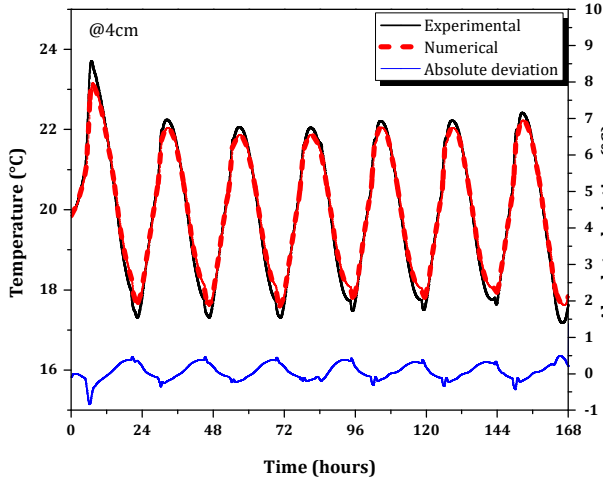

557

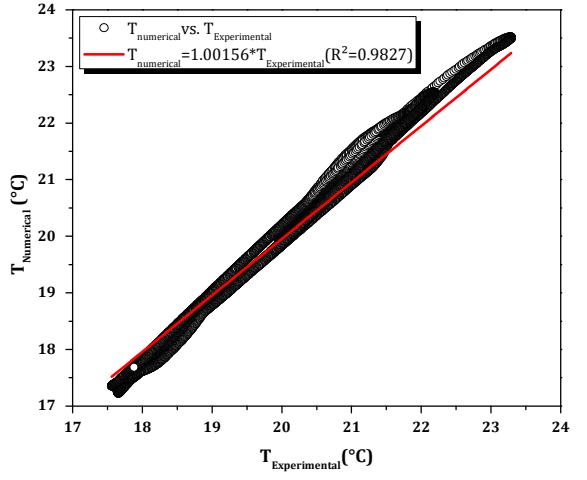
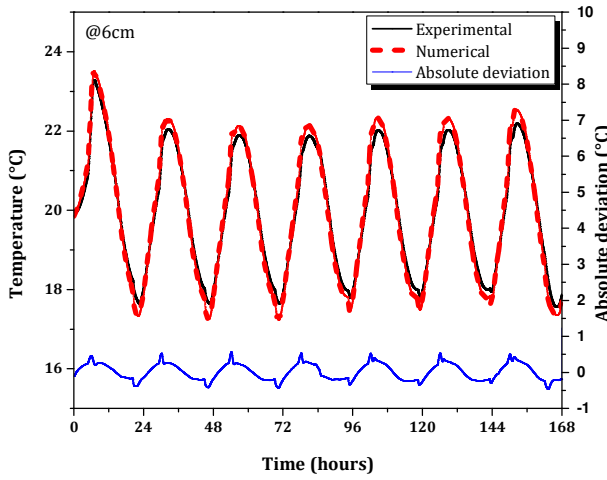

558

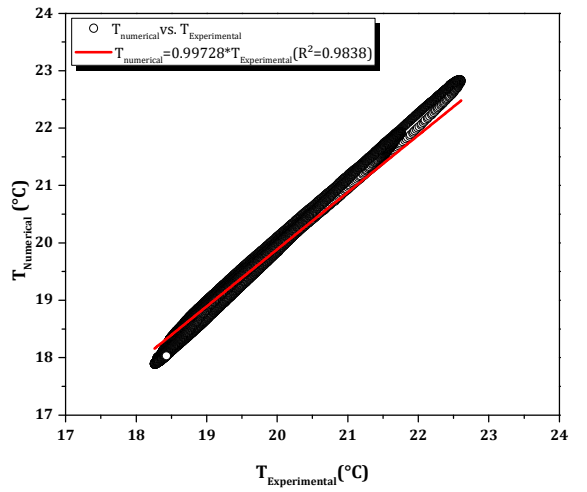
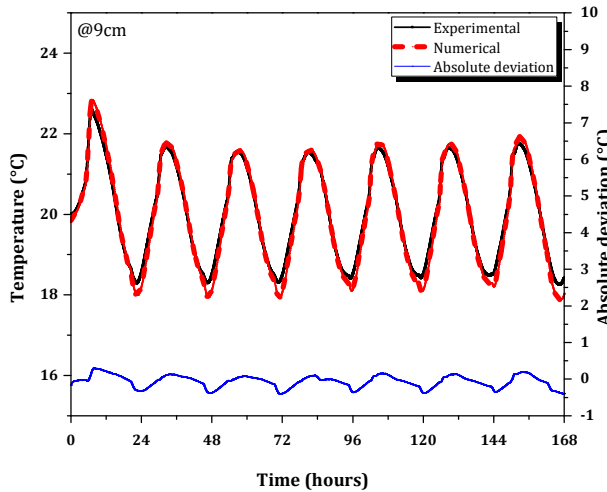

559

560

Fig. 16: Temperature evolution at 4, 6 and 9 cm.

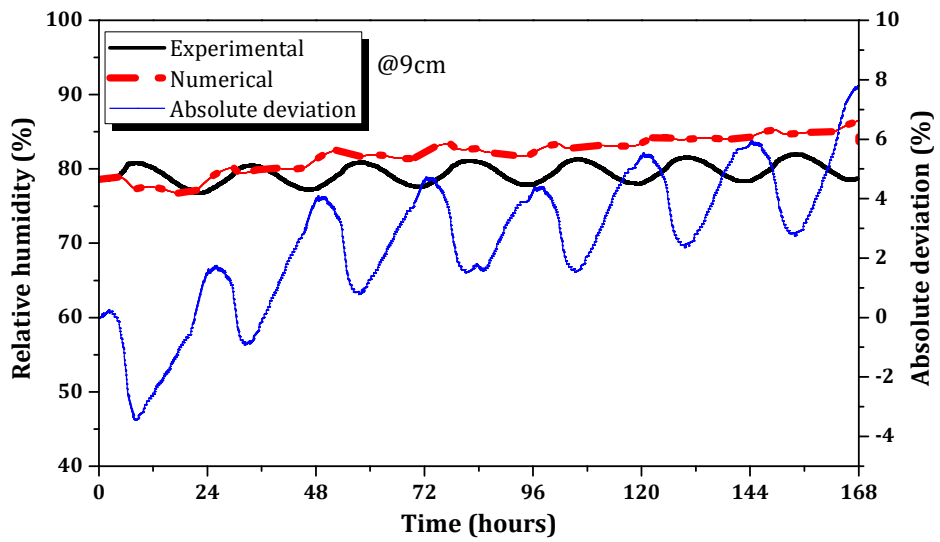
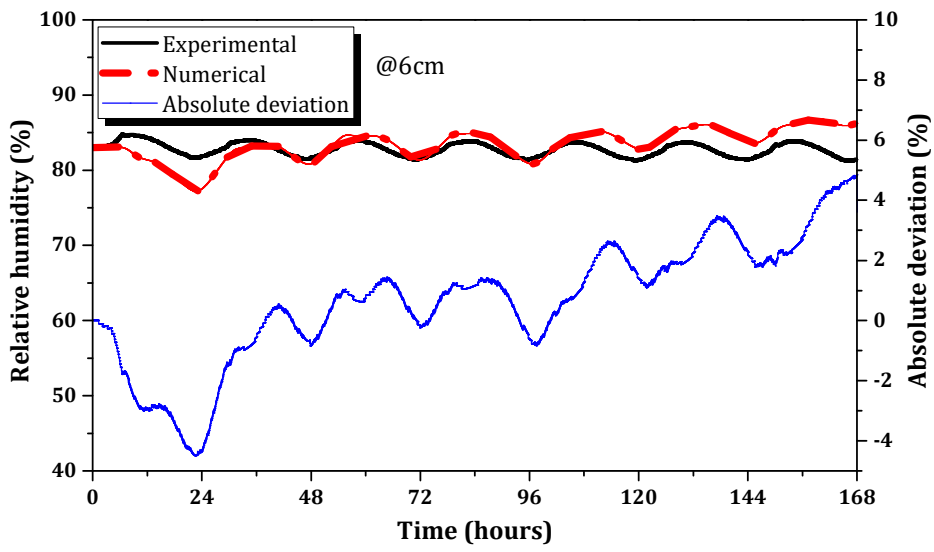
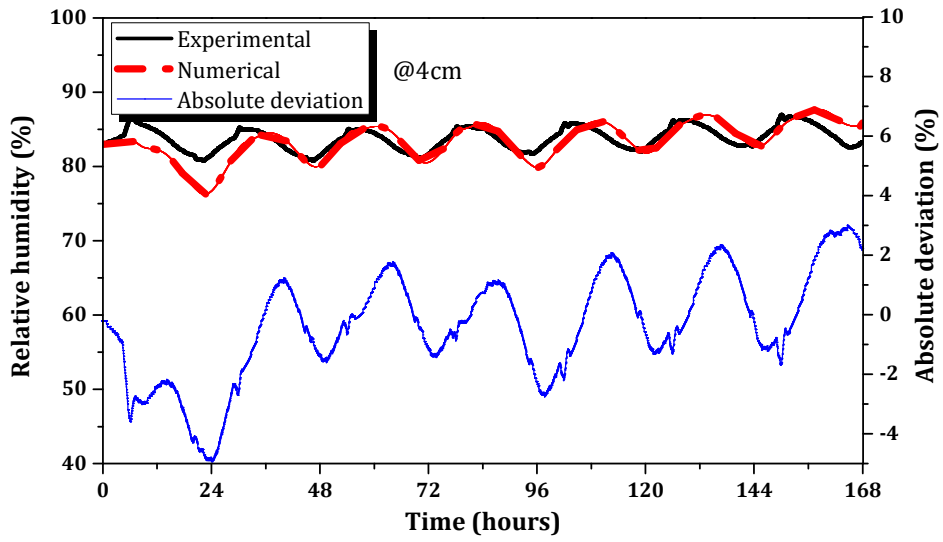

561

562

Fig. 17: Relative humidity evolution at 4, 6 and 9 cm.



563 In addition, the conducted heat flux measurements were performed on the external and internal  
564 borders, as shown in Fig. 18. The results vary between 100 and -40 W/m<sup>2</sup> at the external border and  
565 between 10 and -5 W/m<sup>2</sup> at the internal border. These values are in agreement with the experimental  
566 results obtained from a building scale measurement campaign [36]. The simulated heat flux is in good  
567 agreement with the measured flux with R<sup>2</sup> = 0.8964 and 0.7884 for the external/internal border,  
568 respectively. Indeed, a good correlation between our experimental observation and the results of the  
569 numerical simulation can be seen. However, the simulated flux at the external and internal borders is  
570 overestimated by 7% and underestimated by 0.15% respectively, compared with the values measured  
571 experimentally. This discrepancy, as mentioned before, can be attributed in part to the fact that the  
572 sensor is impermeable to mass transfer. Finally, the ME and RMSE shown in Table 4 of the thermal  
573 flux is about 6.71 – 7.79 and 3.07 – 3.64 W.m<sup>-2</sup> at the external/internal border, respectively. These  
574 values are tolerable and within the margin of accuracy of the sensors used (See Table 1).

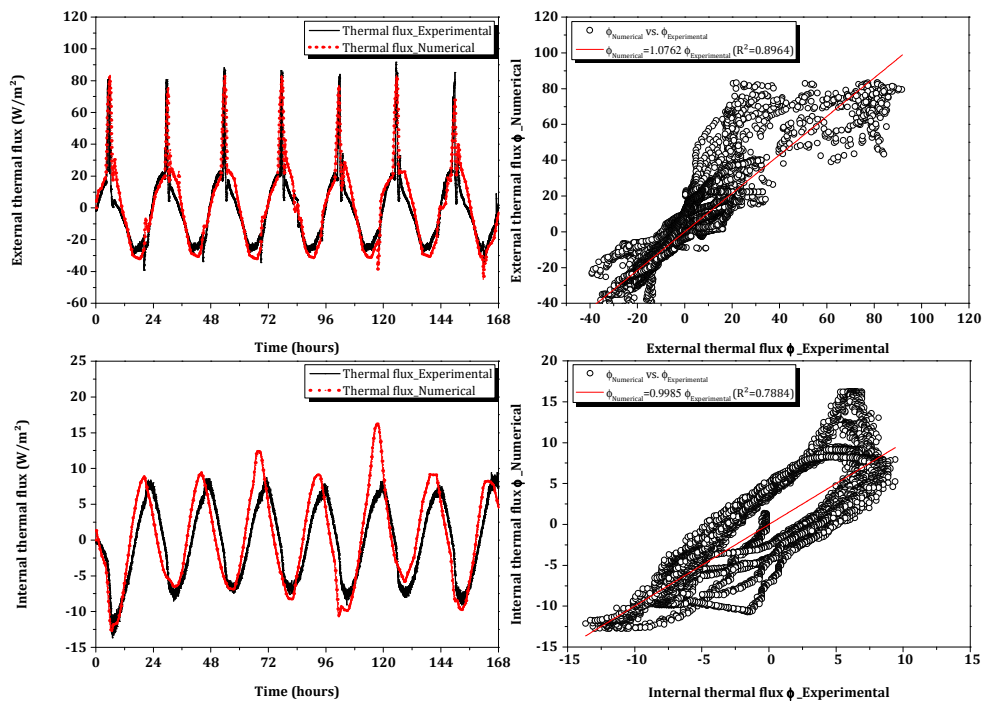

575

576 Fig. 18: Comparison of the conducted heat flux of the model prediction with the experimentally  
577 measured heat flux at the external and internal borders.

578 Table 04: MEs and RMSEs between experimental and numerical results.

		x=0	x=4cm	x=6cm	x=9cm	x=11cm
T [°C]	ME	-	0.18	0.20	0.14	-
	RMSE	-	0.23	0.23	0.18	-
RH [%]	ME	-	1.44	1.70	3.02	-
	RMSE	-	1.81	2.12	3.47	-
J <sub>q</sub> [W.m <sup>2</sup> ]	ME	6.71	-	-	-	3.07
	RMSE	7.79	-	-	-	3.64

579

580 **4.3 Comparison between Test 1 and 2**

581 In order to identify the effect of solar radiation and rainfall on the hygrothermal transfer. A  
582 comparison between the both tests was conducted in term of simulated mass flow received in the wall  
583 as shown in Figs. 19 and 20. The mass flow at the external borders varies with the same shape as the  
584 external loads in T and RH for both tests. It can be seen that the mass flow is larger by 3.33 times in  
585 Test 2 than in Test 1 with significant peaks, due to the wetting by liquid water from a rainfall period  
586 which the quantity is measured and reported in Fig. 15 of about  $280 \text{ g.m}^{-2}.\text{h}^{-1}$ . Nevertheless, the solar  
587 radiation also contributes to the drying of the wall. Moreover, and during solar radiation, a high heat  
588 flux of about  $820\text{W.m}^{-2}$  is applied to the external border (see Fig. 15). This evaporates the rainwater  
589 stored and trapped in the wall. In general, the mass flux at the external border varies between  $-1\text{e-}3 -$   
590  $1.5\text{e-}3 \text{ kg.m}^{-2}.\text{s}^{-1}$  and  $-5\text{e-}3 - 5\text{e-}3 \text{ kg.m}^{-2}.\text{s}^{-1}$  for Test 1 and Test 2, respectively. As for the mass flow at  
591 the internal border, the value fluctuates between about  $-3\text{e-}4 - 3\text{e-}4 \text{ kg.m}^{-2}.\text{s}^{-1}$  and  $-4\text{e-}5 - 4.5\text{e-}5 \text{ kg.m}^{-2}.\text{s}^{-1}$   
592  $\text{kg.m}^{-2}.\text{s}^{-1}$  for Test 1 and Test 2 respectively. This is due to the fact that the water storage-destorage takes  
593 place mainly on the outer side where the dynamic water flow happens.

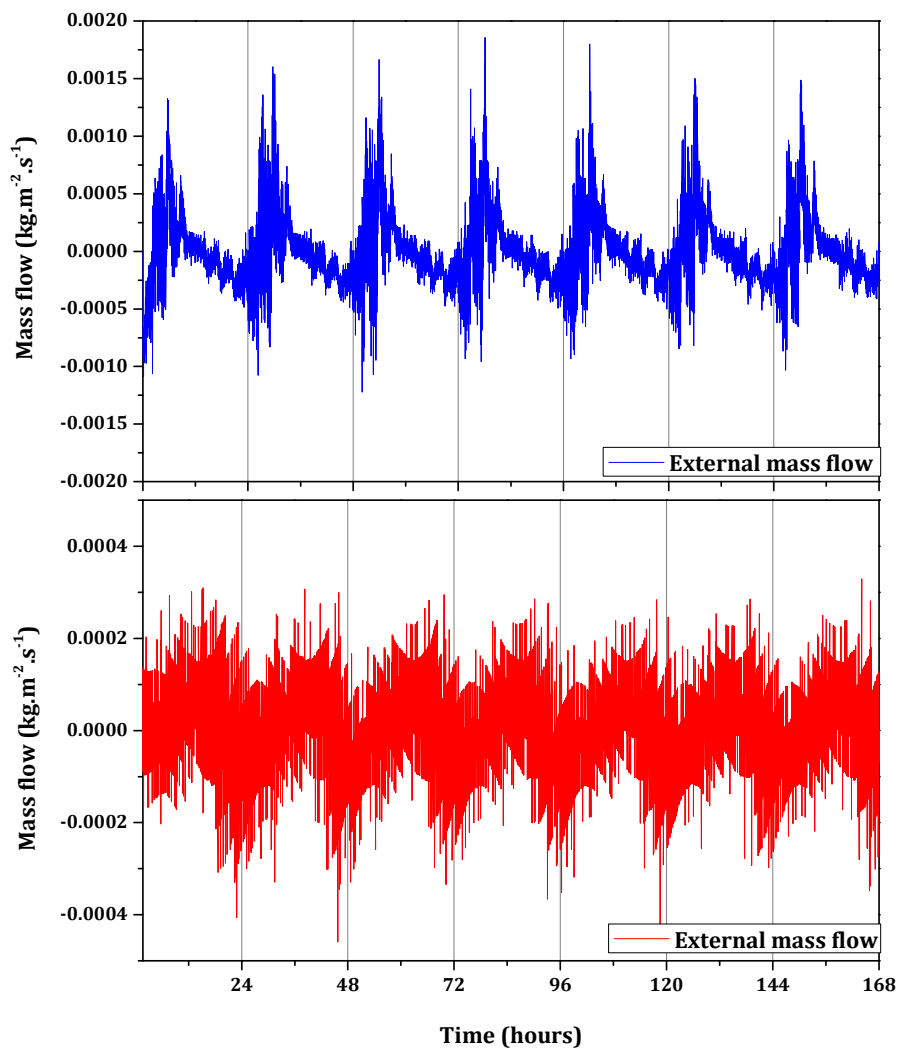

594

595

Fig. 19 : Mass flow evolution at the external/internal border-Test 1.

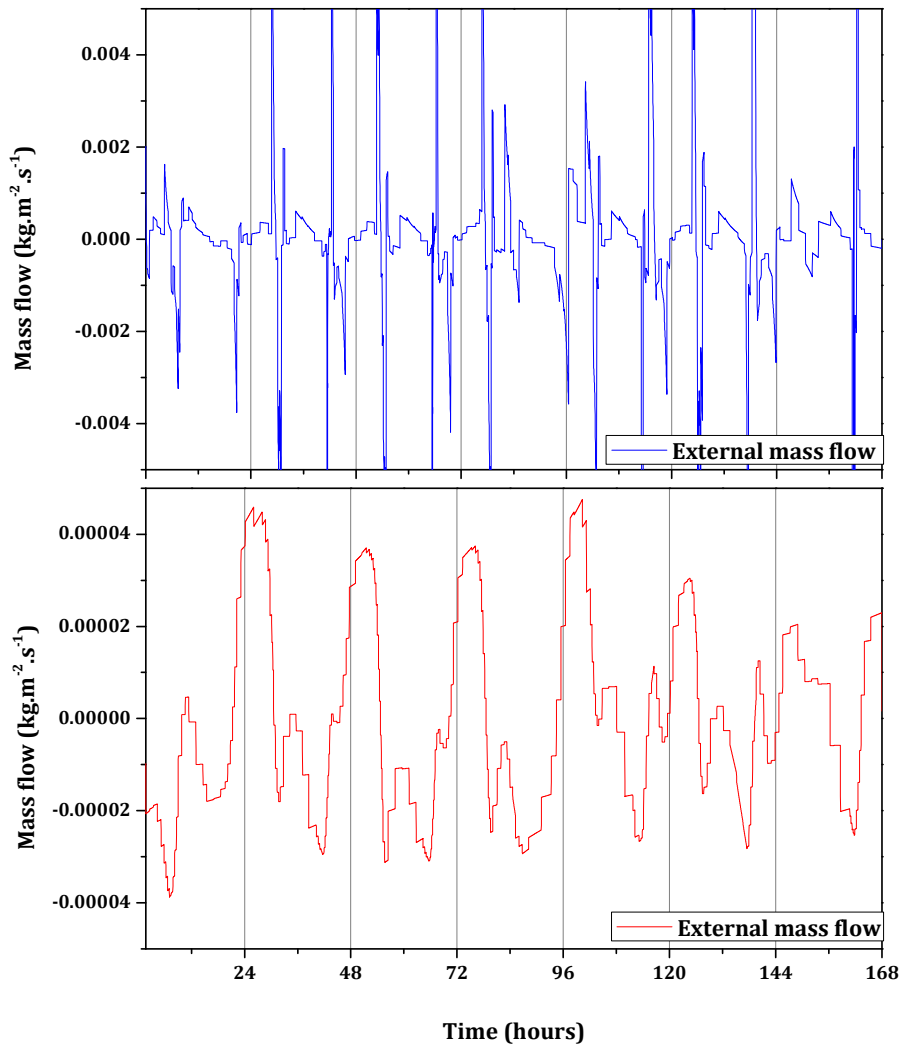
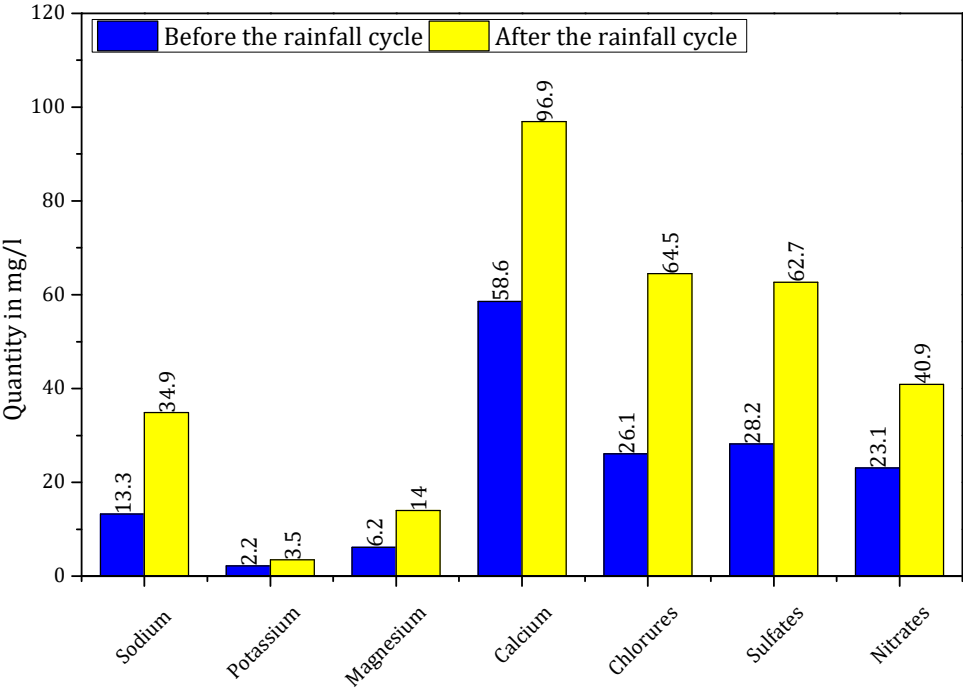

Fig. 20: Mass flow evolution at the external/internal border-Test 2.

#### 4.4 Chemical composition analysis

In this section, chemical composition analysis by ion chromatography (IC) of the rainwater before and after the application of 7 rainfall sequences is measured using an 883 Basic Ion Chromatograph Plus from Metrohm®. This analysis allows us to identify and quantify perfectly the chemical elements present in the solution. In addition, the number of chemical analyses is limited to the initial and final ones due to the fact that the adopted rainfall system is a closed water circuit and it is installed inside the chamber. This allows the temperature of the rainwater to have the same temperature as the chamber environment. In order not to influence this temperature and the climatic conditions applied to the external border during the opening and closing of the compartment, it was required to analyse the water just at the beginning and at the end of the test. Fig. 21 presents a dissolution of the elements of sodium, potassium, magnesium, nitrates and a large quantity of calcium and sulphates. These chemical species are leached from the wall made of the studied eco-concrete, which change its microstructure and chemical composition altering its chemical resistance [67]. The high pH of concrete which protect the steel reinforcements from corrosion and attacks by aggressive agents is lowered affecting the

612 durability of the concrete. In fact, the van der Waals force between the mortar and coarse aggregate on  
 613 the wall surface is reduced under the effect of rain erosion, which causes microcracks in the transition  
 614 zone of the interface. With increasing rain erosion time, the microcracks become progressively larger,  
 615 and the small pores on the concrete surface gradually deteriorate into large pores [68]. However, the  
 616 chemical analysis shows an increase in the amount of chloride present in the water used during the  
 617 rainfall. The chloride content in the wall decreases with application of the rainfall period [69].



618

619

Fig. 21: Chemical composition of rainwater before and after rainfall cycle.

620 **5 Sensitivity analysis**

621 In this section, the objective is to evaluate the effect of several parameters on the response of the  
 622 hygrothermal model. Indeed, the effect of the variations of several material parameters on the  
 623 numerical results was evaluated by considering  $\pm 20\%$  of variations of these inputs compared to their  
 624 reference values. This part of the study deals with the influence of input material parameters on the  
 625 model's results. Significant errors are usually present on these parameters, due to measurement  
 626 uncertainties at the material scale, or to the use of these parameters at higher scales as mentioned  
 627 earlier (wall and building scales). This latter reason (transition from the material to the wall scale) may  
 628 be responsible for much higher uncertainties on input values, because manufacturing a sample of large  
 629 dimensions can probably generate a wider range of uncertainties on the materials properties and on the  
 630 homogeneity of the system [70]. In the present work, to evaluate the influence of a varying parameter  
 631 on the resulting T and Pv profiles, the relative sensitivity index is calculated as follows [71]:

$$S (\%) = \frac{Y_{p+\delta p} - Y_{p-\delta p}}{2Y_p} \times 100 \quad (21)$$

Where Y is the solution of the model (T or P<sub>v</sub>), Y<sub>p</sub> is the reference solution obtained when no parameter is changed (all parameters are set to their reference values), p indicates the variable parameter and δp the variation range. This relative sensitivity index is calculated considering 20% of variation of input parameters with respect to their reference values ranging from 20% [72]. Low percentages represent errors that may occur at the material scale, while high percentages are related to errors at higher scales due to the accumulation of small errors. The sensitivity of the present model has been investigated with respect to the following parameters: density, heat capacity, thermal conductivity, water vapor/liquid permeability and sorption isotherm that is used to define the water content w in the hygrothermal model under the thermodynamic equilibrium hypothesis.

In this step, each parameter was changed separately considering 20% of variation (δP : – 20% and +20% of the reference value), while the other parameters were kept constant at their initial values. The different configurations of this sensitivity analysis are summarized in Figs. 22 and 23. Calculations were carried out for the two tests previously described in section 4 (test under sinusoidal effects without solar radiation nor rainfall and test with solar radiation and rainfall). Indeed, 13 different simulations were run for each scenario, representing a total of 26 simulations for the overall study. Figs. 22 and 23 show the T and P<sub>v</sub> sensitivity evolutions at different depths (4, 6 and 9cm) for Test 1 and Test 2, respectively. Which were calculated considering variations of ±20% on each parameter with respect to the reference value. It can be observed that the maximum sensitivity values are reached at the same time as the external temperature signal changes and not exceed 0.2% for Test 1 and 0.6% for Test 2, whether it is for thermal conductivity, heat capacity and density, and the change effect of mass transfer parameter on the heat transfer is very negligible. From the mass transfer point of view, the impact of density variation and sorption isotherms is very dominant and may reach 1.5% for both tests, compared to vapor permeabilities which has almost no effect. Whereas the thermal conductivity, liquid permeability and specific heat variation allows a change in the mass transfer sensitivity results with 0.25% and 0.75 % for Test 1 and Test 2, respectively.

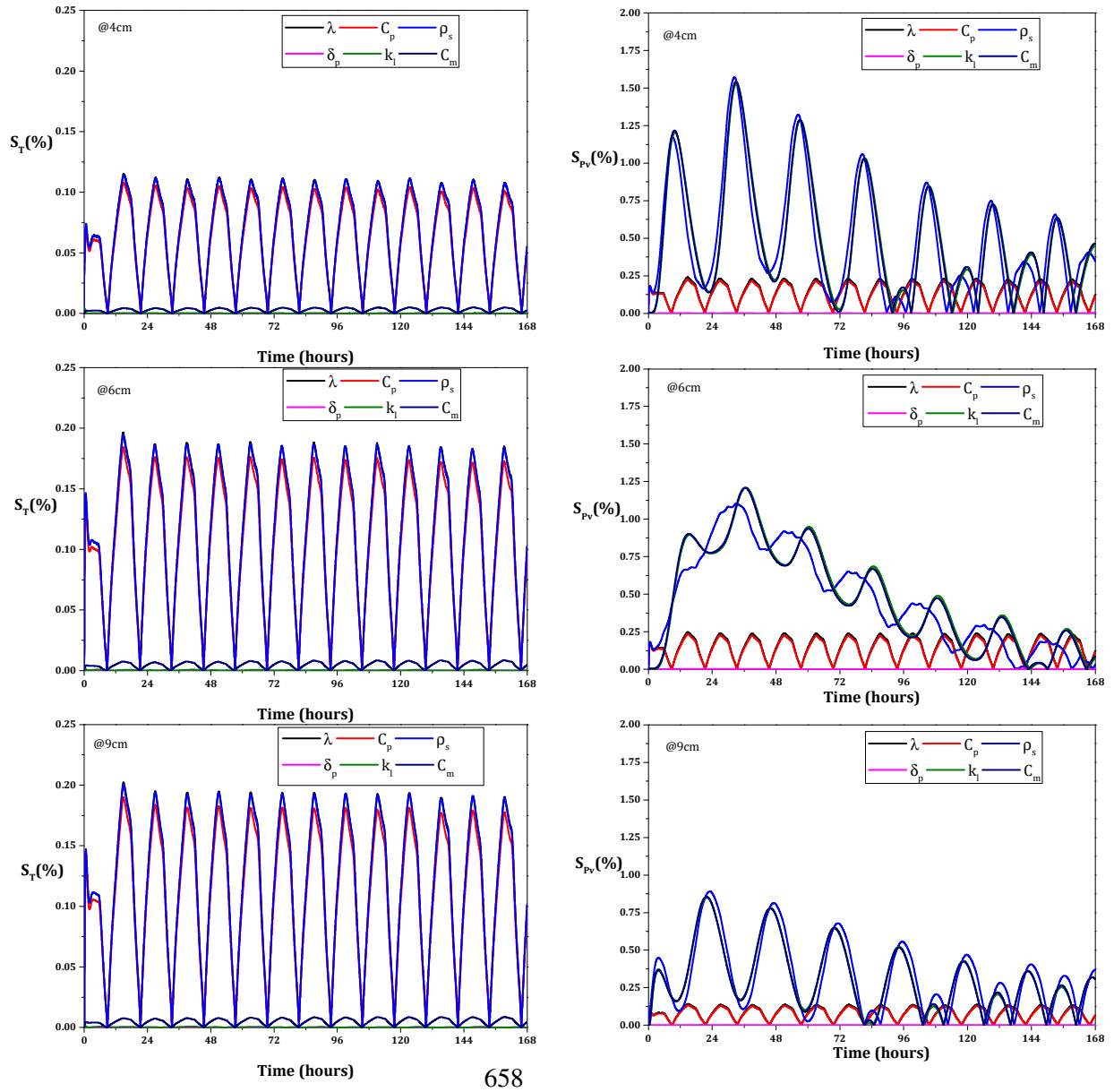

658

659

Fig. 22: T and Pv sensitivities evolution to a  $\pm 20\%$  change of parameters related to reference value and at different depths of the studied wall: 4 , 6 and 9cm - Test 1.

660

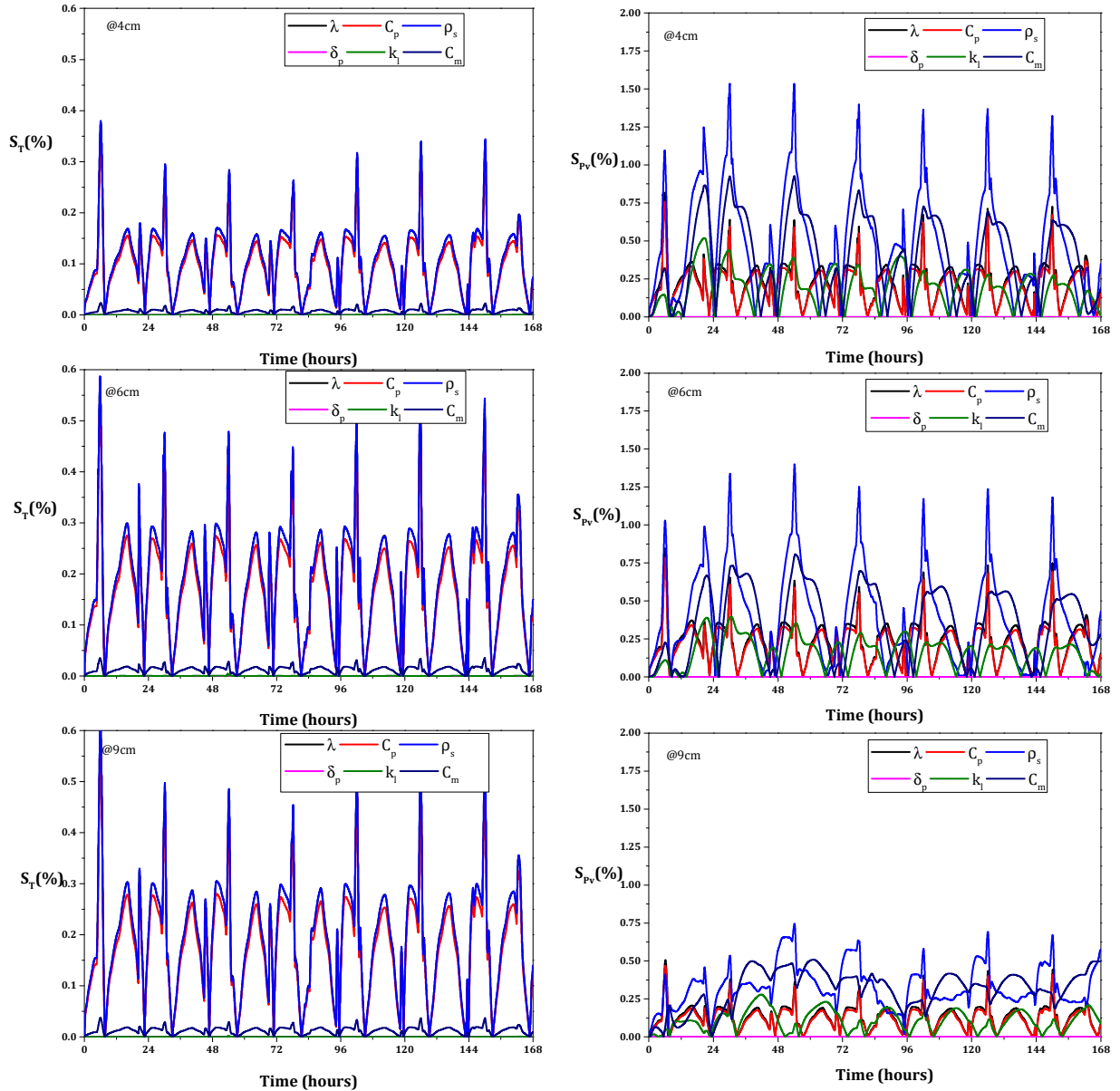

661

662

Fig. 23: T and Pv sensitivities evolution to a  $\pm 20\%$  change of parameters related to reference value and at different depths of the studied wall: 4 , 6 and 9cm - Test 2.

663

664 **6 Conclusion**

665

This article presents an experimental and numerical study of the hygrothermal behavior of a wall building made of new eco-concrete based on glass powder as a partial replacement of cement. The wall is subjected to drying/wetting by dynamic climatic conditions such as solar radiations and rainfall which are rarely studied in the literature. The coupled heat and mass transfer model takes into account the effect of solar radiations and rainfall at the boundaries. The hygrothermal envelope model was validated by comparison against experimental results. The experimental data have been generated via the developed experimental bench. This apparatus allows the simulation of different climatic

671

672 conditions, such as variations of temperature, humidity, rainfall and solar radiation. The simulation of  
673 the hygrothermal behavior of the eco-concrete wall highlights that the hygrothermal model is required  
674 for better prediction the relative humidity and temperature response through the wall as well as the  
675 heat flux at the external/internal borders.

676 For the first test without solar radiation nor rainfall, the absolute deviation does not exceed 0.3 °C for  
677 the temperature and 2% for relative humidity. For thermal flux, a very good correlation between our  
678 experimental observation and the results of the numerical simulation is found. It is underestimated by  
679 2.3% and overestimated by 10% for the internal and external borders respectively, compared with the  
680 values measured experimentally.

681 In the case of second test with solar radiation and rainfall, the largest errors are recorded at the time of  
682 the maximum or minimum value of temperature in the outdoor chamber, but these always remain  
683 within the error range of the sensors used, and gradually as we get further away from the external  
684 border. Concerning the thermal flux, the simulated heat flux is in good agreement with the measured  
685 flux. The simulated flux is overestimated by 7% and underestimated by 0.15% at the external and  
686 internal borders respectively, compared with the values measured experimentally.

687 The proposed model has a good agreement with the experimental results, and the ME and RMSE of  
688 the temperature, relative humidity and thermal flux are within the acceptable levels. As for the mass  
689 flow at the external border, it varies between  $-1e-3 - 1.5e-3 \text{ kg.m}^{-2}.\text{s}^{-1}$  and  $-5e-3 - 5e-3 \text{ kg.m}^{-2}.\text{s}^{-1}$  for  
690 Test 1 and Test 2, respectively. At the internal border, the value fluctuates between about  $-3e-4 - 3e-4$   
691  $\text{kg.m}^{-2}.\text{s}^{-1}$  and  $-4e-5 - 4.5e-5 \text{ kg.m}^{-2}.\text{s}^{-1}$  for Test 1 and Test 2, respectively. To summarize, the mass  
692 flow is larger by 3.33 times in Test 2 than in Test 1 with significant peaks and the solar radiation  
693 contributes to the drying of the wall by evaporating the rainwater stored and trapped in the wall.

694 The chemical analysis of the water used to simulate rainfall before and after rain sequences show a  
695 release of chemical species from the studied wall. These chemical species are responsible for the  
696 chemical resistance and the high pH of an eco-concrete. In addition, the analysis showed a release of  
697 an amount of chloride responsible for the corrosion of the reinforced concrete steels.

698 A sensitivity analysis was also carried out and it showed that envelope hygrothermal performance is  
699 very sensitive to thermal conductivity, heat capacity and density for the thermal transfer and to  
700 sorption isotherm curve, density and less important for the thermal conductivity, heat capacity and  
701 water liquid permeability for the mass transfer and even negligible for the water vapor permeability.

702 In over all, this data can be used in the energy performance study of environmentally friendly  
703 buildings. Indeed, further development of the hygrothermal transfer model in porous media, taking



704 into account the effect of radiation on rainfall and vice versa, the using flux-type boundary conditions  
705 and the sustainability study of wall studied is the objective of future studies.

## 706 **Acknowledgement**

707 The Nouvelle Aquitaine Region and the European Union support the project < CPER-FEDER  
708 Bâtiment durable Axis 2 MADUR Project: High-performance building materials with low  
709 environmental impact, sustainable and resilient > within the framework of the "Operational Program  
710 FEDER/FSE 2015-2020" and the Energy saving certificate program of the Ministry of Ecological and  
711 Solidarity Transition "SmartReno support" 2019–2021.

## 712 **References**

- 713 [1] S. Roels, Experimental analysis of moisture buffering. Final Report IEA-ECBCS Annex 41  
714 'Whole Building Heat, Air, Moisture Response'. Leuven: ACCO, (2008).
- 715 [2] F. Tariku, K. Kumaran, P. Fazio, Erratum to: Determination of indoor humidity profile using a  
716 whole-building hygrothermal model, *Build. Simul.* 4 (2011) 277–277.  
717 <https://doi.org/10.1007/s12273-011-0033-8>.
- 718 [3] H. Ge, X. Yang, P. Fazio, J. Rao, Influence of moisture load profiles on moisture buffering  
719 potential and moisture residuals of three groups of hygroscopic materials, *Build. Environ.* 81  
720 (2014) 162–171. <https://doi.org/10.1016/j.buildenv.2014.06.021>.
- 721 [4] L.K. Holm A, Moisture buffering effect—experimental investigations and validation, in: *Proc.*  
722 *Build. X Conf. Therm. Perform. Exter. Envel. Whole Build. Clear. Bach, FL, USA., 2007*.
- 723 [5] K. Abahri, R. Belarbi, N.O. B, N. Issaadi, M. Ferroukhi, Total Pressure Gradient Incidence on  
724 Hygrothermal Transfer in Highly Porous Building Materials, *Adv. Mater. Res.* 772 (2013)  
725 124–129. <https://doi.org/10.4028/www.scientific.net/AMR.772.124>.
- 726 [6] M.Y. Ferroukhi, R. Djedjig, K. Limam, R. Belarbi, Hygrothermal behavior modeling of the  
727 hygroscopic envelopes of buildings: A dynamic co-simulation approach, *Build. Simul.* 9 (2016)  
728 501–512. <https://doi.org/10.1007/s12273-016-0292-5>.
- 729 [7] M.Y. Ferroukhi, R. Belarbi, K. Limam, W. Bosschaerts, Impact of Coupled Heat and Moisture  
730 Transfer, *Therm. Sci.* 21 (2017) 1359–1368.
- 731 [8] Z. Slimani, A. Trabelsi, J. Virgone, R.Z. Freire, Study of the hygrothermal behavior of wood  
732 fiber insulation subjected to non-isothermal loading, *Appl. Sci.* 9 (2019).  
733 <https://doi.org/10.3390/app9112359>.
- 734 [9] A. Trabelsi, Z. Slimani, J. Virgone, Response surface analysis of the dimensionless heat and  
735 mass transfer parameters of Medium Density Fiberboard, *Int. J. Heat Mass Transf.* 127 (2018)  
736 623–630. <https://doi.org/10.1016/j.ijheatmasstransfer.2018.05.145>.
- 737 [10] T. Alioua, B. Agoudjil, N. Chennouf, A. Boudenne, K. Benzarti, Investigation on heat and  
738 moisture transfer in bio-based building wall with consideration of the hysteresis effect, *Build.*  
739 *Environ.* 163 (2019) 106333. <https://doi.org/10.1016/j.buildenv.2019.106333>.
- 740 [11] T. Alioua, B. Agoudjil, A. Boudenne, K. Benzarti, Sensitivity analysis of transient heat and  
741 moisture transfer in a bio-based date palm concrete wall, *Build. Environ.* 202 (2021) 108019.  
742 <https://doi.org/10.1016/j.buildenv.2021.108019>.
- 743 [12] A. V. Luikov, Heat and mass transfer in capillary-porous bodies, Pergamon Press. Oxford 1  
744 Édn. (1966).

- 745 [13] A. Trabelsi, R. Belarbi, K. Abahri, M. Qin, Assessment of temperature gradient effects on  
746 moisture transfer through thermogradient coefficient, *Build. Simul.* 5 (2012) 107–115.  
747 <https://doi.org/10.1007/s12273-012-0063-x>.
- 748 [14] M. Qin, R. Belarbi, Development of an analytical method for simultaneous heat and moisture  
749 transfer in building materials utilizing transfer function method, *J. Mater. Civ. Eng.* 17 (2005)  
750 492–497. [https://doi.org/10.1061/\(ASCE\)0899-1561\(2005\)17:5\(492\)](https://doi.org/10.1061/(ASCE)0899-1561(2005)17:5(492)).
- 751 [15] M.Y. Ferroukhi, R. Belarbi, K. Limam, Effect of Hygrothermal Transfer on Multilayer Walls  
752 Behavior, Assessment of Condensation Risk, *Adv. Mater. Res.* 1051 (2014) 647–655.  
753 <https://doi.org/10.4028/www.scientific.net/AMR.1051.647>.
- 754 [16] H.S.L.C. Hens, Heat, Air and Moisture Transfer In Highly Insulated Building Envelopes  
755 (HAMTIE), IEA ECBCS Annex. 24 (2002) 21.
- 756 [17] J. Grunewald, Diffusiver und konvektiver Stoff- und Energie- transport in kapillarporösen  
757 Baustoffen, Diss. TU Dresden. (1996) 220.
- 758 [18] A. Janssens, Reliable control of interstitial condensation in lightweight roof systems, Leuven,  
759 1997.
- 760 [19] A. TenWolde, Moisture Transfer Through Materials and Systems in Buildings, in: *Water Vap.*  
761 *Transm. Through Build. Mater. Syst. Mech. Meas.*, ASTM International, 100 Barr Harbor  
762 Drive, PO Box C700, West Conshohocken, PA 19428-2959, n.d.: pp. 11-11–8.  
763 <https://doi.org/10.1520/STP22953S>.
- 764 [20] S.L.C.H. Hens, *Building Physics - Heat, Air and Moisture 3e Fundamentals and Engineering*  
765 *Methods with Examples and Exercises*, Wilhelm Ernst & Sohn, Berlin, Germany, 2017.  
766 <https://doi.org/10.1002/9783433608548>.
- 767 [21] M. Rahim, O. Douzane, A.D. Tran Le, G. Promis, T. Langlet, Experimental investigation of  
768 hygrothermal behavior of two bio-based building envelopes, *Energy Build.* 139 (2017) 608–  
769 615. <https://doi.org/10.1016/j.enbuild.2017.01.058>.
- 770 [22] P.A. Moradas, P.D. Silva, J.P. Castro-Gomes, M.V. Salazar, L. Pires, Experimental study on  
771 hygrothermal behaviour of retrofit solutions applied to old building walls, *Constr. Build.*  
772 *Mater.* 35 (2012) 864–873. <https://doi.org/10.1016/j.conbuildmat.2012.04.138>.
- 773 [23] M.Y. Ferroukhi, K. Abahri, R. Belarbi, K. Limam, A. Nouviaire, Experimental validation of  
774 coupled heat, air and moisture transfer modeling in multilayer building components, *Heat Mass*  
775 *Transf. Und Stoffuebertragung.* 52 (2016) 2257–2269. <https://doi.org/10.1007/s00231-015-1740-y>.
- 777 [24] R. Tejada-Vázquez, E.V. Macias-Melo, I. Hernández-Pérez, K.M. Aguilar-Castro, J. Serrano-  
778 Arellano, Empirical model of hygrothermal behavior of masonry wall under different climatic  
779 conditions using a hot box, *Energy Build.* 249 (2021) 111209.  
780 <https://doi.org/10.1016/j.enbuild.2021.111209>.
- 781 [25] P.M. Congedo, C. Baglivo, D. D’Agostino, G. Quarta, P. Di Gloria, Rising damp in building  
782 stones: Numerical and experimental comparison in lecce stone and carparo under controlled  
783 microclimatic conditions, *Constr. Build. Mater.* 296 (2021) 123713.  
784 <https://doi.org/10.1016/j.conbuildmat.2021.123713>.
- 785 [26] M.-A. Hamdaoui, M.-H. Benzaama, Y. El Mendili, D. Chateigner, A review on physical and  
786 data-driven modeling of buildings hygrothermal behavior: Models, approaches and simulation  
787 tools, *Energy Build.* 251 (2021) 111343. <https://doi.org/10.1016/j.enbuild.2021.111343>.
- 788 [27] H.M. Künzle, *Simultaneous Heat and Moisture Transport in Building Components One and*

- 789 two dimensional calculation using simple parameter, Fraunhofer IRB Verlag. (1995).
- 790 [28] S. Rouchier, M. Woloszyn, G. Foray, J.-J. Roux, Influence of concrete fracture on the rain  
791 infiltration and thermal performance of building facades, *Int. J. Heat Mass Transf.* 61 (2013)  
792 340–352. <https://doi.org/10.1016/j.ijheatmasstransfer.2013.02.013>.
- 793 [29] H. Janssen, Wind-driven rain as a boundary condition for HAM simulations: Analysis of  
794 simplified modelling approaches, *Build. Environ.* 42 (2007) 1555–1567.  
795 <https://doi.org/10.1016/j.buildenv.2006.10.001>.
- 796 [30] H. Janssen, Conservative modelling of the moisture and heat transfer in building components  
797 under atmospheric excitation, *Int. J. Heat Mass Transf.* 50 (2007) 1128–1140.  
798 <https://doi.org/10.1016/j.ijheatmasstransfer.2006.06.048>.
- 799 [31] T. Ihara, B.P. Jelle, T. Gao, A. Gustavsen, Aerogel granule aging driven by moisture and solar  
800 radiation, *Energy Build.* 103 (2015) 238–248. <https://doi.org/10.1016/j.enbuild.2015.06.017>.
- 801 [32] B. Blocken, J. Carmeliet, A simplified numerical model for rainwater runoff on building  
802 facades: Possibilities and limitations, *Build. Environ.* 53 (2012) 59–73.  
803 <https://doi.org/10.1016/j.buildenv.2012.01.010>.
- 804 [33] B. Blocken, D. Derome, J. Carmeliet, Rainwater runoff from building facades: A review,  
805 *Build. Environ.* 60 (2013) 339–361. <https://doi.org/10.1016/j.buildenv.2012.10.008>.
- 806 [34] American Society of Heating, Refrigerating and Air-Conditioning Engineers (ASHRAE), 2013.  
807 ANSI/ASHRAE Standard 55-2013: Thermal Environmental Conditions for Human  
808 Occupancy. American Society of Heating, Refrigerating and Air-Conditioning Engineers, Inc.,  
809 (2013).
- 810 [35] S.E. Ouldboukhitine, R. Belarbi, R. Djedjig, Characterization of green roof components:  
811 Measurements of thermal and hydrological properties, *Build. Environ.* 56 (2012) 78–85.  
812 <https://doi.org/10.1016/j.buildenv.2012.02.024>.
- 813 [36] R. Djedjig, R. Belarbi, E. Bozonnet, Experimental study of green walls impacts on buildings in  
814 summer and winter under an oceanic climate, *Energy Build.* 150 (2017) 403–411.  
815 <https://doi.org/10.1016/j.enbuild.2017.06.032>.
- 816 [37] R. Djedjig, E. Bozonnet, R. Belarbi, Modeling green wall interactions with street canyons for  
817 building energy simulation in urban context, *Urban Clim.* 16 (2016) 75–85.  
818 <https://doi.org/10.1016/j.uclim.2015.12.003>.
- 819 [38] M. Nascimento, J. Gonçalves Pereira, G. Alves Lira, V.D.S.F. Dantas, André A. Nobrega,  
820 Hygrothermal simulation : Use for service life prediction and maintenance of façade, *Eco-  
821 Architecture.* 183 (2019) 139–149. <https://doi.org/doi:10.2495/ARC180131>.
- 822 [39] L.A. De Mello, L.M. Moura, N. Mendes, International Journal of Thermal Sciences A model  
823 for predicting heat , air and moisture transfer through fibrous materials, *Int. J. Therm. Sci.* 145  
824 (2019) 106036. <https://doi.org/10.1016/j.ijthermalsci.2019.106036>.
- 825 [40] R.A. Pescaru, L. Dumitrescu, I. Baran, C.M. Grădinaru, Comparative Analysis of  
826 Hygrothermal Behaviour of the Exterior Walls in Transient Regime, *IOP Conf. Ser. Mater. Sci.  
827 Eng.* 586 (2019). <https://doi.org/10.1088/1757-899X/586/1/012011>.
- 828 [41] F. Tariku, E. Iffa, Empirical model for cavity ventilation and hygrothermal performance  
829 assessment of wood frame wall systems: Experimental study, *Build. Environ.* 157 (2019) 112–  
830 126. <https://doi.org/10.1016/j.buildenv.2019.04.020>.
- 831 [42] H. Rafidiarison, R. Rémond, E. Mougel, Dataset for validating 1-D heat and mass transfer

- 832 models within building walls with hygroscopic materials, *Build. Environ.* 89 (2015) 356–368.  
833 <https://doi.org/10.1016/j.buildenv.2015.03.008>.
- 834 [43] S.K. Asphaug, B. Time, T. Kvande, Hygrothermal simulations of thermally insulated basement  
835 envelopes - Importance of boundary conditions below grade, *Build. Environ.* 199 (2021)  
836 107920. <https://doi.org/10.1016/j.buildenv.2021.107920>.
- 837 [44] French Government, ‘Exigences réglementaires pour la construction des bâtiments’. Ministère  
838 de la Transition écologique et solidaire, 2019. [http://www.ecologique-](http://www.ecologique-solidaire.gouv.fr/exigences-reglementaires-construction-des-batiments.)  
839 [solidaire.gouv.fr/exigences-reglementaires-construction-des-batiments.](http://www.ecologique-solidaire.gouv.fr/exigences-reglementaires-construction-des-batiments.), (n.d.).
- 840 [45] F. Boukhelf, Proposition d’une nouvelle formulation mathématique pour l’analyse du  
841 comportement thermo hydro mécanique des structures fonctionnellement graduées, Thèse de  
842 Doctorat de La Rochelle université, 2020.
- 843 [46] J. Fourier, *Théorie analytique de la chaleur*, 1822, Édouard Leroy, « Sur l’intégration des  
844 équations de la chaleur », 14 (1897) 379–465.
- 845 [47] J. Berger, T. Busser, S. Reddy, G.S. Dulikravich, Evaluation of the reliability of a heat and  
846 mass transfer model in hygroscopic material, *Int. J. Heat Mass Transf.* 142 (2019) 118258.  
847 <https://doi.org/10.1016/j.ijheatmasstransfer.2019.06.014>.
- 848 [48] X. Liu, Y. Chen, H. Ge, P. Fazio, G. Chen, Numerical investigation for thermal performance of  
849 exterior walls of residential buildings with moisture transfer in hot summer and cold winter  
850 zone of China, *Energy Build.* 93 (2015) 259–268.  
851 <https://doi.org/10.1016/j.enbuild.2015.02.016>.
- 852 [49] B. Remki, K. Abahri, M. Tahlaiti, R. Belarbi, Hygrothermal transfer in wood drying under the  
853 atmospheric pressure gradient, *Int. J. Therm. Sci.* 57 (2012) 135–141.  
854 <https://doi.org/10.1016/j.ijthermalsci.2012.02.005>.
- 855 [50] ©COMSOL Introduction to application builder. U.S. Patents, (2016).
- 856 [51] H. Janssen, J. Carmeliet, Hygrothermal simulation of masonry under atmospheric excitation,  
857 *Proc. 3rd Int. Build. Phys. Conf. - Res. Build. Phys. Build. Eng.* (2006) 77–82.
- 858 [52] B. Stute, V. Krupp, E. von Lieres, Performance of iterative equation solvers for mass transfer  
859 problems in three-dimensional sphere packings in COMSOL, *Simul. Model. Pract. Theory.* 33  
860 (2013) 115–131. <https://doi.org/10.1016/j.simpat.2012.10.004>.
- 861 [53] M. Beneš, P. Mayer, Coupled model of hygro-thermal behavior of concrete during fire, *J.*  
862 *Comput. Appl. Math.* 218 (2008) 12–20. <https://doi.org/10.1016/j.cam.2007.04.031>.
- 863 [54] F. Boukhelf, R. Cherif, A. Trabelsi, R. Belarbi, M. Bachir Bouiadjra, On the hygrothermal  
864 behavior of concrete containing glass powder and silica fume, *J. Clean. Prod.* (2021) 128647.  
865 <https://doi.org/10.1016/j.jclepro.2021.128647>.
- 866 [55] EN 12664, Performance thermique des matériaux et produits pour le bâtiment - Détermination  
867 de la résistance thermique par la méthode de la plaque chaude gardée et la méthode  
868 fluxmétrique - Produits secs et humides de moyenne et basse résistance thermique, 2001.
- 869 [56] EN 12667, Performance thermique des matériaux et produits pour le bâtiment - Détermination  
870 de la résistance thermique par la méthode de la plaque chaude gardée et la méthode  
871 fluxmétrique - Produits de haute et moyenne résistance thermique,», 2001.
- 872 [57] NF EN 821-3, Céramiques techniques avancées - Céramiques monolithiques - Propriétés  
873 thermophysiques - Partie 3 : détermination de la chaleur spécifique, Juin 2005, 2005.

- 874 [58] D. Choqueuse, A. Chomard, P. Chauchot, How to provide relevant data for the prediction of  
875 long term behavior of insulation materials under hot/wet conditions?, Offshore Technology  
876 Conference (OTC 16503), Houston, Texas (U.S.A.), 2004., (n.d.).
- 877 [59] ISO 12571, Performance hygrothermique des matériaux et produits pour le bâtiment,  
878 Détermination des propriétés de sorption hygroscopique, 2000.
- 879 [60] S. Furmaniak, A.P. Terzyk, P.A. Gauden, The general mechanism of water sorption on  
880 foodstuffs - importance of the multitemperature fitting of data and the hierarchy of models, *J.*  
881 *Food Eng.* (2007) 528–535.
- 882 [61] H. Yoshino, T. Mitamura, K. Hasegawa, Moisture buffering and effect of ventilation rate and  
883 volume rate of hygrothermal materials in a single room under steady state exterior conditions,  
884 *Build. Environ.* 44 (2009) 1418–1425. <https://doi.org/10.1016/j.buildenv.2008.09.007>.
- 885 [62] H. M. Rafidiarison, Etudes expérimentales des transferts de masse et de chaleur dans les parois  
886 des constructions en bois, en vue de leur modélisation. Applications aux économies d'énergie  
887 et au confort dans l'habitat, Thèse de doctorat, RP2E - Ecole Doctorale Sciences et Ingénierie  
888 des Ressources, Procédés, Produits, Environnement, France., 2012.
- 889 [63] L.F. Hidalgo, M.N. Candido, K. Nishioka, J.T. Freire, G.N.A. Vieira, Natural and forced air  
890 convection operation in a direct solar dryer assisted by photovoltaic module for drying of green  
891 onion, *Sol. Energy.* 220 (2021) 24–34. <https://doi.org/10.1016/j.solener.2021.02.061>.
- 892 [64] A. Chavan, V. Vitankar, A. Mujumdar, B. Thorat, Natural convection and direct type (NCDT)  
893 solar dryers: a review, *Dry. Technol.* (2020) 1–22.  
894 <https://doi.org/10.1080/07373937.2020.1753065>.
- 895 [65] M. Maaroufi, F. Bennai, R. Belarbi, K. Abahri, Experimental and numerical highlighting of  
896 water vapor sorption hysteresis in the coupled heat and moisture transfers, *J. Build. Eng.* 40  
897 (2021) 102321. <https://doi.org/10.1016/j.jobe.2021.102321>.
- 898 [66] R. Rodrigues, S. Gaboreau, J. Gance, I. Ignatiadis, S. Betelu, Reinforced concrete structures: A  
899 review of corrosion mechanisms and advances in electrical methods for corrosion monitoring,  
900 *Constr. Build. Mater.* 269 (2021) 121240. <https://doi.org/10.1016/j.conbuildmat.2020.121240>.
- 901 [67] S.-C. Han, Y. Jo, J.-I. Yun, Chemical degradation of fly ash blended concrete with the seasonal  
902 variation of rainwater in a radioactive waste repository: A thermodynamic modeling approach,  
903 *Cem. Concr. Res.* 141 (2021) 106326. <https://doi.org/10.1016/j.cemconres.2020.106326>.
- 904 [68] C. Carde, R. François, Modelling the loss of strength and porosity increase due to the leaching  
905 of cement pastes, *Cem. Concr. Compos.* 21 (1999) 181–188. [https://doi.org/10.1016/S0958-](https://doi.org/10.1016/S0958-9465(98)00046-8)  
906 [9465\(98\)00046-8](https://doi.org/10.1016/S0958-9465(98)00046-8).
- 907 [69] H. Jin, J. Liu, Z. Jiang, H. Zhou, J. Liu, Influence of the rainfall intensity on the chloride ion  
908 distribution in concrete with different levels of initial water saturation, *Constr. Build. Mater.*  
909 281 (2021) 122561. <https://doi.org/10.1016/j.conbuildmat.2021.122561>.
- 910 [70] Y. Aït Oumeziane, S. Moissette, M. Bart, F. Collet, S. Pretot, C. Lanos, Influence of hysteresis  
911 on the transient hygrothermal response of a hemp concrete wall, *J. Build. Perform. Simul.* 10  
912 (2017) 256–271. <https://doi.org/10.1080/19401493.2016.1216166>.
- 913 [71] A. Boudenne, L. Ibos, Y. Candau, Analysis of uncertainties in thermophysical parameters of  
914 materials obtained from a periodic method, *Meas. Sci. Technol.* 17 (2006) 1870–1876.  
915 <https://doi.org/10.1088/0957-0233/17/7/027>.
- 916 [72] M. Bart, S. Moissette, Y. Ait Oumeziane, C. Lanos, Transient hygrothermal modelling of  
917 coated hemp-concrete walls, *Eur. J. Environ. Civ. Eng.* 18 (2014) 927–944.

918 <https://doi.org/10.1080/19648189.2014.911122>.

919