



HAL
open science

Deletion of the carboxyl-terminal transactivation domain of MGF-Stat5 results in sustained DNA binding and a dominant negative phenotype

R Moriggl, V Gouilleux-Gruart, R Jähne, S Berchtold, C Gartmann, X Liu, L Hennighausen, A Sotiropoulos, B Groner, F Gouilleux

► To cite this version:

R Moriggl, V Gouilleux-Gruart, R Jähne, S Berchtold, C Gartmann, et al.. Deletion of the carboxyl-terminal transactivation domain of MGF-Stat5 results in sustained DNA binding and a dominant negative phenotype. *Molecular and Cellular Biology*, 1996, 16 (10), pp.5691-5700. <10.1128/MCB.16.10.5691>. <hal-03411281>

HAL Id: hal-03411281

<https://hal.science/hal-03411281v1>

Submitted on 2 Nov 2021

HAL is a multi-disciplinary open access archive for the deposit and dissemination of scientific research documents, whether they are published or not. The documents may come from teaching and research institutions in France or abroad, or from public or private research centers.

L'archive ouverte pluridisciplinaire **HAL**, est destinée au dépôt et à la diffusion de documents scientifiques de niveau recherche, publiés ou non, émanant des établissements d'enseignement et de recherche français ou étrangers, des laboratoires publics ou privés.



HAL Authorization

Deletion of the Carboxyl-Terminal Transactivation Domain of MGF-Stat5 Results in Sustained DNA Binding and a Dominant Negative Phenotype

RICHARD MORIGGL,¹ VALERIE GOUILLEUX-GRUART,² RUTH JÄHNE,¹ SUSANNE BERCHTOLD,¹
CHRISTOPH GARTMANN,³ XIUWEN LIU,⁴ LOTHAR HENNIGHAUSEN,⁴
ATHANASSIA SOTIROPOULOS,⁵ BERND GRONER,^{1*} AND FABRICE GOUILLEUX¹

Tumor Biology Center, Institute for Experimental Cancer Research, and Department of Biology, University of Freiburg, 79106 Freiburg,¹ and Max Planck Institute for Immunobiology, 79108 Freiburg,³ Germany; Laboratory of Immunology, Centre Hospitalier d'Amiens, 80000 Amiens,² and Institut National de la Santé et de la Recherche Médicale U344, Faculté de Médecine Necker-Enfants malades, 75730 Paris Cédex 15,⁵ France; and Laboratory of Biochemistry and Metabolism, National Institute of Diabetes and Digestive and Kidney Diseases, Bethesda, Maryland 20892⁴

Received 12 March 1996/Returned for modification 12 April 1996/Accepted 2 July 1996

The Stat (signal transducer and activator of transcription) factors transmit cytokine, growth factor, and hormone responses. Seven members of the Stat gene family are known. MGF-Stat5a has been discovered as a mediator of the prolactin response in mammary epithelial cells. Two closely related variants of Stat5, Stat5a and Stat5b, are encoded by distinct genes. We examined the functional properties of the carboxyl termini of these molecules. Wild-type Stat5a (794 amino acids) and the carboxyl-terminal deletion mutant Stat5a Δ 772 supported prolactin-induced transcription of a β -casein promoter-reporter construct in COS7 cells; Stat5a Δ 750 did not. Upon prolactin activation, tyrosine phosphorylation and the specificity of DNA binding were indistinguishable among the three Stat5a variants. Tyrosine dephosphorylation and the downregulation of the DNA-binding activity were delayed in the Stat5a Δ 750 mutant. The carboxyl-terminal transactivation domain of Stat5a, amino acids 722 to 794, can be conferred to the DNA-binding domain of the yeast transcription factor GAL4. Coexpression of Stat5a or Stat5b and of the carboxyl-terminal deletion mutants resulted in the suppression of transcriptional induction in COS or Ba/F3 cells. We propose that Stat5a Δ 750 and Stat5b Δ 754 are lacking functional transactivation domains and exert their dominant negative effects by blocking the DNA-binding site in Stat5-responsive gene promoters.

The Jak-Stat pathway relays cytokine and growth factor signals from the cell surface to the nucleus (19, 20, 36). Jak (Janus kinase) factors are a family of receptor-associated tyrosine kinases. Stat (signal transducer and activator of transcription) factors are transcription factors regulated by Jak-catalyzed phosphorylation events. The Stat gene family contains seven members which share structural similarities.

First insights have been gained into the domain structure of the Stat factors. A distinctive feature of the Stat factors is an SH2 domain, a phosphotyrosine-binding domain. It mediates specific interactions of the Stat factors with the cytoplasmic region of cytokine receptors (14, 16, 45) and is required for Stat dimerization (43). Stat dimers translocate to the nucleus and bind to specific DNA sequences in the promoters of responsive genes. The use of chimeric Stat1-Stat3 or Stat1-Stat6 fusion molecules led to the identification of a DNA-binding domain. It is localized in a region between amino acid positions 400 and 500, distinct from the SH3 and SH2 domains (17, 38).

The slightly different sequences of the Stat DNA-binding motifs, their arrangement in the promoter regions of individual genes, and the properties of the Stat dimers are determinants of the specificity of transcriptional regulation (23, 38, 42). Selective recruitment of Stats to the receptor, specificity of Stat DNA binding, and specific transactivation properties are mechanisms by which a specific cytokine response is elicited.

Alignments show that sequence diversity among members of

the Stat family is most pronounced in the carboxyl-terminal region. In addition, splice variants of Stat1 α and Stat3 α (referred to as Stat1 β and Stat3 β , respectively) have been detected. These variants exhibit truncations in their C-terminal domains. Stat complexes with different transactivation and DNA-binding properties result (35, 37, 44). A close homolog of mammalian Stat proteins was found in *Drosophila melanogaster*. The *Drosophila* protein marelle exhibits 37% sequence homology to Stat5 and 35% sequence homology to Stat6 (18, 49).

In addition to tyrosine phosphorylation, which regulates DNA binding, serine phosphorylation is involved in the control of Stat activity. It is required for maximal transcriptional activity of Stat1 α and Stat3 α and for the formation of stable Stat3 α homodimer-DNA complexes (50, 52). The phosphorylation sites are located in the carboxyl-terminal region of Stat1 α and Stat3 α . These serine residues are absent in Stat1 β and Stat3 β , which might explain their distinct properties. Cytokines like gamma interferon, beta interferon, and interleukin-6 (IL-6) and growth factors like platelet-derived growth factor are capable of inducing serine phosphorylation of Stat1 α and Stat3 α via the mitogen-activated protein (MAP) kinase pathway (5, 50).

Stat5a was discovered as a regulator of the β -casein gene promoter and mediator of prolactin action in mammary epithelial cells; it was originally called mammary gland factor (39, 40, 46, 48). Stat5b has been detected in hematopoietic cells, mammary gland, and liver tissue (2, 26, 28, 32). Stat5a and Stat5b also differ in their carboxyl-terminal region. Both variants are able to confer the prolactin response to the β -casein

* Corresponding author. Mailing address: Institute for Experimental Cancer Research, Tumor Biology Center, Breisacher Str. 117, D-79106 Freiburg, Germany. Phone: (49) 761 206 1600. Fax: (49) 761 206 1599.

gene promoter (13, 26). The role of Stat5 is not restricted to mammary epithelial cells. Activation of Stat5 also occurs in response to IL-3, IL-5, granulocyte-macrophage colony-stimulating factor, growth hormone, thrombopoietin, erythropoietin, epidermal growth factor, IL-2, IL-7, and IL-15 (2, 11, 12, 21, 24, 28, 29, 33, 47, 51). Whether these cytokines activate Stat5a or Stat5b is not yet known. The activation of Stat5 by these various cytokines suggests that it might be involved in the regulation of differentiation events as well as cell growth.

Attempts have been made to define the role of Stat5 in the cytokine signal transduction cascades. For this purpose, Stat5 docking sites in the intracellular domains of cytokine receptors have been mutated. Stat5 DNA-binding activity is, for example, activated through the β chain of the IL-2 receptor (8). Deletion of the carboxyl-terminal domain of this chain prevented Stat5 activation but does not seem to be essential for IL-2-induced proliferation (7). Others, however, found a decrease in the growth responsiveness of these cells to IL-2 (25). Similar results were obtained when the erythropoietin responsiveness of FDC-P1 cells transfected with erythropoietin receptor variants was investigated. The elimination of the tyrosine residues in the intracellular domain of the receptor resulted in a strongly reduced activation of Stat5 and a decreased growth stimulus (4, 10).

Specific inhibitors of Stat5a- and Stat5b-regulated gene transcription are required to gain insights into their biological roles. In the course of our work on the domain structure of Stat5, we have derived dominant negative variants. We investigated the transactivation properties of the carboxyl-terminal region of Stat5a and Stat5b. Deletions were introduced in this region and analyzed with respect to their effects on the DNA-binding ability and the transactivation potential in COS7 cells and in the hematopoietic cell line Ba/F3. The region between amino acids 750 and 794 contains a weak, conferable transactivation domain and exhibits a regulatory function in the downregulation of the DNA-binding activity of Stat5a. We ascribe the dominant negative properties of Stat5a Δ 750 and Stat5b Δ 754 to their impaired downregulation of DNA binding and blocking of the DNA-binding sites in the promoter regions of Stat5-responsive genes.

MATERIALS AND METHODS

Cell culture and transfections. COS7 cells were maintained in Dulbecco's modified Eagle's medium containing 10% fetal calf serum and 2 mM glutamine and were transfected and induced as described previously (13). The murine pro-B-cell line Ba/F3, stably transfected with the prolactin receptor, was cultured in RPMI 1640 medium containing 2 mM glutamine, 10% fetal calf serum, and 10 ng of prolactin per ml or 10 U of IL-3 per ml. Before induction with prolactin or IL-3, the cells were starved for 4 h in medium containing 3% horse serum and then stimulated with 1 μ g of prolactin per ml or 100 U of IL-3 per ml for the times indicated. COS7 cells were transfected by the calcium phosphate method as described previously (46). For the transfection experiments, 0.2 μ g of expression vectors, 0.5 μ g of the luciferase constructs, and 0.2 μ g of pCH110 were used. Ba/F3 cells were electroporated with a Bio-Rad gene pulser at 250 V and 960 μ F.

Plasmids and DNA transfections. (i) **Stat5 deletion mutants and luciferase reporter constructs.** The (-344 to -1) β -casein gene promoter-luciferase construct, the expression vectors for MGF-Stat5a (pXM-MGF), m-Stat5a (pXM-Stat5a), and m-Stat5b (pXM-Stat5b), and the long form of the murine prolactin receptor have been described previously (26, 46). The mutants MGF-Stat5a Δ 772 and MGF-Stat5a Δ 750 were constructed by the introduction of stop codons with a mutagenesis kit from Promega. The constructs encoding m-Stat5a Δ 749, m-Stat5a2, and m-Stat5b Δ 754 were derived by deleting the regions between the unique *Xho*I (nucleotide 1633) and *Spe*I for pXM-Stat5a or *Eco*RI for pXM-Stat5b adjacent to the stop codon and ligation to PCR-generated fragments. The PCR upper primer comprised conserved nucleotides 1625 to 1650 containing a *Xho*I site. The PCR lower primer comprised a unique *Xba*I site for m-Stat5a Δ 749, m-Stat5a2, and a unique *Eco*RI site for m-Stat5b Δ 754 introduced adjacent to the stop codon. The aspartic acid residue at position 740 of m-Stat5a was changed to a lysine (AAC \rightarrow AAA). Plasmid LHRR contains six copies of the MGF-Stat5-binding site linked to a thymidine kinase minimal promoter and the

luciferase gene (provided by A. Sotiropoulos and J. Fidinori, Paris, France). pCH110 was purchased from Pharmacia.

(ii) **GAL4 DNA-binding domain constructs.** Expression vectors for Gal4 and (Gal4) \times 6-TK-luc were provided by R. Schüle, Freiburg, Germany. Stat5 carboxyl-terminal fragments were generated by PCR and cloned into the expression vector encoding the DNA-binding domain of the protein Gal4 (amino acids 1 to 147) (34). The cDNA fragments of MGF-Stat5a were PCR generated with downstream primers containing a unique *Eco*RI site and upstream primers containing unique *Bam*HI sites flanking amino acid positions 722 to 794, 722 to 750, 742 to 794, 722 to 772, and 742 to 772. The correct nucleotide sequences of the PCR products and cloning junctions were verified by DNA sequencing with the dideoxy T7 DNA-sequencing kit (Pharmacia).

Antibodies and immunoblotting analysis. The antiserum against Stat5 was generated in rabbits by using the fragment from amino acids 350 to 480 of human Stat5a as an antigen. The fragment was produced in bacteria as a glutathione-S-transferase fusion protein. Rabbit antisera against m-Stat5a and m-Stat5b were generated against amino acids 774 to 794 of m-Stat5a and amino acids 776 to 786 of m-Stat5b (26), respectively. The phosphotyrosine antibody (PY20) was purchased from Transduction Laboratories. Immunoreactive bands were visualized with an epichemiluminescence Western blotting (immunoblotting) system (Amersham) as specified by the manufacturer.

Preparation of nuclear extracts and electrophoretic mobility shift assays. Whole-cell extracts were prepared by suspending cell pellets in a buffer containing 400 mM NaCl, 50 mM KCl, 20 mM *N*-2-hydroxyethylpiperazine-*N'*-2-ethanesulfonic acid (HEPES; pH 7.9), 1 mM EDTA, 20% glycerol, 1 mM dithiothreitol, 0.2 mM phenylmethylsulfonyl fluoride, 5 μ g of leupeptin per ml, 5 μ g of aprotinin per ml, 100 μ M sodium orthovanadate, and 20 μ M phenylarsine oxide (PAO). After three freeze-thaw cycles, the cells were centrifuged at 20,800 \times *g* for 15 min at 4°C and the supernatants were recovered for the bandshift or Western blotting experiments. The protocol for the bandshift assays has been described previously (48). In all bandshift experiments, the MGF-Stat5-binding site of the bovine β -casein promoter (5'-AGATTCTAGGAATTCAATC-3') was used as the probe. This oligonucleotide was end labeled with polynucleotide kinase to a specific activity of 8,000 cpm/fmol.

Sequence analysis. Programs used to predict the secondary structure of the carboxyl-terminal region of Stat5a and Stat5b were from the Wisconsin Package of the Genetics Computer Group (program manual, version 8.1, September 1994), and the prediction method of Garnier et al. (9) was used. The program HELICALWHEEL was used to draw the amphipathic α -helix. Sequence alignments were performed with PILEUP. The isoelectric point was estimated with MacDNASIS Pro (version 3). The following sequences (GenBank accession numbers in parentheses) were used: h-Stat5a (L41142), MGF-Stat5a (X78428), m-Stat5a (U21103), r-Stat5a (U24175), m-Stat5b (U21110), and r-Stat5b (X91988).

RESULTS

Transactivation potential of Stat5a, Stat5b, and carboxyl-terminal deletion mutants. The wild-type version of sheep Stat5a, referred to as MGF-Stat5a, comprises 794 amino acids, and the mouse homolog (m-Stat5a) has 793 amino acids. Deletion mutants of MGF-Stat5a and m-Stat5a were derived by the introduction of stop codons in the reading frame of the gene at amino acids 772 and 750 and amino acid 749, respectively. m-Stat5b, which comprises 786 amino acids, was truncated after amino acid 754 (Fig. 1). m-Stat5a2 is a naturally occurring splice variant deleted in mammary tissue (22). The transactivation properties of Stat5 and its variants were studied.

MGF-Stat5a, m-Stat5b, the deletion constructs MGF-Stat5a Δ 772, MGF-Stat5a Δ 750, and m-Stat5b Δ 754, the prolactin receptor, and the β -casein gene promoter-luciferase constructs were introduced in COS7 cells. Luciferase activities were measured in extracts of cells cultured in the absence and presence of prolactin (Fig. 2A). Induction of luciferase activities was observed in cells transfected with MGF-Stat5a, MGF-Stat5a Δ 772, and m-Stat5b (Fig. 2A, lanes 4, 6, and 10) but not in cells transfected with MGF-Stat5a Δ 750 or m-Stat5a Δ 754 (lanes 8 and 12). We repeatedly observed that the luciferase activity in cells transfected with MGF-Stat5a Δ 750 or m-Stat5b Δ 754 and treated with prolactin (lanes 8 and 12) was lower than in cells not treated with prolactin (lanes 7 and 11), indicating an inhibitory effect on the basal promoter activity. Our results show that the carboxyl-terminal regions, from amino acids 750 to 772 in MGF-Stat5a and amino acids 754 to

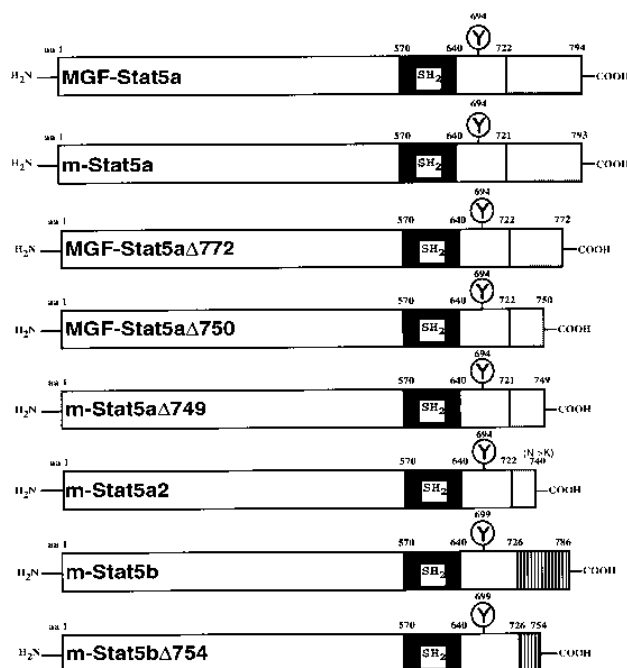

FIG. 1. Schematic structure of MGF-Stat5a, m-Stat5a, m-Stat5b, and the carboxyl-terminal deletion mutants used in this study. MGF-Stat5a refers to the sheep homolog of Stat5a; m-Stat5a and m-Stat5b refer to the mouse homologs of Stat5a and Stat5b. Amino acid (aa) positions, the SH2 domains, and the tyrosine residues (Y) whose phosphorylation is crucial for dimerization and DNA binding are indicated. The aspartic acid residue at position 740 of m-Stat5a was changed to a lysine for the derivation of m-Stat5a2.

786 in m-Stat5b, are indispensable for prolactin-induced transactivation. The amino acids extending beyond 772 in MGF-Stat5a seem not to be essential.

MGF-Stat5a and m-Stat5b can transactivate a reporter construct with multimerized Stat5-binding sites in its promoter region. The β -casein gene promoter has a modular design and contains binding sites for a number of transcription factors (1, 15, 27, 40). To further investigate the potential of the individual domains of Stat5, we analyzed their effects on a simplified promoter structure. A minimal TK-promoter was linked to six copies of the Stat5 response element of the β -casein promoter (Stat5-RE)₆. This promoter was connected to the luciferase gene. COS7 cells were transfected with (Stat5-RE)₆-luc, the prolactin receptor, and the Stat5 variants. After prolactin induction, cell extracts were prepared and luciferase activities were determined (Fig. 2B). A threefold prolactin induction of (Stat5-RE)₆-luc was observed in cells transfected with MGF-Stat5a, m-Stat5b, and MGF-Stat5a Δ 772 (Fig. 2B, lanes 2, 4, and 8). No induction was conferred by MGF-Stat5a Δ 750 and m-Stat5b Δ 754 (lanes 6 and 10); on the contrary, the luciferase activities in presence of prolactin were consistently slightly lower (lanes 5 and 6, 9 and 10).

These results complement the observations made with the β -casein gene promoter. They indicate that Stat5 can act as an autonomous transcription factor which contains a transactivation domain in addition to its DNA-binding function. MGF-Stat5a Δ 750 and m-Stat5b Δ 754 are unable to induce the β -casein- or the (Stat5-RE)₆-containing promoter and are most probably defective in their transactivation functions.

The carboxyl-terminal deletion mutants of Stat5a and Stat5b exhibit impaired downregulation and sustained DNA-binding activities. We investigated the mechanism for the loss

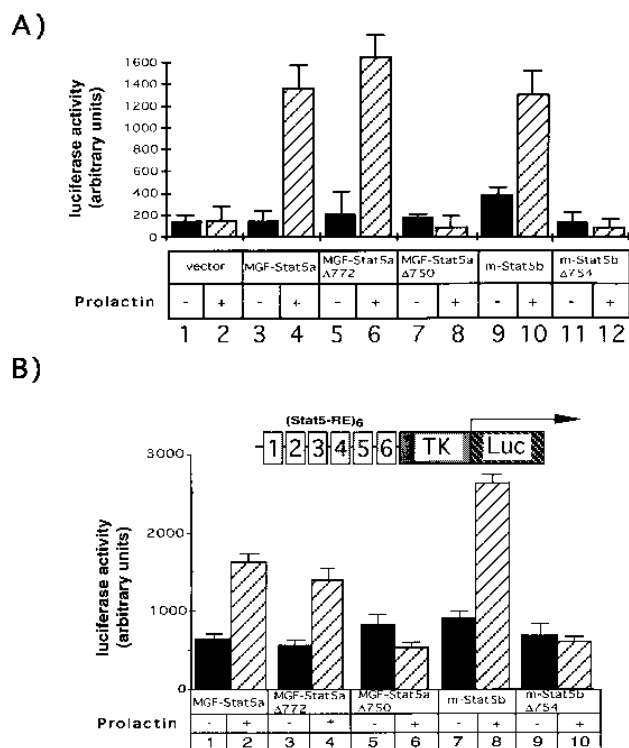

FIG. 2. Transactivation potential of MGF-Stat5a, m-Stat5a, m-Stat5b, and the carboxyl-terminal deletion mutants. (A) COS7 cells were cotransfected with a β -casein-luciferase reporter gene, the prolactin receptor, and the Stat5 variants. A constitutively expressed β -galactosidase gene was included in the transfection to monitor transfection efficiency. Transfected cells were treated for 10 h with prolactin, cell extracts were prepared, and luciferase activities were determined. The values obtained were normalized to the β -galactosidase activities. Five individual experiments were carried out. (B) COS7 cells were transfected with the prolactin receptor, the Stat5 variants indicated, a (Stat5-RE)₆-TK-luc construct containing six Stat5-binding sites in addition to the TK minimal promoter, and a β -galactosidase gene. Luciferase activities were determined in extracts from nonstimulated or prolactin-stimulated cells. Luciferase activities were determined and normalized to the β -galactosidase activities. Five independent experiments were carried out.

of the transactivation potential of MGF-Stat5a Δ 750 and m-Stat5b Δ 754. Prolactin-induced phosphorylation on tyrosine 694 of MGF-Stat5a is required for specific DNA binding (13). An equivalent tyrosine residue is present in the sequence of m-Stat5b at amino acid 699. These tyrosines are retained in the deletion mutants. The possibility that prolactin-induced phosphorylation and the regulation of DNA binding are affected in the deletion mutants cannot be excluded. For this reason, we analyzed these parameters in Stat5a, Stat5b, and its variants.

Nuclear extracts were prepared from COS7 cells transfected with the prolactin receptor, MGF-Stat5a, m-Stat5b, or the variants, and bandshift experiments were carried out with a probe derived from the rat β -casein promoter (Fig. 3A). Specific DNA-binding activities were observed with extracts from the cells transfected with the different variants and induced with prolactin for 1 h (Fig. 3A, lanes 2, 4, 6, 8, and 10). The signals obtained with MGF-Stat5a Δ 750 and m-Stat5b Δ 754 (lanes 6 and 10) were stronger than the ones obtained with the wild-type versions or the deletion mutant MGF-Stat5a Δ 772 (lanes 2, 4, and 8).

The comparison of the DNA-binding activities of MGF-Stat5a, m-Stat5b, MGF-Stat5a Δ 772, MGF-Stat5a Δ 750, and m-Stat5b Δ 754 (Fig. 3A) indicated that differences in the DNA-binding efficiencies might exist. To further study this notion, we

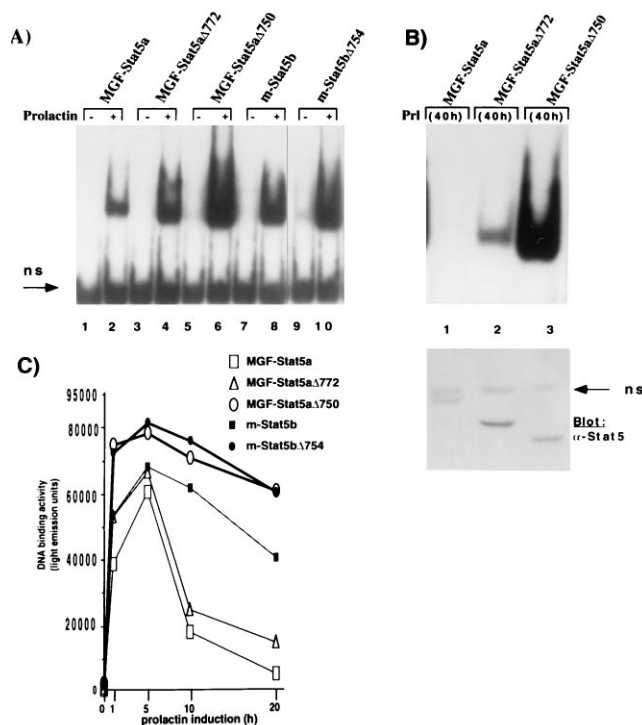

FIG. 3. DNA-binding activities of Stat5 variants in transfected COS cells treated with prolactin. (A) COS7 cells were transfected with the prolactin receptor and the Stat5 constructs. Whole-cell extracts were prepared from non-stimulated cells or cells treated for 1 h with prolactin. Bandshift experiments were carried out with a radioactive DNA probe comprising the MGF-Stat5a-binding site in the β -casein gene promoter. (B) Autoradiograph of a bandshift experiment with whole-cell extracts from transfected COS7 cells induced for 40 h with prolactin. Stimulated COS7 cells were introduced in bandshift assays with the β -casein oligonucleotide probe (upper panel). The amount of Stat5 in the whole-cell extracts was determined by Western blotting with a Stat5-specific antiserum (lower panel; ns indicates a nonspecific signal). (C) COS7 cells were transfected with the Stat5 variants indicated and the prolactin receptor. They were treated with prolactin for 1, 5, 10, or 20 h. Whole-cell extracts were prepared, and the proteins were introduced in bandshift assays. The bandshift signals were scanned and quantitated with a scanner (Molecular Dynamics). Two individual experiments were carried out.

analyzed the DNA binding of the Stat5 variants as a function of time.

The Stat5 variants, the prolactin receptor, and the β -casein gene promoter-luciferase construct were transfected into COS7 cells. Nuclear extracts were prepared from cells treated for 1, 5, 10, 20, and 40 h with prolactin. Bandshift experiments were carried out and quantitated (Fig. 3B and C). The DNA-binding activities of all Stat5 variants were activated by prolactin and reached a maximum after 1 to 5 h (Fig. 3C). Stronger maximal signals were obtained with the deletion mutants MGF-Stat5a Δ 750 and m-Stat5b Δ 754 than with the wild-type molecule MGF-Stat5a. Stat5b has an intermediate DNA-binding activity. The DNA-binding activities of MGF-Stat5a and MGF-Stat5a Δ 772 were strongly downregulated 5 h after prolactin induction. Very weak downregulation was observed for MGF-Stat5a Δ 750 and m-Stat5b Δ 754. After 40 h of induction, the DNA binding of MGF-Stat5a Δ 750 was still very strong and that of MGF-Stat5a Δ 772 was considerable whereas MGF-Stat5a DNA-binding activity could no longer be detected (Fig. 3B).

The differences in the signals observed in Fig. 3B are not due to different stabilities of the variant Stat5 molecules. Western blotting analysis shows that MGF-Stat5a (lane 1), MGF-

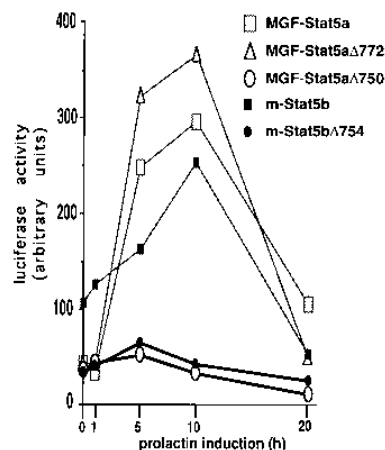

FIG. 4. Time course of transcription in COS cells transfected with Stat5 variants. COS7 cells were transfected with the Stat5 variants indicated, the prolactin receptor, a β -casein-luciferase gene, and a β -galactosidase gene under the control of a simian virus 40 promoter. They were treated with prolactin for 1, 5, 10 or 20 h. Extracts were prepared, and luciferase and β -galactosidase activities were determined. The ratios of the luciferase to β -galactosidase activities are shown. Two independent experiments were carried out.

Stat5a Δ 772 (lane 2), and MGF-Stat5a Δ 750 (lane 3) were present at similar levels after 40 h of induction. These results indicate that the carboxyl-terminal regions of MGF-Stat5a confer signals for the downregulation of the DNA binding.

Kinetics of transcription of the β -casein gene promoter-luciferase construct upon prolactin induction of transfected COS7 cells. We measured the luciferase activity after different times of prolactin induction in cells transfected with the Stat5 variants, the prolactin receptor, and the β -casein gene promoter-luciferase construct. A β -galactosidase gene was included in the transfection, and β -galactosidase activity served as a control for the transfection efficiency. We expressed the relative luciferase activity as the ratio of luciferase to β -galactosidase activity (Fig. 4).

Consistent with the results shown in Fig. 1B, MGF-Stat5a Δ 750 and m-Stat5b Δ 754 cannot transactivate the β -casein gene promoter, despite their strong and persistent DNA-binding activity. Transactivation was observed with MGF-Stat5a, m-Stat5b, or the deletion mutant MGF-Stat5a Δ 772. A maximum in the luciferase/ β -galactosidase ratio was reached 10 h after the onset of induction. The ratio then declined as a result of the downregulation of the DNA-binding activities of MGF-Stat5a, m-Stat5b, and MGF-Stat5a Δ 772 and the continuing transcription of the β -galactosidase gene. These results indicate that the DNA-binding activities of MGF-Stat5a, m-Stat5b, and MGF-Stat5a Δ 772 parallel their transactivation potentials; i.e., efficient transcription requires the persistent binding of the factors to the promoter region.

Tyrosine phosphorylation persists in carboxyl-terminally truncated Stat5 variants. We investigated the tyrosine phosphorylation state of Stat5 variants in prolactin-treated, transfected COS7 cells. For this purpose, the proteins were analyzed by sodium dodecyl sulfate (SDS)-gel electrophoresis and visualized with a phosphotyrosine-specific antibody, PY20 (Fig. 5). m-Stat5a, m-Stat5b, and their derivatives m-Stat5a Δ 749 and m-Stat5b Δ 754 were tyrosine phosphorylated in response to prolactin. Maximal phosphorylation was observed within 1 h (Fig. 5, lanes 2 and 8). The tyrosine phosphorylation of m-Stat5a declined after 1 h (Fig. 5A, lanes 3 to 6). The tyrosine phosphorylation of m-Stat5a Δ 749 and m-Stat5b Δ 754

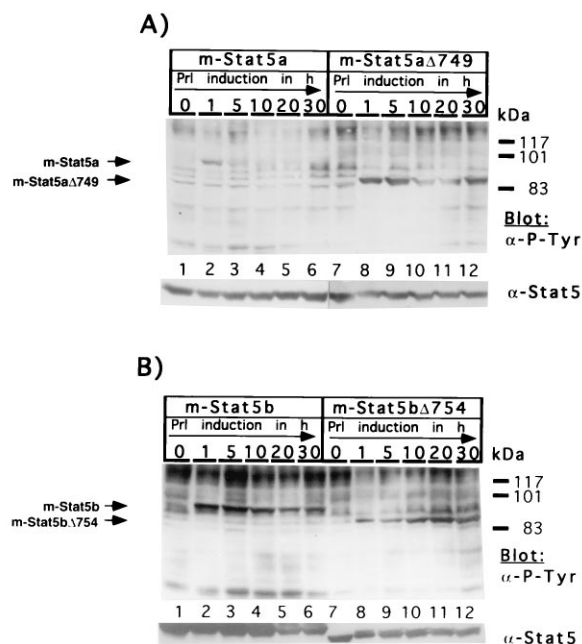

FIG. 5. Tyrosine phosphorylation of m-Stat5a, m-Stat5a Δ 749, m-Stat5b, and m-Stat5b Δ 754. COS7 cells were cotransfected with the prolactin receptor, the Stat5 variants, and the β -galactosidase gene. Whole-cell extracts were prepared after different times of prolactin (PrI) induction. The proteins were separated by SDS-gel electrophoresis, blotted, and probed with a phosphotyrosine-specific antibody (α -P-Tyr [upper panels]). The membranes were reprobed with a polyclonal rabbit antiserum specific for Stat5a and Stat5b (α -Stat5 [lower panels]). (A) Western blot analysis of m-Stat5a and m-Stat5a Δ 749. Whole-cell extracts were prepared from nonstimulated cells and cells treated with prolactin for the times indicated. (B) Western blot analysis of m-Stat5b and m-Stat5b Δ 754. Whole-cell extracts were prepared from nonstimulated cells and cells treated with prolactin for the times indicated.

persisted at a high level for 30 h (Fig. 5A, lanes 9 to 12; Fig. 5B, lanes 5 to 12). The tyrosine phosphate content of m-Stat5b (Fig. 5B, lanes 3 to 6) declined more slowly than that in m-Stat5a. A Stat5-specific antibody was used to determine the expression levels in the transfected cells (Fig. 5A and B, lower panel). The Stat5-specific antibody was raised against human Stat5a (amino acids 350 to 480) and recognizes Stat5a and Stat5b from different species. The Stat proteins are expressed at similar levels at all times. These results indicate that the sustained DNA-binding activities of m-Stat5a Δ 749, m-Stat5b Δ 754, and m-Stat5b are due to a lack of dephosphorylation.

Stat5a2 is a variant of Stat5a which has been cloned from mammary tissue (22). This splice variant lacks the carboxyl-terminal 53 amino acids of Stat5a and contains a lysine residue in the last position. We examined the DNA-binding activity and the tyrosine phosphorylation state of m-Stat5a2 in a time course experiment (Fig. 6). Prolactin induced the maximal DNA binding of m-Stat5a2 within 1 h (Fig. 6A, lane 2). The level of DNA binding stayed constantly high for 30 h (lanes 3 to 8). The tyrosine phosphorylation state of m-Stat5a2 was analyzed by Western blotting (Fig. 6B). Prolactin-induced the tyrosine phosphorylation of m-Stat5a2 within 1 h (lane 2), and only a slight decrease could be observed after 30 h (lane 5). These results show that the naturally occurring splice variant Stat5a2 has very similar properties to the deletion mutants m-Stat5a Δ 749 and m-Stat5b Δ 754.

The carboxyl-terminal region of Stat5 contains a transactivation domain. We defined the transactivation potential of the

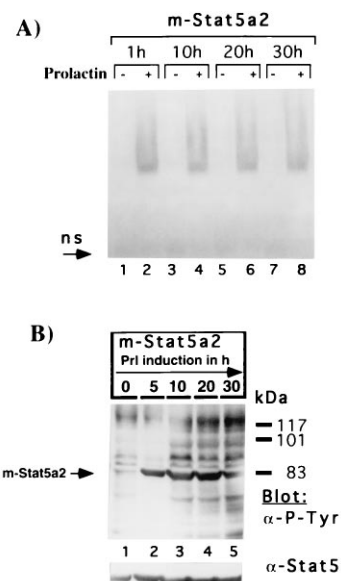

FIG. 6. Tyrosine phosphorylation of m-Stat5a2. COS7 cells were transfected with m-Stat5a2, the prolactin receptor, and the β -galactosidase gene. The cells were induced with prolactin for the times indicated. Whole-cell extracts were prepared. (A) DNA-binding activities of m-Stat5a2. Whole-cell extracts were prepared from nonstimulated cells or cells treated with prolactin. Bandshift experiments were carried out with a radioactive DNA probe comprising the Stat5a-binding site in the β -casein promoter. (B) Western blotting analysis of m-Stat5a2. Whole-cell extracts were prepared from nonstimulated cells or cells treated with prolactin (PrI). The proteins were separated by SDS-gel electrophoresis, blotted, and probed with the phosphotyrosine-specific antibody (α -P-Tyr [upper panel]). The membrane was reprobed with a polyclonal antiserum specific for Stat5a and Stat5b (α -Stat5 [lower panel]).

Stat5 carboxyl-terminal region. Fusion proteins in which the DNA-binding domain of the yeast GAL4 transcription factor was linked to the transactivation domain of Stat5 were constructed (Fig. 7). The GAL4 fusion genes were transfected in COS7 cells. Expression of the GAL4 fusion proteins was analyzed in Western blotting and bandshift experiments. The expected sizes of the fusion proteins were observed (data not shown).

The transactivation potentials of the GAL4 fusion constructs were tested. COS7 and Ba/F3 cells were cotransfected with the GAL4 fusion genes and a luciferase reporter construct with a promoter which contains three binding sites for the GAL4 protein (Fig. 7). GAL4-Stat5a(722–794) enhanced luciferase activity threefold in COS7 and Ba/F3 cells. Similar results have been obtained with constructs containing the carboxyl-terminal region of m-Stat5b (data not shown). Further deletions in the carboxyl-terminal region of Stat5a led to a decrease in the induction of luciferase activity. The regions 722 to 750 and 742 to 772 did not exhibit transactivation functions. The increase in transcriptional activity observed with GAL4-Stat5a(722–794) is consistent with the induction of the luciferase reporter construct containing six copies of Stat5-binding sites (Stat5-RE)₆ in its promoter region shown in Fig. 2B. These results indicate that the carboxyl-terminal region of Stat5a contains a weak transactivation domain.

MGF-Stat5a Δ 750 and m-Stat5b Δ 754 have dominant negative effects on the transcriptional induction by wild-type Stat5. We investigated the effects of the carboxyl-terminal deletion mutants on wild-type MGF-Stat5a function. COS7 cells were cotransfected with the β -casein gene promoter-luciferase construct, the prolactin receptor, MGF-Stat5a, and increasing

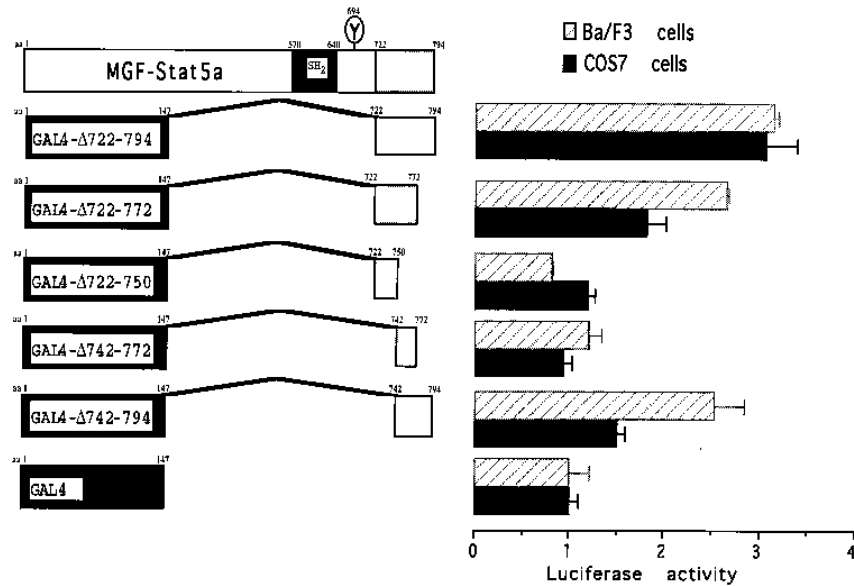

FIG. 7. Delimitation of the transactivation domain of Stat5 by fusion to the DNA-binding domain of the yeast transcription factor GAL4. GAL4-MGF-Stat5a fusions which comprise the DNA-binding and dimerization domain of yeast GAL4 (amino acids 1 to 147) and segments of the carboxyl-terminal region of MGF-Stat5a as indicated were derived. These constructs and a GAL4-luciferase reporter construct were transfected into COS7 or Ba/F3 cells. The luciferase activities were determined. The activity of cells transfected with a construct lacking MGF-Stat5a sequences (GAL4) was set to 1. Six individual experiments were carried out. Y, tyrosine.

amounts of MGF-Stat5aΔ750 (Fig. 8A). MGF-Stat5a by itself mediated a 10-fold induction of luciferase activity upon prolactin stimulation (lanes 1 and 2). The inclusion of MGF-Stat5aΔ750 caused a decrease in the inducibility of luciferase activity. No prolactin induction could be observed when equal amounts of MGF-Stat5a and MGF-Stat5aΔ750 were transfected (lanes 3 to 6). Suppression of MGF-Stat5a activity was not observed when MGF-Stat5aΔ772 was cotransfected (Fig.

8B, lanes 3 and 4). A slight increase in the induction of luciferase activity resulted. The effects of m-Stat5aΔ749 on Stat5b and of m-Stat5bΔ754 on Stat5a were also investigated (Fig. 8C). m-Stat5bΔ754 and m-Stat5aΔ749 were able to exert a dominant negative effect on m-Stat5a and m-Stat5b (lanes 3, 4, 7, and 8) induction of the reporter gene. These results indicated that both deletion mutants can inhibit the activity of Stat5a and Stat5b.

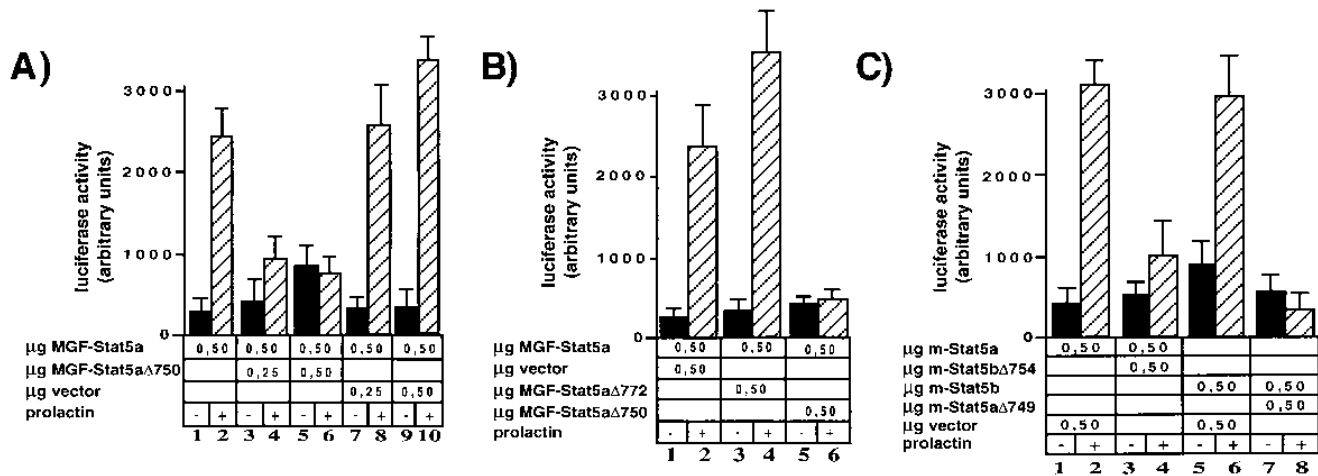

FIG. 8. MGF-Stat5aΔ750, m-Stat5aΔ749, and m-Stat5bΔ754 have dominant negative effects on the transactivation potential of wild-type Stat5a and Stat5b. (A) COS7 cells were transfected with the β -casein gene promoter-luciferase construct, the prolactin receptor, a β -galactosidase gene, and the wild-type MGF-Stat5a. Increasing amounts of the MGF-Stat5aΔ750 construct were added to the cells analyzed in lanes 3 to 6, and vector DNA was added to the cells analyzed in lanes 7 to 10. Luciferase activities were measured in extracts of cells induced or not induced with prolactin. Four independent experiments were carried out. (B) COS7 cells were transfected with the β -casein gene promoter-luciferase construct, the prolactin receptor, a β -galactosidase gene, and wild-type MGF-Stat5a, vector DNA (lanes 1 and 2), MGF-Stat5aΔ772 (lanes 3 and 4) or MGF-Stat5aΔ750 (lanes 5 and 6). Luciferase activities were measured in extracts of cells induced or not induced with prolactin. Three independent experiments were carried out. (C) COS7 cells were transfected with the β -casein gene promoter-luciferase construct, the prolactin receptor, a β -galactosidase gene, and (i) wild-type m-Stat5a, vector DNA (lanes 1 and 2), and m-Stat5bΔ754 (lanes 3 and 4), or (ii) wild-type m-Stat5b, vector DNA (lanes 5 and 6), or m-Stat5aΔ749. Luciferase activities were measured in extracts of cells induced or not induced with prolactin. Three independent experiments were carried out. All luciferase activities are normalized to β -galactosidase activities.

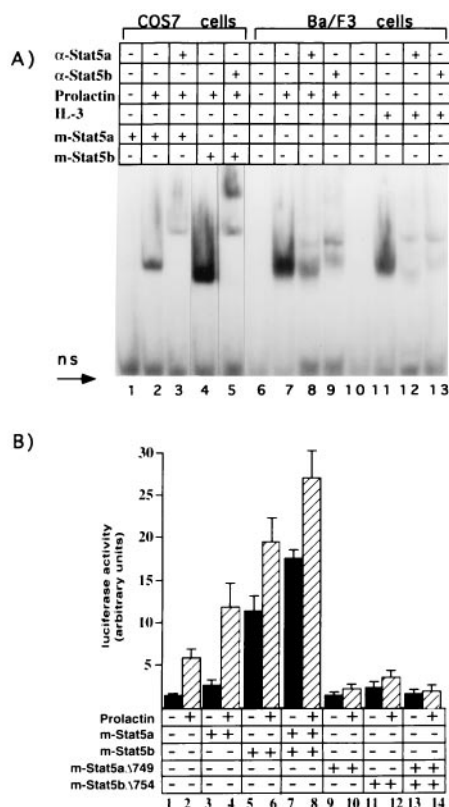

FIG. 9. Suppression of transactivation by Stat5a and Stat5b through dominant negative Stat5 variants in Ba/F3 cells. (A) Stat5a and Stat5b were induced by prolactin or by IL-3 in Ba/F3 cells. COS7 cells were transfected with m-Stat5a or m-Stat5b and induced with prolactin. Ba/F3 cells, stably transfected with the prolactin receptor, were induced with prolactin or with IL-3. Whole-cell extracts were prepared and analyzed by bandshift assays. Specific antisera for m-Stat5a or m-Stat5b were included in the binding reactions. (B) m-Stat5a Δ 749 and m-Stat5b Δ 754 suppress the endogenous Stat5 activity in Ba/F3 cells. Ba/F3 cells, stably expressing the prolactin receptor, were transiently transfected with the (Stat5-RE)6-luciferase construct (lanes 1 and 2) and the m-Stat5a (lanes 3 and 4), m-Stat5b (lanes 5 and 6), m-Stat5a plus mStat5b (lanes 7 and 8), m-Stat5a Δ 749 (lanes 9 and 10), m-Stat5b Δ 754 (lanes 11 and 12), and m-Stat5a Δ 749 plus m-Stat5b Δ 754 (lanes 13 and 14). Cells were treated with prolactin or left untreated, and luciferase activities were determined in cell extracts.

m-Stat5a Δ 749 and m-Stat5b Δ 754 suppress endogenous Stat5 activity in prolactin-induced Ba/F3 cells. Ba/F3 cells are murine pro-B cells which express the IL-3 receptor and are dependent on IL-3 for growth. IL-3 activates endogenous Stat5 or a Stat5-like molecule in these cells. Stable transfection of the prolactin receptor into Ba/F3 cells allows growth in the presence of prolactin (6). Prolactin also induces endogenous Stat5 in transfected Ba/F3 cells (30).

We visualized the presence and the activation of m-Stat5a and m-Stat5b in Ba/F3 cells induced by IL-3 and prolactin (Fig. 9A, lanes 6 to 13). Cells were stimulated with prolactin (lanes 7 to 9) or IL-3 (lanes 11 to 13), whole-cell extracts were prepared, and bandshift assays were carried out. Specific Stat5-DNA complexes were induced by prolactin (lane 7) and IL-3 (lane 11). The presence of Stat5a and Stat5b in the DNA-binding complexes was shown with specific antisera. The specificities of the antisera were verified in supershift experiments with extracts from COS cells transfected with Stat5a or Stat5b (lanes 2 to 5). The presence of Stat5a and Stat5b in Ba/F3 cells and their activation by prolactin and IL-3 were confirmed by partial purification of the molecules (data not shown).

We also examined the effects of m-Stat5a Δ 749 and m-Stat5b Δ 754 on the function of endogenous Stat5 in the induction of the (Stat5-RE)6-luc construct in transiently transfected Ba/F3 cells (Fig. 9B). Endogenous Stat5 caused a three- to fourfold induction of the luciferase activity in prolactin-stimulated cells (Fig. 9B, lanes 1 and 2). Transfection of m-Stat5a caused a twofold increase in both basal and induced luciferase activities (lanes 3 and 4). When m-Stat5b was cotransfected, the basal luciferase activity was 10-fold higher (lane 5) than in cells transfected with the gene reporter construct only. Prolactin further increased the luciferase activity. A synergistic effect on the basal and induced luciferase activities was observed when Stat5a and Stat5b were coexpressed (lanes 7 and 8). Transfection of m-Stat5a Δ 749 or m-Stat5b Δ 754 (lanes 10 and 12) led to reduction in the inducibility of the Ba/F3 cells. When m-Stat5a Δ 749 and m-Stat5b Δ 754 were introduced together into Ba/F3 cells, they blocked the transactivation of the (Stat5-RE)6-regulated promoter (lanes 13 and 14).

DISCUSSION

We investigated the domain structure of Stat5 and found two functions which localize to the carboxyl-terminal region. A transactivation domain is present between amino acids 722 and 794 of MGF-Stat5a. The region between amino acids 750 and 794 regulates the interaction between Stat5a and the DNA response element. Deletion of the carboxyl-terminal region led to a loss of the transactivation potential and to a sustained DNA-binding activity. The downregulation of DNA binding was negatively affected. Delayed dephosphorylation is responsible for the sustained DNA-binding activity. Similar observations were made with the naturally occurring splice variant Stat5a2. The colocalization of the transactivation domain and a region regulating the DNA binding in the carboxyl-terminal region of Stat5 is responsible for the dominant negative effects which carboxyl-terminal deletion mutants exerted over the wild-type molecule.

Variants of Stat5 molecules which differ in their carboxyl-terminal regions have been observed previously. A splice variant of Stat1 α , Stat1 β , lacks the 38 carboxyl-terminal amino acids (37). Stat1 β does not induce the transcriptional activation of genes in response to gamma interferon (43). It was shown very recently that the carboxyl-terminal 50 amino acids of Stat2 are required for the transcriptional activation in response to alpha interferon. Mutants lacking this region cannot stimulate alpha interferon-dependent transcription (31). A splice variant of Stat3 α , Stat3 β , was also recently detected. This protein lacks the carboxyl-terminal 55 amino acids of Stat3 α and has a carboxyl terminus of 7 amino acids not present in Stat3 α . c-Jun cooperates synergistically with Stat3 β in the transcriptional activation of the α_2 -macroglobulin gene promoter, which contains a Stat3-binding site (35). Stat3 β binds Stat3 response elements without activation by a cytokine. The loss of the transactivation potential of Stat1 β indicates the presence of a transactivation domain in the carboxyl-terminal domain of Stat1 α . The altered DNA-binding properties of Stat3 β indicate that this function is regulated by carboxyl-terminal sequences. The properties of these naturally occurring variants of Stat1 α and Stat3 α are reminiscent of the properties of the Stat5 deletion mutants and the spliced form of Stat5a analyzed here. Shorter variants of Stat5 have been found in hematopoietic cells activated with IL-3 (2). Whether or not these short forms represent splice variants or distinct gene products is not yet known. A splice variant of Stat5a which lacks the carboxyl-terminal 54 amino acids has been

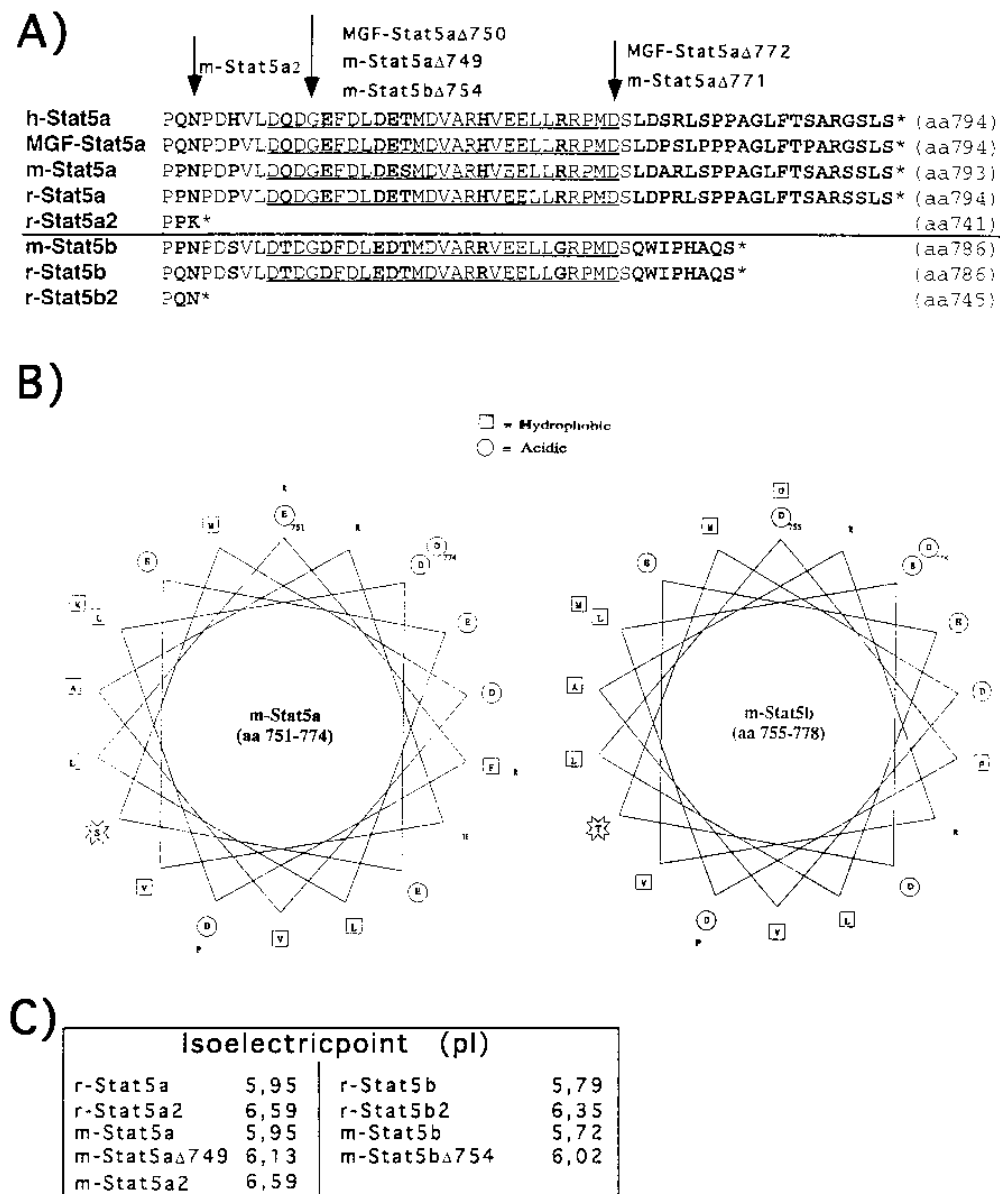

FIG. 10. Sequences and secondary-structure analysis of the carboxyl-terminal domains of Stat5a and Stat5b. (A) Sequence of the carboxyl-terminal 56 amino acids (aa) of human Stat5a (h-Stat5a) (36), sheep Stat5a (MGF-Stat5a) (46), murine Stat5a (m-Stat5a) (26), rat Stat5a (r-Stat5a) (22), murine Stat5b (m-Stat5b) (26), rat Stat5b (r-Stat5b) (32), and two splice variants from rat Stat5a and rat Stat5b (r-Stat5a2 and r-Stat5b2) (22, 32). The carboxyl-terminal 44 amino acids of Stat5b are shown. Differences between Stat5a and Stat5b are shown in boldface type. The underlined sequences could form an α -helical structure. The positions at which stop codons have been introduced in the derivation of the carboxyl-terminal deletion mutants MGF-Stat5a Δ 772, m-Stat5a Δ 771, MGF-Stat5a Δ 750, m-Stat5a Δ 749, m-Stat5a2, and m-Stat5b Δ 754 are indicated by arrows. The sequence of sheep MGF-Stat5a has been corrected. Accession numbers of sequences used for alignment and programs used for secondary-structure predictions are described in Materials and Methods. (B) Projection of the carboxyl-terminal sequence of m-Stat5a and m-Stat5b as a helical wheel. The α -helix is viewed from one end, with the perimeter of a wheel corresponding to the backbone of the carboxyl terminus. Residues are spaced 100° of arc apart to give 3.6 residues per turn. Amino acids with hydrophobic side chains are boxed. Amino acids with hydrophilic side chains are circled. Serine 756 of m-Stat5a and threonine 761 of m-Stat5b are enclosed in star-shaped symbols. (C) Isoelectric points of m-Stat5a, r-Stat5a, r-Stat5a2, m-Stat5a2, r-Stat5b, and m-Stat5b and the deletion mutants m-Stat5a Δ 749 and m-Stat5b Δ 754.

cloned from mRNA of the rat mammary gland (22) (referred to as Stat5a2 in Fig. 10), and a variant of Stat5b which lacks the carboxyl-terminal 41 amino acids has been cloned from mRNA of rat liver nuclei (32) (referred to as Stat5b2 in Fig. 10).

The sequences of Stat5a and Stat5b are conserved to 96% at the amino acid level. Comparison between Stat5a (human, mouse, rat, and sheep) and Stat5b (mouse and rat) shows that the region of the most pronounced sequence diversity is located in the carboxyl-terminal region. Only 55% identity is

found between amino acids 737 and 793 of m-Stat5a and amino acids 742 to 786 of m-Stat5b (Fig. 10A). Secondary-structure predictions (9) indicate that the central part of this region can adopt an α -helical structure (Fig. 10). This sequence is enriched in hydrophobic residues (9 amino acids for Stat5a and 10 amino acids for Stat5b) and acidic residues (8 amino acids for Stat5a and m-Stat5b). When the carboxyl-terminal regions of m-Stat5a (amino acids 750 to 772) and m-Stat5b (amino acids 755 to 777) are plotted as a helical wheel, a cluster of six

acidic residues is found on one face of the wheel and a cluster of eight hydrophobic residues is found on the opposite face (Fig. 10B). Deletion of the carboxyl-terminal region of Stat5 increases the positive net charges of the molecule and leads to an increase in the isoelectric point (Fig. 10C).

The arrangement of the carboxyl-terminal domain is indicative of an amphipathic α -helix. The clusters of hydrophobic amino acids are separated by a serine residue at position 756 in m-Stat5a and a threonine residue at position 761 in m-Stat5b (indicated in Fig. 10B). Acidic α -helices are included in the transactivation domains of other transcription factors, e.g., the p65 subunit of NF- κ B (41). The interpretation of the sequence supports our conclusion that the carboxyl-terminal region of Stat5 encodes a transactivation domain which can be conferred on a heterologous DNA-binding site (GAL4) and which is missing in the MGF-Stat5a Δ 750 and m-Stat5b Δ 754 variants.

The carboxyl-terminal region of Stat5 also is involved in the regulation of the DNA-binding activity. The tyrosine residue at amino acid 694 appears to be the primary regulator of DNA binding (13). We assume that there are additional signals which contribute to the efficiency of DNA binding. The carboxyl-terminal domain of Stat5 accelerates the downregulation of DNA binding through tyrosine dephosphorylation. The mechanisms for the regulation of DNA binding might be different in Stat3 and Stat5. It has been reported that Stat3 α DNA binding is increased after phosphorylation on serine(s) in the carboxyl-terminal region (50, 52), a mechanism similar to that found in other transcription factors. The initial DNA-binding activity upon cytokine induction is not different among the Stat5 variants tested. Differences were found in the downregulation. This process might be regulated by a tyrosine-specific protein phosphatase which dephosphorylates tyrosine 694. It is conceivable that the carboxyl-terminal region might mediate the interaction between the phosphatase and Stat5.

Serine phosphorylation in the carboxyl termini of Stat1 α and Stat3 α increases DNA-binding activity and transactivation potential (50, 52). The phosphorylation has been ascribed to MAP kinases (5, 50). The serine and threonine residues at positions 757 in MGF-Stat5a, 756 in m-Stat5a, and 761 in m-Stat5b, present at similar positions in the projection shown in Fig. 10B, could possibly be phosphorylated. However, they are not part of canonical MAP kinase phosphorylation sites. The sequence context suggests that these residues are phosphorylation sites for casein kinase II. Casein kinase II has previously been reported to increase the DNA-binding activity of MGF-Stat5 (40). These sites might complement the regulation exerted by the phosphorylation of tyrosine 694.

Recently, IL-3 induction of serine and threonine phosphorylation of Stat5 has been found in T cells. This seems to involve a kinase which is different from MAP kinase and S6 kinase (3). The activation of Stat5 is a common event in the signal transduction by different cytokines. The induction of the β -casein gene in mammary epithelial cells is directly linked to Stat5 activation. The role of Stat5 in hematopoietic cells is less well defined. Cytokine receptors, e.g., the IL-3 receptor, not only activate Stat5 but also activate the MAP kinase pathway, phosphoinositol-3-kinase, ribosomal S6-kinase, and Vav and Shc. This makes it difficult to assign specific roles to individual signaling molecules. The dominant negative phenotype of MGF-Stat5a Δ 750 and m-Stat5b Δ 754 will allow the identification of target genes in individual cell types and shed light on the role of Stat5 in the control of cell growth and differentiation.

ACKNOWLEDGMENTS

We thank R. Schüle, E. Greiner, and Jesús Fominaya, Tumor Biology Center, Institute for Experimental Cancer Research, Freiburg, Germany, for gifts of plasmids and reagents and for helpful discussions. We also thank I. Dusanter-Fourt, Paris, France, for providing the Ba/F3 cells expressing the prolactin receptor and Ines Fernandez, Institute for Experimental Cancer Research, for editorial assistance.

REFERENCES

1. Altioik, S., and B. Groner. 1993. Interaction of two sequence-specific single-stranded DNA-binding proteins with an essential region of the β -casein gene promoter is regulated by lactogenic hormones. *Mol. Cell. Biol.* **13**:7303-7310.
2. Azam, M., H. Erdjument-Bromage, B. L. Kreider, M. Xia, F. Quelle, R. Basu, C. Saris, P. Tempst, J. N. Ihle, and C. Schindler. 1995. Interleukin-3 signals through multiple isoforms of Stat5. *EMBO J.* **14**:1402-1411.
3. Beadling, C., J. Ng, J. W. Babbage, and D. A. Cantrell. 1996. Interleukin-2 activation of Stat5 requires the convergent action of tyrosine kinases and a serine/threonine kinase pathway distinct from the Raf1/ERK2 MAP kinase pathway. *EMBO J.* **15**:1902-1913.
4. Damen, J. E., H. Wakao, A. Miyajima, J. Kros, R. K. Humphries, R. L. Cutler, and G. Krystal. 1995. Tyrosine 343 in the erythropoietin receptor positively regulates erythropoietin induced cell proliferation and Stat5 activation. *EMBO J.* **14**:5557-5568.
5. David, M., I. E. Petricoin, C. Benjamin, R. Pine, M. J. Weber, and A. C. Lerner. 1995. Requirement for MAP kinase (ERK2) activity in interferon- α and interferon- γ stimulated gene expression through Stat proteins. *Science* **269**:1721-1723.
6. Dusanter-Fourt, L., O. Muller, A. Ziemiecki, P. Mayeux, B. Drucker, J. Djiane, A. Wilks, A. G. Harpur, S. Fisher, and S. Gisselbrecht. 1994. Identification of Jak protein tyrosine kinases as signaling molecules for PRL. Functional analysis of PRL receptor and PRL-erythropoietin receptor chimera expressed in lymphoid cells. *EMBO J.* **13**:2583-2591.
7. Fuji, H., Y. Nakagawa, U. Schindler, A. Kawahara, H. Mori, F. Gouilleux, B. Groner, J. N. Ihle, Y. Minami, T. Miyazaki, and T. Taniguchi. 1995. Activation of Stat5 by interleukin 2 requires a carboxy-terminal region of the interleukin 2 receptor β chain but is not essential for the proliferative signal transmission. *Proc. Natl. Acad. Sci. USA* **92**:5482-5486.
8. Gaffen, S. L., S. Y. Lai, W. Xu, F. Gouilleux, B. Groner, M. A. Goldsmith, and W. C. Greene. 1995. Signaling through the interleukin 2 receptor β chain activates a Stat5 like DNA binding activity. *Proc. Natl. Acad. Sci. USA* **92**:7192-7196.
9. Garnier, J., D. J. Osguthorpe, and B. Robson. 1978. Analysis of the accuracy and implications of simple methods for predicting the secondary structure of globular proteins. *J. Mol. Biol.* **120**:97-120.
10. Gobert, S., S. Chretien, F. Gouilleux, O. Muller, C. Pallard, I. Dusanter-Fourt, B. Groner, C. Lacombe, S. Gisselbrecht, and P. Mayeux. 1996. Identification of tyrosine residues within the intracellular domain of the erythropoietin receptor crucial for Stat5 activation. *EMBO J.* **15**:2434-2441.
11. Gouilleux, F., D. Moritz, M. Humar, R. Moriggl, S. Berchtold, and B. Groner. 1995. Prolactin and interleukin 2 receptors in T lymphocytes signal through a MGF/Stat5-like transcription factor. *Endocrinology* **136**:5700-5708.
12. Gouilleux, F., C. Pallard, I. Dusanter-Fourt, H. Wakao, L.-A. Haldosen, G. Norstedt, D. Levy, and B. Groner. 1995. Prolactin, growth hormone, erythropoietin and granulocyte-macrophage colony stimulating factor induce MGF-Stat5 DNA binding activity. *EMBO J.* **14**:2005-2013.
13. Gouilleux, F., H. Wakao, M. Mundt, and B. Groner. 1994. Prolactin induces phosphorylation of tyr694 of Stat5(MGF), a prerequisite for DNA binding and induction of transcription. *EMBO J.* **13**:4361-4369.
14. Greenlund, A. C., M. O. Morales, B. L. Viviano, H. Yan, J. Krolewski, and R. D. Schreiber. 1995. Stat recruitment by tyrosine-phosphorylated cytokine receptors: an ordered reversible affinity-driven process. *Immunity* **2**:677-687.
15. Groner, B., and F. Gouilleux. 1995. Prolactin-mediated gene activation in mammary epithelial cells. *Curr. Opin. Gen. Dev.* **5**:587-594.
16. Heim, M. H., I. M. Kerr, G. R. Stark, and J. E. Darnell. 1995. Contribution of Stat SH2 groups to specific interferon signaling by the Jak-Stat pathway. *Science* **267**:1347-1349.
17. Horvarth, C. M., Z. Wen, and J. E. Darnell. 1995. A Stat protein domain that determines DNA sequence recognition suggests a novel DNA-binding domain. *Genes Dev.* **9**:984-994.
18. Hou, X. S., M. B. Melnick, and N. Perrimon. 1996. Marelle acts downstream of the Drosophila HOP/JAK kinase and encodes a protein similar to the mammalian STATs. *Cell* **84**:411-419.
19. Ihle, J. N. 1995. Cytokine receptor signalling. *Nature (London)* **377**:591-594.
20. Ihle, J. N. 1996. Stats: signal transducers and activators of transcription. *Cell* **84**:331-334.
21. Johnston, J. A., C. M. Bacon, D. S. Finbloom, R. C. Rees, D. Kaplan, K. Shibuya, J. R. Ortaldo, S. Gupta, Y. Q. Chen, J. D. Giri, and J. J. O'Shea. 1995. Tyrosine phosphorylation and activation of Stat5, Stat3 and Janus

- kinases by interleukins 2 and 15. *Proc. Natl. Acad. Sci. USA* **92**:8705–8709.
22. Kazansky, A. V., B. Raught, M. Lindsey, Y. Wang, and J. M. Rosen. 1995. Regulation of mammary gland factor/Stat5a during mammary gland development. *Mol. Endocrinol.* **9**:1598–1609.
 23. Lamb, P., H. M. Seidel, J. Haslam, L. Milocco, L. V. Kessler, R. B. Stein, and J. Rosen. 1995. Stat protein complexes activated by interferon- γ and gp130 signaling molecules differ in their sequence preferences and transcriptional induction properties. *Nucleic Acids Res.* **23**:3283–3289.
 24. Lin, J.-X., T.-S. Migone, M. Tsang, M. Friedmann, J. A. Weatherbee, L. Zhou, A. Yamauchi, E. T. Bloom, J. Mietz, S. John, and W. J. Leonard. 1995. The role of shared receptor motifs and common Stat proteins in the generation of cytokine pleiotropy and redundancy by IL-2, IL-4, IL-7, IL-13 and IL-15. *Immunity* **2**:331–339.
 25. Liu, K. D., S. Y. Lai, M. A. Goldsmith, and W. C. Greene. 1995. Identification of a variable region within the cytoplasmic tail of the IL-2 receptor β chain that is required for growth signal transduction. *J. Biol. Chem.* **270**:22176–22181.
 26. Liu, X., G. W. Robinson, F. Gouilleux, B. Groner, and L. Hennighausen. 1995. Cloning and expression of Stat5 and an additional homologue (Stat5b) involved in prolactin signal transduction in mouse mammary tissue. *Proc. Natl. Acad. Sci. USA* **92**:8831–8835.
 27. Meier, V., and B. Groner. 1994. The nuclear factor YY1 participates in repression of the β -casein gene promoter in mammary epithelial cells and is counteracted by mammary gland factor during lactogenic hormone induction. *Mol. Cell. Biol.* **14**:128–137.
 28. Mui, A. L.-F., H. Wakao, A.-M. O'Farrell, N. Harada, and A. Miyajima. 1995. Interleukin-3, granulocyte-macrophage colony stimulating factor and interleukin-5 transduce signals through two Stat5 homologs. *EMBO J.* **14**:1166–1175.
 29. Pallard, C., F. Gouilleux, L. Bénit, L. Cocault, M. Souyri, D. Levy, B. Groner, S. Gisselbrecht, and I. Dusanter-Fourt. 1995. Thrombopoietin activates a Stat5-like factor in hematopoietic cells. *EMBO J.* **14**:2847–2856.
 30. Pallard, C., F. Gouilleux, M. Charon, B. Groner, S. Gisselbrecht, and I. Dusanter-Fourt. 1995. Interleukin-3, erythropoietin and prolactin activate a Stat5-like factor in lymphoid cells. *J. Biol. Chem.* **270**:15942–15945.
 31. Qureshi, S. A., S. Leung, I. M. Kerr, G. R. Stark, and J. E. Darnell. 1996. Function of Stat2 protein in transcriptional activation by alpha interferon. *Mol. Cell. Biol.* **16**:288–293.
 32. Ripberger, J. A., S. Fritz, K. Richter, G. M. Hocke, F. Lottspeich, and G. H. Fey. 1995. Transcription factors Stat3 and Stat5b are present in rat liver nuclei in an acute phase response and bind interleukin 6 response elements. *J. Biol. Chem.* **270**:29998–30006.
 33. Ruff-Jamison, S., K. Chen, and S. Cohen. 1995. Epidermal growth factor induces the tyrosine phosphorylation and nuclear translocation of Stat5 in mouse liver. *Proc. Natl. Acad. Sci. USA* **92**:4215–4218.
 34. Sadowski, I., and M. Ptashne. 1989. A vector for expressing GAL4(1–147) fusions in mammalian cells. *Nucleic Acids Res.* **18**:7593–7599.
 35. Schaefer, T. S., L. K. Sanders, and D. Nathans. 1995. Cooperative transcriptional activity of Jun and Stat3 β , a short form of Stat3. *Proc. Natl. Acad. Sci. USA* **92**:9097–9101.
 36. Schindler, C., and J. E. Darnell. 1995. Transcriptional responses to polypeptide ligands: the Jak-Stat pathway. *Annu. Rev. Biochem.* **64**:621–651.
 37. Schindler, C., X.-Y. Fu, T. Improta, R. Aebersold, and J. E. Darnell. 1992. Proteins of transcription factor ISGF-3: one gene encodes the 91- and 84-kDa ISGF-3 proteins that are activated by interferon- α . *Proc. Natl. Acad. Sci. USA* **89**:7836–7839.
 38. Schindler, U., P. Wu, M. Rothe, M. Brasseur, and S. L. McKnight. 1995. Components of a Stat recognition code: evidence for two layers of molecular selectivity. *Immunity* **2**:689–697.
 39. Schmitt-Ney, M., W. Doppler, R. K. Ball, and B. Groner. 1991. Beta-casein gene promoter activity is regulated by the hormone-mediated relief of transcriptional repression and a mammary-specific nuclear factor. *Mol. Cell. Biol.* **11**:3745–3755.
 40. Schmitt-Ney, M., B. Happ, R. K. Ball, and B. Groner. 1992. Developmental and environmental regulation of a mammary gland specific nuclear factor essential for transcription of the gene encoding beta-casein. *Proc. Natl. Acad. Sci. USA* **89**:3130–3134.
 41. Schmitz, M. L., and P. Baeuerle. 1991. The p65 subunit is responsible for the strong transcription activating potential of NF- κ B. *EMBO J.* **10**:3805–3817.
 42. Seidel, M. H., L. H. Milocco, P. Lamb, J. E. Darnell, R. B. Stein, and J. Rosen. 1995. Spacing of palindromic half sites as a determinant of selective Stat (signal transducers and activators of transcription) DNA binding and transcriptional activity. *Proc. Natl. Acad. Sci. USA* **92**:3041–3045.
 43. Shuai, K., C. M. Horvath, L. H. T. Huang, S. A. Qureshi, D. Cowburn, and J. E. Darnell. 1994. Interferon activation of the transcription factor Stat91 involves dimerization through SH2-phosphotyrosyl peptide interactions. *Cell* **76**:821–828.
 44. Shuai, K., G. R. Stark, I. M. Kerr, and J. E. Darnell. 1993. A single phosphotyrosine residue of Stat91 required for gene activation by interferon- γ . *Science* **261**:1808–1812.
 45. Stahl, N., T. J. Farruggella, T. G. Boulton, Z. Zhong, J. E. Darnell, and G. D. Yancopoulos. 1995. Choice of Stats and other substrates specified by modular tyrosine-based motifs in cytokine receptors. *Science* **267**:1349–1352.
 46. Wakao, H., F. Gouilleux, and B. Groner. 1994. Mammary gland factor (MGF) is a novel member of the cytokine regulated transcription factor gene family and confers the PRL response. *EMBO J.* **13**:2182–2191.
 47. Wakao, H., N. Harada, T. Kitamura, A. L.-F. Mui, and A. Miyajima. 1995. Interleukin 2 and erythropoietin activate Stat5/MGF via distinct pathways. *EMBO J.* **14**:2527–2535.
 48. Wakao, H., M. Schmitt-Ney, and B. Groner. 1992. Mammary gland-specific nuclear factor is present in lactating rodent and bovine mammary tissue and composed of a single polypeptide of 89 kDa. *J. Biol. Chem.* **267**:16365–16370.
 49. Yan, R., S. Small, C. Desplan, C. R. Dearolf, and J. E. Darnell. 1996. Identification of a Stat gene that functions in *Drosophila* development. *Cell* **84**:421–430.
 50. Wen, Z., Z. Zhong, and J. E. Darnell. 1995. Maximal activation of transcription by Stat1 and Stat3 requires both tyrosine and serine phosphorylation. *Cell* **82**:241–250.
 51. Wood, T. J. J., D. Sliva, T. Pircher, P. E. Lobie, F. Gouilleux, H. Wakao, J.-A. Gustafsson, B. Groner, G. Norstedt, and L.-A. Haldosén. 1995. Mediation of growth hormone-dependent transcriptional activation by mammary gland factor/Stat5. *J. Biol. Chem.* **16**:9448–9453.
 52. Zhang, X., J. Blenis, H.-C. Li, C. Schindler, and S. Chen-Kiang. 1995. Requirement of serine phosphorylation for formation of Stat-promoter complexes. *Science* **267**:1990–1994.