



HAL
open science

Soil properties as key predictors of global grassland production: Have we overlooked micronutrients?

Dajana Radujković, Erik Verbruggen, Eric Seabloom, Michael Bahn, Lori Biederman, Elizabeth Borer, Elizabeth Boughton, Jane Catford, Matteo Campioli, Ian Donohue, et al.

► To cite this version:

Dajana Radujković, Erik Verbruggen, Eric Seabloom, Michael Bahn, Lori Biederman, et al.. Soil properties as key predictors of global grassland production: Have we overlooked micronutrients?. Ecology Letters, 2021, 24 (12), pp.2713-2725. 10.1111/ele.13894 . hal-03410070

HAL Id: hal-03410070

<https://hal.science/hal-03410070>

Submitted on 8 Dec 2023

HAL is a multi-disciplinary open access archive for the deposit and dissemination of scientific research documents, whether they are published or not. The documents may come from teaching and research institutions in France or abroad, or from public or private research centers.

L'archive ouverte pluridisciplinaire **HAL**, est destinée au dépôt et à la diffusion de documents scientifiques de niveau recherche, publiés ou non, émanant des établissements d'enseignement et de recherche français ou étrangers, des laboratoires publics ou privés.

This document is the accepted manuscript version of the following article:
 Radujković, D., Verbruggen, E., Seabloom, E. W., Bahn, M., Biederman, L. A., Borer, E. T., ...
 Vicca, S. (2021). Soil properties as key predictors of global grassland production: have we
 overlooked micronutrients? *Ecology Letters*, 24(12), 2713–2725.
<https://doi.org/10.1111/ele.13894>

1 Soil properties as key predictors of global grassland production: have we 2 overlooked micronutrients?

3
 4 Dajana Radujković^{1*}, Erik Verbruggen¹, Eric W. Seabloom², Michael Bahn³, Lori A. Biederman⁴, Elizabeth
 5 T. Borer², Elizabeth H. Boughton⁵, Jane A. Catford⁶, Matteo Campioli¹, Ian Donohue⁷, Anne Ebeling⁸, Anu
 6 Eskelinen^{9,10,11}, Philip A. Fay¹², Amandine Hansart¹³, Johannes M.H. Knops¹⁴, Andrew S. MacDougall¹⁵,
 7 Timothy Ohlert¹⁶, Harry Olde Venterink¹⁷, Xavier Raynaud¹⁸, Anita C. Risch¹⁹, Christiane Roscher^{9,10},
 8 Martin Schütz¹⁹, Maria Lucia Silveira²⁰, Carly J. Stevens²¹, Kevin Van Sundert¹, Risto Virtanen¹¹, Glenda M.
 9 Wardle²², Peter D. Wragg², Sara Vicca¹

10

11 ¹ University of Antwerp, Department of Biology, Plants and Ecosystems, Universiteitsplein 1, 2610 Wilrijk, Belgium

12 ² University of Minnesota, Department of Ecology, Evolution and Behavior, St. Paul, MN 55108, USA

13 ³ University of Innsbruck, Department of Ecology, Sternwartestr. 15, 6020 Innsbruck, Austria

14 ⁴ Iowa State University, Department of Ecology, Evolution, and Organismal Biology, 251 Bessey Hall, Ames Iowa 50011, USA

15 ⁵ Archbold Biological Station, Buck Island Ranch Agroecology Program, 300 Buck Island Ranch, Lake Placid, FL 33852, USA

16 ⁶ Department of Geography, King's College London, 30 Aldwych, London WC2B 4BG, UK

17 ⁷ Department of Zoology, School of Natural Sciences, Trinity College Dublin, Ireland

18 ⁸ Institute of Ecology and Evolution, University Jena, Dornburger Strasse 159, 07743 Jena, Germany

19 ⁹ UFZ, Helmholtz Centre for Environmental Research, Physiological Diversity, Permoserstrasse 15, 04318 Leipzig, Germany

20 ¹⁰ German Centre for Integrative Biodiversity Research (iDiv) Halle-Leipzig-Jena, Puschstrasse 4, 04103 Leipzig, Germany

21 ¹¹ University of Oulu, Ecology & Genetics, PO Box 3000, 90014 Oulu, Finland

22 ¹² USDA-ARS Grassland Soil and Water Research Laboratory, Temple, Texas 76502, USA

23 ¹³ Ecole normale supérieure, PSL University, Département de biologie, CNRS, UMS 3194, Centre de recherche en écologie
 24 expérimentale et prédictive (CEREEP-Ecotron IleDeFrance), 11 chemin de Busseau, 77140 Saint-Pierre-lès-Nemours, France

25 ¹⁴ Department of Health and Environmental Sciences, Xián Jiaotong-Liverpool University, Suzhou, China

26 ¹⁵ Department of Integrative Biology, University of Guelph, Guelph, Ontario, Canada N1G2W1

27 ¹⁶ University of New Mexico, Department of Biology, 1 University of New Mexico, Albuquerque, New Mexico, USA

28 ¹⁷ Vrije Universiteit Brussel, Department of Biology, Pleinlaan 2, 1050 Brussels, Belgium

29 ¹⁸ Sorbonne Université, CNRS, IRD, INRAE, Université de Paris, UPEC, Institute of Ecology and Environmental Sciences-Paris, 4
 30 place Jussieu, 75005 Paris, France

31 ¹⁹ Swiss Federal Institute for Forest, Snow and Landscape Research WSL, Zuercherstrasse 111, 8903 Birmensdorf, Switzerland

32 ²⁰ University of Florida, Range Cattle Research and Education Center, 3401 Experiment Station, Ona, FL, USA 33865, USA

33 ²¹ Lancaster Environment Centre, Lancaster University, Lancaster, LA1 4YQ, UK

34 ²² University of Sydney, School of Life and Environmental Sciences, Heydon Laurence Building A08, Sydney, NSW 2006, Australia

35

36 dajana.radujkovic@uantwerpen.be, erik.verbruggen@uantwerpen.be, seabloom@umn.edu, Michael.Bahn@uibk.ac.at,

37 lbied@iastate.edu, borer@umn.edu, eboughton@archbold-station.org, jane.catford@kcl.ac.uk,

38 matteo.campioli@uantwerpen.be, DONOHUI@tcd.ie, anne.ebeling@uni-jena.de, anu.eskelinen@idiv.de, philip.fay@usda.gov,

39 amandine.hansart@ens.fr, Johannes.Knops@xjtlu.edu.cn, amacdo02@uoguelph.ca, tohlert@unm.edu,

40 harry.olde.venterink@vub.be, xavier.raynaud@upmc.fr, anita.risch@wsl.ch, christiane.roscher@ufz.de,

41 martin.schuetz@wsl.ch, mlas@ufl.edu, c.stevens@lancaster.ac.uk, kevin.vansundert@uantwerpen.be, risto.virtanen@oulu.fi,

42 glenda.wardle@sydney.edu.au, wragg004@umn.edu, sara.vicca@uantwerpen.be

43

44 **Running title:** Soil micronutrients & grassland productivity

45

46

47 **Keywords:** grasslands, biomass production, soil properties, micronutrients, climate, N deposition, zinc,
48 iron, Nutrient Network (NutNet)

49

50 **Type of article:** Letter

51

52 **Number of words in abstract:** 149

53 **Number of words in the main text:** 4946

54 **Number of references:** 78

55 **Number of figures:** 5

56

57 **Corresponding author:** Dajana Radujković, dajana.radujkovic@uantwerpen.be, +32 471 125 466

58 University of Antwerp, Universiteitsplein 1, 2610 Wilrijk, Belgium.

59

60 **Author contributions:** DR, SV and EV developed and framed research questions. MB, MC and HOV
61 contributed to conceptual development. DR analysed the data with the input from SV, ER and KVS. All
62 other co-authors contributed unpublished data. DR wrote the first draft of the manuscript, and all
63 authors contributed substantially to revisions.

64

65 **Data accessibility statement:** Data is deposited in Zenodo repository, DOI: [10.5281/zenodo.5511661](https://doi.org/10.5281/zenodo.5511661)

66

67

68

69

70

71

72

73

74

75

76

77

78

79 **Abstract**

80

81 Fertilization experiments have demonstrated that nutrient availability is a key determinant of biomass
82 production and carbon sequestration in grasslands. However, the influence of nutrients in explaining
83 spatial variation in grassland biomass production has rarely been assessed. Using a global dataset
84 comprising 72 sites on six continents, we investigated which of 16 soil factors that shape nutrient
85 availability associate most strongly with variation in grassland aboveground biomass. Climate and N
86 deposition were also considered. Based on theory-driven structural equation modelling, we found that
87 soil micronutrients (particularly Zn and Fe) were important predictors of biomass and, together with soil
88 physicochemical properties and C:N, they explained more unique variation (32%) than climate and N
89 deposition (24%). However, the association between micronutrients and biomass was absent in
90 grasslands limited by NP. These results highlight soil properties as key predictors of global grassland
91 biomass production and point to serial co-limitation by NP and micronutrients.

92

93 **Introduction**

94

95 Climatic factors, particularly precipitation, have long been recognized as major determinants of grassland
96 aboveground productivity at a global scale (Sala *et al.* 1988; Huxman *et al.* 2004). The important role of
97 soil nutrients in determining biomass production patterns has likewise long been acknowledged (Chapin
98 1980) and extensively studied in native and managed grassland ecosystems. Fertilization experiments
99 repeatedly demonstrate that grassland productivity can be significantly limited by two macronutrients in
100 particular: nitrogen and phosphorus (Craine & Jackson 2010; Harpole *et al.* 2011; Ågren *et al.* 2012; Niu

101 *et al.* 2018). In line with this, modelled anthropogenic N deposition has been shown to predict 16% of the
102 variation in global grassland biomass production (Stevens *et al.* 2015).

103

104 Co-limitation by nutrients other than N and P can also occur in many grasslands (Olde Venterink *et al.*
105 2001; Borer *et al.* 2014b; Fay *et al.* 2015; Lannes *et al.* 2016). For example, Fay *et al.* (2015) demonstrated
106 that half of the 42 investigated grasslands responded to a mixture of less-studied nutrients (potassium,
107 calcium, magnesium, sulphur) and elements found in trace amounts in plants – micronutrients (iron,
108 boron, copper, manganese, zinc). This points to a potentially significant oversight of these nutrients,
109 particularly micronutrients, given that they are rarely measured across large spatial scales. Even though
110 micronutrients are needed in much smaller quantities for plants than N and P, they are constituents of
111 prosthetic groups that catalyse redox processes, form enzyme-substrate complexes, enhance enzyme
112 reactions or play a role in protein synthesis (Fageria *et al.* 2002; Broadley *et al.* 2011). They also indirectly
113 influence plant production by regulating aspects of plant defence (e.g., tissue palatability) and
114 reproduction, e.g. by contributing to the manufacture of floral structures (Römheld & Marschner 2018).
115 While agronomists have long understood the potentially subtle but significant role of nutrients other than
116 N and P for crops (Fageria *et al.* 2002), their importance for plant production in non-agricultural grasslands
117 globally is mostly an unexplored frontier.

118

119 Thus far, it has been challenging to comprehensively examine the role of nutrient availability in global
120 grassland productivity, not only because the concentrations of many soil nutrients are not systematically
121 measured but also because, besides nutrients concentrations, nutrient availability is strongly driven by
122 soil physicochemical properties such as pH, texture, organic matter and soil cation exchange capacity
123 (Lehmann & Schroth 2005; Vicca *et al.* 2018; Van Sundert *et al.* 2019). The question thus remains: which
124 soil properties governing nutrient availability are of the most widespread importance for grassland

125 aboveground biomass production and what is their relative contribution compared to atmospheric
126 drivers?

127

128 Here, we use the comprehensive and harmonized grassland biomass and soil dataset from NutNet – a
129 globally distributed network of grasslands (Borer *et al.* 2014a) – to examine the relationship between the
130 in-situ variation in soil properties and nutrient concentrations and the variation of global grassland
131 aboveground biomass production (hereafter referred to as biomass). The data on biomass, measured in
132 a consistent manner in 72 sites around the globe (Fig. 1), were collected along with soil physicochemical
133 properties, the concentrations of 12 different soil nutrients and integrated modelled data on atmospheric
134 N deposition and climatic conditions. This dataset thus contained information about a wide set of soil
135 nutrients across globally distributed grassland sites with contrasting climatic conditions and levels of N
136 deposition.

137

138 In line with the conventional knowledge, we expected that, besides climate and N deposition, soil
139 physicochemical properties would have a predominant influence on plant biomass production due to their
140 decisive effect on overall soil fertility (Bünemann *et al.* 2018). Part of the effect of atmospheric factors
141 and soil physicochemical properties was expected to occur via their influence on the concentrations of N
142 and P, which are well-known limiting factors in grasslands (Filippelli 2008; LeBauer & Treseder 2008).
143 Less clear was whether variation in K and a range of other nutrients would have any detectable influence
144 globally, despite their acknowledged importance in plant metabolic processes. We hypothesized that the
145 influence of these nutrients might emerge in situations where N and P availability does not limit biomass
146 production (Kaspari 2021). To test these hypotheses, we used structural equation models (SEM) where
147 the variables hypothesized to be key biomass drivers were given the advantage in model construction
148 (Grace *et al.* 2010). We also tested if the relationship between important nutrients other than N and P

149 identified in the SEM and biomass persists in grasslands with low N availability and those previously shown
150 to be NP (co-) limited.

151

152 **Materials and methods**

153

154 **Experimental design and biomass sampling**

155

156 Plant aboveground biomass was sampled from 72 Nutrient Network (NutNet) grassland experimental sites
157 (www.nutnet.org) (Table S1). Sites were located on six continents and spanned a wide range of peak
158 biomass (58 – 1602 g/m²), mean annual precipitation (211 – 2813 mm) and mean annual temperature (-
159 2.7 – 27.8°C) (Fig. 1). At each site, standing crop (live biomass and recently senescent material) was
160 measured by destructively clipping aboveground vegetation at the peak of the growing season from two
161 0.1 m² (10 x 100 cm) strips for a total of 0.2 m² within 5 x 5 m permanent plots. More details on
162 experimental design for NutNet sites are described in Borer et al. (2014a). At each site, the data were
163 collected from non-fertilized plots. Total live biomass was then dried at 60°C and weighed to the nearest
164 mg. Single-time-point biomass measurements were performed between 2007 and 2017, depending on
165 the site (Table S1). Most sites contained 30 plots while 12 sites contained fewer than 10 plots (a minimum
166 of three). We calculated average standing biomass from all the plots within a site to obtain a proxy of
167 aboveground grassland biomass production [g/m²] per site. While peak standing crop is not a perfect
168 measure of biomass production (Scurlock *et al.* 2002), it has been shown that this method can be a fairly
169 good indicator for the general ranking of grassland biomass production and that it can produce similar
170 estimates compared to those obtained by more complex methods (Lauenroth *et al.* 2006). Some of the
171 sites were subject to different management practices within one year before biomass sampling. To assess
172 the potential effect of different management practices on biomass production estimates (management

173 was present in 25 out of 63 sites for which the data were available), we created a management intensity
174 index based on grazing intensity, mowing intensity and the presence of burning. Low-intensity grazing was
175 assigned with score 1, medium with 2 and high with 3. Low-intensity mowing with 1 and higher intensity
176 mowing with 2 and burning with the score 1. These scores were then summed into a management
177 intensity index (following a similar approach as in Blüthgen et al. (2012)). Moreover, to examine the effect
178 of the longer-term management history, we divided the sites into relatively pristine (unmanaged for more
179 than 20 years before the sampling; 23 sites) and more recently managed sites (39 sites).

180

181 **Soil sampling and analyses**

182

183 Soil sampling was conducted in the same 5 x 5 m plots where biomass was measured by taking three soil
184 cores (2.5 cm diameter) at a depth of 0-10 cm. The soil was subsequently pooled in one sample per plot,
185 air-dried and analysed for different nutrients (total N and total C, extractable soil P, K, Ca, Mg, Na, S, Zn,
186 Fe, B, Cu, Mn), pH, soil organic matter (SOM), and cation exchange capacity (CEC). Except for the latter
187 two at a few sites, all measurements were performed in the same years of biomass sampling. Total soil C
188 and N [mass per g of soil] were determined using dry combustion gas chromatography on an Elemental
189 Analyzer (Costech ECS 4010 CHNSO Analyzer, Valencia, CA USA). pH was determined by a pH meter in 1:1
190 soil: water v:v suspension (A&L Analytical Laboratory, Memphis, TN USA). The concentrations of
191 extractable P, K, Ca, Mg, Na, S, Zn, Fe, B, Cu and Mn [mass ppm] were analysed using the Mehlich-3
192 extraction method with Inductively Coupled Plasma Mass Spectrometry (A&L Analytical Laboratory,
193 Memphis, TN USA). Mehlich-3 analysis is considered suitable for the determination of both macro- and
194 micronutrients in a wide range of soil types (Mehlich 1984; Jones 1990). The measured concentrations
195 were in all cases above the minimum detection level for different micronutrients. While Mehlich-3 was
196 designed for acid to neutral soils, it has been shown to give reliable results in calcareous soil for most

197 micronutrients analysed in this study, except for Mn (Friedericks 1994; Iatrou *et al.* 2015). Effective cation
198 exchange capacity [meq/100g] (referred to as CEC) was estimated based on the concentrations of Ca, Mg
199 and K using the method described by Ross & Ketterings (1995). This method of determining cation
200 exchange capacity is reliable for soils with pH < 7.5 (Ross & Ketterings 1995). The percentage of soil organic
201 matter was determined using the loss on ignition method, by performing soil combustion at 400 °C. Soil
202 texture, expressed as the percentage sand, percentage silt, and percentage clay, was measured for 45
203 sites on 100 g dry soil using the Bouyoucos method (A&L Analytical Laboratory, Memphis, TN USA). The
204 values of soil parameters were averaged per site. Given that some of the methods might have limitations
205 in calcareous soils, we repeated the original analyses excluding six sites with pH higher than 7.5 and we
206 found comparable results (Fig. S2) .

207

208 **Climatic and N deposition data**

209

210 We obtained climatic data based on the site locations using global databases. Mean annual precipitation
211 (MAP) and temperature (MAT) estimates for the period between 1979 and 2013 were derived using the
212 'Climatologies at high resolution for the earth's land surface areas' database (Karger *et al.* 2017); hereafter
213 referred to as 'CHELSA'. We compared CHELSA precipitation estimates with long-term weather-station
214 measurements available for 41 sites and we used the measured values instead of CHELSA-estimates for
215 nine sites where the latter were more than 15% off. In all other cases, CHELSA-estimated and measured
216 values were very similar (Fig. S1). We further calculated the length of the growing season as the number
217 of months with a mean monthly temperature higher than 5°C. This threshold is considered to be
218 appropriate especially for mid-latitudes (Frich *et al.* 2002), where the majority of our sites are located, but
219 it was used here as a rough indicator of growing-season length for all the sites. Based on this, mean
220 precipitation and mean annual temperature during the growing season (MAPgs and MATgs, respectively)

221 were calculated and included in the analyses in addition to MAP and MAT because they might better
222 represent the conditions plants are exposed to during the period of their activity. The aridity and potential
223 evapotranspiration (PET) data were obtained using the CGIAR-CSI Global-Aridity and PET Database (Zomer
224 *et al.* 2008). Data on total inorganic nitrogen deposition [kg/ha/yr] was derived from Ackerman *et al.*
225 (2018). We used the average values over the period of years available in the database (1984-1986, 1994-
226 1996, 2004-2006, and 2014-2016) to account for long-term patterns of N fertilization via atmospheric
227 deposition.

228

229 **Statistical analyses**

230

231 ***Disentangling the predictors of aboveground biomass***

232

233 To disentangle the direct and indirect role of different (often correlated, Fig. S3) predictors, we used
234 structural equation modelling that incorporates prior knowledge in model building. With this approach,
235 the variables that are expected to have the most important role on biomass production either directly or
236 indirectly through other factors (e.g., climate through soil nutrients) were given the advantage in the
237 model construction so that their potential direct and indirect effects could be explored (Fig. 2). Variables
238 were \log_e -transformed prior to analyses in case of a skewed distribution to improve normality and
239 linearity. All analyses were performed in R (version 3.3.2) (R Core Team 2015). Structural equation models
240 were constructed using the *lavaan* package (Rosseel 2012).

241

242 We constructed SEMs representing the influence of different variables in three steps (Fig. 2c). Climate,
243 atmospheric N deposition and soil physicochemical properties determining soil fertility (SOM, CEC, pH)
244 were expected to be the main overarching drivers of global grassland biomass production (Sala *et al.* 1988;

245 Huxman *et al.* 2004; Stevens *et al.* 2015; Bünemann *et al.* 2018) and their influence was therefore tested
246 first (Fig 2c). In addition, we hypothesized that the availability of the most limiting macronutrients (NP)
247 and/or other nutrients explain additional variation due to their important role in (co)-limiting grassland
248 productivity (Olde Venterink *et al.* 2001; Elser *et al.* 2007; Harpole *et al.* 2011; Fay *et al.* 2015; Lannes *et*
249 *al.* 2020). Besides direct effects, we tested all possible indirect effects of climate on aboveground biomass
250 through soil physicochemical properties (Zhao *et al.* 2019) and soil nutrients (Havlin 2004; Bünemann *et*
251 *al.* 2018) (Fig. 2b). Precipitation was also expected to have an additional indirect influence on
252 aboveground biomass through atmospheric N deposition as precipitation determines wet N deposition
253 rates (Prado-Fiedler 1990; Kryza *et al.* 2011; Wałaszek *et al.* 2013). Moreover, given that atmospheric N
254 deposition is typically high in regions with strong anthropogenic influences, we expected that
255 precipitation could be related to increased anthropogenic deposition of other nutrients and thereby to
256 soil nutrient concentrations (Deboudt *et al.* 2004; Vet *et al.* 2014).

257

258 Prior to SEM construction, automated model selection using *glmulti* (Calcagno & Mazancourt 2010) based
259 on AICc was performed to determine the combination of atmospheric factors (MAPgs, MATgs, MAP, MAT,
260 aridity, PET and N deposition) that best explained the variation in biomass. These were then used to build
261 the 'core' SEM together with soil physicochemical properties SOM, CEC and pH (Fig. 2c, Table S2). The
262 effect of soil texture was also tested on the subset of sites for which the data were available. Each of the
263 soil physicochemical properties was added separately to the model containing atmospheric factors. All
264 those that significantly contributed ($P < 0.05$) to explaining additional variation were retained and grouped
265 into one composite variable (following a similar approach as in Grace *et al.* (2016)). This was done by
266 summing the product of each soil property with their coefficient in the full SEM model including
267 atmospheric factors and all retained soil physicochemical properties. The model was then reconstructed
268 substituting the individual soil physicochemical properties with the composite variable. In the following

269 steps, N, C/N and P were separately added to the previous model (Fig. 2b) and those that had a significant
270 contribution were retained and grouped into one composite variable representing this group of
271 macronutrients. The same procedure was applied in the next step for other nutrients (K, Ca, Mg, S, Na,
272 Zn, Fe, Mn, Cu, B).

273

274 The fit was assessed using standard indices, where model chi-square (χ^2) $P > 0.05$, comparative fit index
275 (CFI) > 0.95 , Tucker-Lewis index (TLI) > 0.95 , root mean squared error of approximation (RMSEA) < 0.08 ,
276 and standardized root mean square residual (SRMR) < 0.08 were considered as indicators of a good fit
277 (Hooper *et al.* 2008). In each step, the models with a good fit, significant (direct or indirect) paths and the
278 highest R^2 was selected and reported.

279

280 We further constructed a multiple regression model using the variables with a significant direct path (i.e.,
281 black line in Fig. 2b) on biomass in the final SEM and partitioned the variance explained by atmospheric
282 and soil factors. The model performance was evaluated via repeated (100 times) k-fold ($k = 10$) cross-
283 validation using the *caret* package.

284

285 ***Examining the influence of N availability levels and N/NP (co)limitation on the relationship between***
286 ***other selected nutrients and biomass***

287

288 We hypothesized that the influence of soil nutrients other than NP selected as important predictors of
289 biomass in the prior step would depend on grassland N availability. To test this hypothesis, we first
290 assigned each grassland site to two groups according to their C:N ratios (low and high) and N deposition
291 levels (low and high) and combined them to obtain a variable with four categories (low C:N - low N
292 deposition, low C:N - high N deposition, high C:N - low N deposition, high C:N - high N deposition). The

293 threshold between 'low' and 'high' levels of N deposition and C:N was based on 50% quantiles (cut-offs
294 of 3.64 kg/h/y and 13.2, respectively). The median value for C:N in our study was comparable to the
295 average C:N value found in worldwide-distributed grasslands (Cleveland & Liptzin 2007) supporting its use
296 to contrast relatively low and high C:N. Mean values of N deposition were 1.73 ± 0.78 / 8.38 ± 4.23 , and
297 of C:N = 11.36 ± 1.54 / 16.68 ± 4.08 in the low and the high group, respectively. The group with high C:N
298 and low N deposition is here considered as the 'low N availability level'. This assumption is based on the
299 general finding that C:N is a relatively robust indicator of spatial variation in N availability, where
300 increasing C:N can indicate decreasing N availability (Andrianarisoa *et al.* 2009; Wang *et al.* 2014; Alberti
301 *et al.* 2015; Vicca *et al.* 2018), while atmospheric N deposition can substantially increase N availability but
302 it can take very long for this effect to be translated in a decrease of soil C:N (Vicca *et al.* 2018). We then
303 performed linear regression analyses between selected nutrients and biomass for each group. To test the
304 sensitivity of the chosen threshold and examine the potential influence of the values close to the median,
305 we performed an additional analysis using the threshold of < 33% quantiles for the 'low' group (the
306 threshold value for N deposition = 1.97 kg/ha/y and for C:N = 12.08; mean N deposition in the group =
307 1.27 ± 0.39 , mean C:N = 10.7 ± 1.48) and > 66% quantiles in the 'high' group (the threshold value for N
308 deposition = 5.34 kg/ha/y and for C:N = 14.4; mean N deposition in the group = 10.01 ± 4.0 , mean C:N =
309 18.01 ± 4.3). These analyses provided very similar results (Table S6).

310

311 Given that soil C:N and N deposition may not be accurate indicators of soil N availability for all sites (Risch
312 *et al.* 2019), the effect of N limitation on the relationship between selected soil nutrients and biomass was
313 more explicitly examined using the results of the experimental study by Fay *et al.* (2015). To this end, we
314 explored this relationship for NutNet sites that had previously been demonstrated to be N limited, co-
315 limited by N and P, or without limitation by N alone or combined with P. The normality of residuals of the
316 linear regression analyses was tested using the Shapiro-Wilk test ($P > 0.05$). Fay *et al.* (2015) assessed N

317 (co-)limitation in 38 of the 72 sites included in our dataset. The N(co-)limitation status of the other 34
318 sites was not known and it thus was not possible to confirm that the groups that we designated as having
319 low N availability generally contained N (co-)limited sites.

320

321 **Results**

322

323 *Disentangling the predictors of aboveground biomass*

324

325 Structural equation modelling revealed that, in the most parsimonious core model, a composite variable
326 describing soil physicochemical properties (based on SOM and CEC, Table S3) had the strongest influence
327 (factor loading) on biomass, followed by mean annual precipitation during the growing season (MAPgs)
328 which additionally had an indirect effect through N deposition (Fig. 3a). In the second step, N, P and C:N
329 were added but only C:N had a significant effect and was retained in the model (Fig. 3b). In the last step,
330 other nutrients were sequentially added to the previous model out of which two micronutrients (Zn and
331 Fe) were significantly associated with variation in biomass. These were retained and combined into a
332 micronutrient composite variable (Table S3) which was significantly influenced by N deposition and soil
333 physicochemical properties. The final model explained 61% of the variation in biomass (Fig. 3c).

334

335 The specific effect of soil texture (%sand, %silt, %clay and sand-to-silt ratio) on biomass was tested in
336 separate analyses conducted on the subset of sites for which the data were available ($n = 45$). While silt
337 had a significant positive and sand to silt ratio had a significant negative association with biomass ($R^2 =$
338 18% , $R^2 = 16\%$, $P < 0.01$), this effect was already contained in other correlated core variables (mainly CEC)
339 and the path from silt or silt:sand to biomass in the SEM model was not significant. Hence, the effect of
340 soil texture on biomass was captured by the composite variable representing soil physicochemical

341 properties. It was confirmed that the final SEM for the reduced dataset was similar to the one for the full
342 dataset, such that removing the sites lacking texture data did not affect overall conclusions.

343

344 A multiple regression model composed of the variables with a significant direct effect on biomass in the
345 final SEM (MAPgs, N deposition, soil physicochemical composite, C:N and micronutrient composite; the
346 individual relationship between these variables and biomass are shown in Fig. S3) explained 58% of the
347 variation in biomass. Repeated K-fold cross-validation demonstrated that this model predicted 56% of the
348 variation in the validation dataset. Variance partitioning revealed that soil factors together explained a
349 higher proportion of unique variation in biomass than atmospheric factors, i.e., precipitation and
350 atmospheric N deposition (32% vs 24%, respectively).

351

352 We additionally tested the impact of land-use intensity and management history on biomass production
353 across sites using linear regression and ANCOVA analyses and found no significant effects with or without
354 accounting for the effect of the most important atmospheric predictors (Table S5).

355

356 ***The influence of N(P) limitation on the relationship between micronutrients and biomass***

357

358 To investigate the potential influence of soil N availability on the micronutrient-biomass relationship, we
359 created different 'N availability' levels by splitting the dataset into four classes, where the group with high
360 C:N ratio and low N deposition was considered as the low 'N availability' group. Linear regression analyses
361 for each of these four groups showed that the relationship between the micronutrient composite and
362 biomass was significantly positive in all but the 'low N availability' group (Fig. 4, Table S6).

363

364 To corroborate these findings, we further explored the micronutrient-biomass relationship for the subset
365 of sites previously demonstrated to be N limited or NP co-limited and those that had no N limitation / NP
366 co-limitation in the fertilization study by Fay et al. (2015). In line with the previous results, the relationship
367 between micronutrient composite and biomass was not detected in N(P)(co-)limited grasslands (Fig. 5a,c)
368 as opposed to grasslands with no signs of N(P) (co-)limitation (Fig. 5b,d) (Table S7).

369

370 **Discussion**

371

372 Our results clearly demonstrate the importance of soil factors that govern nutrient availability, i.e., soil
373 physicochemical properties, C:N, and concentrations of soil micronutrients, as predictors of global
374 grassland production. Together, they explained 32% of the unique (non-shared) variation in the most
375 parsimonious model predicting global grassland biomass, more than precipitation and atmospheric N
376 deposition combined. It is noteworthy, however, that the atmospheric factors in this dataset were
377 estimated rather than measured at each site which is why their perceived effect on biomass might be less
378 accurate than for soil properties. Nonetheless, considering the large gradient in climatic conditions, the
379 lower accuracy for atmospheric estimates does not preclude the conclusion that soil properties are
380 important predictors of global biomass production. Moreover, some of the sites in this study were
381 exposed to various types of (mainly low-intensity) management in years prior to biomass sampling. We
382 found no evidence that management had a consistent influence on biomass across worldwide distributed
383 sites, where the large differences in soil properties and climate likely play a predominant role. Therefore,
384 while land use can have long term impacts on plant biomass and soil chemistry (Isbell *et al.* 2019; Borer
385 *et al.* 2020), management history is unlikely to alter the conclusions of our study.

386

387 Soil organic matter content, soil texture and cation exchange capacity are key determinants of soil fertility
388 and overall nutrient availability (Havlin 2004; Bünemann *et al.* 2018). Organic matter is a source of
389 nutrients (Schroeder & Gething 1984; Roy *et al.* 2006), which also determines the CEC of soil, indicating
390 its capacity to store and exchange important nutrients. In this study, the index of soil physicochemical
391 properties was strongly correlated with concentrations of different soil nutrients. Overall, this index was
392 a better predictor of grassland biomass than the concentrations of most nutrients. Nonetheless, C:N as
393 one of the indicators of soil N availability (Vicca *et al.* 2018), explained additional variation in biomass
394 together with the index of micronutrient availability based on Zn and Fe. SOM has been shown to play a
395 critical role in driving the transformation and enhancing the accessibility of micronutrient
396 cations (Obrador *et al.* 2003; Cakmak 2008; Chen *et al.* 2017) and our structural equation modelling
397 revealed that the effect of soil physicochemical properties on biomass might partly be mediated by soil -
398 micronutrients.

399

400 The potentially important contributing role of micronutrients for grassland productivity has been
401 highlighted in fertilization experiments (Fay *et al.* 2015; Lannes *et al.* 2016), but few studies in non-
402 agricultural grasslands focused on micronutrients additions specifically (however, see Lannes *et al.* (2020)
403 for the role of B as limiting factor in Cerrado grasslands). Therefore, the role of micronutrient deficiency
404 in the productivity of non-agricultural grasslands globally has not been explicitly considered. Even though
405 micronutrients are only needed in relatively small concentrations and in high concentrations they can be
406 toxic to plants, micronutrient deficiency has been well documented in arable systems (Sillanpää 1982,
407 1990) where it was found to influence plant growth and limit plant yield in many regions of the world
408 (Rashid & Ryan 2004; Alloway 2008; Shukla *et al.* 2014). For instance, Sillanpää (1990) showed that Zn
409 deficiency occurred in almost 50% out of 190 investigated agricultural soils.

410

411 Arable fields are typically subjected to long-term fertilization by macronutrients which can, in turn, induce
412 or exacerbate micronutrient limitations. Similarly, in our study, the relationship between micronutrient
413 availability and biomass was present only in grasslands with no signs of N (and P) co-limitations suggesting
414 that when N and P are ample in grassland soils (either naturally or e.g., due to atmospheric fertilization),
415 there might be an increased demand for micronutrients which become limiting for plant growth. These
416 results provide support for serial co-limitation, in which the response to additional micronutrient
417 resources occurs only after N and P have been added (Harpole *et al.* 2011; Kaspari 2021). This imbalanced
418 need for macronutrients before growth-limitation by micronutrients builds from earlier work
419 demonstrating substantial variation among sites in the combinations of elements limiting growth (Fay *et*
420 *al.* 2015). The positive effect of micronutrient fertilization on the yield of agricultural plants grown in soils
421 with low N(P) and micronutrient availability has been shown to be contingent on N(P) fertilization in
422 several studies (Loneragan & Webb 1993; Cakmak *et al.* 2010; Sahrawat *et al.* 2010). Moreover, N is
423 important for uptake and translocation of certain micronutrients, particularly Zn (Cakmak *et al.* 2010; Shi
424 *et al.* 2010; Erenoglu *et al.* 2011; Gupta *et al.* 2016) which could be another explanation for the lack of the
425 relationship between micronutrients and biomass under low N availability found in this study.

426

427 Micronutrient deficiencies are not per se a consequence of low total concentrations of these nutrients in
428 soil but rather as a result of soil factors that reduce their availability to plants (Sillanpää 1982). Our results
429 show that the grasslands located in the regions with higher temperatures and potential
430 evapotranspiration, with predominantly sandy soils poor in organic matter might be prone to Zn and Fe
431 deficiencies while other micronutrients might be deficient in soils with low cation exchange capacity (Fig.
432 S5). It has previously been shown that drylands and alkaline (calcareous) soils are particularly prone to
433 micronutrient deficiencies (Chen & Barak 1982; Fageria *et al.* 2002). Our dataset included only few
434 grasslands in arid regions with alkaline soils, but it is possible that the effect of micronutrients on biomass

435 production in such grasslands would be even more pronounced. The expansion of aridity in grasslands
436 might thus further exacerbate micronutrient deficiencies in future (Moreno-Jiménez *et al.* 2019). On the
437 other hand, combined macronutrient and micronutrient deposition (which are often tightly related to
438 industrial activities (Pan & Wang 2015) might alleviate them.

439

440 This study emphasizes the importance of soil physicochemical properties and nutrients including
441 micronutrients, for predicting grassland biomass production globally. Although observational studies
442 cannot fully disentangle causal relationships, our results highlight the potential undervalued role of
443 micronutrients in global plant productivity while motivating future experiments. Such manipulation
444 experiments should focus on micronutrient (especially Zn) additions, alone and in combination with NP,
445 particularly in the grasslands that are likely to be prone to micronutrient deficiencies (high sand content,
446 low organic matter content, calcareous soils) to further unravel the role that nutrients play in determining
447 grassland productivity. It would also be beneficial to measure soil properties and nutrients (Vicca *et al.*
448 2018), including micronutrients (both in plants and soil) in studies investigating grassland productivity.
449 This would allow to determine the extent of deficiencies of these nutrients and their link with grassland
450 productivity. Given the critical role of nutrient availability in mediating grassland responses to
451 environmental changes (Van Sundert *et al.* 2021), information on soil properties and nutrients is essential
452 to fully unravel the impact of global changes on grasslands and other ecosystems.

453

454 **Acknowledgements**

455

456 This work was generated using data from the Nutrient Network (<http://www.nutnet.org>) experiment,
457 funded at the site-scale by individual researchers. Coordination and data management have been
458 supported by funding to E. Borer and E. Seabloom from the National Science Foundation Research

459 Coordination Network (NSF-DEB-1042132) and Long Term Ecological Research (NSF-DEB-1234162
460 and NSF-DEB-1831944 to Cedar Creek LTER) programs, and the Institute on the Environment (DG-0001-
461 13). We also thank the Minnesota Supercomputer Institute for hosting project data and the Institute on
462 the Environment for hosting Network meetings. This research was supported by the Research
463 Foundation—Flanders (FWO), the European Research Council grant ERC-SyG-610028 IMBALANCE-P and
464 Methusalem funding of the Research Council UA. We thank E. Fransen for statistical advice as well as J.
465 Lembrechts and M. Portillo-Estrada for their help with figure editing.

466

467 **References**

468

- 469 Ackerman, D., Chen, X. & Millet, D. (2018). *Global nitrogen deposition (2°×2.5° grid resolution) simulated*
470 *with GEOS-Chem for 1984-1986, 1994-1996, 2004-2006, and 2014-2016. Retrieved from Data*
471 *Repos. Univ. Minnesota. Available at: <https://conservancy.umn.edu/handle/11299/197613>.*
- 472 Ågren, G.I., Wetterstedt, J.Å.M. & Billberger, M.F.K. (2012). Nutrient limitation on terrestrial plant
473 growth - modeling the interaction between nitrogen and phosphorus. *New Phytol.*, 194, 953–960.
- 474 Alberti, G., Vicca, S., Inglima, I., Beilelli-Marchesini, L., Genesio, L., Miglietta, F., *et al.* (2015). Soil C:N
475 stoichiometry controls carbon sink partitioning between above-ground tree biomass and soil
476 organic matter in high fertility forests. *iForest - Biogeosciences For.*, 8, 195–206.
- 477 Alloway, B.J. (2008). Micronutrients and Crop Production: An Introduction. In: *Micronutrient Deficiencies*
478 *in Global Crop Production*. Springer Netherlands, Dordrecht, pp. 1–39.
- 479 Andrianarisoa, K.S., Zeller, B., Dupouey, J.L. & Dambrine, E. (2009). Comparing indicators of N status of
480 50 beech stands (*Fagus sylvatica* L.) in northeastern France. *For. Ecol. Manage.*, 257, 2241–2253.
- 481 Blüthgen, N., Dormann, C.F., Prati, D., Klaus, V.H., Kleinebecker, T., Hölzel, N., *et al.* (2012). A
482 quantitative index of land-use intensity in grasslands: Integrating mowing, grazing and fertilization.

- 483 *Basic Appl. Ecol.*, 13, 207–220.
- 484 Borer, E.T., Harpole, W.S., Adler, P.B., Arnillas, C.A., Bugalho, M.N., Cadotte, M.W., *et al.* (2020).
485 Nutrients cause grassland biomass to outpace herbivory. *Nat. Commun.*, 11.
- 486 Borer, E.T., Harpole, W.S., Adler, P.B., Lind, E.M., Orrock, J.L., Seabloom, E.W., *et al.* (2014a). Finding
487 generality in ecology: A model for globally distributed experiments. *Methods Ecol. Evol.*, 5, 65–73.
- 488 Borer, E.T., Seabloom, E.W., Mitchell, C.E. & Cronin, J.P. (2014b). Multiple nutrients and herbivores
489 interact to govern diversity, productivity, composition, and infection in a successional grassland.
490 *Oikos*, 123, 214–224.
- 491 Broadley, M., Brown, P., Cakmak, I., Rengel, Z. & Zhao, F. (2011). Function of Nutrients: Micronutrients.
492 In: *Marschner's Mineral Nutrition of Higher Plants: Third Edition*. Elsevier Inc., pp. 191–248.
- 493 Bünemann, E.K., Bongiorno, G., Bai, Z., Creamer, R.E., De Deyn, G., de Goede, R., *et al.* (2018). Soil
494 quality – A critical review. *Soil Biol. Biochem.*, 120, 105–125.
- 495 Cakmak, I. (2008). Enrichment of cereal grains with zinc: Agronomic or genetic biofortification? *Plant*
496 *Soil*, 302, 1–17.
- 497 Cakmak, I., Kalayci, M., Kaya, Y., Torun, A.A., Aydin, N., Wang, Y., *et al.* (2010). Biofortification and
498 localization of zinc in wheat grain. *J. Agric. Food Chem.*, 58, 9092–9102.
- 499 Calcagno, V. & Mazancourt, C. de. (2010). glmulti : An R package for easy automated model selection
500 with (generalized) linear models. *J. Stat. Softw.*, 34, 1–29.
- 501 Chapin, F.S. (1980). The mineral nutrition of wild plants. *Annu. Rev. Ecol. Syst.*, 11, 233–260.
- 502 Chen, Y. & Barak, P. (1982). Iron nutrition of plants in calcareous soils. *Adv. Agron.*, 35, 217–240.
- 503 Chen, Y., Cui, J., Tian, X., Zhao, A., Li, M., Wang, S., *et al.* (2017). Effect of straw amendment on soil Zn
504 availability and ageing of exogenous water-soluble Zn applied to calcareous soil. *PLoS One*, 12,
505 e0169776.
- 506 Cleveland, C.C. & Liptzin, D. (2007). C:N:P stoichiometry in soil: Is there a “Redfield ratio” for the

- 507 microbial biomass. *Biogeochemistry*, 85, 235–252.
- 508 Craine, J.M. & Jackson, R.D. (2010). Plant nitrogen and phosphorus limitation in 98 North American
509 grassland soils. *Plant Soil*, 334, 73–84.
- 510 Deboudt, K., Flament, P. & Bertho, M.L. (2004). Cd, Cu, Pb and Zn concentrations in atmospheric wet
511 deposition at a coastal station in Western Europe. *Water, Air, Soil Pollut.*, 151, 335–359.
- 512 Elser, J.J., Bracken, M.E.S., Cleland, E.E., Gruner, D.S., Harpole, W.S., Hillebrand, H., *et al.* (2007). Global
513 analysis of nitrogen and phosphorus limitation of primary producers in freshwater, marine and
514 terrestrial ecosystems. *Ecol. Lett.*, 10, 1135–1142.
- 515 Erenoglu, E.B., Kutman, U.B., Ceylan, Y., Yildiz, B. & Cakmak, I. (2011). Improved nitrogen nutrition
516 enhances root uptake, root-to-shoot translocation and remobilization of zinc (65Zn) in wheat. *New*
517 *Phytol.*, 189, 438–448.
- 518 Fageria, N.K., Baligar, V.C. & Clark, R.B. (2002). Micronutrients in Crop Production. In: *Advances in*
519 *agronomy*. Academic Press, pp. 185–268.
- 520 Fay, P.A., Prober, S.M., Harpole, S.W., Knops, J.M., Bakker, J.D., Borer, E.T., *et al.* (2015). Grassland
521 productivity limited by multiple nutrients. *Nat. Plants*, 1, 1–5.
- 522 Filippelli, G.M. (2008). The global phosphorus cycle: Past, present, and future. *Elements*, 4, 89–95.
- 523 Frich, P., Alexander, L., Della-Marta, P., Gleason, B., Haylock, M., Klein Tank, A., *et al.* (2002). Observed
524 coherent changes in climatic extremes during the second half of the twentieth century. *Clim. Res.*,
525 19, 193–212.
- 526 Friedericks, J.B. (1994). Soil micronutrient extraction by mehlich-3 compared to caci2-dtpa. *Commun.*
527 *Soil Sci. Plant Anal.*, 25, 1583–1593.
- 528 Grace, J.B., Anderson, T.M., Olf, H. & Scheiner, S.M. (2010). On the specification of structural equation
529 models for ecological systems. *Ecol. Monogr.*, 80, 67–87.
- 530 Grace, J.B., Anderson, T.M., Seabloom, E.W., Borer, E.T., Adler, P.B., Harpole, W.S., *et al.* (2016).

- 531 Integrative modelling reveals mechanisms linking productivity and plant species richness. *Nature*,
532 529, 390–393.
- 533 Gupta, N., Ram, H. & Kumar, B. (2016). Mechanism of Zinc absorption in plants: uptake, transport,
534 translocation and accumulation. *Rev. Environ. Sci. Biotechnol.*, 15, 89–109.
- 535 Harpole, W., Goldstein, L. & Aicher, R. (2007). Resource Limitation. In: *Ecology and Management of*
536 *California Grassland*. Berkeley, pp. 119–127.
- 537 Harpole, W.S., Ngai, J.T., Cleland, E.E., Seabloom, E.W., Borer, E.T., Bracken, M.E.S., *et al.* (2011).
538 Nutrient co-limitation of primary producer communities. *Ecol. Lett.*, 14, 852–862.
- 539 Havlin, J.L. (2004). Fertility. In: *Encyclopedia of Soils in the Environment*. Elsevier Inc., pp. 10–19.
- 540 Hooper, D., Coughlan, J. & Mullen, M. (2008). Structural equation modelling: Guidelines for determining
541 model fit. *Electron. J. Bus. Res. Methods*, 6, 53–60.
- 542 Huxman, T.E., Smith, M.D., Fay, P.A., Knapp, A.K., Shaw, M.R., Loik, M.E., *et al.* (2004). Convergence
543 across biomes to a common rain-use efficiency. *Nature*, 429, 651–654.
- 544 Iatrou, M., Papadopoulos, A., Papadopoulos, F., Dichala, O., Psoma, P. & Bountla, A. (2015).
545 Determination of soil-available micronutrients using the DTPA and Mehlich 3 methods for Greek
546 soils having variable amounts of calcium carbonate. *Commun. Soil Sci. Plant Anal.*, 46, 1905–1912.
- 547 Isbell, F., Tilman, D., Reich, P.B. & Clark, A.T. (2019). Deficits of biodiversity and productivity linger a
548 century after agricultural abandonment. *Nat. Ecol. Evol.*, 3, 1533–1538.
- 549 Jones, J.B. (1990). Universal soil extractants: their composition and use. *Commun. Soil Sci. Plant Anal.*,
550 21, 1091–1101.
- 551 Karger, D.N., Conrad, O., Böhner, J., Kawohl, T., Kreft, H., Soria-Auza, R.W., *et al.* (2017). Climatologies at
552 high resolution for the earth's land surface areas. *Sci. Data*, 4, 1–20.
- 553 Kaspari, M. (2021). The invisible hand of the periodic table: how micronutrients shape ecology. *Annu.*
554 *Rev. Ecol. Evol. Syst.*, 52, 199–219.

- 555 Kryza, M., Dore, A.J., Błaś, M. & Sobik, M. (2011). Modelling deposition and air concentration of reduced
556 nitrogen in Poland and sensitivity to variability in annual meteorology. *J. Environ. Manage.*, 92,
557 1225–1236.
- 558 Lannes, L.S., Bustamante, M.M.C., Edwards, P.J. & Olde Venterink, H. (2016). Native and alien
559 herbaceous plants in the Brazilian Cerrado are (co-)limited by different nutrients. *Plant Soil*, 400,
560 231–243.
- 561 Lannes, L.S., Olde Venterink, H., Leite, M.R., Silva, J.N. & Oberhofer, M. (2020). Boron application
562 increases growth of Brazilian Cerrado grasses. *Ecol. Evol.*, 10, 6364–6372.
- 563 Lauenroth, W.K., Wade, A.A., Williamson, M.A., Ross, B.E., Kumar, S. & Cariveau, D.P. (2006).
564 Uncertainty in calculations of net primary production for grasslands. *Ecosystems*, 9, 843–851.
- 565 LeBauer, D. & Treseder, K. (2008). Nitrogen limitation of net primary productivity in terrestrial
566 ecosystems is globally distributed. *Ecology*, 89, 371–379.
- 567 Lehmann, J. & Schroth, G. (2005). Nutrient leaching. In: *Trees, crops, and soil fertility: concepts and*
568 *research methods*. Center for Agriculture and Biosciences International (CABI) Publishing,
569 Wallingford, Oxon, pp. 151–166.
- 570 Loneragan, J.F. & Webb, M.J. (1993). Interactions between zinc and other nutrients affecting the growth
571 of plants. In: *Zinc in soils and plants*. Springer Netherlands, pp. 119–134.
- 572 Mehlich, A. (1984). Mehlich 3 soil test extractant: A modification of Mehlich 2 extractant. *Commun. Soil*
573 *Sci. Plant Anal.*, 15, 1409–1416.
- 574 Moreno-Jiménez, E., Plaza, C., Saiz, H., Manzano, R., Flagmeier, M. & Maestre, F.T. (2019). Aridity and
575 reduced soil micronutrient availability in global drylands. *Nat. Sustain.*, 2, 371–377.
- 576 Niu, D., Yuan, X., Cease, A.J., Wen, H., Zhang, C., Fu, H., *et al.* (2018). The impact of nitrogen enrichment
577 on grassland ecosystem stability depends on nitrogen addition level. *Sci. Total Environ.*, 618, 1529–
578 1538.

- 579 Obrador, A., Novillo, J. & Alvarez, J.M. (2003). Mobility and availability to plants of two zinc sources
580 applied to a calcareous soil. *Soil Sci. Soc. Am. J.*, 67, 564–572.
- 581 Olde Venterink, H., van der Vliet, R.E. & Wassen, M.J. (2001). Nutrient limitation along a productivity
582 gradient in wet meadows. *Plant Soil*, 234, 171–179.
- 583 Pan, Y.P. & Wang, Y.S. (2015). Atmospheric wet and dry deposition of trace elements at 10 sites in
584 Northern China. *Atmos. Chem. Phys.*, 15, 951–972.
- 585 Prado-Fiedler, R. (1990). On the relationship between precipitation amount and wet deposition of
586 nitrate and ammonium. *Atmos. Environ. Part A. Gen. Top.*, 24, 3061–3065.
- 587 R Core Team. (2015). R: A language and environment for statistical computing. R Foundation for
588 Statistical Computing.
- 589 Rashid, A. & Ryan, J. (2004). Micronutrient constraints to crop production in soils with mediterranean-
590 type characteristics: A review. *J. Plant Nutr.*, 27, 959–975.
- 591 Risch, A.C., Zimmermann, S., Ochoa-Hueso, R., Schütz, M., Frey, B., Firn, J.L., *et al.* (2019). Soil net
592 nitrogen mineralisation across global grasslands. *Nat. Commun.*, 10, 1–10.
- 593 Römheld, V. & Marschner, H. (2018). Function of Micronutrients in Plants. In: *Micronutrients in*
594 *agriculture 4*. John Wiley & Sons, Ltd, pp. 297–328.
- 595 Ross, D.S. & Ketterings, Q. (1995). Recommended methods for determining soil cation exchange
596 capacity. *Recomm. soil Test. Proced. Northeast. United States*, 2, 62–70.
- 597 Rosseel, Y. (2012). lavaan: An R package for structural equation modeling. *J. Stat. Softw.*, 48, 1–36.
- 598 Roy, R., Finck, A., Blair, G. & Tandon, H. (2006). *Plant nutrition for food security: A guide for integrated*
599 *nutrient management*. (FAO Fertilizer and Plant Nutrition Bulletin) vol 16 (Rome: Food and
600 Agriculture Organization of the United Nations).
- 601 Sahrawat, K.L., Wani, S.P., Pardhasaradhi, G. & Murthy, K.V.S. (2010). Diagnosis of secondary and
602 micronutrient deficiencies and their management in rainfed agroecosystems: Case study from

- 603 Indian semi-arid tropics. *Commun. Soil Sci. Plant Anal.*, 41, 346–360.
- 604 Sala, O.E., Parton, W.J., Joyce, L.A. & Lauenroth, W.K. (1988). Primary production of the central
605 grassland region of the United States. *Ecology*, 69, 40–45.
- 606 Schroeder, D. & Gething, P. (1984). *Soils - facts and concepts*. Bern, Switzerland: International Potash
607 Institute.
- 608 Scurlock, J.M.O., Johnson, K. & Olson, R.J. (2002). Estimating net primary productivity from grassland
609 biomass dynamics measurements. *Glob. Chang. Biol.*, 8, 736–753.
- 610 Shi, R., Zhang, Y., Chen, X., Sun, Q., Zhang, F., Römheld, V., *et al.* (2010). Influence of long-term nitrogen
611 fertilization on micronutrient density in grain of winter wheat (*Triticum aestivum* L.). *J. Cereal Sci.*,
612 51, 165–170.
- 613 Shukla, A.K., Tiwari, P.K. & Prakash, C. (2014). Micronutrients deficiencies vis-a-vis food and nutritional
614 security of India. *Indian J. Fertil.*, 10, 94–112.
- 615 Sillanpää, M. (1982). Micronutrients and the nutrient status of soil: a global study. *FAO soils Bull.*, 48.
- 616 Sillanpää, M. (1990). Micronutrient assessment at the country level: an international study. *Micronutr.*
617 *Assess. Ctry. Lev. an Int. study*.
- 618 Stevens, C.J., Lind, E.M., Hautier, Y., Harpole, W.S., Borer, E.T., Hobbie, S., *et al.* (2015). Anthropogenic
619 nitrogen deposition predicts local grassland primary production worldwide. *Ecology*, 96, 1459–
620 1465.
- 621 Van Sundert, K., Arfin Khan, M.A.S., Bharath, S., Buckley, Y.M., Caldeira, M.C., Donohue, I., *et al.* (2021).
622 Fertilized graminoids intensify negative drought effects on grassland productivity. *Glob. Chang.*
623 *Biol.*, gcb.15583.
- 624 Van Sundert, K., Radujković, D., Cools, N., De Vos, B., Etzold, S., Fernández-Martínez, M., *et al.* (2019).
625 Towards comparable assessment of the soil nutrient status across scales—Review and
626 development of nutrient metrics. *Glob. Chang. Biol.*, 26, 392–409.

- 627 Vet, R., Artz, R.S., Carou, S., Shaw, M., Ro, C.U., Aas, W., *et al.* (2014). A global assessment of
628 precipitation chemistry and deposition of sulfur, nitrogen, sea salt, base cations, organic acids,
629 acidity and pH, and phosphorus. *Atmos. Environ.*, 93, 3–100.
- 630 Vicca, S., Stocker, B.D., Reed, S., Wieder, W.R., Bahn, M., Fay, P.A., *et al.* (2018). Using research networks
631 to create the comprehensive datasets needed to assess nutrient availability as a key determinant
632 of terrestrial carbon cycling. *Environ. Res. Lett.*, 13, 125006.
- 633 Wałaszek, K., Kryza, M. & Dore, A.J. (2013). The impact of precipitation on wet deposition of sulphur and
634 nitrogen compounds. *Ecol. Chem. Eng. S*, 20, 733–745.
- 635 Wang, C., Wang, X., Liu, D., Wu, H., Lü, X., Fang, Y., *et al.* (2014). Aridity threshold in controlling
636 ecosystem nitrogen cycling in arid and semi-Arid grasslands. *Nat. Commun.*, 5, 1–8.
- 637 Zhao, X., Yang, Y., Shen, H., Geng, X. & Fang, J. (2019). Global soil–climate–biome diagram: linking
638 surface soil properties to climate and biota. *Biogeosciences*, 16, 2857–2871.
- 639 Zomer, R.J., Trabucco, A., Bossio, D.A. & Verchot, L. V. (2008). Climate change mitigation: A spatial
640 analysis of global land suitability for clean development mechanism afforestation and
641 reforestation. *Agric. Ecosyst. Environ.*, 126, 67–80.

642

643 **Figure captions**

644

645 **Figure 1** The distribution of 72 NutNet grassland sites along the precipitation gradient. White points indicate the
646 location of different sites and different sizes of pink circles correspond to the amount of aboveground biomass per
647 site.

648

649 **Figure 2** The scheme depicting the methodological approach used in the study to examine the predictors of
650 aboveground biomass production **a)** Three groups of variables and hypothesized relationships between them used
651 in the construction of SEM. **b)** The theoretical direct (black full lines) and indirect paths (dotted grey lines) from

652 different variables to biomass that were tested in SEMs. The numbers indicate the order in which the influence of
653 different factors was examined (1 refers to glmulti pre-selection of atmospheric variables). c) Step-by-step
654 construction of SEMs. The core model explaining variation in biomass was constructed using atmospheric factors
655 and soil physicochemical properties (pcp). Those pcps that had significant contributions in the model were grouped
656 into one composite pcp variable. In the next step, N (C:N) and P were added followed by other nutrients in the final
657 step.

658 * Due to missing data, soil texture was included in additional analyses on a smaller dataset. Atmospheric factors were not allowed
659 to influence soil texture. ** Pre-selection of atmospheric factors was conducted based on automated model selection procedure.
660

661 **Figure 3 a)** 'Core' SEM depicting the direct (black lines) and indirect (grey lines) influence of different predictors
662 that were hypothesized to be the most important drivers of biomass production. Dotted lines indicate which
663 variables were used in the creation of the composite variable (soil physicochemical properties - pcp) represented
664 by a hexagon. All the paths were significant and factor loadings are indicated for each path. **b)** The most
665 parsimonious model after the addition of N (C:N) and P. **c)** The final SEM after the addition of all nutrients, where
666 the micronutrient composite (mic) was created from Zn and Fe. All models had a good fit based on each of the
667 goodness-of-fit criteria (Table S4).

668
669 **Figure 4** The relationship between the micronutrient composite (based on Zn and Fe) and biomass (\log_e) under
670 different levels of C:N and N deposition; from top-left to bottom-right: low C:N - high N deposition, high C:N - high
671 N deposition, low C:N - low N deposition, high C:N - low N deposition. The median values of C:N and N deposition
672 were taken as thresholds based on which the dataset was split into 4 equal groups. Different colours of the points
673 represent different levels of growing season precipitation (ranging from 160 mm to > 1500 mm per year).

674
675 **Figure 5** The relationship between the micronutrient composite (based on Zn and Fe) and biomass (\log_e) in the subset
676 of NutNet sites (n=38) for which the effect of nutrient additions was assessed by Fay et al. (2015). Linear regression
677 relationship in the soils that were shown to be **a)** N limited (n = 9); **b)** without N limitation (n = 29); **c)** NP co-limited
678 (n = 23); **d)** without NP co-limitation (n = 15).

Biomass [g/m^2]

Precipitation [mm]

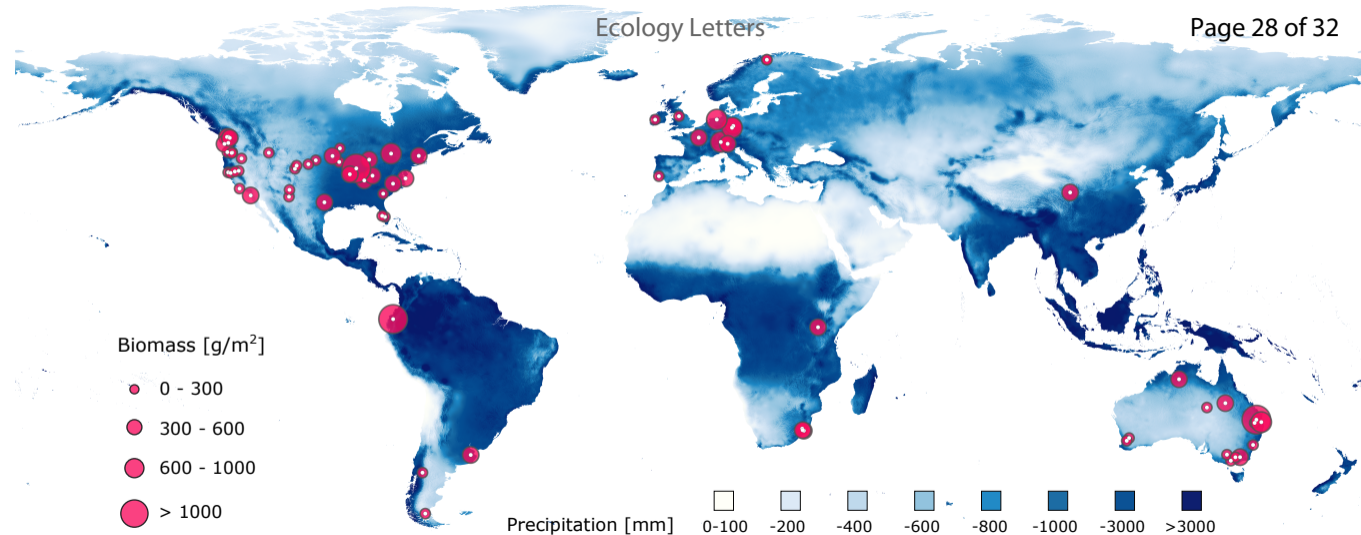
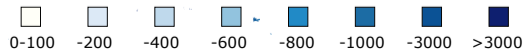

(a)

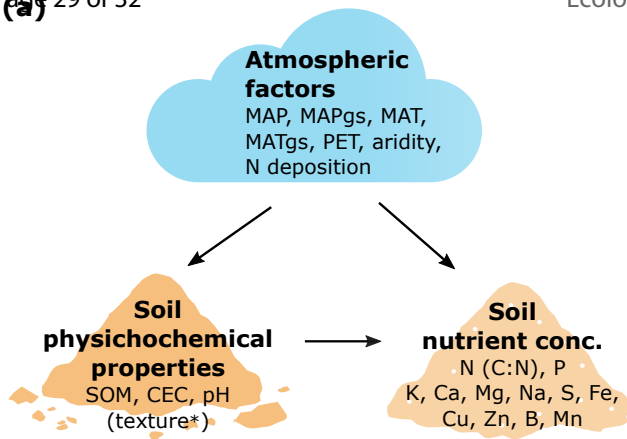

(b)

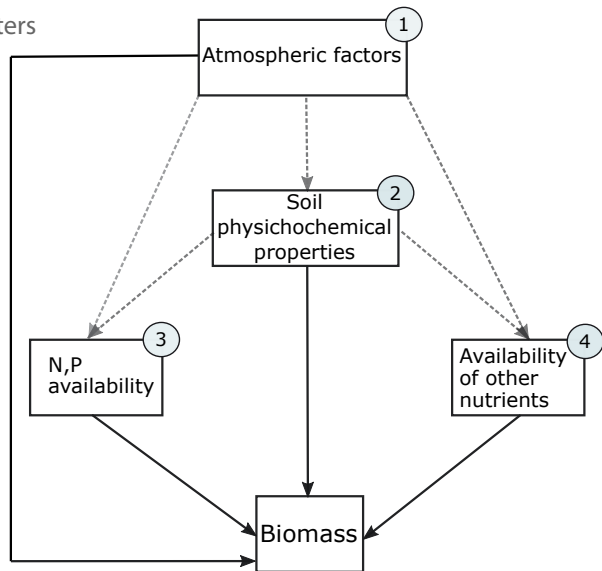

(c)

CORE SEM

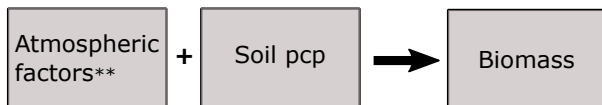

SEM 2

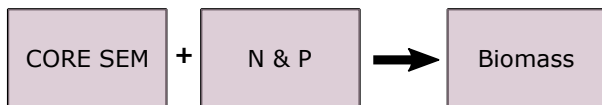

SEM 3

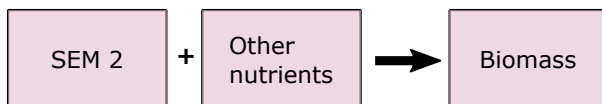

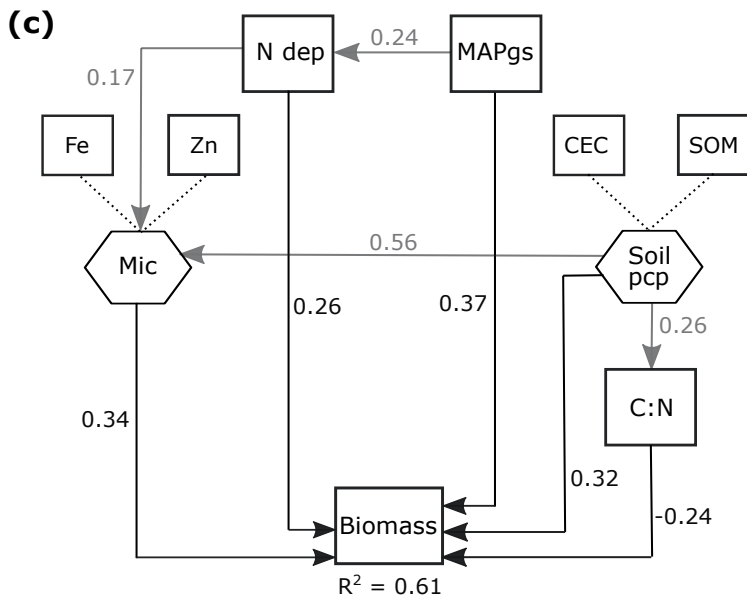
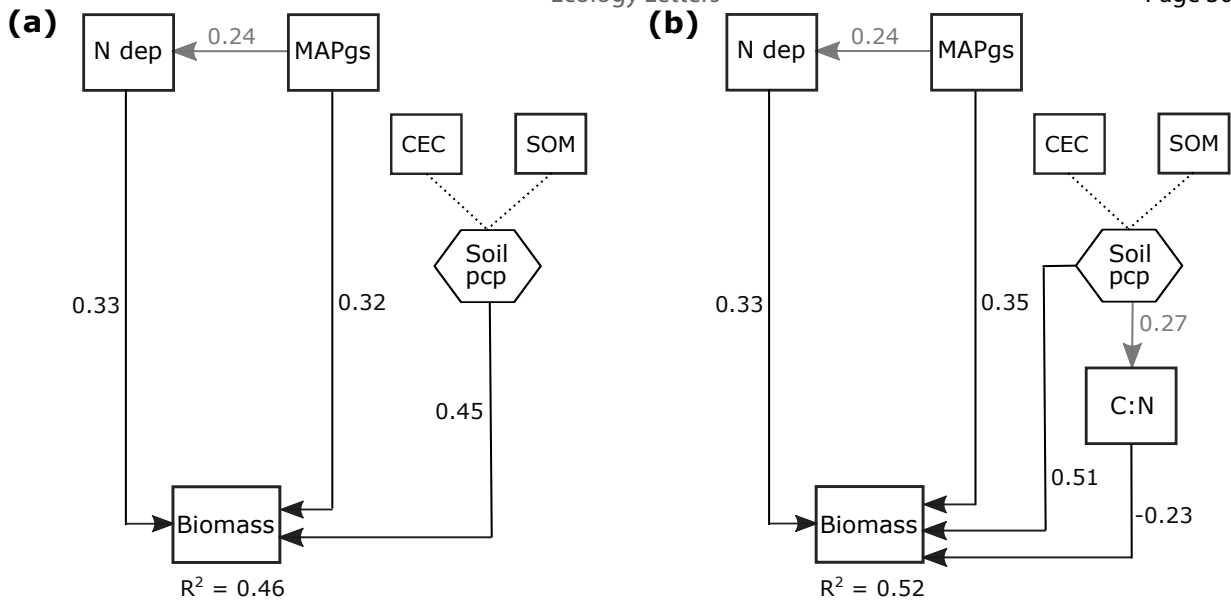

Low C:N

High C:N

High N dep

Low N dep

