



HAL
open science

Optimization of anesthetic procedure in crustaceans: evidence for sedative and analgesic-like effect of MS-222 using a semi-automated device for exposure to noxious stimulus.

Marie-Jeanne Perrot-Minnot, Aude Balourdet, Olivier Musset

► **To cite this version:**

Marie-Jeanne Perrot-Minnot, Aude Balourdet, Olivier Musset. Optimization of anesthetic procedure in crustaceans: evidence for sedative and analgesic-like effect of MS-222 using a semi-automated device for exposure to noxious stimulus.. *Aquatic Toxicology*, 2021, 240, pp.105981. <10.1016/j.aquatox.2021.105981>. <hal-03409464>

HAL Id: hal-03409464

<https://hal.science/hal-03409464v1>

Submitted on 27 Feb 2024

HAL is a multi-disciplinary open access archive for the deposit and dissemination of scientific research documents, whether they are published or not. The documents may come from teaching and research institutions in France or abroad, or from public or private research centers.

L'archive ouverte pluridisciplinaire **HAL**, est destinée au dépôt et à la diffusion de documents scientifiques de niveau recherche, publiés ou non, émanant des établissements d'enseignement et de recherche français ou étrangers, des laboratoires publics ou privés.



HAL Authorization

1
2
3
4
5
6
7
8
9
10
11
12
13
14
15
16
17
18
19

Optimization of anesthetic procedure in crustaceans: evidence for sedative and analgesic-like effect of MS-222 using a semi-automated device for exposure to noxious stimulus.

Marie-Jeanne Perrot-Minnot ^{a,*}, Aude Balourdet ^a, Olivier Musset ^b

^a Biogéosciences, UMR 6282 CNRS, Université Bourgogne Franche-Comté, 6 Boulevard Gabriel, 21000 Dijon, France

^b Laboratoire Interdisciplinaire Carnot de Bourgogne, UMR 6303 CNRS, Université Bourgogne Franche-Comté, 9 av. A. Savary, 21078 Dijon, France

* Author for correspondance
Biogéosciences, UMR 6282 CNRS, Université Bourgogne Franche-Comté
6 Boulevard Gabriel, 21000 Dijon, France
mjperrot@u-bourgogne.fr, Tel 33 3 80 39 63 40 / Fax33 3 80 39 62 31

20 **Abstract**

21 The implementation of anesthetic procedure in aquatic crustaceans remains mostly limited to
22 studies dealing with sedation and survival from anesthesia, possibly owing to the debated
23 question of pain in invertebrates . However, two important issues are generally overlooked:
24 actual analgesic-like effect, and possible physiological post-anesthetical effects. Here we
25 report on the anesthetic properties and possible after-effects of MS-222 (Tricaine
26 Methanesulfonate or Ethyl 3-aminobenzoate methanesulfonate) and Eugenol in the freshwater
27 amphipod *Gammarus pulex*. We first optimized the concentration of MS-222, and the
28 induction and recovery time, based on preliminary tests and published studies. We then relied
29 on the nociceptive modulation of sheltering behavior to assess the analgesic-like effect of the
30 two drugs, using a new semi-automated electric shock device. In addition, we monitored the
31 impact of anesthesia with MS-222 on locomotor activity and oxygen consumption and
32 addressed potential adverse effects upon recovery using biomarkers related to metabolism and
33 neurotoxicity. We provide evidence for the sedative and analgesic-like effects of MS-222 at
34 600 mg. L⁻¹ and, to a lesser extent, of Eugenol at 100 µL. L⁻¹, with no decrease in survival rate
35 at 6 days post anesthesia. Oxygen consumption was reduced -but not eliminated- under full
36 anesthesia with 600 mg. L⁻¹ MS-222. No significant physiological effect of anesthesia was
37 evidenced on the activity of the mitochondrial electron transfer system, or that of
38 acetylcholine esterase, nor on total antioxidant capacity. We therefore conclude to the
39 efficiency of MS-222 as an anesthetic drug in *G. pulex*. Eugenol should be tested at a higher
40 concentration to reach the same efficiency, providing that increased concentration would not
41 incur side-effects. Furthermore, the new and original semi-automated electric chock device
42 used to induce nociception can be easily adapted to any species of aquatic invertebrates and
43 small-sized fish and tadpoles, offering a standardized and flexible protocol to study
44 nociceptive response and anesthesia in aquatic organisms.

45

46 Key words: Benzocaine - Metabolism - Refuge-use - Respirometry - Trolox-Equivalent-
47 Antioxidant-Capacity - Surgery

48

49 **Introduction**

50 Aquatic crustaceans are commonly used as sentinel organisms for environmental
51 assessment of sublethal toxicity. At the cellular and molecular levels, the use of biomarkers of
52 stress response and toxicity may rely on stressful or invasive laboratory procedures to collect
53 hemolymph, organs such as gonads or hepatopancreas, or stem cells (Kunz et al. 2010; Rosner
54 et al. 2021). The implementation of such procedures potentially raises a welfare issue as
55 generally advocated for wild animals, including invertebrates (Soulsbury et al. 2020). This
56 issue should be addressed in a sound and balanced manner based on growing scientific
57 evidence about nociception and pain in crustaceans (Browman et al. 2019; Diggles, 2019;
58 Elwood, 2019; Walters, 2019). From a pragmatic point of view, the development of an
59 anesthesia protocol in crustacean research constitutes a cautionary approach and, at the same
60 time, may contribute to knowledge about nociception or pain. Whether a pain-centered
61 approach or a pragmatic approach to crustacean welfare is adopted, it should lead to the
62 design and report of ‘appropriate’ anesthetic procedures (Browman et al. 2019; Soulsbury et
63 al. 2020; Stanley et al. 2020). Such reporting is still anecdotal, with less than 0.2% of
64 articles recorded in the Web of Science for the past 20 years on crustacea* and either
65 hemolymph, tissue, brain or caecum, including anesthe* as topic keyword (on Jan. 29, 2021).

66 The implementation of anesthetic procedures in invertebrates has been limited so far
67 by a lack of both regulation and technical solutions (Li et al. 2018), despite several reviews on
68 anesthesia in Invertebrates (Coyle et al. 2004; Cooper, 2011). A definition of anesthesia
69 generalizable to all living organisms has been recently proposed, as "the isolation of an

70 organism from its environment—both in terms of the afferent arm of sensation and the
71 efferent arm of action—" (Kelz and Mashour, 2019). Endpoints of general anesthesia in
72 medical science encompass amnesia, analgesia, immobility, and unconsciousness (Kelt and
73 Mashour, 2019), the first three being concomitantly applicable to most living forms. Yet, most
74 studies on crustaceans evaluate anesthetic procedure from mobility tests and response to
75 mechanical stimulus (Coyle et al. 2004; Cooper, 2011) (Table A.1.), without further
76 assessment of analgesia. In addition, the study of after-effects of anesthesia on crustaceans is
77 generally limited to recording survival (Table A.1.). Hence, two important issues are
78 generally overlooked: actual antinociceptive effect and possible post-anaesthesia toxicity or
79 physiological and behavioral after-effects (Soulsbury et al. 2020).

80 Here, we sought to assess the anesthetic effect of MS-222 (Tricaine methanesulfonate
81 or Ethyl 3-aminobenzoate methanesulfonate), in the freshwater amphipod *Gammarus pulex*,
82 in comparison to Eugenol. The assessment of MS-222 efficiency was complemented by
83 physiological tests to address possible aftereffects. MS-222 is a hydrophilic derivative of
84 Benzocaine, widely used in poikilothermic vertebrates such as fish and amphibians. Its
85 efficiency in general anesthesia, through reversible blockade of sensory and motor nerve
86 activity, has been evidenced at the neuronal and behavioral levels in zebrafish
87 (Ramlochansingh *et al.*, 2019). More recently, Stanley et al. (2020) provided evidence that
88 MS-222 reduces the activity of sensory and motor neurons in crabs, crayfish, and fruitflies.
89 The blockade of voltage-gated Na⁺ channels seems to be the mode of action involved in the
90 depression of synaptic transmission by MS-222 in these invertebrates, as in vertebrates
91 (Stanley et al. 2020). At the whole-organism level, a few studies have reported an anesthetic
92 effect of MS-222 in crustaceans, while others found little or no effect (Coyle et al. 2004;
93 Table A.1.). These contradictory studies on crustaceans recently led to a dismiss of MS-222 in
94 favor of the more widely tested Eugenol (Li et al., 2018; Ghanawi et al., 2019). In addition, no

95 study, to the best of our knowledge, has assessed the analgesic/amnesic effect of MS-222
96 (Table A.1.). Indeed, most studies so far have relied on locomotory or reflex responses (Table
97 A.1.), whereas the blocking of sensory perception and integration of nociception can only be
98 evidenced through aversive behavioral reactions induced by exposure to noxious stimulus.
99 Furthermore, few studies have assessed possible after-effects (Table A.1.)

100 We first established the optimal concentration of MS-222 for sedation by assessing the
101 dose-effect of three concentrations on time to induce sedation and time to recover. We then
102 assessed the analgesic-like effect of MS-222 at optimal concentrations for sedation by
103 exposing anesthetized *G. pulex* to a noxious stimulus and compared it to Eugenol. Acute
104 noxious stimulation was induced by exposure to electric shocks, based on previous studies
105 reporting behavioral responses consistent with pain (reviewed in Elwood, 2019). Indeed,
106 exposure to electric shock is enhancing protective or withdrawal behavior in crustaceans in a
107 way consistent with induced anxiety-like state (Fossat et al. 2014; Perrot-Minnot et al 2017),
108 and avoidance learning (reviewed in Elwood, 2019). To that aim, we designed a new and
109 cost-effective semi-automated device to standardize exposure to electric shocks (ES). The
110 frequency of refuge use after exposure to electric shocks under anesthesia was taken as the
111 behavioral endpoint for analgesia-like effect. We expected that if these compounds have an
112 anesthetic effect in *G. pulex*, individuals exposed to ES under anesthesia should not express
113 the enhanced protective behavior induced by ES-exposure as observed in non-anesthetized
114 individuals (increased use of refuge). We further monitored the temporal changes in mobility
115 and metabolic rate under MS-222 exposure, during both induction and recovery periods. The
116 locomotor activity and oxygen consumption rate (respirometry assay) of gammarids were
117 measured using automated devices.

118 Finally, we addressed whether MS-222 and Eugenol could induce immediate
119 physiological after-effects, more specifically on whole-organism cellular respiration capacity,

120 antioxidative capacity and neurotransmission. We focused on these possible changes in
121 metabolic/oxidative status and neurotoxicity driven by anesthesia, based on previous studies
122 on crustaceans following exposure to Eugenol (Saydmohammed and Pal, 2009) and on fish
123 exposed to MS-222 or Eugenol (Olsen and Christensen, 1980; Teles et al. 2019).

124

125 **2. Material and methods**

126 All gammarids *G. pulex* were collected in Val Suzon (Burgundy, France: 47.40°N, 4.88°E)
127 and sorted on-site to keep only males ranging in size from 0.8 to 1.2 cm length (estimated by
128 eye). Fresh weight of gammarids was 37 mg on average (SD=9.45, N=309). Gammarids were
129 allowed to acclimate for at least one week prior to onset of experiments, in tanks filled with
130 oxygenated dechlorinated ultraviolet (UV)-treated tap water mixed with water and rocky
131 substrate from the Val Suzon river ('conditioned' water, hereafter abbreviated as CW). The
132 acclimatization of gammarids and the experiments were done in a temperature- and
133 photoperiod-controlled room (16°C, UV, 12 L: 12 D, under 800 Lux illumination).

134

135 *2.1. Optimization of anesthetic procedures with MS-222 and Eugenol based on sedative effect.*

136 Preliminary tests with MS-222 were undertaken to assess its dose-dependent sedative effect,
137 as well as optimal induction and recovery times. We prepared the anesthetic solution fresh by
138 dissolving MS-222 (Sigma-Aldrich E10521) in CW, at three concentrations, 500, 600 and 700
139 mg. L⁻¹. These test concentrations were chosen based on previous studies (Table A.1), and
140 preliminary assays. Gammarids were immersed individually in MS-222 bath to monitor
141 induction time, and in CW to monitor recovery time. Criteria for induction of full sedation
142 was immobility, the lack of escape reaction to a gentle touch with a brush (a common tactile
143 stimulation method employed in most studies, Table A.1.), and interruption of pleopod
144 beating. Criteria for full recovery was the resumption of these motor activities. To assess full

145 recovery of locomotion, we compared the locomotor activity of anesthetized gammarids to
146 unanesthetized ones at 50 min post recovery. The locomotor activity was monitored using an
147 automated recording device, including a lighting infrared system and an infrared camera
148 connected to a laptop for videorecording (Zebralab software, View Point, Lyon, France).
149 Individual activity was recorded during 15 min in a 9 cm petri dish filled with CW, under low
150 light intensity corresponding to twilight illumination (100 lux). Three velocity thresholds
151 were initially set to quantify locomotor activity according to the speed of motion: below 7
152 mm.sec⁻¹ for inactivity (motionless, but including pleopod beating), between 7 and 15
153 mm.sec⁻¹ for slow movements (crawling), and above 15 mm.sec⁻¹ for swimming. Activity was
154 scored as the proportion of time spent motionless or swimming during 15 min

155 We adjusted Eugenol concentration, induction, and recovery times by running a pilot
156 study and using previously published data (with a dose range of 30 to 1000 mg (μL) L⁻¹
157 recommended for crustaceans, Darbyshire et al. 2019). Our preliminary observations showed
158 that the concentrations used by Venarsky and Wilhem (2006) on *Gammarus minus* were too
159 low to induce a decrease in motor activity in *G. pulex*. Based on both the study of Li et al.
160 (2018) on small shrimps, and preliminary assays, we decided to set the concentration at 100
161 μL (mg). L⁻¹. A stock solution of Eugenol (Fluka, 46129) was prepared at 10% in EtOH (100
162 μL in 900 μL EtOH), thoroughly mixed, and then diluted in one liter of CW to reach the final
163 concentration. Preliminary observations using the same criteria for sedation as above were
164 done to adjust induction and recovery times at 30 and 50 min respectively (exp. 1) and 45 and
165 70 min respectively (exp. 2).

166

167 2.2. Exposure to noxious stimulus: electric shock device

168 The objective in designing the experimental set-up was to expose individual gammarids to a
169 homogeneous and accurately reproducible electric field in the same arena as the one used to

170 record behavior. The device must be simple, flexible, robust, and inexpensive, to allow testing
171 several individuals simultaneously under repeatable conditions. Applied voltage, the number
172 and duration of each pulse, and total duration should be adjustable by the experimenter. We
173 met these specifications by adopting a DIY (“Do-It-Yourself”) engineering approach through
174 a three-steps workflow: the mechanical and electronic assembly of the blocks holding
175 electrodes and plugs (hereafter referred to as ‘ES-chamber’), the validation of the device by
176 performing electrical measurements, and the design of electronic driver and PC-software
177 (control module) to allow simple and complete control of the system.

178 2.2.1 Mechanical assembly

179 The ES-chamber was made of a 3D-printed polymer part, which contains the two electrodes,
180 and the electrical connections to the control module (Fig. 1a, 1b). The block was printed using
181 a water-repellent and non-toxic PET-G polymer from Neofil® and Ultimaker® heating wire
182 3D printer. The electrodes were made from metal sheets (1mm thick) of tinned copper
183 (usually used to make electromagnetic shielding), cut to the size matching the entire interior
184 wall of the block lengthwise ($95 \times 27 \text{ mm}^2$). The swimming area was limited inside by fixing
185 two thin perpendicular polymer walls (Fig. 1a, 1b). This geometry avoided edge effects and
186 thereby large variations in the electric field in the swimming area. The device was designed to
187 fit into the arena used for refuge use experiment ($10.5 * 16 \text{ cm}$ rectangular box: Fig. 1c).

188 2.2.2 Electrical measurements

189 We first measured water resistance using two samples of water either directly from tap water
190 or from laboratory water (CW). We then measured the voltage / current characteristic for
191 different distances between electrodes and for three voltages applied to the terminals of the
192 electrodes ($\Delta V=8, 12$ and 16V). Figure 2 shows the results obtained for tap water. As
193 expected, the characteristic of the resistance was proportional to the distance between the
194 electrodes.

195 The measured resistance in tap water and in filtered and treated water from the
196 laboratory was 0.19k Ω /cm and 0.15k Ω /cm respectively (0.95 Ω and 0.75k Ω for a 5cm-
197 distance between electrodes in the final device). The dissipated power was calculated using
198 the product between voltage (ΔV) and current (I) with the well-known relation $P=\Delta V \cdot I$. For a
199 voltage $\leq 12V$ and 5cm between electrodes, the maximum power P_{\max} was thus estimated at
200 0.20W, which is negligible for the volume of water considered. One last issue to address was
201 metal contamination in the water due of the electrolysis of the electrodes. To reduce this
202 potential hazard, short-time electric pulses were delivered (a few seconds to a few tens of
203 seconds) and the water was changed between each exposure. Under these operating
204 conditions, the risk of contamination of the water by electrolysis of the electrodes was made
205 negligible.

206 The homogeneity of the electric field was checked by measuring with a voltage probe
207 the electric potential difference with respect to the electrode connected to the reference
208 potential (designed as ground). The voltage difference ΔV was then plotted as a function of
209 the position in the swimming zone, and the electric field calculated by applying the relation E
210 $= -\text{grad } \Delta V$ (Fig. 3). To the maximum voltage of 12V corresponded a value of ΔV of about
211 2.40V/cm.

212 2.2.3 Electronic driver and PC-software

213 The electronic driver of the experimental setup was designed to allow easy configuration. The
214 12 ES-chambers were operated from 12 channels split into three independent groups (Fig. 4a).
215 For each group of four channels, the experimenter could choose applied voltage and electric
216 pulses parameters (pulse duration, number of pulses, total time). The electronic assembly
217 included an Arduino MEGA[®] module connected to a small LCD screen, a board for shaping
218 the excitation voltages, and three relay switch boards with four relays each. The configuration

219 was carried out by in-house software produced under Visual basic, and accessible via a PC
220 through a simple USB port and a user-friendly interface (Fig. 4b).

221

222 *2.3. Anesthetic effect of MS-222 and Eugenol: behavioral response following exposure to ES*

223 We applied a fully crossed design to assess the behavioral effects of anesthetic procedures and
224 exposure to electric shocks on refuge use. All individuals were manipulated in the same way
225 and same duration, whether they were exposed to ES or not (placed in ES-chambers with or
226 without electric current), under anesthesia or not (bathed in anesthetic solution or in CW).

227 Gammarids were anesthetized in pools of 10 individuals by immersion in 250 mL
228 anesthetic solution in plastic food containers at 16°C, for 45 min (MS-222 at 600 mg. L⁻¹) or
229 30 and 50 min (Eugenol at 100 µL. L⁻¹). Following induction of anesthesia, gammarids were
230 rinsed and transferred immediately as individuals to refuge boxes equipped with one ES-
231 chamber and filled with 250 mL CW. For individual exposure to ES, we relied on preliminary
232 tests and a previous study (Perrot-Minnot et al. 2017) to set a fixed configuration at ten pulses
233 of 12V and 2 sec. each, for a total duration of 3 min. Exposure to ES was performed on half
234 gammarids anesthetized with MS-222 or Eugenol, and half gammarids not anesthetized
235 (controls). The other half, for each anesthetic treatment and controls, were placed in ES-
236 chamber without current. After exposure to electric shocks, ES-chambers were removed, and
237 gammarids were left to fully recover from anesthesia (MS-222: 50 min, Eugenol: 50 or 70
238 min). During that time, a refuge (half a terracotta saucer: Fig. 1c) was placed in the middle of
239 the box for the gammarid to become familiar with while recovering. At the end of recovery
240 time, the refuge was placed at few millimeters from the box wall (Fig. 1c), and gammarids
241 were left to acclimatize for 5 min. We then quantified refuge use by scoring the position of
242 individual gammarids every 30 s for 10 min, giving a score range from 0 to 20. Refuge use

243 was reported as a frequency by dividing as the number of times individual gammarids were
244 under refuge by the maximum score (20).

245

246 *2.4. Monitoring changes in metabolic rate and locomotor activity during induction of* 247 *sedation with MS-222 and during recovery*

248 We monitored the decrease in locomotor activity during induced sedation, and the progressive
249 resumption of locomotor activity during recovery in CW, using the Zebralab automated
250 device (see 2.1. above). We split the 44 min- recording time in four bins of 11 min to capture
251 the temporal changes in activity. The same three velocity thresholds were used to quantify
252 locomotor activity according to the speed of motion: below 7 mm.sec⁻¹ for inactivity
253 (motionless, but including pleopod beating), between 7 and 15 mm.sec⁻¹ for slow movements
254 (crawling) and above 15 mm.sec⁻¹ for swimming. Activity was scored as the proportion of
255 time spent motionless or swimming during each bin of 11 min

256 Metabolic capacity at the organismic level was quantified by measuring oxygen
257 consumption using Sensordish optical fluorescence-based respirometry (Presens, Regensburg,
258 Germany), following protocols previously outlined in Perrot-Minnot et al. (2014). Briefly, we
259 recorded the oxygen consumption rate of gammarids placed individually in 3.4 mL-well
260 equipped with O₂ sensor (24-well microplates of 1.7 cm in diameter, batch OD-1142-01
261 calibrated at 16°C). Gammarids were introduced in wells filled to the top with either MS-222
262 or CW (anesthesia) or CW (recovery) and left to acclimatize for 1 min prior to sealing the
263 microplate with parafilm and cover, and immediate recording under near darkness at 15°C.
264 Two wells, filled in the same way but without gammarid, were included per plate to control
265 for possible changes in [O₂] independent of gammarid respiration. Oxygen concentration was
266 measured at 15 s intervals during 44 min using oxygen meter (SDR v. 4 SensorDish Reader;
267 Presens). We subtracted O₂ concentration in experimental wells to the mean value of the two

268 control wells at the same time, to calculate the decline in O₂ concentration due to respiration
269 (ΔO_2 in mg. L⁻¹). We then derived O₂ consumption rate (in $\mu\text{g O}_2 \text{ min}^{-1}$) from the slope of the
270 linear regression of ΔO_2 multiplied by well volume (3.4 mL), on time. Two separate groups of
271 gammarids were used to record oxygen consumption rate during anesthetic bath and during
272 recovery in CW, to avoid prolonged stay in the apparatus and decrease in dissolved [O₂]
273 below 5 mg. L⁻¹. Slight movement of gammarids in this static respirometry device likely
274 contributed to the homogenization of O₂ concentration in the well. Because the O₂ sensor is
275 placed in the middle of the well bottom and smaller than its diameter, the value of O₂
276 concentration measured at the sensor represents the actual concentration in the whole water
277 volume if the water in the well is mixed by some kind of movement (stirring or individual
278 movement inside the well). Consequently, motion-induced homogenization of O₂
279 concentration occurred at a level depending on locomotor activity. We therefore split the 44
280 min- recording time in bins of 11 min to match the monitoring of locomotor activity (see
281 above).

282 Following respirometry measurements, each gammarid was quickly blotted on a paper
283 towel and weighed to the nearest 0.01 mg using an analytical balance (Precisa 262SMA-FR,
284 Precisa Instruments, Bisingen, Switzerland). For statistical analysis, we divided O₂
285 consumption rate (in $\mu\text{g O}_2 \text{ min}^{-1}$) for gammarid's weight (log₁₀), based on the log-log
286 relationship between metabolic rate and weight known as metabolic scaling (Glazier, 2005).

287

288 *2.5. Survival and physiological consequence of anesthesia with MS-222-and eugenol:*

289 *markers of cellular aerobic metabolism, oxidative stress and neurotoxicity*

290 We assessed the effect of exposure to MS-222 and Eugenol on physiological parameters of
291 whole organism just after 50 min and 70 min recovery from anesthesia, respectively. The total
292 protein content, ETS activity, antioxidant potential (Trolox equivalent antioxidant capacity

293 (TEAC) assay), and AChE, were estimated in supernatant from individual sample, using
294 colorimetric assays (Appendix B). We assessed the survival of gammarids six days following
295 a single anesthesia in MS-222 (600 mg. L⁻¹, 45 min) or in Eugenol (100 µL. L⁻¹, 45 min).
296 Gammarids were either anesthetized or left in CW (controls) in pools of 8 to 10 individuals in
297 250 mL plastic food container, rinsed, and maintained for six days in boxes filled with CW,
298 with decaying elm leaves as food and rocks as refuge (N = 67 to 73).

299

300 *2.7. Statistical analysis*

301 All analysis were done with R-Studio, version 1.3.1073 (RStudio Team, 2020). When running
302 generalized linear models, we visualized the distribution of response variable a priori, and
303 checked model assumptions a posteriori by visual inspection of diagnostics plots (package
304 “ggResidpanel” v. 0.3.0., Goode and Rey, 2019) (Zuur et al., 2010). Whenever normality
305 assumption or homogeneity of variance assumptions were violated, we used non-parametric
306 tests.

307 We run an ordinal linear regression to analyze MS222 dose effect on induction time,
308 and recovery time (log-transformed). We performed Tukey post hoc tests to do paired
309 comparison between concentrations.

310 We relied on non-parametric tests to compare locomotor activity and oxygen
311 consumption rate between treatment at each time-bin, and for each treatment, between time
312 bins. At each time-bin, we compared the proportion of time spent at each speed level and the
313 oxygen consumption rate between treatment, using Wilcoxon tests. We analyzed change in
314 locomotor activity and [O₂] consumption rate across time bins within treatment using the
315 Friedman test followed by pairwise comparisons using Nemenyi post-hoc test (package
316 PMCMR v. 4.3; Pohlert 2014).

317 We analyzed refuge use according to anesthetic treatment and exposure to ES, using
318 Kruskal-Wallis test followed by pairwise comparisons with BY correction, and reported the
319 associated Z-statistic and adjusted p-value (Package dunn.test, v1.3.5; Dinno 2017). In
320 addition, we estimated the effect size of exposure to ES on refuge use according to anesthetic
321 treatment, by using the Cliff's delta index, following Perrot-Minnot et al. (2014). Based on
322 the threshold values for the Cliff's delta reported in Romano et al. (2003) the magnitude of
323 effect sizes was interpreted as negligible (less than 0.147), small (between 0.147 and 0.33),
324 medium (between 0.33 and 0.474), or strong (more than 0.474).

325 We compared the survival of gammarids according to anesthetic treatment (MS-222,
326 Eugenol and controls) using the Fisher exact-test on pooled replicates. Survival Odds were
327 calculated for all three groups (MS222, Eugenol and controls) as the probability of death on
328 probability of survival, and Odd ratio were calculated as the ratio of odds of one anesthetic on
329 the odd of the control. We run linear mixed-effects model to analyze the effect of anesthesia
330 on physiological parameters. For total protein content, fixed factors were anesthetic treatment,
331 gammarid wet weight (mg) and interaction between treatment and weight, and plate number
332 was incorporated as random factor. For ETS activity, TEAC and AChE, fixed effects were
333 anesthetic treatment, total protein content and interaction between treatment and protein
334 content, with plate number as random factor. A posteriori multiple pair comparison was done
335 using Tukey test with Westfall correction for multiple comparisons (see Appendix B for
336 detailed analysis).

337

338 **3. Results**

339 *3.1. Optimization of anesthetic procedures with MS-222 based on sedative effect*

340 Induction time decreased with increasing concentration of MS-222 ($F_{2,68} = 12.65$; $P < 0.0001$;
341 $R_{adj.} = 0.25$; Fig. 5). Sedative state was reached at a significantly later time at 500 mg. L⁻¹

342 compared to 600 and 700 mg. L⁻¹ (Tukey post-hoc tests: $P_{\text{adj}} = 0.0005$ and $P_{\text{adj}} < 0.0001$,
343 respectively). Conversely, recovery time in CW increased with increasing concentration of
344 MS-222 during anesthesia ($F_{2,68} = 13.54$; $P < 0.0001$; $R_{\text{adj.}} = 0.26$; Fig. 5). Paired comparisons
345 of recovery time were all significant (Tukey post-hoc tests: 500-600: $P_{\text{adj}} = 0.014$; 500-700: P
346 $_{\text{adj}} < 0.0001$; 600-700: $P_{\text{adj}} = 0.03$). Therefore, we choose the concentration of 600 mg. L⁻¹ as
347 the best compromise to minimize both induction and recovery times. We set the induction
348 time to 45 min to get the maximum number of individuals under full sedation, and the
349 recovery time at 50 min considering that most manipulation following recovery would take 5
350 to 10 additional minutes.

351 Gammarids anesthetized with MS-222 at 600 mg.L⁻¹ for 45 min resumed swimming
352 activity at a comparable level to unanesthetized ones after 50 min of recovery in CW (Fig. 6:
353 Wilcoxon test: $W = 372$, $N = 60$, $P = 0.37$). No significant difference in time spent in
354 intermediate locomotion was observed between anesthetized and control gammarids ($W =$
355 510 , $N = 60$, $P = 0.24$).

356

357 *3.2. Anesthetic effect of MS-222 compared to eugenol: refuge use following exposure to*
358 *noxious stimulus.*

359 Refuge use by gammarids differed across anesthetic treatment and ES exposure, for each of
360 the three experiments (MS-222: Kruskal-Wallis $\text{Chi}^2 = 47.62$, $\text{df} = 3$, $P < 0.0001$; Eugenol
361 30-50, $\text{Chi}^2 = 9.99$, $\text{df} = 3$, $P = 0.02$; Eugenol 45-70; Kruskal-Wallis $\text{Chi}^2 = 21.64$, $\text{df} = 3$, $P <$
362 0.0001). In unanesthetized gammarids, refuge use 50 min and 70 min after the electric shock
363 increased compared to controls (unexposed to ES) in all three experiments (MS-222, $Z =$
364 5.87 , $P < 0.0001$; Eug. 30-50, $Z = 3.13$, $P = 0.01$; Eug. 45-70, $Z = 3.15$, $P = 0.004$,
365 respectively) (Fig. 7a, 7b).. Refuge use of gammarids not exposed to ES did not differ,

366 independently of whether they were anesthetized or not, thereby showing no side effect of
367 anesthesia per se on refuge use.

368 The level of refuge use of gammarids anesthetized with MS-222 and exposed to ES
369 was significantly lower compared to unanesthetized gammarids exposed to ES ($Z = 5.07$, $P <$
370 0.0001 ; Fig. 7a). It was comparable to that of anesthetized gammarids not exposed to ES ($Z =$
371 -0.67 , $P = 0.74$). Anesthesia in Eugenol for 30 min only partly mitigated the effect of ES on
372 refuge use. Anesthetized gammarids exhibited an intermediate level of refuge use 45 min after
373 exposure to ES, with no significant difference with anesthetized gammarids not exposed to ES
374 ($Z = -1.77$, $P = 0.11$) and unanesthetized gammarids exposed to ES ($Z = 1.82$, $P = 0.17$) (Fig.
375 7c). The level of refuge use of gammarids anesthetized with Eugenol for 45 min and exposed
376 to ES was significantly lower 70 min later, compared to unanesthetized gammarids exposed to
377 ES ($Z = 3.3$, $P = 0.035$) and was comparable to that of anesthetized gammarids unexposed to
378 ES ($Z = -1.94$, $P = 0.1$; Fig. 7a).

379 The effect size of exposure to ES on sheltering behavior was negligible and not
380 different from null in gammarids anesthetized in MS-222, low in gammarids anesthetized in
381 eugenol for 45 min, and moderate in gammarids anesthetized in eugenol for 30 min (Fig. 8). It
382 was strong in unanesthetized gammarids, 50 min post exposure to ES (pooled controls from
383 MS-222 and Eug. 30-50 experiments) and 70 min post exposure to ES (controls from Eug. 45-
384 70 experiment).

385

386 *3.3. Changes in locomotor activity and metabolic rate during induction of sedation with MS-*
387 *222 and during recovery*

388 **Activity**

389 Locomotor activity of control gammarids in CW was regular throughout the 44 min-recording
390 period (Friedman test: proportion of time motionless, $\text{Chi}^2 = 1.13$, $\text{df} = 3$, $P = 0.77$; proportion

391 of time swimming, $\text{Chi}^2 = 1.73$, $\text{df} = 3$, $P = 0.63$; Fig.9 a, d, g), whereas that of gammarids in
392 MS-222 decreased through time (Friedman test: proportion of time motionless, $\text{Chi}^2 = 67.03$,
393 $\text{df} = 3$, $P < 0.0001$; proportion of time swimming, $\text{Chi}^2 = 68.08$, $\text{df} = 3$, $P < 0.0001$).
394 Gammarids in MS-222 sharply reduced swimming within the first 22 min by switching to
395 moderate locomotion and immobility (Fig.9 b,e,h: Bin A, B; Fig. A2). A sharp increase in
396 time spent motionless occurred after 33 min in MS-222, with half of the gammarids spending
397 more than 90% time motionless during the last bin (Fig. 9b). Gammarids recovering from
398 MS-222 progressively increased their activity (Friedman test: proportion of time motionless,
399 $\text{Chi}^2 = 12.99$, $\text{df} = 3$, $P = 0.005$; proportion of time swimming, $\text{Chi}^2 = 28.15$, $\text{df} = 3$, $P <$
400 0.0001). Locomotor activity at intermediate speed was quickly resumed during the first 11
401 min of recovery (Fig.9 (f) Bin A compared to (e) Bin D), by sharply decreasing time
402 motionless (Fig. 9 (c) Bin A compared to (b) Bin D). However, the recovery of swimming
403 activity was more progressive, as the proportion of time spent swimming was still slightly
404 below controls after 44 min recovery time (Fig. 9 g, i: Bin D).

405

406 **Metabolic rate**

407 Oxygen consumption rate of gammarids in MS-222 was comparable to that of controls during
408 the first three time-bins. It increased significantly during the last one (from 33 to 44 min),
409 when most gammarids in MS-222 were motionless (Fig 10b). There was a trend for the
410 oxygen consumption rate of gammarids in CW (controls) to decrease through time (Friedman
411 test, $\text{Chi}^2 = 39.37$, $\text{df} = 3$, $P < 0.0001$), especially during the first 22 min (Bins A-B: $P =$
412 0.005). The pattern was different for gammarids in MS-222, as O_2 consumption rate first
413 decreased during 22 min but then tended to slightly increase (Friedman test: $\text{Chi}^2 = 24.73$, df
414 $= 3$, $P < 0.0001$; Bin A-B: $P = 0.0001$, Bins B-D: $P = 0.0002$) (Fig. 10). During recovery in
415 CW, the oxygen consumption rate of gammarids anesthetized MS-222 was lower than that of

416 controls during the firsts 0-11 min and then higher during the last one (33-44 min; Fig. 10).
417 Again, there was a trend for the oxygen consumption rate of gammarids in CW (controls) to
418 decrease with time (Friedman test: $\text{Chi}^2 = 50.37$, $\text{df} = 2$, $P < 0.0001$; all paired comparisons
419 significant at $P < 0.03$). Oxygen consumption rate of gammarids in MS-222 was low and
420 stable during the first 22 min, and then increased (Friedman test: $\text{Chi}^2 = 11.74$, $\text{df} = 2$, $P =$
421 0.003 ; Bin A-C, $P = 0.007$, Bin B-C, $P = 0.01$; Fig. 10). Overall, the comparison of O_2
422 consumption rate of gammarids incubated in MS-222 to that of controls was limited by
423 reduced O_2 mixing due to the absence of activity by anesthetized gammarids in the static
424 respirometry device, particularly during the second half of the induction period and the first
425 half of the recovery period. However, low consumption rate under full sedation was still
426 evidenced during the last 11 min anesthesia and the first 11 min of recovery.

427

428 *3.4. Survival and physiological markers of cellular metabolism, oxidative stress and*
429 *neurotoxicity, after anesthesia in MS-222 and Eugenol*

430 Total protein content increased linearly with gammarid's wet weight, with no effect of
431 treatment or of the interaction between treatment and weight. All three biomarkers, ETS
432 activity, TEAC and AChE activity, were positively related to total protein content (Appendix
433 B). The activity of ETS in gammarids recovering from anesthesia was higher after Eugenol
434 bath compared to MS-222 bath, but none of these treatments differed from controls. Total
435 antioxidant capacity (TEAC) and AChE activity were comparable between anesthetic
436 treatments (Appendix B).

437 Six days after anesthesia, most gammarids were still alive (Controls: 97.1%, N=68,
438 MS-222: 93.2%, N=73; Eugenol, 86.6%, N=67). Survival rate was comparable across
439 anesthesia treatments (Fisher exact test: $P = 0.07$), although slightly lower for gammarids

440 exposed to Eugenol. The Odd ratio of mortality due anesthesia with MS-222 and Eugenol
441 compared to controls were 2.42 and 5.12, respectively.

442

443 **Discussion**

444 To our knowledge, this is the first study to provide experimental evidence for actual
445 analgesic-like effects of both MS-222 and Eugenol in aquatic crustaceans. Using standard
446 criteria for sedation level and a new paradigm to assess antinociceptive effect, we evidenced
447 here the efficiency of MS-222 and, to a lesser extent, of Eugenol, in the freshwater amphipod
448 *G. pulex*. The use of “do it yourself engineering” enabled the design and manufacture of ES-
449 chambers and electronic driver offering both flexible and standardized manipulation.

450 We observed a dose-effect of MS-222 on induction of full sedation and on recovery
451 time, as reported in other studies reviewed here on MS-222 and Eugenol. The efficiency of
452 MS-222 at 500 to 700 mg. L⁻¹ has been previously reported in five out of eight studies on
453 crustaceans but with contrasted induction and recovery times. More specifically, the effective
454 concentrations of MS-222 matches the range of effective concentrations reported for *G. pulex*
455 by Ahmad (1969), although the comparison is not directly possible due to different assay
456 temperatures. However, extrapolating to the dose- and temperature- dependent induction time
457 reported by this author (p. 198), sedation at 600 mg. L⁻¹ should be reached in approximately
458 50 min at 14-15°C, which is close to the induction time found here. By contrast, recovery
459 time following immediate transfer to freshwater was much longer here (50 min) compared to
460 the one reported by Ahmad (1969) at an even higher dose (16 min at 14-15°C, 800 mg. L⁻¹).
461 Sedative effect of Eugenol also confirms previous studies on crustaceans, but with variable
462 induction and recovery time as well. Induction time of sedation in Eugenol at 100 µL. L⁻¹ (30
463 to 45 min) was slightly longer than the one reported for small shrimp at the same
464 concentration and temperature (20 min in Li et al. 2018), but full recovery was reached sooner

465 (70 min compared to approx. 100 min in Li et al. 2018). These values are much higher than
466 the ones reported for *G. minus* by Venarsky and Wilhem (2006) at 148 $\mu\text{L. L}^{-1}$, what could be
467 due to testing at different temperature (15°C here, versus 20°C), and to the criteria used to
468 assess full sedation and recovery. To assess more accurately the concentration of MS-222
469 needed to induce the desired anesthetic effects at given induction or recovery times, a larger
470 set of concentrations should be tested, and the optimal concentration derived from the best-fit
471 model. The optimal concentration should be determined specifically for the species, body size
472 of individuals, and, possibly, the source population under study.

473 The analgesic-like effect of MS-222 at 600 mg L^{-1} was evidenced in the lack of
474 behavioral response of gammarids exposed to a noxious stimulus under anesthesia compared
475 to unanesthetized ones. Archibald et al. (2019) concluded to a state of “surgical anesthesia”
476 reached with MS-222 based on the lack of response to a mechanical noxious stimulus
477 manually applied to Horseshoe crab (*Limulus polyphemus*). The absence of immediate
478 withdrawal reaction to a noxious stimulus can result from the lack of either nociceptive
479 perception or information processing under anesthesia, or that of motor response to the
480 immediate stimulus (despite perception and processing). By contrast here, we recorded a
481 delayed behavioral response after full recovery from anesthesia and in a context different
482 from the one in which the noxious stimulus had been experienced. We can therefore conclude
483 that the observed phenomenon was not due to motor impairment but resulted from
484 nociception perception or integration. To our knowledge, this study is the first one to report
485 such analgesic-like effect in crustaceans. Future studies should compare the anesthetic
486 efficiency of drugs using behavioral responses that rely on different levels of information
487 processing and integration, such as immediate reflex versus more cognitively demanding
488 behavior. Eugenol at 100 $\mu\text{L. L}^{-1}$ was also effective as an anesthetic but performed slightly
489 less than MS-222 (although the difference in effect size could not be considered as

490 significant). Additionally, it required longer recovery time at the induction time necessary to
491 reach a significant analgesic-like effect. Lower efficiency of Eugenol compared to MS-222
492 (as sedative agents) has been reported by Coyle et al. (2004), while the reverse was found in
493 crabs (Morgan et al., 2001). We did not test Eugenol at higher concentration, as full recovery
494 time was already 40% longer than that of MS-222, and recovery time generally increases with
495 increased concentration (Table A.1.). In addition, trends for decreased survival and higher
496 ETS activity were observed here, albeit non-significant, which may warn against using higher
497 concentration of Eugenol. A pilot study was also done to test for the analgesic properties of
498 hypothermia with ice, as it is commonly used for hemolymph collection for instance. We did
499 not find evidence for an analgesic-like effect of immersion in melted-ice (Appendix C). This
500 result warns against using ice for surgical anesthesia in this temperate species of freshwater
501 amphipod.

502 We further monitored the temporal changes in locomotion and O₂ consumption rate
503 during sedation under MS-222. During the first half, swimming decreased sharply but
504 locomotion was maintained at an intermediate rate corresponding to crawling on the side
505 (pers. obs.) and oxygen consumption rate was comparable to that of controls. After 22 min in
506 MS-222, gammarids switched from intermediate locomotion to inactivity. Oxygen
507 consumption seemed to be retained at low rate until the last minutes of anesthesia. Recovery
508 from sedation followed the opposite pattern, with first a sharp increase in intermediate
509 locomotion at low O₂ consumption rate within the first 11 min, and then progressive increase
510 in swimming and oxygen consumption rate. This sharp decrease in swimming in MS-222 bath
511 and rapid resumption of moderate locomotion upon transfer to water, can be interpreted
512 considering the mode of action of MS-222 at the tissue level (Stanley et al. 2020). The
513 electrical activity in sensory neurons of crayfish abdominal muscle receptor organ and of crab
514 chordotonal organ within the limb, showed a substantial decrease within 15 min incubation in

515 0.1% MS-222 and a gradual return within 20 min washing out (Stanley et al. 2020). The
516 temporal dynamics of induction and recovery observed here at the level of whole-body
517 motion is therefore consistent with these temporal changes in neural activity at the tissue
518 level. This comparison between the organismic and tissue levels only considers motor
519 mechanisms. It is not known whether swimming in these organisms is under motivational
520 processing. Additionally, we did not find evidence for a complete cessation of oxygen
521 consumption under full sedation with MS-222, although the respirometry device used did not
522 allow a quantitative comparison with controls during phases of large differences in motion
523 (last 22 min of anesthesia and first 22 min of recovery). The observed maintenance of O₂
524 consumption at a low rate under sedated state is consistent with the sustained heart rate (but
525 not gill rate) reported in Horseshow crab anesthetized with MS-222 (Archibald et al., 2019).

526 Overall, the temporal changes in locomotion and oxygen consumption during recovery
527 together with the analgesic-like effect of MS-222 during the first 3 min recovery suggest that
528 MS-222 is an efficient way to cope with stressful or harmful manipulations for a few minutes
529 following transfer out of anesthetic bath. Future studies should be run to assess how long the
530 analgesic-like effect lasts beyond these few minutes, given the fast resumption of locomotion
531 at low-intermediate level during the first 11 min of recovery. For experiments requiring
532 longer time under full anesthesia, it could be worth testing longer stay in MS-222 for
533 manipulation, providing that side-effect are addressed concomitantly.

534 We did not find evidence for immediate after-effect of anesthesia on several
535 physiological markers nor on survival at 6 days. In gammarids anesthetized with MS222 or
536 Eugenol, cellular metabolism, non-enzymatic antioxidant capacity and neural homeostasis
537 (approximated by AChE activity) were preserved at levels comparable to unanesthetized
538 gammarids. The maintenance of total antioxidant capacity despite anesthesia with Eugenol is
539 not consistent with a previous study suggesting its pro-oxidant effect in subadults of the white

540 shrimp *Litopenaeus vannamei* (Parodi et al. 2012). However, the induction of oxidative stress
541 might have resulted from the long duration of incubation of white shrimps in eugenol (6 hrs)
542 rather than from the concentration used (5 times lower for individuals at least 10 times bigger,
543 compared to the present study). More generally, both low (residual) oxygen consumption and
544 the short time under full sedation (evidenced in locomotory test with MS-222) may explain
545 the lack of physiological imprint of incubation in MS-222 observed here. No effect on AChE
546 activity was evidenced either, in agreement with the fairly high concentration needed to
547 decrease AChE activity by 50% in the brain of minnow (*Phoxinus phoxinus*) (150 at $1.3 \cdot 10^{-2}$
548 M) compared to other chemicals (Olsen and Christensen, 1980). However, to complete this
549 study, the response of other biomarkers commonly used in ecotoxicological studies should be
550 investigated, such as Glutathione-S-Transferase activity (detoxification) and Heat-Shock-
551 proteins (cellular homeostasis and stress response) (Kunz et al. 2010). In addition, possible
552 long-term sublethal effects or carry-over effects of MS-222 should be investigated, especially
553 if anesthesia must be repeatedly performed on the same individuals.

554

555 Conclusion

556 We provide evidence for the efficiency and safety of MS-222 incubation for anesthesia
557 of *G. pulex*, including analgesic-like effect, contrasting with mixed evidence based on
558 previous studies on crustaceans. Eugenol was as efficient as MS-222 in inducing sedation, but
559 less in inducing analgesia-like effect. The use of Eugenol for full anesthesia should therefore
560 require further investigation with either a longer induction time or higher concentration, at the
561 risk of inducing changes in metabolism, mortality or oxidative stress as reported in previous
562 studies, and suspected here. The comparison to previous studies was limited by (1) the lack of
563 studies on analgesic-like effect; (2) heterogeneity among studies in the optimal concentration
564 and times for sedation. Noticeably, both the efficiency of sedative agent and its consistency

565 vary between species and, within species, with size and temperature, suggesting that species-
566 specific studies comparing different drugs should be performed prior to using any anesthetic
567 procedure (Darbyshire et al. 2019; Table 1). Heterogeneity or lack of consistency across
568 studies could also be due to variable criteria used to determine sedation state based on
569 locomotion pattern and escape response. For instance, it is surprising to find no relationship
570 between induction and recovery time across studies (Table 1: $N = 15$, $Rho=0.06$, $P = 0.82$).
571 We suggest that visual inspection of immobility and lack of reaction to manual stimulus still
572 comes with lack of precision, and automated system to record locomotion and deliver
573 stimulus should therefore be preferred. In addition, they should be used for assessment of
574 sedative effect only, with limited reliability to assess the level of stress or nociception
575 experienced by the animal. For instance, here, induction time of 30 min at $100 \mu\text{L} \cdot \text{L}^{-1}$
576 Eugenol fulfilled sedation criteria, yet it did not prevent gammarids from experiencing
577 nociception. Validation of anesthetic procedure should therefore rely on analgesia/amnesic
578 effects.

579 The properties required for anesthesia vary both in duration and intensity, depending
580 on the objective. Transportation and mildly stressful handling rely on light sedation, while
581 managing stress and nociception associated with intensive and invasive manipulation
582 respectively, requires full anesthesia. Optimal duration also depends on transportation and
583 manipulation constraints and should balance the potential deleterious effect of high
584 concentration for quick induction versus long induction time at low concentration. This study
585 shows that both “Do-it-yourself” engineering and standard paradigm can be used to design
586 standardized and flexible tests. We hope it will stimulate further investigation, not only to
587 optimize sedative-anesthetic procedures for transportation, but also for stressful and invasive
588 manipulation of aquatic invertebrates.

589

590 *Ethics.* The study complies with the rules of ethics as prescribed by the French legislation and
591 the Université de Bourgogne Franche-Comté.

592 *Data accessibility.* Data are available from Mendeley Repository: V1, doi:
593 10.17632/yfsjx8p7vv.1

594 *Authorship statements*

595 Marie-Jeanne Perrot-Minnot: conceptualization, methodology, investigation, formal analysis,
596 visualization, writing original draft. Aude Balourdet: conceptualization, investigation. Olivier
597 Musset: conceptualization, methodology, investigation, visualization, writing original draft.

598 *Competing interests.* We have no competing interests.

599 *Acknowledgements:* We thank Stéphane Pernot and Bernard Sinardet from the electronic
600 workshop of ICB laboratory for their contribution to the design of the electric shock device,
601 and for the PC software, and Bertand Kibler of ICB for access to 3D-printer.

602

603

604 **References**

605 Ahmad, M.F. 1969. Anaesthetic effect of Tricaine Methane Sulfonate (MS 222 Sandoz) in
606 *Gammarus pulex* (L.) (Amphipoda). *Crustaceana*, 16, 197–201.

607 Archibald, K.E., Scott, G.N., Bailey, K.M., Harms, C.A. 2019. 2-phenoxyethanol (2-pe)
608 and tricaine methanesulfonate (ms-222) immersion anesthesia of American
609 horseshoe crabs (*Limulus polyphemus*). *J. Zoo Wildlife Medi.* 50, 96-196. doi:
610 10.1638/2018-0085.

611 Browman, H.J., Cooke, S.J., Cowx, I.G., Derbyshire, S.W.G., Kasumyan, A., Key, B.,
612 Rose, J.D., Schwab, A., Berit Skiftesvik, A., Stevens, E.D., Watson, C.A.,
613 Arlinghaus, R.2019. Welfare of aquatic animals: where things are, where they are
614 going, and what it means for research, aquaculture, recreational angling, and
615 commercial fishing. *ICES J. Mar. Sci.* 76, 82–92. doi.org/10.1093/icesjms/fsy067.

616 Cooper, J.E. 2011. Anesthesia, analgesia, and euthanasia of Invertebrates. *ILAR J.* 52,
617 196-204. doi: 10.1093/ilar.52.2.196.

618 Coyle, S.D., Durborow, R.M., Tidwell, J.H. 2004. Anesthetics in aquaculture. SRAC
619 Publication, No. 3900.

620 Darbyshire, A.K., Oliver, K.H., Dupont, W.D., Plummer, W.D., Jones, C.P., Boyd, K.L.
621 2019. Anesthesia and euthanasia of Brine Shrimp (*Artemia franciscana*). *J. Am.*
622 *Assoc. Lab. Anim. Sci.* 58, 58-64. doi: 10.30802/AALAS-JAALAS-18-000040.

623 Diggles, B.K. 2019. Review of some scientific issues related to crustacean welfare. *J.*
624 *Mar. Sci.* 76, 66–81. doi.org/10.1093/icesjms/fsy058.

625 Dinno, A. 2017. dunn.test: Dunn's Test of Multiple Comparisons Using Rank Sums. R
626 package version 1.3.5. <https://CRAN.R-project.org/package=dunn.test>.

627 Elwood, R.W. 2019. Discrimination between nociceptive reflexes and more complex
628 responses consistent with pain in crustaceans. *Phil. Trans. R. Soc. B* 374,
629 20190368. doi: 10.1098/rstb.2019.0368.

630 Fossat, P., Bacqué-Cazenave, J., De Deurwaerdère, P., Delbecque J.P., Cattaert, D. 2014
631 Anxiety-like behavior in crayfish is controlled by serotonin. *Science* 344, 1293–
632 1297. DOI: 10.1126/science.1248811.

633 Ghanawi, J., Saoud, G., Zakher, C., Monzer, S. and Saoud, I.P. 2019. Clove oil as an
634 anaesthetic for Australian redclaw crayfish *Cherax quadricarinatus*. *Aquacult.*
635 *Res.* 50: 3628-3632. DOI:10.1111/are.14319.

636 Glazier, D.S. 2005. Beyond the '3/4-power law': variation in the intra- and interspecific
637 scaling of metabolic rate in animals. *Biol. Rev. Camb. Phil. Soc.* 80, 611–662. doi:
638 10.1017/S1464793105006834.

639 Goode K., Rey K. 2019. ggResidpanel: Panels and interactive versions of diagnostic plots
640 using 'ggplot2'. R package version 0.3.0. [https://CRAN.R-](https://CRAN.R-project.org/package=ggResidpanel)
641 [project.org/package=ggResidpanel](https://CRAN.R-project.org/package=ggResidpanel).

642 Kelz, M.B., Mashour, G.A. 2019. The biology of general anesthesia from paramecium to
643 primate. *Curr. Biol.* 29, R1199–R1210. doi: 10.1016/j.cub.2019.09.071.

644 Kunz, P.Y., Kienle, C., Gerhardt, A. 2020. *Gammarus spp.* in aquatic ecotoxicology and
645 water quality assessment: toward integrated multilevel tests. *Rev. Environ.*
646 *Contam. Toxicol.* 205,1-76. doi: 10.1007/978-1-4419-5623-1_1.

647 Li, Y., She, Q., Han, Z., Sun, N., Liu, X., Li, X. 2018. Anaesthetic effects of Eugenol on
648 grass shrimp (*Palaemonetes sinensis*) of different sizes at different concentrations
649 and temperatures. Sci. Rep. 8, 11007. doi.org/10.1038/s41598-018-28975-w.

650 Morgan, J., Cargill, C., Groot, E. 2001. The efficacy of clove oil as an anesthetic for
651 decapod crustaceans. Bull. Aquacul. Assoc. Canada 101, 27-31. doi:
652 10.1089/154585404774101671.

653 Olsen, D.L., Christensen, G.M. 1980. Effects of water pollutants and other chemicals on
654 fish Acetylcholinesterase (in vitro). Environ. Res. 21, 327-335. doi: 10.1016/0013-
655 9351(80)90034-1.

656 Parodi, T.V., Cunha, M.A., Heldwein, C.G., de Souza, D.M., Martins, Á.C., Garcia, L.O.,
657 Wasielesky, W.Jr, Monserrat, J.M., Schmidt, D., Caron, B.O., Heinzmann, B.,
658 Baldisserotto, B. 2012. The anesthetic efficacy of eugenol and the essential oils of
659 *Lippia alba* and *Aloysia triphylla* in post-larvae and sub-adults of *Litopenaeus*
660 *vannamei* (Crustacea, Penaeidae). Comp. Biochem. Physiol. C 155, 462–468. doi:
661 10.1016/j.cbpc.2011.12.003.

662 Perrot-Minnot, M.-J, Sanchez-Thirion, K., Cézilly, F. 2014. Multidimensionality in host
663 manipulation mimicked by serotonin injection. Proc. R. Soc. Lond. B, 20141915.
664 doi: 10.1098/rspb.2014.1915.

665 Perrot-Minnot, M.-J., Banchetry, L., Cézilly, F. 2017. Anxiety-like behavior increases
666 safety from fish predation in an amphipod crustacea. R. Soc. Open Sci., 4, 171558.
667 DOI:10.1098/rsos.171558.

668 Pohlert, T. 2014. _The pairwise multiple comparison of mean ranks package (PMCMR).
669 R package, <https://CRAN.R-project.org/package=PMCMR>.

670 Ramlochansingh, C., Branoner, F., Chagnaud, B.P., Straka, H. 2014. Efficacy of tricaine
671 methanesulfonate (MS-222) as an anesthetic agent for blocking sensory-motor
672 responses in *Xenopus laevis* tadpoles. PLoS ONE, 9, e101606. doi:
673 10.1371/journal.pone.0101606.

674 Romano, J., Kromrey, J.D., Coraggio, J., Skowronek, J., Devine, L. 2006. Exploring
675 methods for evaluating group differences on the NSSE and other surveys: are the t-
676 test and Cohen's d indices the most appropriate choices? In Annual meeting of the
677 Southern Association of Institutional Research, 14–17 October 2006, Arlington,
678 VA, USA.

679 Rosner, A., Armengaud, J., Ballarin, L., Barnay-Verdier, S., Cima, F., Coelho, A.V.,
680 Domart-Coulon, I., Drobne, D., Genevière, A.M., Jemec Kokalj, A., Kotlarska, E.,
681 Lyons, D.M., Mass, T., Paz, G., Pazdro, K., Perić, L., Ramšak, A., Rakers, S.,
682 Rinkevich, B., Spagnuolo, A., Sugni, M., Cambier, S.. 2021. Stem cells of aquatic
683 invertebrates as an advanced tool for assessing ecotoxicological impacts. Sci Total
684 Environ., 771, 144565. doi: 10.1016/j.scitotenv.2020.144565.

685 RStudio Team 2020. RStudio: Integrated Development Environment for R. RStudio, PBC,
686 Boston, MA URL <http://www.rstudio.com/>, Austria. URL [https://www.R-
687 project.org/](https://www.R-project.org/).

688 Saydmohammed, M., Pal, A.K., 2009. Anesthetic effect of eugenol and menthol on
689 handling stress in *Macrobrachium rosenbergii*. Aquacult. 298, 162–167. doi:
690 10.1038/s41598-018-28975-w.

691 Sneddon L.U., Elwood, R.W., Adamo, S.A., Leach, M.C. 2014. Defining and assessing
692 animal pain. An. Behav. 97, 201-212. doi.org/10.1016/j.anbehav.2014.09.007.

693 Soulsbury, C.D., Gray, H.E., Smith, L.M., Braithwaite, V., Cotter, S.C., Elwood, R.W.,
694 Wilkinson, A., Collins, L.M. 2020. The welfare and ethics of research involving
695 wild animals. *Methods Ecol Evol.* 11, 1164–1181. doi.org/10.1111/2041-
696 210X.13435.

697 Stanley, C.E., Adams, R., Nadolski, J., Amrit, E., Barrett, M., Bohnett, C., Campbell, K.,
698 Deweese, K., Dhar, S., Gillis, B., Hill, C., Inks, M., Kozak, K., Larson, A.,
699 Murtaza, I., 2020. The effects of tricaine mesylate on arthropods: crayfish, crab
700 and *Drosophila*. *Invert. Neurosc.* 20:10. doi.org/10.1007/s10158-020-00243-5

701 Teles, M., Oliveira, M., Jerez-Cepa, I., Franco-Martínez, L., Tvariionaviciute, A., Tort, L.,
702 Mancera, J.M. 2019. Transport and recovery of gilthead sea bream (*Sparus aurata*
703 *L.*) sedated with clove oil and MS-222: effects on oxidative stress status. *Front.*
704 *Physiol.* 10, 523. doi: 10.3389/fphys.2019.00523.

705 Venarsky, M.P. and Wilhelm, F.M. 2006. Use of clove oil to anaesthetize freshwater
706 amphipods. *Hydrobiol.* 568, 425-432. doi.org/10.1007/s10750-006-0225-

707 Walters, E.T., Williams, A.C. 2019. Evolution of mechanisms and behavior important for
708 pain. *Phil. Trans. R. Soc. B* 374, 20190275. doi: 10.1098/rstb.2019.0275.

709

710 **Figure legends**

711 Fig. 1. Electric shock device: the ES-chamber is made of a 3D block holding two flat
712 electrodes, as seen from the bottom view (a), in which four wires are embedded on each
713 side, delivering electric current to electrodes via two plugs connected to electric power
714 supply, as seen from the top view (b). Total dimensions of ES-chamber:
715 $L \times W \times H = 95 \times 70 \times 40$ mm³ for a swimming volume of dimensions $L \times W \times H = 50 \times 50 \times 27$
716 mm³. The ES-chamber can be easily placed in and removed out of the arena used to score
717 refuge use, as pictured in (c): full setting to expose gammarid to ES and subsequently
718 score refuge use after removing ES-chamber and following recovery (refuge is made of
719 half a terracotta sauce with three entries, one in the front, and one on each side).

720
721 Fig. 2. Measurement of the electrical characteristics of tap water according to distance
722 between electrodes for three voltages (ΔV) (a) current I in mA, (b) resistance R (Ohms).
723 The vertical line corresponds to the actual distance between the electrodes in the device (5
724 cm).

725
726 Figure 3. Measurement of the voltage difference between the mass and a point in the
727 swimming volume (a), and the calculation of corresponding electric field E (b), with a
728 voltage applied between electrodes of 10V. The small voltage drop (0.5V at $Y=0$) giving a
729 full voltage less than the programmed 10V is induced by a current limiting and
730 measurement resistor placed in series in the circuit. The electric field is indeed almost
731 constant over the swimming area, both between electrodes (Y axis) and along each
732 electrode (X axis), with a value of about 1.8V/cm (b).

733

734 Fig. 4. Simplified block diagram of the control electronics with 12 output channels (3*4)
735 (a) (AB - Arduino Board, AS - Arduino Screen), VC - Voltage conditioners, RB - Relay
736 Boards, USB - I/O to PC controller, OC - Output Connector, and view of the PC user
737 interface (b).

738

739 Fig. 5. Dose-effect of MS-222 in *G. pulex* males on the time for induction of sedation (a)
740 and for recovery from sedation (b). Gammarids were immersed individually in MS-222
741 bath to monitor induction time, and in water to monitor recovery time. Full sedation was
742 determined from the lack of pleopod beating and escape reaction to a tactile stimulus, and
743 recovery from resuming escape reaction to the same stimulus. Sample size is 20
744 individuals per concentration.

745

746 Fig. 6. Resumption of locomotor activity of *G. pulex* males following anesthesia in MS-
747 222 at 600 mg.L^{-1} for 45 min, and 50 min recovery in water: proportion of time spent
748 immobile (Immob.: $<7 \text{ mm.s}^{-1}$), at intermediate velocity (Interm.: $7\text{-}15 \text{ mm.s}^{-1}$) or
749 swimming (Swim.: $> 15\text{mm.s}^{-1}$) by gammarids during 15 min recording period. Sample
750 size is 24 for anesthetized group, 36 for controls.

751

752 Fig. 7. Refuge use of gammarids following exposure to noxious stimulus (electric shock:
753 E.S.) or not (Cont. E) under anesthesia or not (Cont. A). Anesthesia was done by
754 immersion in (a) MS-222 for 45 min (600 mg. L^{-1}), (b) Eugenol for 30 min induction
755 (Eug.30) and 45 min. induction (Eug.45) (both at $100 \mu\text{L. L}^{-1}$). The refuge use of
756 individual gammarids was recorded after 50 min (MS-222 and Eug. 30) or 70 min (Eug.
757 45) of recovery in water following anesthesia and exposure to ES. The score of refuge use
758 is the number of times individual gammarids were under refuge out of the maximum score

759 (20) during a 10 min time sampling period and is therefore reported as a frequency.
760 Sample size is given below bars.

761

762 Fig. 8. Effect size of noxious stimulus on refuge use by *G. pulex*, according to the
763 anesthetic treatment prior to delivering electric shocks (ES): MS-222 at 600 mg. L⁻¹ (45
764 min. induction time), Eugenol at 100 mL.L-1 (30 min or 45 min induction time, 50 or 70
765 min recovery time, respectively) and two controls (exposed to ES without anesthesia).
766 Effect size was estimated using Cliff Delta index (and 95% CI): the closer it is to zero, the
767 weaker is the change in refuge use 50 min (MS-222; Eugenol 30-50; Control 50) to 70
768 min (Eugenol 45-70; Control 70) after exposure to electric shocks. Following Romano et
769 al. (2006), the magnitude of effect size can be considered as negligible (less than 0.147),
770 small (between 0.147 and 0.33), medium (between 0.33 and 0.474), or strong (higher than
771 0.474) (dashed vertical lines).

772

773 Fig. 9. Monitoring of changes in locomotor activity of individual gammarids during
774 anesthesia by immersion in MS-222 at 600 mg. L⁻¹ (b, e) and during recovery in water
775 following 45 min immersion in anesthetic bath (c, f) compared to controls. The proportion
776 of time spent at different speed levels (immobile: < 7 mm.s⁻¹ (a, b, c); intermediate level: 7
777 to 15 mm. s⁻¹ (d, e, f); swimming: > 15 mm. s⁻¹ (g, h, i)) was recorded during four
778 consecutive bins of 11 min each. Sample size is 36 for anesthesia, and 36 for recovery.
779 Controls (a, d) placed in water were handled either as gammarids in MS-222 (N = 24) or
780 as gammarids recovering (N = 12). Groups with different letters above bars are
781 significantly different at $P = 0.05$, after Friedman test and a posteriori multiple pairwise
782 comparisons (at immobility and swimming activity only).

783

784 Fig.10. Oxygen consumption rate of *G. pulex* during incubation in MS-222 at 600 mg. L⁻¹
785 (N=63) (a to d), and during the first 33 min recovery in water (e to g), compared with *G.*
786 *pulex* in control water (N=26). Oxygen consumption rate was estimated as the regression
787 slope of O₂ consumption (difference in [O₂] in each well compared to blank well without
788 gammarid multiplied by well volume), on time in min. The 45 min continuous recording
789 of individual gammarids (during anesthetic bath) and 30 min recording during recovery in
790 CW, was split in four bins of 11 min for illustration and analysis.

791

792 Figure 1

793 (1.5 column)

794

795 (a)

(b)

(c)

796

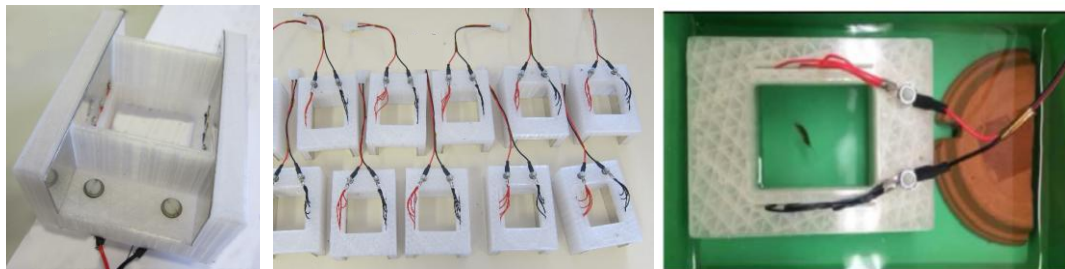

797 Figure 2
 798 (single column)

799
 800 (a)

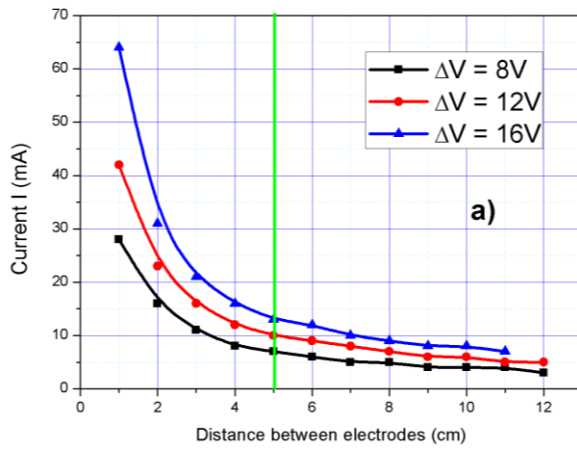

807 (b)

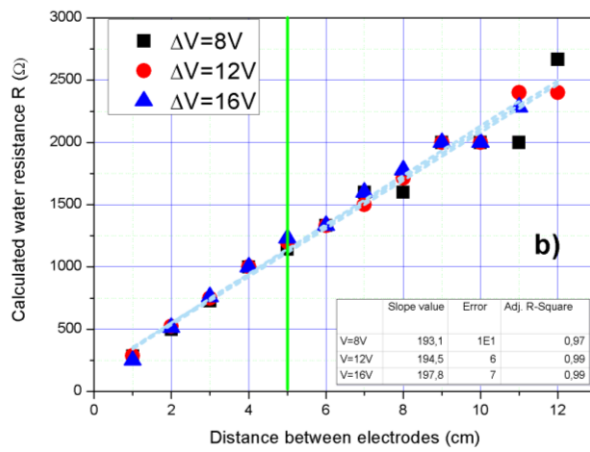

810 Figure 3
811 (single column)

812

813 (a)

814

815

816

817

818

819

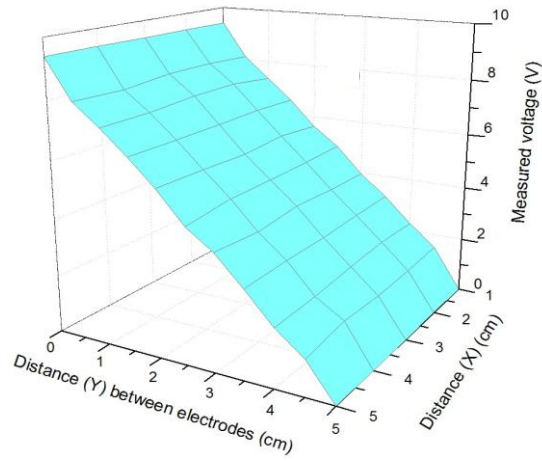

820

(b)

821

822

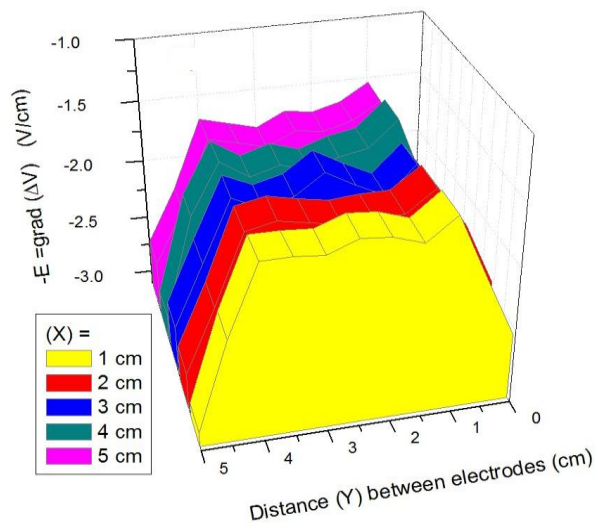

823 Figure 4
824 (single column)

825

826 (a)

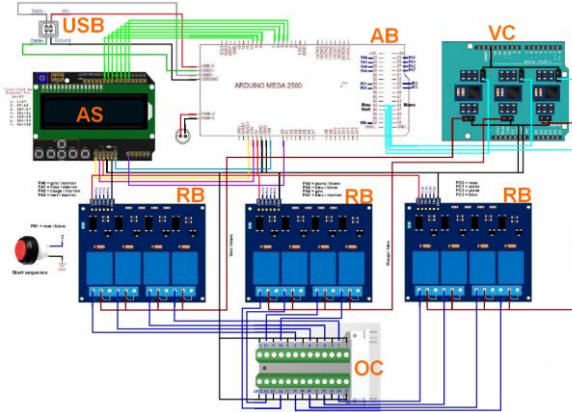

827

828

829

830

831

832 (b)

833

834

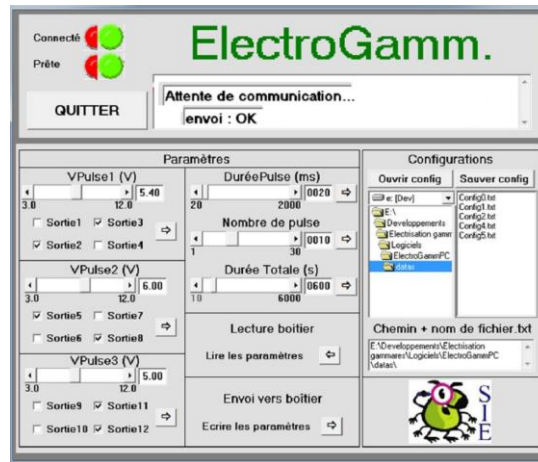

835 Figure 5
836 (single column)

837

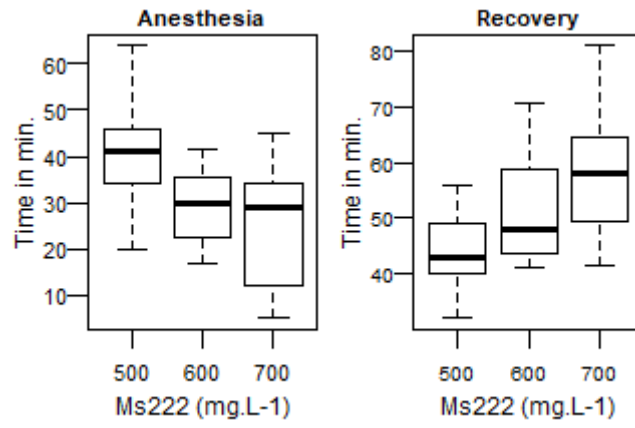

838

839

840 Figure 6
841 (single column)

842

843

844

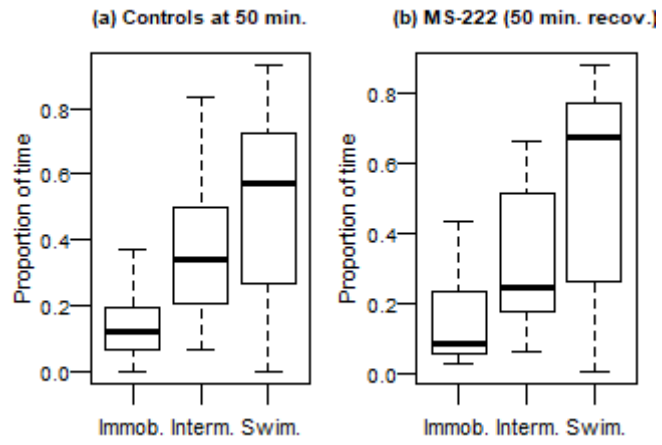

845

846

847 Figure 7
848 (1.5 column)
849

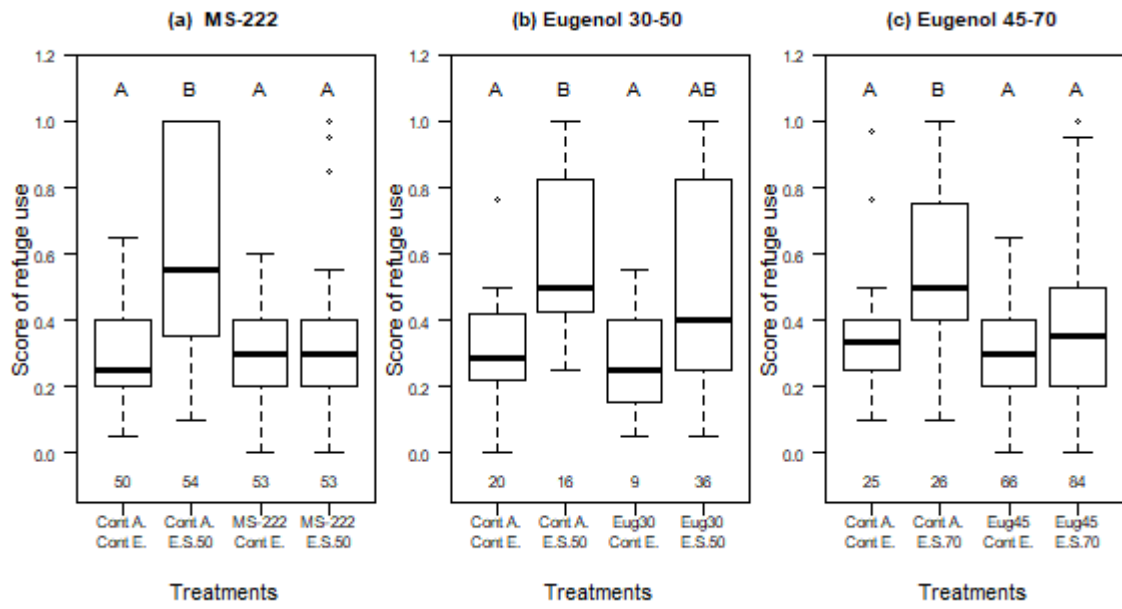

850
851

852 Figure 8
853 (single column)
854

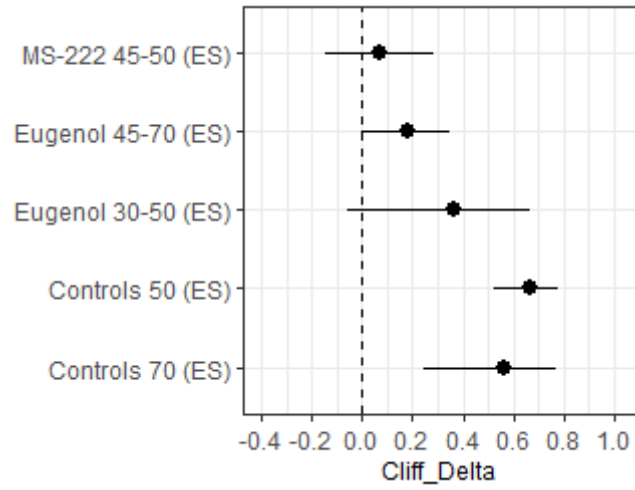

855
856

857 Figure 9
858 (2 columns)

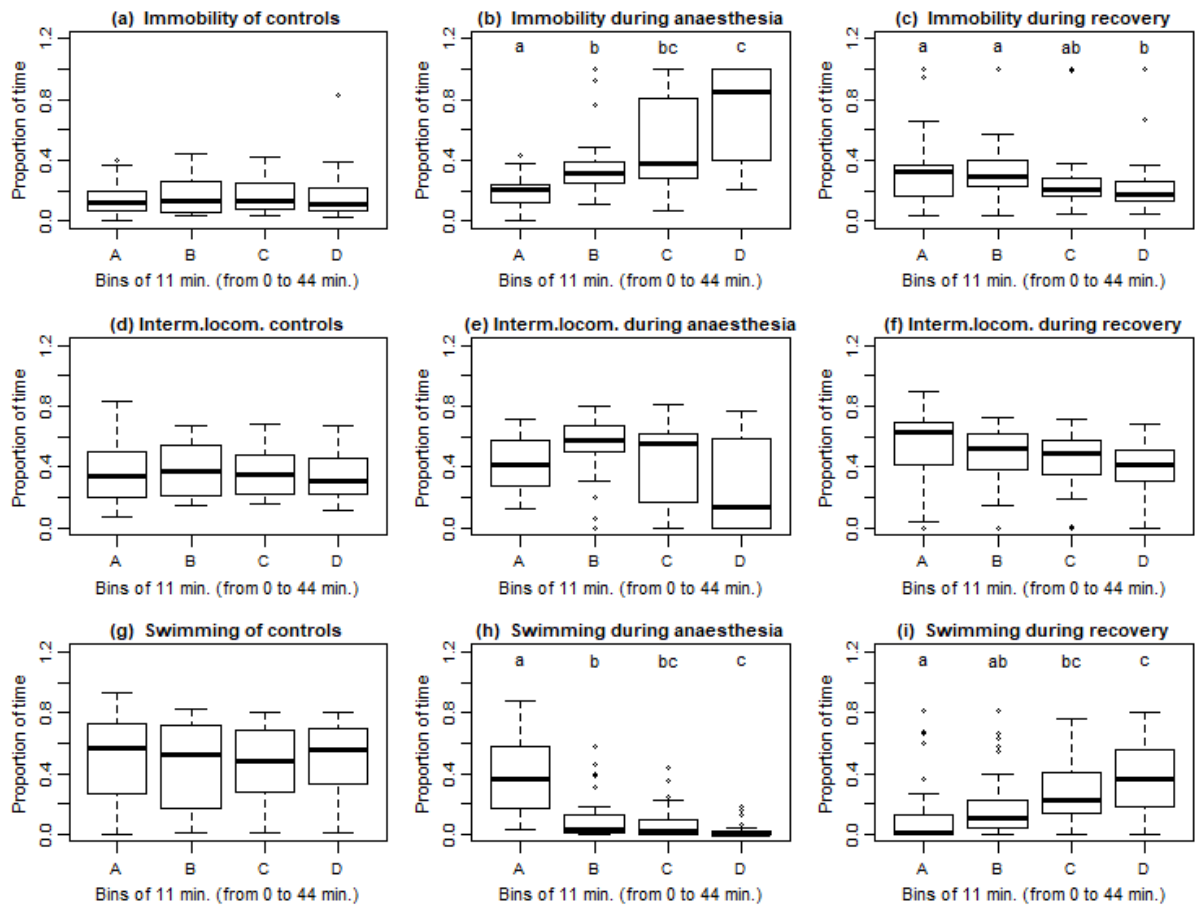

859
860
861

862 Figure 10
863 (1.5 column)
864

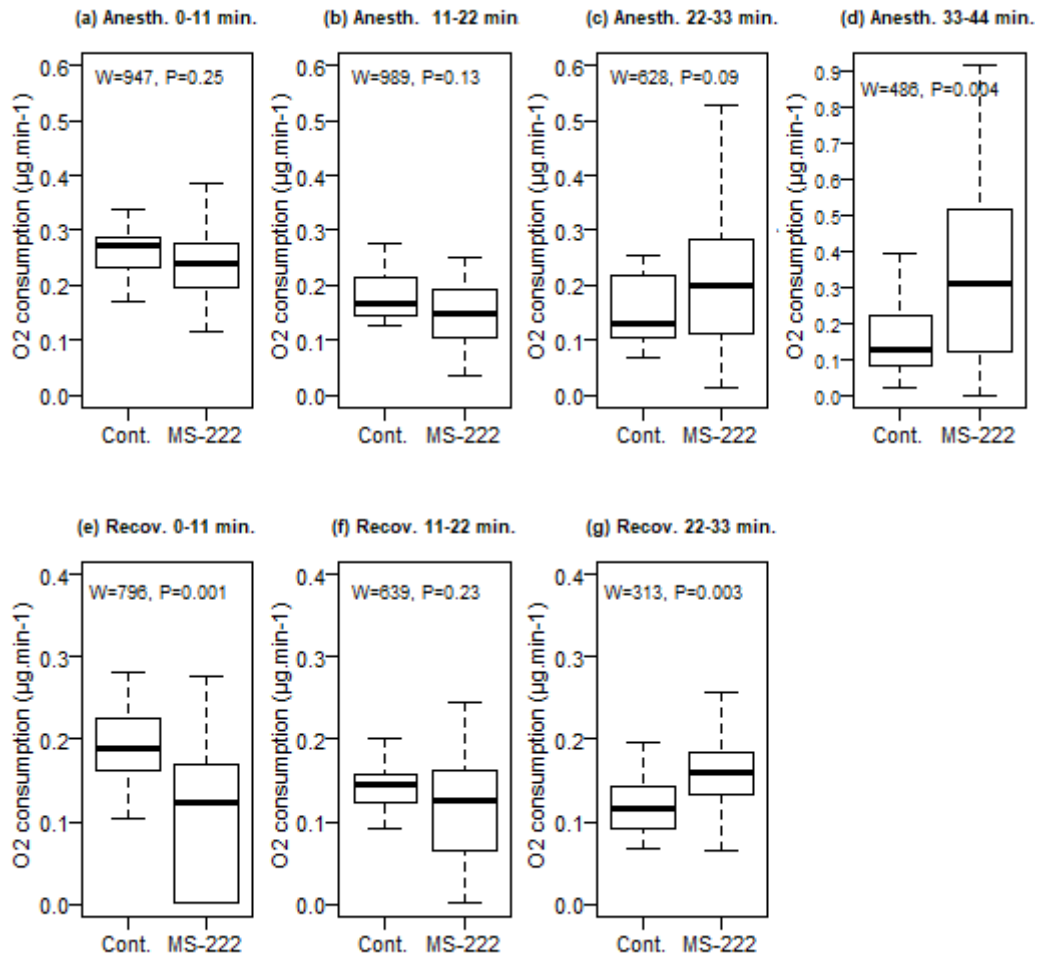

865