



**HAL**  
open science

## Parasitic capacitances in DBD transformerless power supply: an issue?

Mame Andallah Diop, Antoine Belinger, Jean-Marc M Blaquiere, Hubert Piquet

### ► To cite this version:

Mame Andallah Diop, Antoine Belinger, Jean-Marc M Blaquiere, Hubert Piquet. Parasitic capacitances in DBD transformerless power supply: an issue?. High-Tech Plasma Processes Conference (HTPP), Jul 2016, Munchen, Germany. , 2016. hal-03407106

**HAL Id: hal-03407106**

**<https://hal.science/hal-03407106>**

Submitted on 2 Nov 2021

**HAL** is a multi-disciplinary open access archive for the deposit and dissemination of scientific research documents, whether they are published or not. The documents may come from teaching and research institutions in France or abroad, or from public or private research centers.

L'archive ouverte pluridisciplinaire **HAL**, est destinée au dépôt et à la diffusion de documents scientifiques de niveau recherche, publiés ou non, émanant des établissements d'enseignement et de recherche français ou étrangers, des laboratoires publics ou privés.

# Parasitic Capacitances in transformerless power supply for DBD

M.A. Diop, **A. Belinger\***, J.-M. Blaquière, H. Piquet

belinger@laplace.univ-tlse.fr

LAPLACE, Université de Toulouse, CNRS, INPT, UPS, France

2 rue Camichel, 31071 TOULOUSE cedex 7, FRANCE.



## Context and experimental setup

### Traditional High voltage power supply for DBD :

- Voltage applied to obtain breakdown > 4 kV
- Traditional semiconductors sustain 1.7 kV max

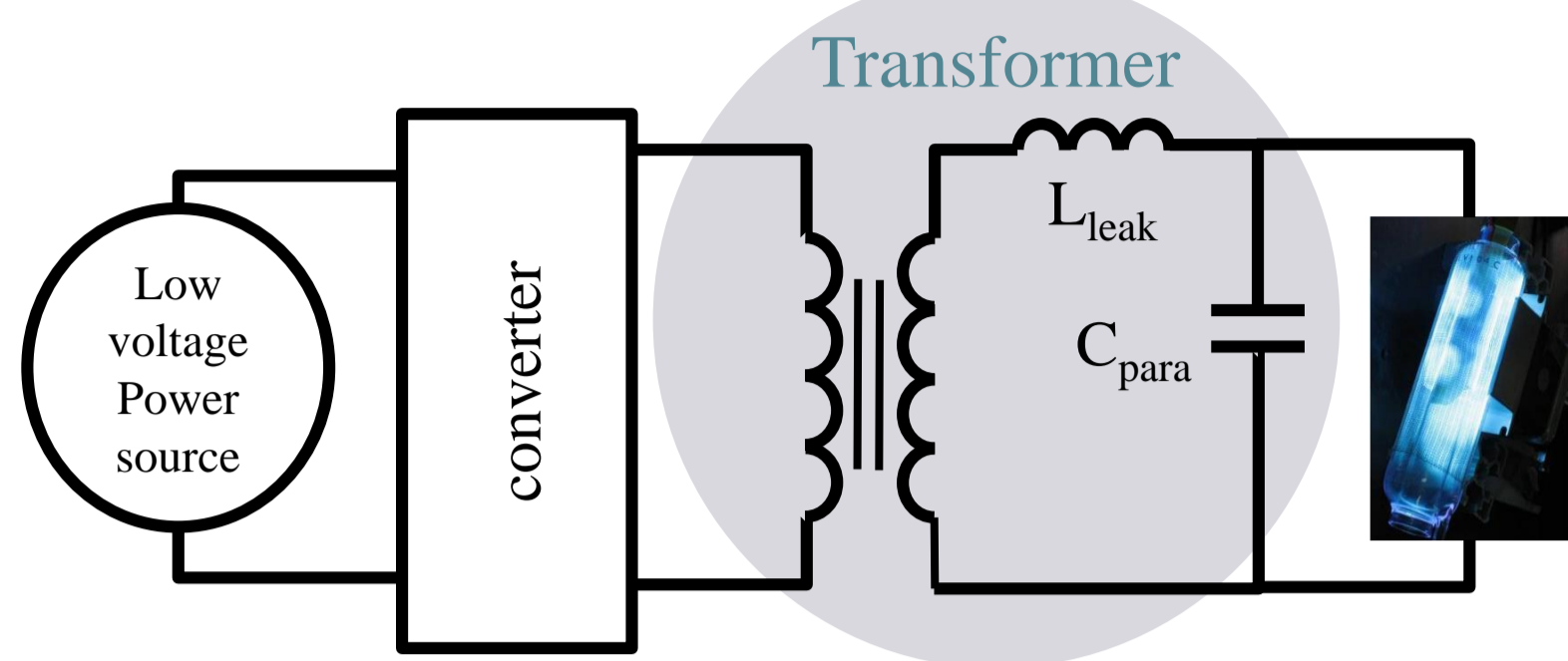

### Or resonance power supply

- No transformer
- Fixed frequency

### Transformer:

- ⊗ Amplifies the voltage → low voltage switch
  - ⊗ Parasitic elements ( $L_{leak}$  and  $C_{para}$ )
    - ⊗ Overlap of converter's switches ( $L_{leak}$ )
    - ⊗ Current leak in parallel  $C_{para}$  capacitance
- Discharge duration and transferred power ↘

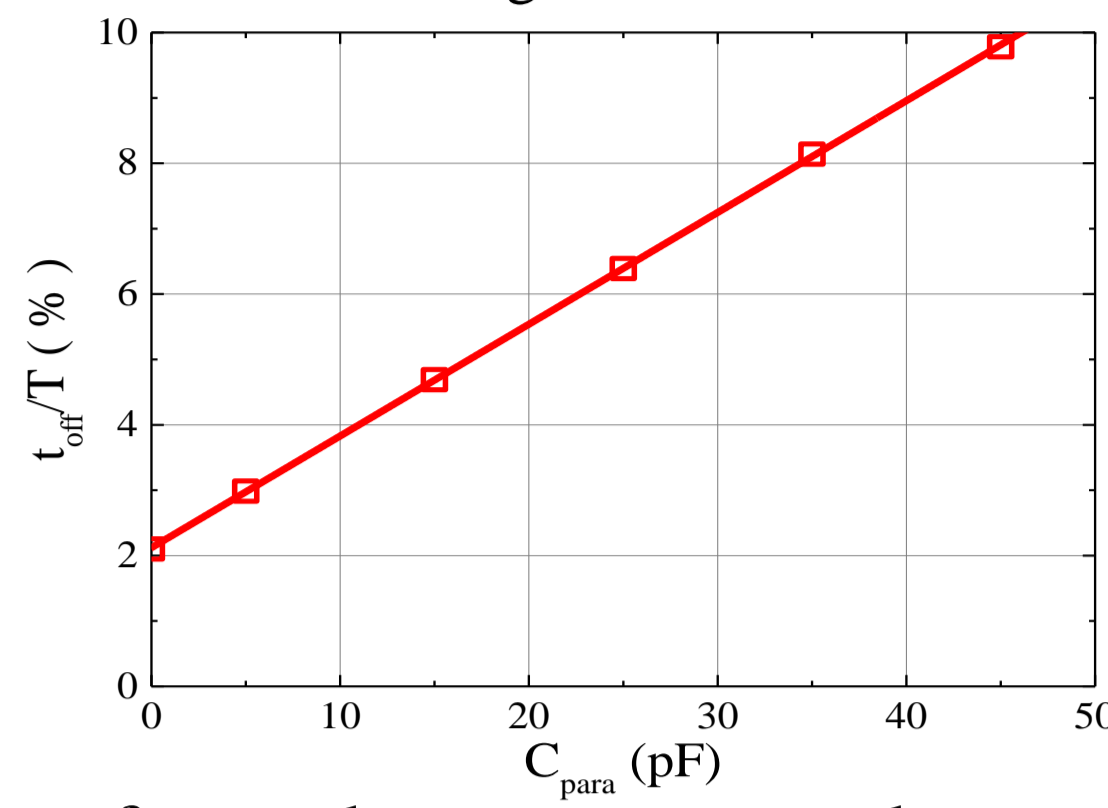

- Transformerless power supply
- Test NEW High Voltage SIC MOSFET > 10 kV

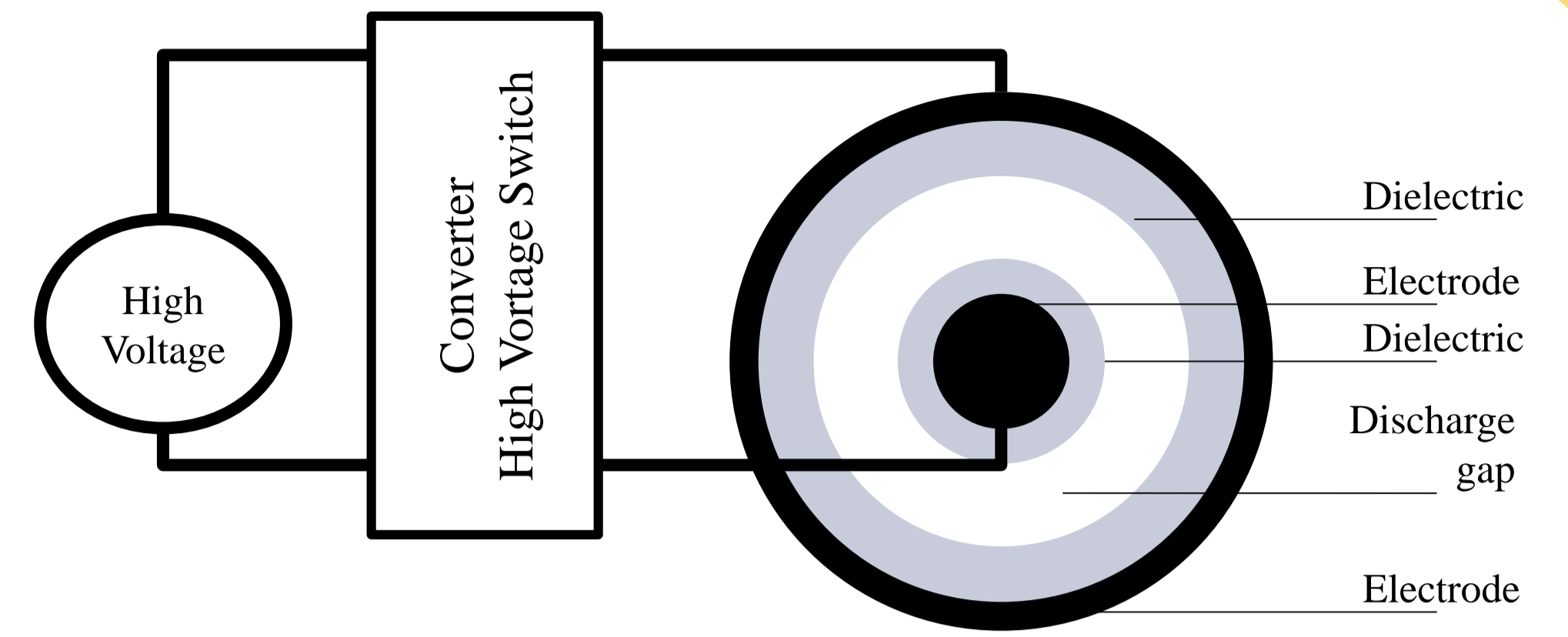

### DBD lamp:

- Length : 115 mm
- Gap : 20 mm -Xe-Cl - Pressure : 120 mBar
- $P_{nom}=100$  W
- Breakdown voltage  $\approx 1,5$  kV
- $C_{gas}=28$  pF -  $C_{diel}=85$  pF

## Power supply : Operating Principle

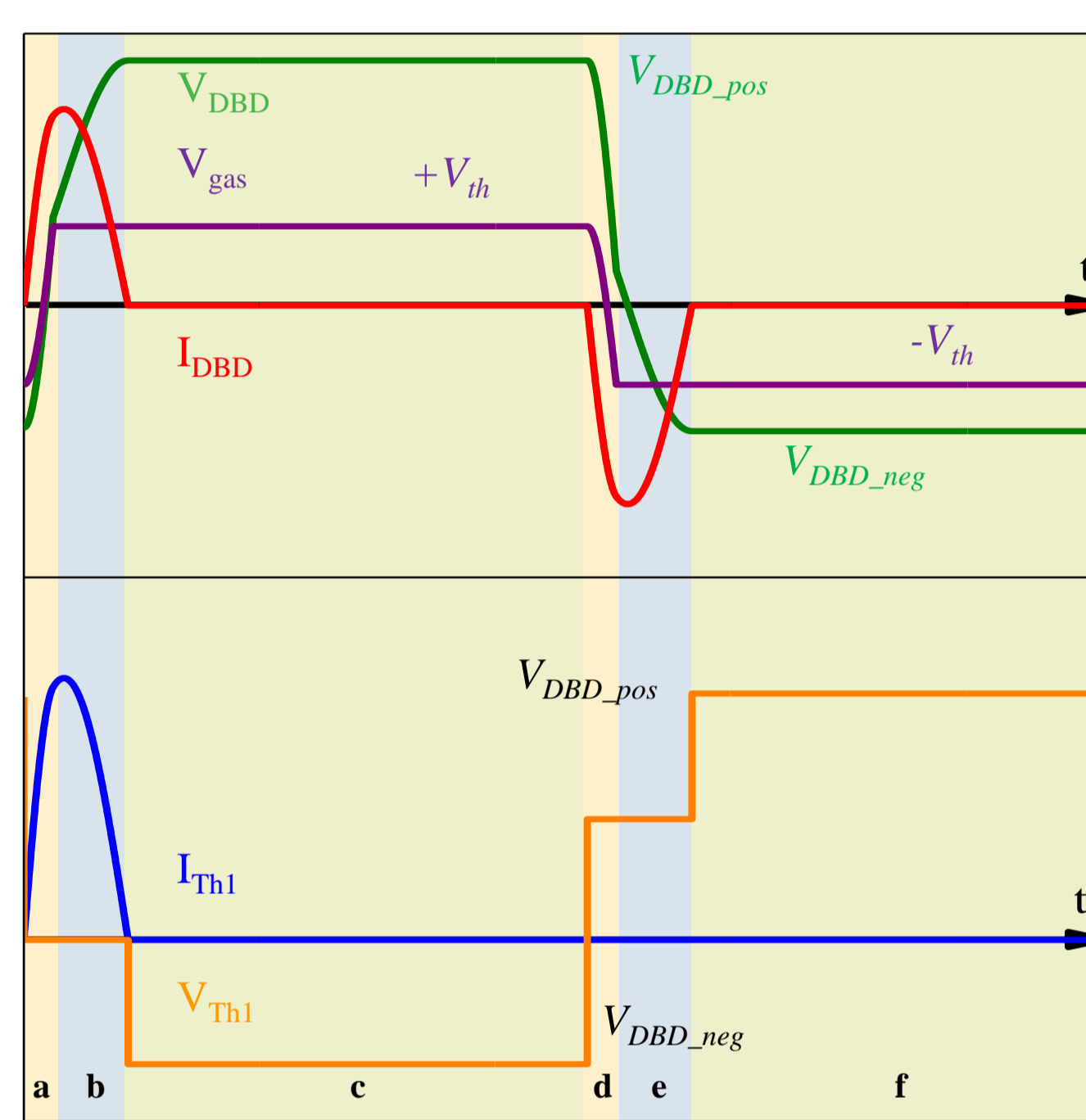
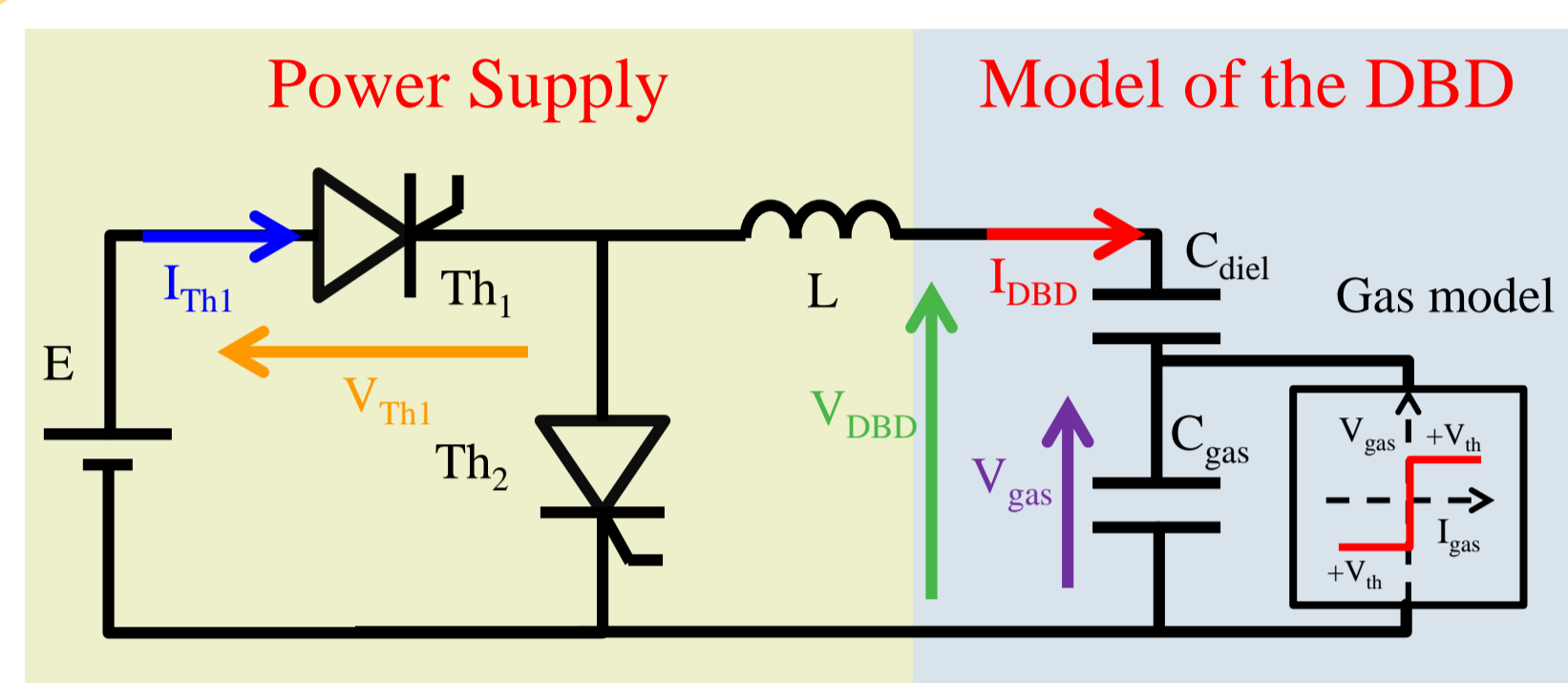

- Use just 2 High Voltage Thyristors
- Second half period: Electrical charges stocked on the dielectric are used to re-ignite the discharge

## High Voltage Switch

- Frequency up to 100 kHz
- Synthesized thyristor
- MOSFET sustains:  $V_{DBD\_pos} \approx$  several kV
- DIODE sustains:  $V_{DBD\_neg} < 1.5$  kV

- "Low" voltage DIODE
- MOSFET:

- High voltage SIC MOSFET

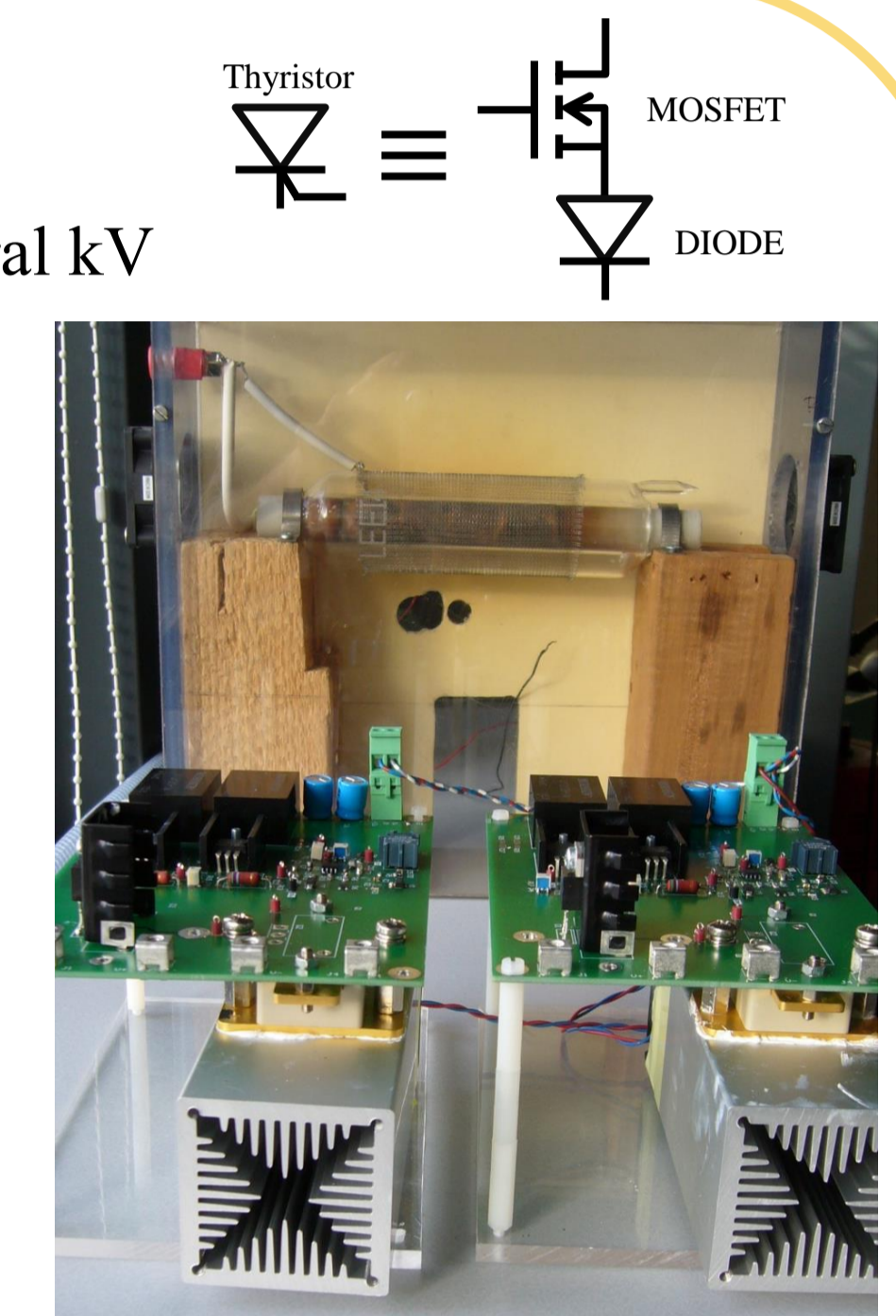

- "Low" voltage switches in series

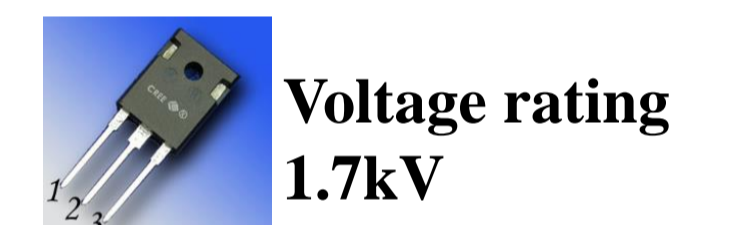
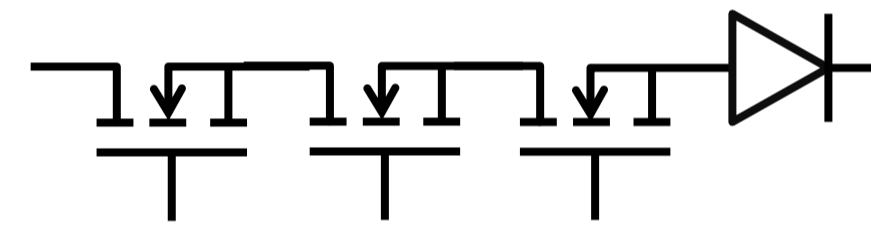

## 10 kV SIC experimental Validation

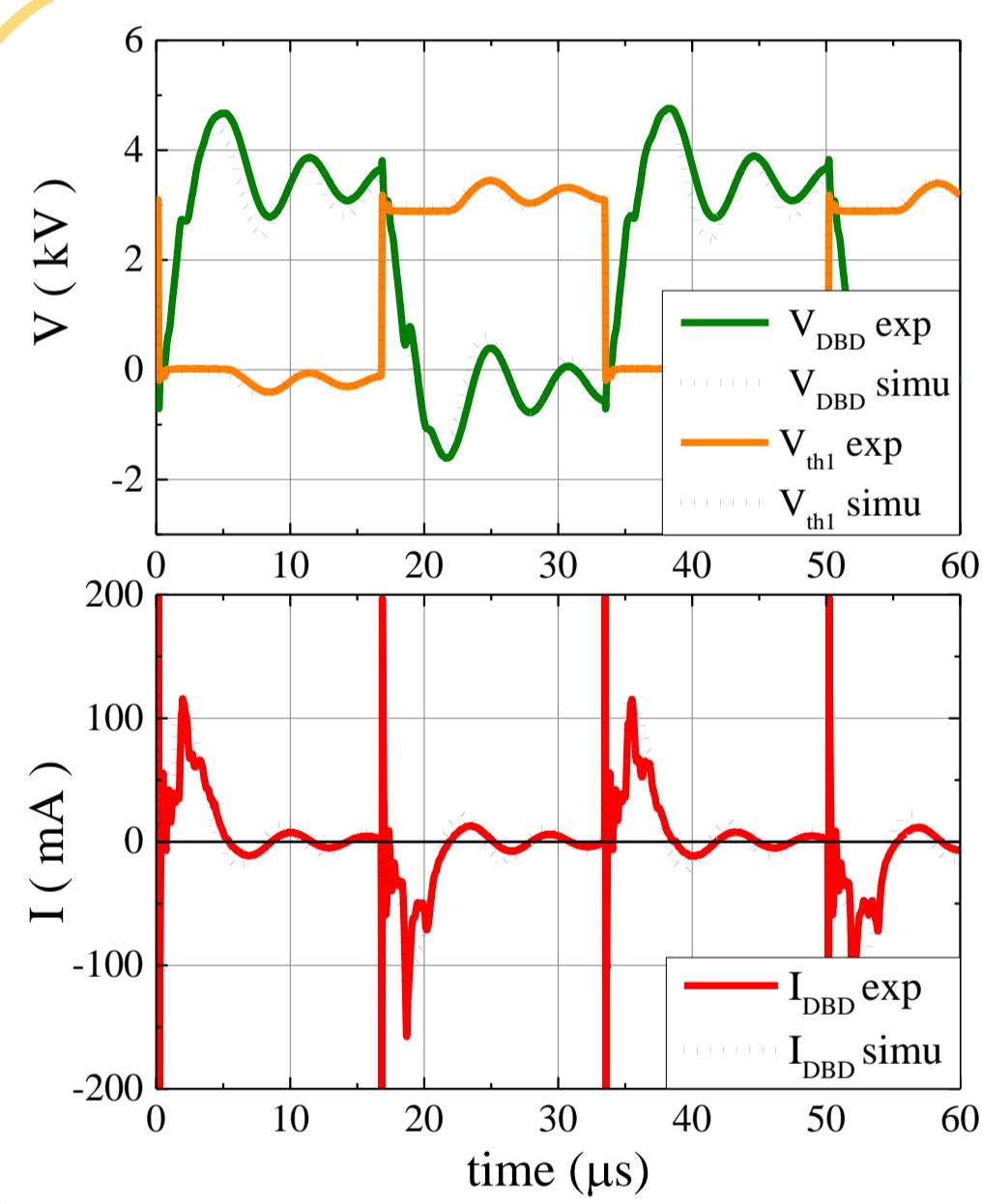

- DBD ignition with control of pulses energy
- Oscillations
- Parasitic capacitances

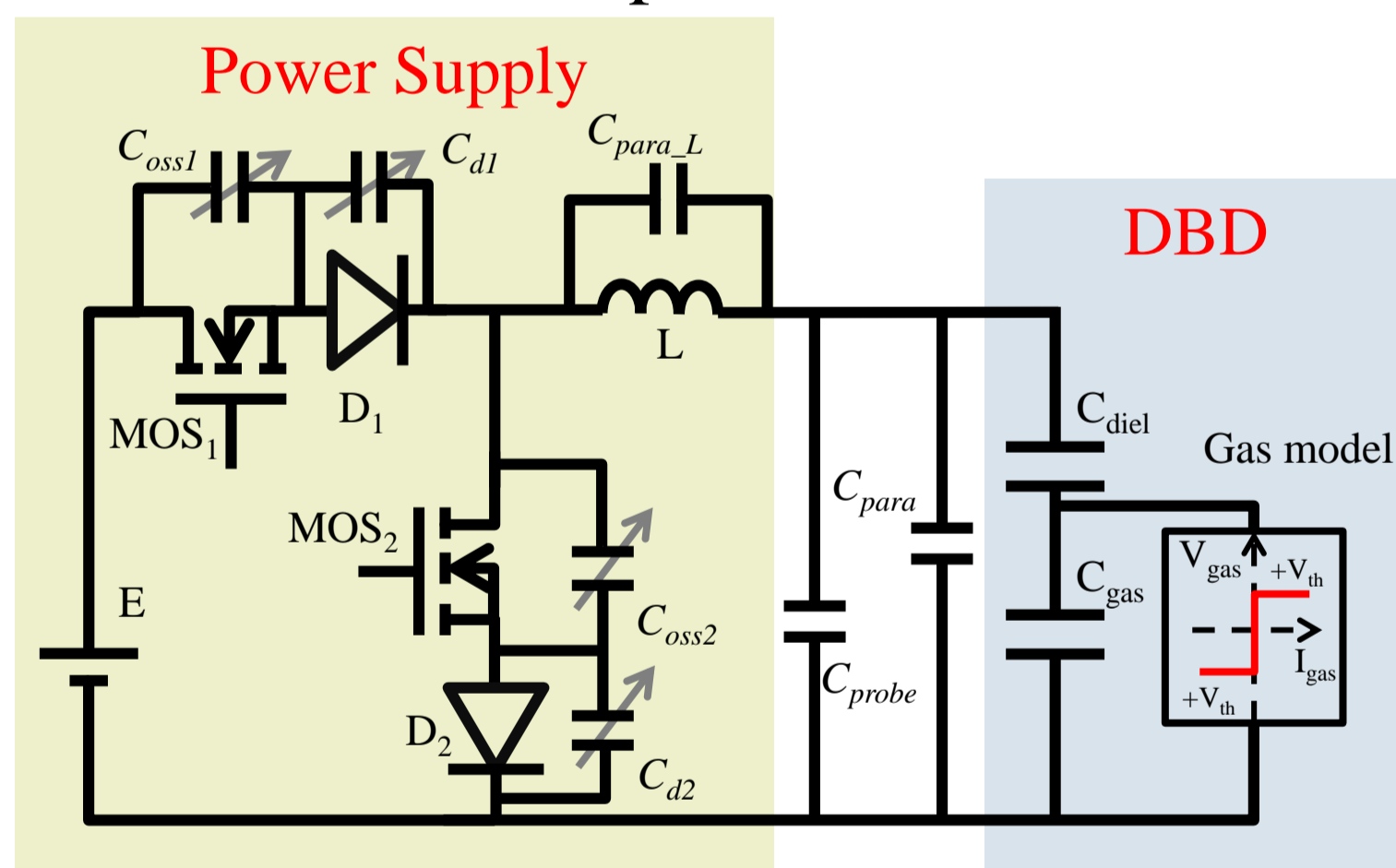

## Parasitic capacitance of the MOSFETS

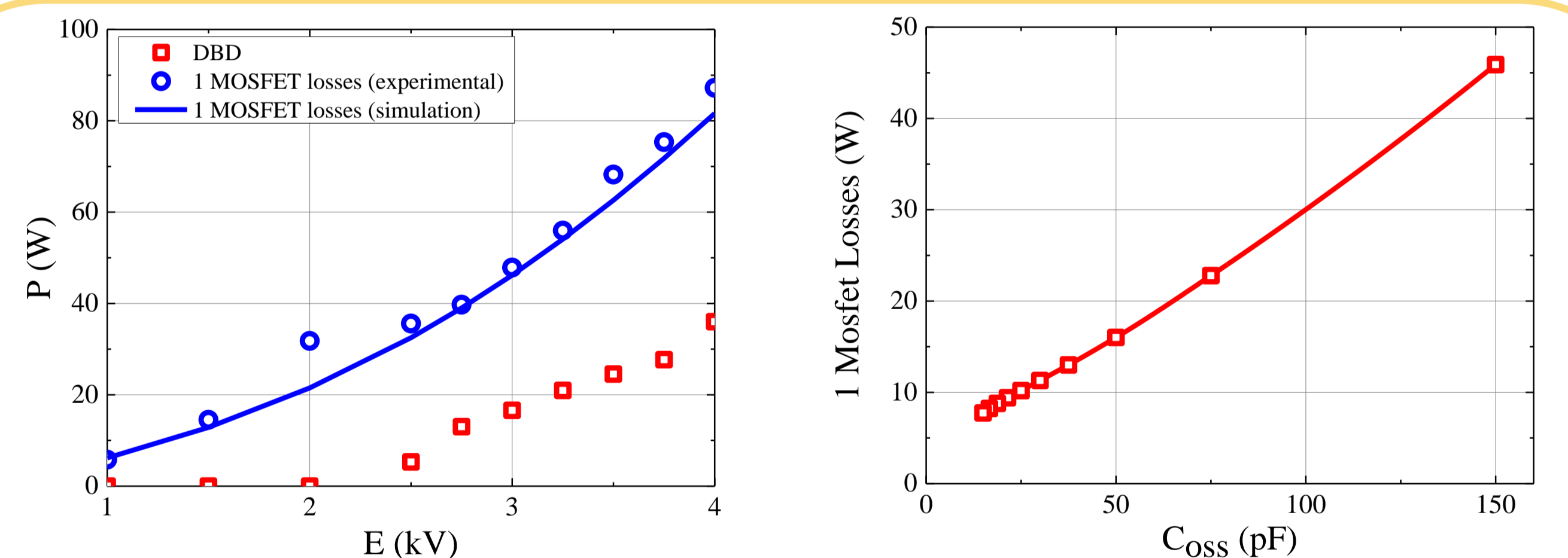

- Intrinsic parasitic capacitance  $C_{oss}$  of the MOSFET sustain  $V_{DBD\_pos}$
- MOSFET turn-ON →  $E_{C_{oss}} = \frac{1}{2} \cdot C_{oss} \cdot V_{DBD\_pos}^2$  dissipated in the MOSFET
- USE LOW  $C_{oss}$  MOSFET in series.

## Parasitic capacitance and MOSFETS in series

- Isolated boards for the control of each MOSFET
- Parasitic capacitance  $C_p$  between these boards and the ground : 0 to 10 pF

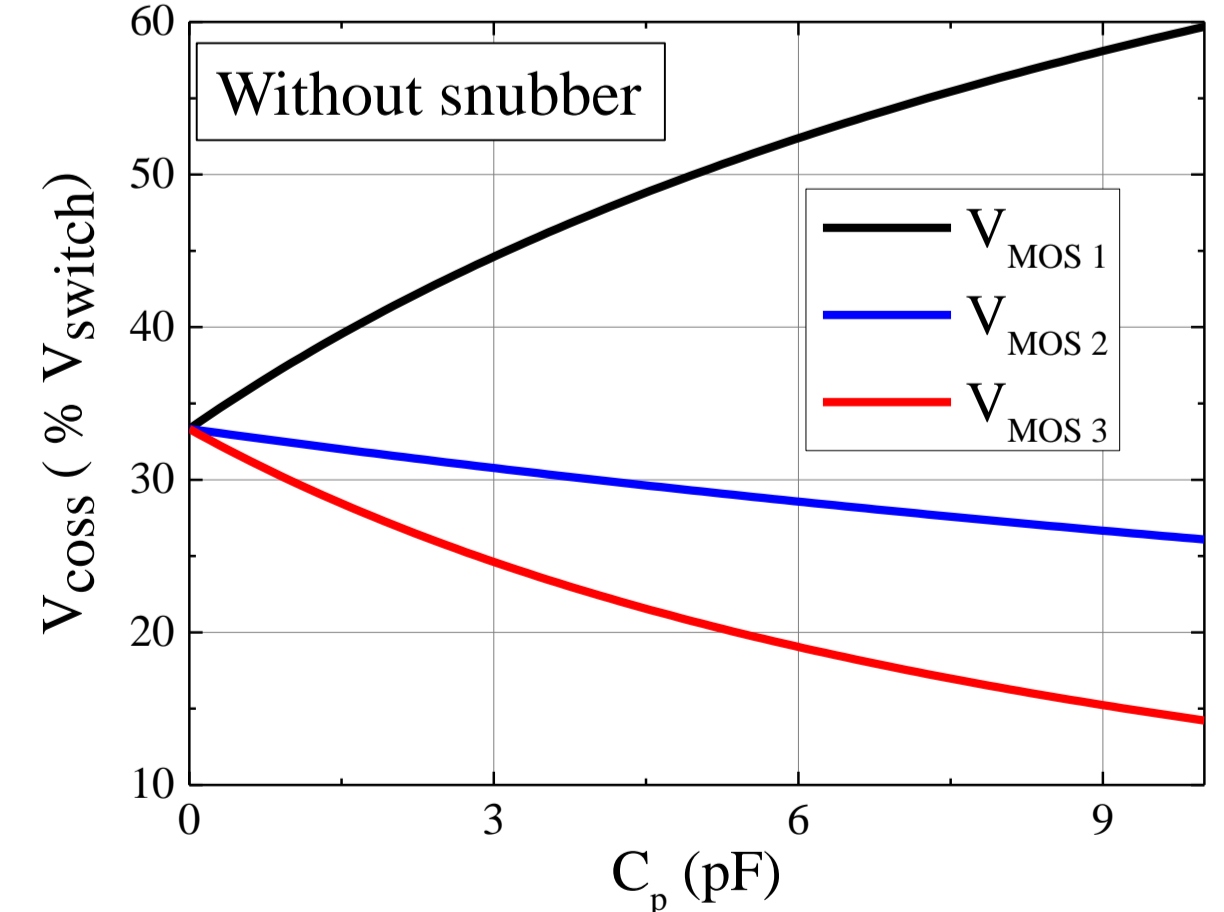
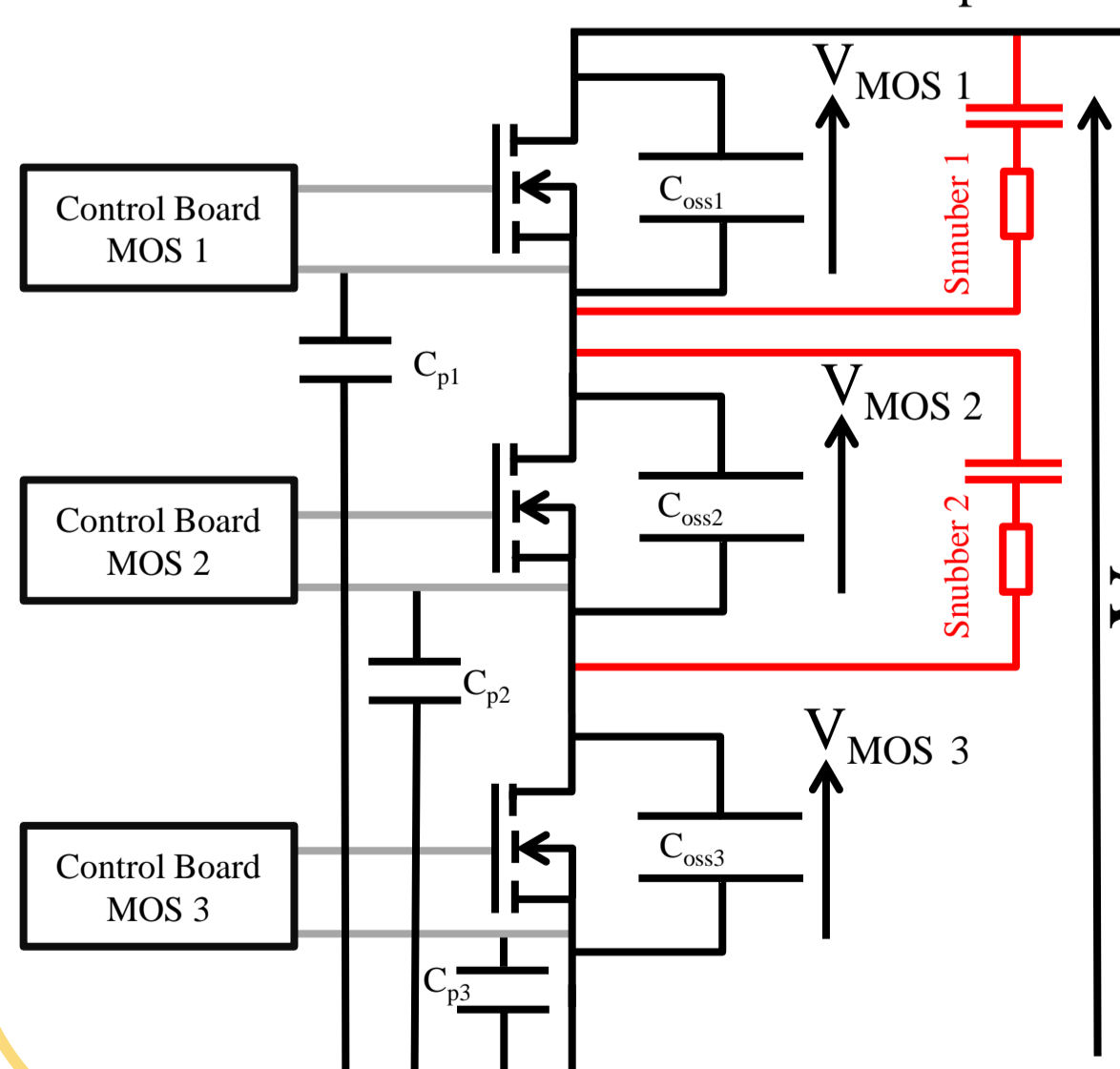

If all  $C_{oss}$  are equal, each MOSFET show different voltages → SNUBBER (RC circuit) balances the MOSFETS voltages → Losses in the SNUBBER

## Series MOSFET vs 10 kV SIC

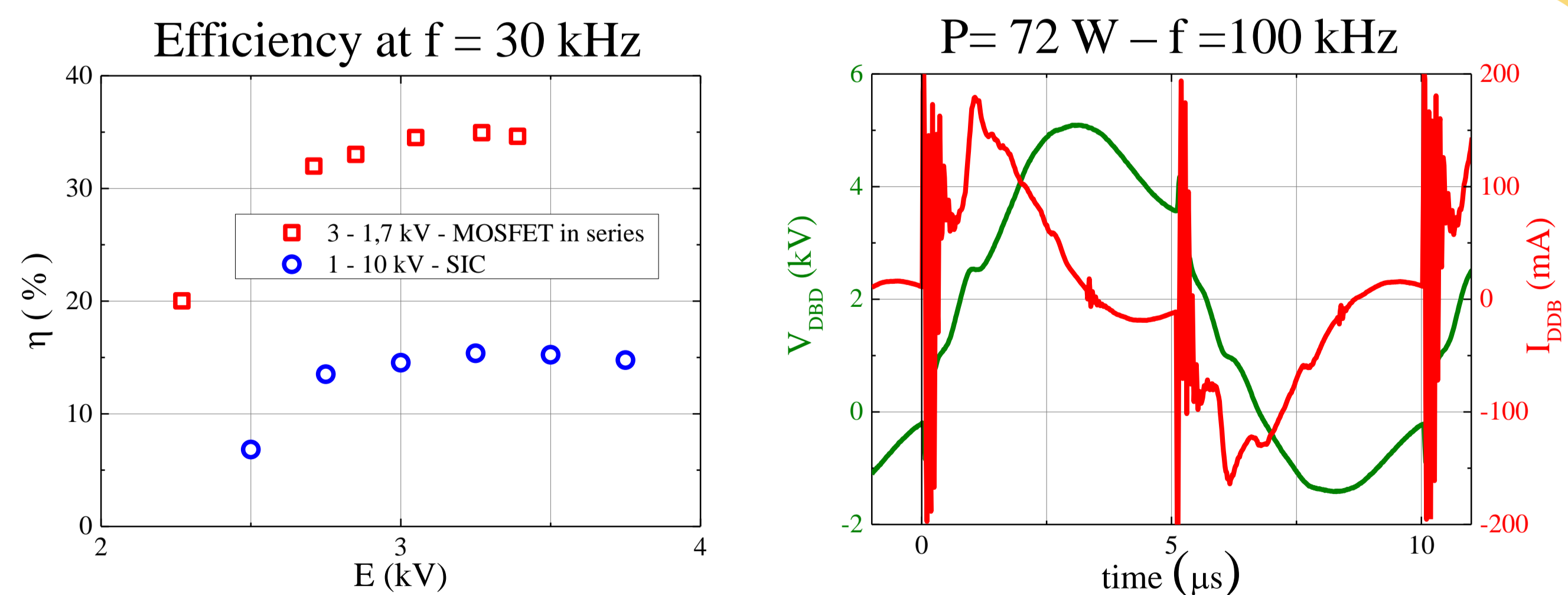

- At low power MOSFET in series are more efficient
- MOSFET in series allows to operate at frequencies up to 100 kHz
- Low  $t_{off} < 1$   $\mu$ s

## Conclusion

### Transformerless power supply

- Parasitic capacitances issues
- Over voltage on the transistor
- $C_{oss}$  implies losses at turn-ON

### SIC MOSFET 10 KV

- High  $C_{oss}$  value
- Losses depend on  $V_{DBD}$  and not on the power
- Adapted to high power applications

### MOSFET in series

- Voltage balance
- Add SNUBBER
- Well suited to low power applications