



HAL
open science

An Efficient Approach for the Frequency Analysis of Nonaxisymmetric Rotating Structures: Application to a Coupled Bladed Birotor System

Cécile Dumartineix, Benjamin Chouvion, Fabrice Thouverez, Marie-Océane Parent

► **To cite this version:**

Cécile Dumartineix, Benjamin Chouvion, Fabrice Thouverez, Marie-Océane Parent. An Efficient Approach for the Frequency Analysis of Nonaxisymmetric Rotating Structures: Application to a Coupled Bladed Birotor System. *Journal of Engineering for Gas Turbines and Power*, 2019, 141 (4), 10.1115/1.4040865 . hal-03390396

HAL Id: hal-03390396

<https://hal.science/hal-03390396>

Submitted on 28 Aug 2023

HAL is a multi-disciplinary open access archive for the deposit and dissemination of scientific research documents, whether they are published or not. The documents may come from teaching and research institutions in France or abroad, or from public or private research centers.

L'archive ouverte pluridisciplinaire **HAL**, est destinée au dépôt et à la diffusion de documents scientifiques de niveau recherche, publiés ou non, émanant des établissements d'enseignement et de recherche français ou étrangers, des laboratoires publics ou privés.

An Efficient Approach for the Frequency Analysis of Non-Axisymmetric Rotating Structures: Application to a Coupled Bladed Bi-Rotor System

Cécile Dumartineix^{*,a,b}, Benjamin Chouvion^a, Fabrice Thouverez^a, Marie-Océane Parent^b

^a École Centrale de Lyon, Laboratoire de Tribologie et Dynamique des Systèmes, UMR-CNRS 5513, 69134 Écully cedex, France

^b Safran Aircraft Engines, Rond Point René Ravaud - Réau, 77550 Moissy-Cramayel, France

ABSTRACT

The improvement of efficiency in the design of turbomachines requires a reliable prediction of the vibrating behavior of the whole structure. The simulation of blades vibrations is decisive and this is usually based on elaborated finite element model restricted to the bladed-disk. However the blades dynamic behavior can be strongly affected by interactions with other parts of the engine. Global dynamic studies that consider these other parts are required but usually come with a high numerical cost. In the case of a bi-rotor architecture, two coaxial rotors with different rotating speed can be coupled with a bearing system. The mechanical coupling between the shafts generates energy exchange that alters the dynamic behavior of the blades. The equations of motion of the whole structure that take into account the coupling contain periodic time-dependent coefficients due to the difference of rotational speed between both rotors. Equations of this kind, with variable coefficients, are typically difficult to solve. This study presents a preprocessing method to guarantee the elimination of time-dependent coefficients in the bi-rotor equations of motion. This method is tested with a simplified finite element model of two bladed-disks coupled with linear stiffnesses. We obtain accurate results when comparing frequency analysis of preprocessed equations with time-integration resolution of the initial set of equations. The developed methodology also offers a substantial time saving.

Nomenclature

A	Pseudo-stiffness matrix of the state-space system	u	Vector of physical displacements
B	Pseudo-mass matrix of the state-space system	y_k	Real part of the eigenvector <i>k</i> in state-space domain
D	Damping matrix	z_k	Imaginary part of the eigenvector <i>k</i> in state-space domain
E_s	Strain energy of the coupling stiffnesses	Φ	Complex eigenvectors matrix in state-space domain
G	Gyroscopic matrix	Ω_{1,2}	Rotating speed of rotor <i>R</i> ₁ , <i>R</i> ₂
H	Spatial harmonic	Ω	Pseudo-spectral matrix constituted of the α_k and ω_k coefficients
I_n	Identity matrix of size <i>n</i>	α_k	Modal damping coefficient of eigenmode <i>k</i>
K	Stiffness matrix	$\beta_{1,2}$	Angular position in the frame <i>R</i> ₁ , <i>R</i> ₂
K_c	Bearing coupling stiffness matrix	θ	Angular position in the stationary frame
M	Mass matrix	κ	Stiffness density
N	Spin softening matrix	λ_k	Eigenvalue of the eigenmode <i>k</i>
P	Projection matrix in the new rotating frames	Φ	Complex eigenvectors matrix in physical domain
R	Stationary frame	ω_k	Natural frequency of eigenmode <i>k</i>
R_i	Mobile frame of rotor <i>i</i>	•^B	Elements of • restricted to the bearing fixation border
R(θ)	Rotation matrix of angle θ	•_i	Elements of • associated to the rotor <i>i</i>
U	Vector of displacements for the state-space equations	l•	Elements of • associated to the left modal basis
V	Real eigenvectors matrix in physical domain	r•	Elements of • associated to the right modal basis
W	Real eigenvectors matrix in state-space domain	∧	Elements of • in modal basis
f_{ext}	External loads	∧	Elements of • after projection in the new rotating frames
j	Unit imaginary number such as $j^2 = -1$		
n_i	Blade number of the stator upstream the rotor <i>i</i>		
q	Modal coordinates		
t	Time		

*Corresponding author: cecile.dumartineix@doctorant.ec-lyon.fr

1 Introduction

Turbomachines have to ensure aerodynamic and acoustic specifications, mechanical resistance to rotational motion, high temperature and complex dynamic loads. They are intricate structures which consist of a series of bladed-disks. The separate study of each bladed-disk is not sufficient to obtain an accurate prediction of the vibrating behavior of the whole system, and it is essential to take into account the interactions between the different parts of the engine. As a finite element model of the global machine is generally not possible because of its high numerical cost, coupling phenomena are usually separately studied and then inserted in the model, which makes it even more complex.

Among these phenomena we can find accidental interactions such as blade/casing contact occurrences [1] or architectural interactions mainly due to multi-stage assemblies or bi-rotor structures. The main difficulties with modeling multi-stage assemblies are due to the loss of cyclic symmetry properties. As a cyclic-symmetric structure, a perfectly tuned bladed-disk can be modeled by a single sector [2]. In this way the number of degrees of freedom is substantially reduced without affecting the dynamic behavior of the structure. However, when two bladed-disks with various number of blades are coupled, the sectors of each blade are not concomitant. In this case the reduction methodology has to be adapted as the use of cyclic symmetry properties is not directly possible [3, 4].

In this paper, the coupling phenomenon studied comes from a bi-rotor system such as the one schematically illustrated in Fig. 1. Turbofans of this kind commonly hold two coaxial rotors with different rotating speeds. These rotors are connected by a bearing which gives rise to energy transmission and dynamic interactions between both structures. It is crucial in the design of the entire shaft line to understand and correctly predict the impact of this coupling on the blades vibrating behavior.

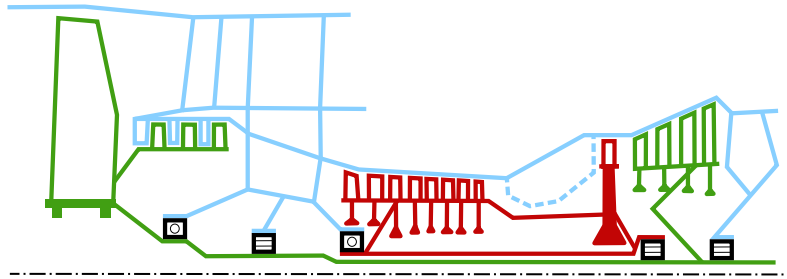

Fig. 1: Sectional view of a two-spool turbofan. Low pressure rotor (—), high pressure rotor (—), stator (—).

The choice of the reference frame to use for the equations of motion is a major concern in the study of a bi-rotor system. When the equations of motion of a non-axisymmetric rotating structure are written in a static frame, time-periodic coefficients are introduced with a period equal to the rotating speed [5]. This kind of equations, called Mathieu equations, is different of a standard eigenvalues problem theoretically time-independent. It is still possible to solve these equations of motion in a linear case [6]. But if one considers that nonlinearities like frictional contacts between blades and disk must be accounted for to accurately reproduce the dynamic behavior of bladed-disks, the equations become nonlinear and solving such nonlinear equations with time-dependent coefficients becomes laborious.

As using a static frame seems not to be the best choice, most of the time, the adopted solution to characterise the behavior of a rotating bladed-disk consists in describing its motion in a rotational frame attached to it. In that case the time-dependent coefficients are suppressed and classical equations are obtained. However the situation is largely complicated when a second bladed-disk with a different rotating speed, and its own rotational frame, gets coupled. Two separate rotating frames now exist and have to be taken into account in the expression of the coupling terms. The conversion from a frame to the other introduces new time-periodic coefficients which depend on the difference of rotating speed between both rotors. Skipping the time-dependent coupling coefficients of this Mathieu equation by substituting variable with constant terms would not be appropriate since these terms are source of instability [7, 8]. For shafts line or global dynamic studies, this difficulty is often overcome by modeling bladed-disks as simple axi-symmetric disks. In this case, the equations of motion are no longer dependent of the chosen frame which simplifies the study of two coupled rotors [9, 10]. But this simplified model ignores blades dynamic and prevents the study of the bi-rotor coupling impact on blades.

The purpose of this study is therefore to develop a preprocessing method to apply on the equations of motion of a bladed bi-rotor system in order to suppress time-dependent coefficients while preserving the dynamic behavior of the blades. With the proposed approach, usual methods of resolution or eigenmodes computation can subsequently be applied.

In this context, Salvat *et al.* [11] recently studied a rotor/stator system coupled through a bearing. They focused on the first 1-nodal diameter eigenmode of each structure and projected the equations of motion in a new frame at a rotation speed equal to half of the rotational speed of the bladed-disk. By this mean, they managed to suppress time-dependent terms in the equations of motion. We here propose to adapt their methodology to the case of two rotating structures and to generalise it so that any number of eigenmodes can be included.

2 Presentation of the studied system

The studied system represented Fig. 2, is composed of two bladed-disks turning at the distinct speeds Ω_1 and Ω_2 and coupled with a bearing. As inner and outer rings are assumed flexible, this bearing is modeled with a continuum of radial stiffness as in [11] in order to transmit any nodal diameter. The stiffness density is defined per unit length in the three directions with a matrix noted $\boldsymbol{\kappa}$ in order to allow for a more complex coupling. In our case, only the radial component is non-zero:

$$\boldsymbol{\kappa} = \begin{bmatrix} \kappa_r & 0 & 0 \\ 0 & 0 & 0 \\ 0 & 0 & 0 \end{bmatrix} \quad (1)$$

In this example the bladed-disks are directly coupled, there is no shaft line.

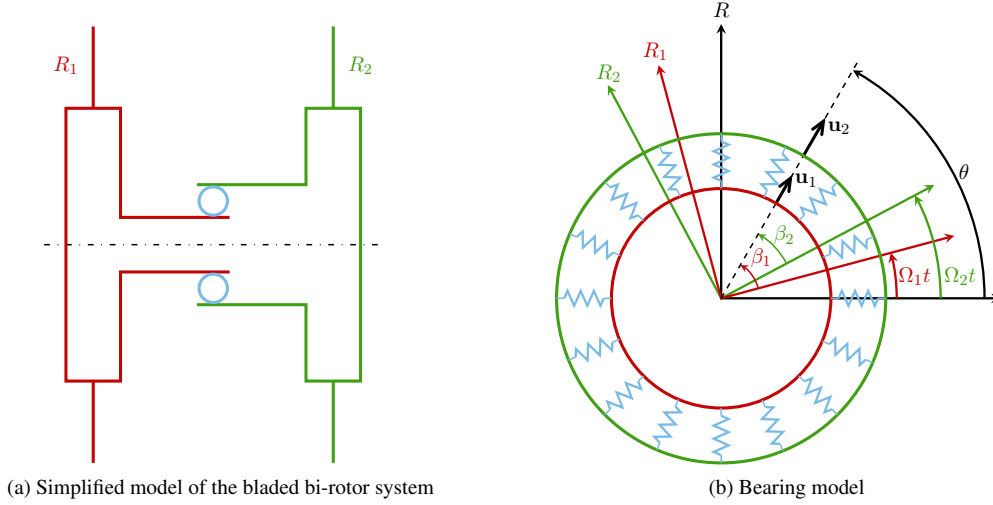

Fig. 2: Studied bi-rotor system

The two bladed-disks show cyclic symmetry properties because of the blades. It is thus better to describe their behavior in their own rotating frame in order to prevent the occurrence of time-dependent periodic terms in structural matrices. Each bladed-disk i ($i = 1$ or 2) is characterised with the finite element approach, and we note respectively \mathbf{M}_i , \mathbf{K}_i , \mathbf{D}_i , \mathbf{G}_i , and \mathbf{N}_i its matrices of mass, stiffness, damping, gyroscopic effects and spin softening expressed in its rotational frame, and \mathbf{u}_i its physical displacements. The applied external loads are noted $\mathbf{F}_{\text{ext},i}$. The equations of motion for the coupled structure write:

$$\begin{bmatrix} \mathbf{M}_1 & \mathbf{0} \\ \mathbf{0} & \mathbf{M}_2 \end{bmatrix} \begin{pmatrix} \ddot{\mathbf{u}}_1 \\ \ddot{\mathbf{u}}_2 \end{pmatrix} + \begin{bmatrix} \mathbf{D}_1 + \mathbf{G}_1 & \mathbf{0} \\ \mathbf{0} & \mathbf{D}_2 + \mathbf{G}_2 \end{bmatrix} \begin{pmatrix} \dot{\mathbf{u}}_1 \\ \dot{\mathbf{u}}_2 \end{pmatrix} + \left(\begin{bmatrix} \mathbf{K}_1 + \mathbf{N}_1 & \mathbf{0} \\ \mathbf{0} & \mathbf{K}_2 + \mathbf{N}_2 \end{bmatrix} + \begin{bmatrix} \mathbf{K}_{c1,1} & \mathbf{K}_{c1,2} \\ \mathbf{K}_{c2,1} & \mathbf{K}_{c2,2} \end{bmatrix} \right) \begin{pmatrix} \mathbf{u}_1 \\ \mathbf{u}_2 \end{pmatrix} = \begin{pmatrix} \mathbf{f}_{\text{ext},1} \\ \mathbf{f}_{\text{ext},2} \end{pmatrix} \quad (2)$$

where the subscripts $_1$ and $_2$ refer respectively to rotors R_1 and R_2 . The coupling matrix \mathbf{K}_c is deduced from the strain energy of the bearing and mathematically ensures the dynamic coupling between both structures through the extra-diagonal terms $\mathbf{K}_{c1,2}$ and $\mathbf{K}_{c2,1}$. It is important to note that these extra-diagonal terms are responsible for the time-dependent terms emergence because of the transition between the two distinct rotating frames. These terms are also essential to characterize the stability of the bi-rotor system [7]. Our objective is to identify a projection of this equation of motion onto a new basis suppressing time-dependent terms of the matrix \mathbf{K}_c without adding new ones in the other matrices.

The structural matrices have uncharacteristic forms in the physical basis. In this context it might be complicated to predict the possible addition of new time-dependent terms in their expressions. The use of a modal basis seems more suitable as the forms of the structural matrices in this basis are known and relatively simple. The first step is therefore to compute a modal basis of both rotors.

2.1 Study of a single bladed-disk

We consider the rotors separately without any bearing for the computation of their modal bases. The method developed in this section is similar for both rotors. In order to simplify notation, subscript $_1$ or $_2$ will be removed.

One way to compute the modal basis taking into account gyroscopic effects and damping is to represent the system and write the equations of motion in state-space with the state variable \mathbf{U} . The first half of this new variable consists of the physical displacements and the second half of the physical velocities:

$$\mathbf{B}\dot{\mathbf{U}} - \mathbf{A}\mathbf{U} = \mathbf{0} \quad \text{with} \quad \mathbf{U} = \begin{pmatrix} \mathbf{u} \\ \dot{\mathbf{u}} \end{pmatrix} \quad \mathbf{A} = \begin{bmatrix} \mathbf{0} & \mathbf{K} + \mathbf{N} \\ -(\mathbf{K} + \mathbf{N}) & -(\mathbf{D} + \mathbf{G}) \end{bmatrix} \quad \mathbf{B} = \begin{bmatrix} \mathbf{K} + \mathbf{N} & \mathbf{0} \\ \mathbf{0} & \mathbf{M} \end{bmatrix} \quad (3)$$

Because of the simultaneous presence of damping and gyroscopic effects, it is not possible to obtain symmetric or anti-symmetric properties for the matrix \mathbf{A} . For this reason the left and right modal bases are not analogous and have to be both computed [12]. In what follows, we will use the superscripts l and r to specify left and right. If we note λ_i the i^{th} eigenvalue and ${}^l\boldsymbol{\Phi}_i$ and ${}^r\boldsymbol{\Phi}_i$ the associated left and right eigenvectors in the physical space, the eigenvectors ${}^l\boldsymbol{\Phi}_i$ and ${}^r\boldsymbol{\Phi}_i$ in state-space take the form:

$${}^r\boldsymbol{\Phi}_i = \begin{pmatrix} {}^r\boldsymbol{\varphi}_i \\ \lambda_i {}^r\boldsymbol{\varphi}_i \end{pmatrix} \quad {}^l\boldsymbol{\Phi}_i = \begin{pmatrix} {}^l\boldsymbol{\varphi}_i \\ -\lambda_i {}^l\boldsymbol{\varphi}_i \end{pmatrix} \quad \text{with} \quad \lambda_i = -\alpha_i + j\omega_i \quad (4)$$

The real and imaginary parts of the eigenvalue λ_i are respectively the modal damping and the natural frequency of the mode i .

Because of the use of state-space representation, eigenvalues and eigenvectors appear in pair of conjugate complex values. It is however preferable to work with real terms in order to facilitate the future resolution and the retrieval of physical displacements. This is possible [12] by keeping only one vector of each conjugate complex pair and separating its real and imaginary parts into two distinct vectors. By this way, the dimension of the problem is kept without losing any information. If we write \mathbf{y}_i and \mathbf{z}_i the real and imaginary parts of a vector $\boldsymbol{\Phi}_i$, we obtain a new matrix \mathbf{W} called pseudo-modal matrix replacing the modal matrix $\boldsymbol{\Phi}$:

$$\begin{aligned} {}^r\boldsymbol{\Phi}_i &= {}^r\mathbf{y}_i + j{}^r\mathbf{z}_i & {}^r\mathbf{W} &= [{}^r\mathbf{y}_1, {}^r\mathbf{z}_1, \dots, {}^r\mathbf{y}_n, {}^r\mathbf{z}_n] \\ {}^l\boldsymbol{\Phi}_i &= {}^l\mathbf{y}_i + j{}^l\mathbf{z}_i & {}^l\mathbf{W} &= [{}^l\mathbf{y}_1, -{}^l\mathbf{z}_1, \dots, {}^l\mathbf{y}_n, -{}^l\mathbf{z}_n] \end{aligned} \quad (5)$$

It should be noted that the signs of imaginary parts \mathbf{z}_i are not the same for left and right bases. This is necessary to obtain the bi-orthogonality properties in regards to the state-space matrices \mathbf{A} and \mathbf{B} :

$$\begin{aligned} {}^l\mathbf{W}^T \mathbf{B} {}^r\mathbf{W} &= \mathbf{I}_{2n} \\ {}^l\mathbf{W}^T \mathbf{A} {}^r\mathbf{W} &= \boldsymbol{\Omega} \end{aligned} \quad \text{with} \quad \boldsymbol{\Omega} = \begin{bmatrix} -\alpha_1 & \omega_1 & 0 & 0 \\ -\omega_1 & -\alpha_1 & 0 & 0 \\ & & \ddots & \\ 0 & 0 & -\alpha_n & \omega_n \\ 0 & 0 & -\omega_n & -\alpha_n \end{bmatrix} \quad (6)$$

$\boldsymbol{\Omega}$ is called the pseudo-spectral matrix and contains the modal damping coefficient and the natural frequency of each mode. Similar to the complex eigenvectors $\boldsymbol{\Phi}$, it is possible to express the structure of real vectors in state-space \mathbf{W} according to associated vectors in physical space \mathbf{V} and the pseudo-spectral matrix $\boldsymbol{\Omega}$:

$${}^r\mathbf{W} = \begin{pmatrix} {}^r\mathbf{V} \\ {}^r\mathbf{V}\boldsymbol{\Omega} \end{pmatrix} \quad {}^l\mathbf{W} = \begin{pmatrix} {}^l\mathbf{V} \\ -{}^l\mathbf{V}\boldsymbol{\Omega}^T \end{pmatrix} \quad (7)$$

Finally, if we write ${}^l\mathbf{q}$ and ${}^r\mathbf{q}$ the modal coordinates associated with the pseudo-modal matrices indiscriminately in state- or physical space, we recover physical displacements with the relations:

$$\begin{aligned} \mathbf{U} &= {}^l\mathbf{W} {}^l\mathbf{q} & \mathbf{u} &= {}^l\mathbf{V} {}^l\mathbf{q} \\ \mathbf{U} &= {}^r\mathbf{W} {}^r\mathbf{q} & \mathbf{u} &= {}^r\mathbf{V} {}^r\mathbf{q} \end{aligned} \quad (8)$$

The left and right formulations are equivalent [12].

With these modal bases and using the bi-orthogonality properties of Eqn. (6), the equations of motion in modal basis write in the following very succinct form:

$${}^r\dot{\mathbf{q}} - \boldsymbol{\Omega}^r \mathbf{q} = \mathbf{0} \quad (9)$$

This expression will be used in the following section to write the equations of motion of the coupled system (2) in modal basis.

2.2 Coupled system written in modal basis

The approach previously developed is used to write the equations of each rotor in a modal basis with a state-space representation. Then the equations of the coupled system are created by introducing the coupling terms $\tilde{\mathbf{K}}_c$ expressed in the modal bases of both rotors:

$$\begin{pmatrix} {}^r\dot{\mathbf{q}}_1 \\ {}^r\dot{\mathbf{q}}_2 \end{pmatrix} - \begin{bmatrix} \boldsymbol{\Omega}_1 & \mathbf{0} \\ \mathbf{0} & \boldsymbol{\Omega}_2 \end{bmatrix} \begin{pmatrix} {}^r\mathbf{q}_1 \\ {}^r\mathbf{q}_2 \end{pmatrix} - \begin{bmatrix} \boldsymbol{\Omega}_1 & \mathbf{0} \\ \mathbf{0} & \boldsymbol{\Omega}_2 \end{bmatrix} \tilde{\mathbf{K}}_c \begin{pmatrix} {}^r\mathbf{q}_1 \\ {}^r\mathbf{q}_2 \end{pmatrix} = - \begin{bmatrix} \boldsymbol{\Omega}_1 & \mathbf{0} \\ \mathbf{0} & \boldsymbol{\Omega}_2 \end{bmatrix} \begin{bmatrix} {}^l\mathbf{V}_1^T & \mathbf{0} \\ \mathbf{0} & {}^l\mathbf{V}_2^T \end{bmatrix} \begin{pmatrix} \mathbf{f}_{\text{ext},1} \\ \mathbf{f}_{\text{ext},2} \end{pmatrix} \quad (10)$$

with $\tilde{\mathbf{K}}_c = \begin{bmatrix} {}^l\mathbf{V}_1^T & \mathbf{0} \\ \mathbf{0} & {}^l\mathbf{V}_2^T \end{bmatrix} \begin{bmatrix} \mathbf{K}_{c1,1} & \mathbf{K}_{c1,2} \\ \mathbf{K}_{c2,1} & \mathbf{K}_{c2,2} \end{bmatrix} \begin{bmatrix} {}^r\mathbf{V}_1 & \mathbf{0} \\ \mathbf{0} & {}^r\mathbf{V}_2 \end{bmatrix}$

The pseudo-spectral matrices $\boldsymbol{\Omega}_1$ and $\boldsymbol{\Omega}_2$ factors of the coupling terms $\tilde{\mathbf{K}}_c$ or the external loads \mathbf{f}_{ext} come from the formulation in state-space representation. With the use of the modal bases to write the equations, we need hereafter to express the coupling terms directly in modal basis in order to characterize the time-dependent coefficients.

2.3 Expression of coupling terms in modal basis

The coupling terms are deduced from the strain energy of the bearing. As the bearing is modeled with a continuum of stiffness, its strain energy E_s is expressed with an integral over its circumference. This strain energy considers only the displacements in the bearing area, which will be referred with the superscript ^B in the following derivation. With this condition, the strain energy is formulated as:

$$E_s = \frac{1}{2} \int_0^{2\pi} (\mathbf{u}_1^B(\theta) - \mathbf{u}_2^B(\theta))^T \boldsymbol{\kappa} (\mathbf{u}_1^B(\theta) - \mathbf{u}_2^B(\theta)) d\theta \quad (11)$$

The objective is to express the coupling matrices $\tilde{\mathbf{K}}_c$ directly in modal basis. To that end the decomposed expression of physical displacements in modal basis (8) is used to obtain the matrices formulation:

$$E_s = \frac{1}{2} \begin{pmatrix} {}^l\mathbf{q}_1 \\ {}^l\mathbf{q}_2 \end{pmatrix}^T \int_0^{2\pi} [{}^l\mathbf{V}_1^B \quad -{}^l\mathbf{V}_2^B]^T \boldsymbol{\kappa} [{}^r\mathbf{V}_1^B \quad -{}^r\mathbf{V}_2^B] d\theta \begin{pmatrix} {}^r\mathbf{q}_1 \\ {}^r\mathbf{q}_2 \end{pmatrix} \quad (12)$$

This equation writes under the classical form of the strain energy: $E_s = \frac{1}{2} \mathbf{q}^T \mathbf{K} \mathbf{q}$ with \mathbf{q} the modal coordinates of both rotors and \mathbf{K} a stiffness matrix formulated in modal basis. Then, the expression of the coupling matrix in modal basis $\tilde{\mathbf{K}}_c$ is directly deduced as:

$$\tilde{\mathbf{K}}_c = \int_0^{2\pi} [{}^l\mathbf{V}_1^B \quad -{}^l\mathbf{V}_2^B]^T \boldsymbol{\kappa} [{}^r\mathbf{V}_1^B \quad -{}^r\mathbf{V}_2^B] d\theta \quad (13)$$

At this stage, more information about the spatial form of continuous modal vectors at the bearing is needed to develop the integral of (13) and accurately establish the structure of time-dependent coefficients in the matrix $\tilde{\mathbf{K}}_c$.

2.3.1 Splitting of eigenmodes on spatial harmonics

In order to establish an assumption on the form of modal vectors that is consistent with the vibrating behavior of the structure, we focus on the rotors geometry at the bearing area. As represented in Fig. 3, the bearing is situated on an axi-symmetric area of the bladed-disk, far away from the blades. We therefore suppose that the vibrating behavior of this zone is axi-symmetric

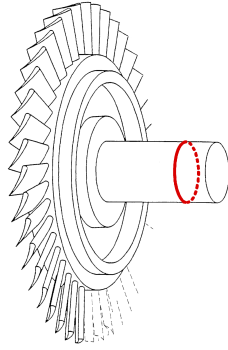

Fig. 3: Fixing area of the bearing (red line) on one bladed-disk for our studied case

and model this section of the structure as a perfect ring. This assumption is particularly useful because each eigenmode of a ring can be spatially modeled with a single spatial harmonic [13, 14]. Thus, a modal vector k of the rotor i restricted to the bearing area can be written in the form:

$$\mathbf{V}_{i,k}^B(\beta_i) = \mathbf{a} \cos(H\beta_i) + \mathbf{b} \sin(H\beta_i) \quad (14)$$

where H is the number of the spatial harmonic present in the form of this eigenmode, and β_i the angular position in the rotating frame associated with the rotor R_i as defined in Fig. 2. In our model, to determine the coefficient vectors \mathbf{a} and \mathbf{b} , and the associated harmonic H , we perform a spatial Fourier transform of the modal basis at the bearing area, as proposed in [15] for an asymmetric structure. Only one set of parameters is kept for each vector to satisfy the assumption of mono-harmonic spatial decomposition. The set chosen is the one that shows maximum magnitude of \mathbf{a} and \mathbf{b} .

The computation of the integral in Eqn. (13) requires to write eigenvectors of both rotors according to the same angle. The angular position θ in the static frame is chosen (Fig. 2), which introduces a time dependence in the expression of eigenvectors at the bearing area:

$$\begin{aligned} \beta_i &= \theta - \Omega_i t \\ \mathbf{V}_{i,k}^B(\theta, t) &= \mathbf{a} \cos H(\theta - \Omega_i t) + \mathbf{b} \sin H(\theta - \Omega_i t) \end{aligned} \quad (15)$$

2.3.2 Structure of the coupling matrix

With this particular formulation for the modal basis, we can compute the integral in the expression of the coupling terms (13). The main interest of using this Fourier transform is that the trigonometric functions are orthogonal. Consequently we expect a lot of terms in the matrix $\tilde{\mathbf{K}}_c$ to be zero. In fact, we observe in the structure of the matrix $\tilde{\mathbf{K}}_c$ that every terms coupling two eigenmodes with a different spatial harmonic are effectively equal to zero. On the contrary, the coupling terms between two eigenmodes with the same spatial harmonic H are non-zero coefficients. If the two considered eigenmodes belong to the same rotor, then the associated coefficients in the coupling matrix are constant. But if the two eigenmodes belong to different rotors, the associated coefficients are time-dependent and appear in the form of a rotation matrix \mathbf{R} of angle γ depending on the speed difference between both rotors and the spatial harmonic H detected in this pair of eigenmodes:

$$\mathbf{R}(\gamma) = \begin{bmatrix} \cos \gamma & \sin \gamma \\ -\sin \gamma & \cos \gamma \end{bmatrix} \quad \gamma = H(\Omega_2 - \Omega_1)t \quad (16)$$

It physically means that the modes which can exchange energy through the bearing are those that contain the same spatial harmonic H . The associated periodic time-dependent terms in the coupling matrix consist of a change of rotating frame proportional to the speed difference between both rotors: these terms derive directly from the initial formulation of the equations in two different rotating frames. As the coupling terms link both equations, it becomes necessary to account for the fact that both frames are different.

3 Projection of the equations of motion

Now that the general form of the time-dependent coefficients in the coupling matrix $\tilde{\mathbf{K}}_c$ is known, we can look for a projection which suppresses these terms. As presented in the previous section, the periodic time-dependent coefficients are

expressed as rotation matrices. This construction is advantageous because a rotation is easily deleted with the application of an inverse rotation.

In the present case, the angle γ (see Eqn. (16)) of each rotation matrix to be deleted is proportional to the speed difference between both rotors. One solution could be to project the pair of coupling eigenmodes in a common rotating frame in order to prevent the change of frame in the computation of coupling terms. However, the rotation matrices to be deleted are also depending on the number of the harmonic H detected in concerned eigenmodes. Consequently the choice of the common frame to project coupled eigenmodes has to take into account this harmonic H . Thus the rotation matrices to be applied to two vectors of both rotors with the same harmonic H are respectively of angle $H\Omega_1 t$ and $H\Omega_2 t$.

Therefore there will be as many projection frames as the number of different harmonics H detected in eigenmodes of both structures. It is for that reason that the hypothesis of a ring behavior with only one spatial harmonic per eigenvector is essential. In fact, it would not be possible to suppress simultaneously the time-dependent terms for an eigenmode with several spatial harmonics H . This assumption could be invalidated in some cases as for a non-circular shaft for which several harmonics are necessary to describe each eigenmode. In that case, the projection method should be reexamined. Other practical simulations such as blade mistuning can be treated with the proposed projections if the mistuning effects are located onto the blades without significant alterations of the vibrating behavior in the bearing area.

The projection matrix \mathbf{P} to suppress all periodic time-dependent coefficients of the coupling matrix $\tilde{\mathbf{K}}_c$ is easily built when knowing the spatial harmonic H of each eigenmodes. The matrix \mathbf{P} is a block diagonal matrix containing the rotation matrices defined earlier. The angle of rotation of those matrices is function of the harmonic H detected in the associated eigenvector. The matrix \mathbf{P} can be partitioned in two parts: \mathbf{P}_1 for the rotor R_1 and \mathbf{P}_2 for the rotor R_2 . An example of this matrix is given hereunder:

$$\mathbf{P} = \left[\begin{array}{ccc|ccc} 1 & \mathbf{0} & \mathbf{0} & & & \\ \mathbf{0} & \mathbf{R}(H_1\Omega_1 t) & \mathbf{0} & & & \\ \mathbf{0} & \mathbf{0} & \mathbf{R}(H_2\Omega_1 t) & & & \\ \hline & & & 1 & \mathbf{0} & \mathbf{0} & \mathbf{0} \\ & & & \mathbf{0} & \mathbf{R}(H_2\Omega_2 t) & \mathbf{0} & \mathbf{0} \\ & & & \mathbf{0} & \mathbf{0} & \mathbf{R}(H_3\Omega_2 t) & \mathbf{0} \\ & & & \mathbf{0} & \mathbf{0} & \mathbf{0} & \mathbf{R}(H_1\Omega_2 t) \end{array} \right]$$

By applying this projection to the coupling matrix in modal basis $\tilde{\mathbf{K}}_c$, we finally obtain a constant time-independent coupling matrix $\hat{\mathbf{K}}_c$:

$$\hat{\mathbf{K}}_c = \mathbf{P}^T \tilde{\mathbf{K}}_c \mathbf{P} \quad (17)$$

3.1 Projection of the other terms of the equations of motion

The projection matrix \mathbf{P} has been built in order to ensure the elimination of time-dependent coefficients in the coupling matrix. It is now necessary to confirm that this projection will not create new time-dependent coefficients in the other matrices of the equations of motion. The projection of the equations of motion (10) implies the change of variable:

$$\mathbf{q} = \mathbf{P}\hat{\mathbf{q}} \quad (18)$$

The fact that the equations of motion are written in modal basis facilitates this step of validation thanks to the simple form of the obtained matrices. The structure of the pseudo-spectral matrix $\mathbf{\Omega}$ is indeed rotation invariant. Then, by using the change of variable (18) and left multiplying Eqn. (10) by \mathbf{P}^T , the projected equations of motion result in:

$$\begin{pmatrix} \dot{\hat{\mathbf{q}}}_1 \\ \dot{\hat{\mathbf{q}}}_2 \end{pmatrix} + \left(\mathbf{P}^T \dot{\mathbf{P}} - \begin{bmatrix} \mathbf{\Omega}_1 & \mathbf{0} \\ \mathbf{0} & \mathbf{\Omega}_2 \end{bmatrix} - \begin{bmatrix} \mathbf{\Omega}_1 & \mathbf{0} \\ \mathbf{0} & \mathbf{\Omega}_2 \end{bmatrix} \begin{bmatrix} \hat{\mathbf{K}}_{c1,1} & \hat{\mathbf{K}}_{c1,2} \\ \hat{\mathbf{K}}_{c2,1} & \hat{\mathbf{K}}_{c2,2} \end{bmatrix} \right) \begin{pmatrix} \hat{\mathbf{q}}_1 \\ \hat{\mathbf{q}}_2 \end{pmatrix} = \begin{pmatrix} -\mathbf{P}_1^T \mathbf{\Omega}_1^T \mathbf{V}_1^T \mathbf{f}_{\text{ext},1} \\ -\mathbf{P}_2^T \mathbf{\Omega}_2^T \mathbf{V}_2^T \mathbf{f}_{\text{ext},2} \end{pmatrix} \quad (19)$$

The term $\mathbf{P}^T \dot{\mathbf{P}}$ is here time-independent thanks to the orthogonal properties of trigonometric functions. With this new formulation, the main objective is achieved: every matrices of the equations of motion are time-independent.

3.2 Consequence of the projection on the external loads

The form of the applied external loading does not affect the preprocessing of the equations of motion but directly impact the resolution strategy. For an arbitrary load, time-resolution may be necessary; for a sinusoidal load, frequency resolution may be more efficient if only the stationary solution is sought after.

In this example, we assume that the external loads are aerodynamic loads generated by the wakes of stators located upstream of both bladed-disks. These loads are applied at the tip of the blades in three directions. The time evolution of this kind of loads is complex and will be approximated by a sinusoidal excitation. For two stators with respectively n_1 and n_2 blades, the excitation frequencies seen by the rotors are $n_1\Omega_1$ and $n_2\Omega_2$. The associated loads expressed in the mobile frames of both rotors are written as:

$$\begin{aligned}\mathbf{f}_{\text{ext},1}(r_1, \beta_1, x_1, t) &= \mathbf{a}_1(r_1, x_1) \cos n_1(\Omega_1 t + \beta_1) + \mathbf{b}_1(r_1, x_1) \sin n_1(\Omega_1 t + \beta_1) \\ \mathbf{f}_{\text{ext},2}(r_2, \beta_2, x_2, t) &= \mathbf{a}_2(r_2, x_2) \cos n_2(\Omega_2 t + \beta_2) + \mathbf{b}_2(r_2, x_2) \sin n_2(\Omega_2 t + \beta_2)\end{aligned}\quad (20)$$

with $r_{i=1,2}$ and $x_{i=1,2}$ the radial and axial positions, and $\beta_{i=1,2}$ the angular positions as represented Fig. 2. The projection of the external loads on the basis formed by \mathbf{P} increases the number of harmonics in the load spectrum. For instance, for each spatial harmonic H in the modal basis of the rotor R_1 , the harmonics $(H + n_1)\Omega_1 t$ and $(H - n_1)\Omega_1 t$ emerge in the load spectrum of the rotor after projection. The load spectrum of the second rotor is similar.

As a result, we obtain two fundamental frequencies in the load spectrum of the coupled system: Ω_1 and Ω_2 . Most of the time, these rotational speeds are incommensurable and need a multi-frequency resolution. In a linear case, as in the current study, it is possible to apply the principle of superposition. The equations of motion are solved in the frequency domain separately for each harmonic $(H \pm n_{1,2})\Omega_{1,2}t$ of the load spectrum, and the resulting solutions are summed. In the case of a nonlinear study, an adaptation of the Harmonic Balance Method (HBM) that directly solves for the stationary solution seems particularly suitable. The most general adapted method that uses a multi-dimensional time domain [16] induces a high numerical cost due to the appearance of a large combination of the incommensurable frequencies, which are not always significant in our problem. Other methods limited to two fundamental frequencies exist like the Variable Coefficient HBM [17] or multi-scale approaches [18, 19]. Another strategy based on the HBM with quasi-periodic Fourier transform [20, 21] could be relevant.

4 Numerical applications

The frequency resolution of the preprocessed equations developed in this paper is applied to a bi-rotor system and will be compared, when possible, to a time integration of the initial equations for validation purposes.

4.1 Finite element model studied

The numerical applications in this paper are based on a finite element model of a simplified bi-rotor system presented in Fig. 4. These bladed-disks have respectively 48 and 24 sectors. The coupling stiffnesses are not represented here but are fixed on each rotor on a circular line of each mesh.

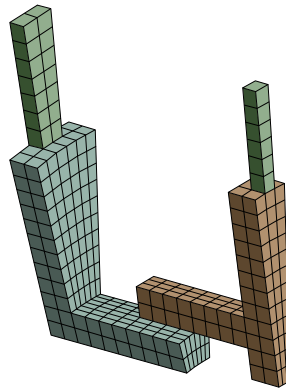

Fig. 4: Finite element model of one sector of each bladed-disk of the studied bi-rotor system

The matrices of mass and stiffness are generated for one sector of each rotor with a commercial finite element software. The gyroscopic effects are neglected and a matrix of modal damping is defined. Furthermore, the cyclic symmetry properties of both structures are exploited to improve the efficiency of the modal basis computation. The two sectors brought together have 1872 degrees of freedom (DoF) versus 31506 for the full structure. The previously defined loading is applied in the axial direction at the tip of the blades.

4.2 Validation of the preprocessing method

A time integration resolution of the initial equation is chosen as reference in order to validate our proposed methodology. The results of this time integration are directly compared with the frequency resolution of the preprocessed equation. Time integration methods present the interest to be well-known and to be adapted to solve equations with time-dependent coefficients despite their high numerical cost. Ideally, this resolution should be applied on the initial equations of motion without any transformation. But in our case, the equation is first written in modal basis in order to reduce the number of DoF and the associated computation time that proves to be already expensive. The same modal basis, truncated to the two first eigenmodes of each nodal diameter, is used in our proposed approach.

A straightforward configuration of the bi-rotor system is chosen for this validation step. A aerodynamic load is applied only on the blades of the first rotor. As the only way in this particular case to excite the second rotor is through the bearing, the first rotor is excited on an eigenmode for which the deformation in the bearing area is significant.

The first mode with two nodal diameters of the first rotor (Fig. 5) is chosen as it presents a substantial distortion of the bearing area. The natural frequency of this mode is $\omega_1 = 20826 \text{ rad.s}^{-1}$. Consequently a load with two wakes is

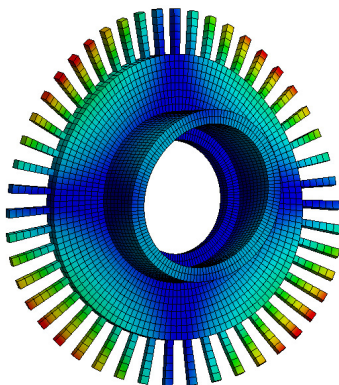

Fig. 5: Modal deformation of the first 2-diameter mode of the rotor R_1 .

applied in order to be spatially compatible with this 2-diameter mode, and the rotation speed of the rotor is imposed as $\Omega_1 = 10413 \text{ rad.s}^{-1}$ in order to obtain the required frequency. The rotation speed of the second rotor is arbitrarily chosen as $\Omega_2 = 1000 \text{ rad.s}^{-1}$.

Figure 6 illustrates the radial displacement of a node in the bearing area of each rotor calculated with time integration and our proposed frequency resolution. Similar results can be found for axial displacements of the tip of blades. We observe for

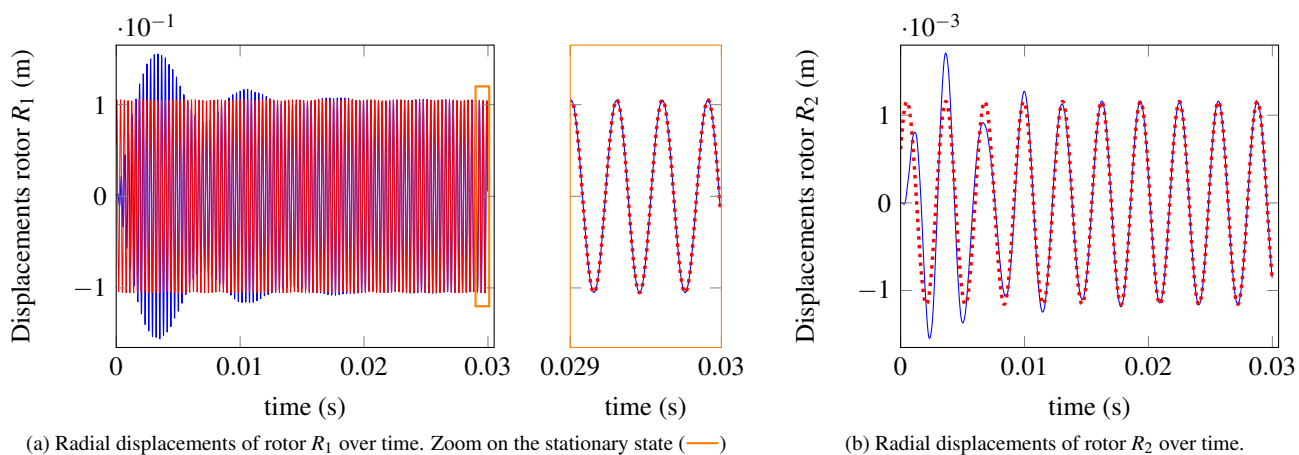

Fig. 6: Time radial displacements of a node of each rotor in the bearing area. Time integration of the initial equation of motion (—), frequency resolution of the preprocessed equation (.....).

the time resolution of the rotor R_1 a relatively long transient response which imposes lots of iterations before reaching the

stationary state. This constraint increases the computing time already expensive for this method.

Once the stationary state is reached, Fig. 6 shows for both rotors an accurate superposition of the results obtained with each method. The hypothesis about writing eigenmodes on a single spatial harmonic seems reasonable since both computations give the same results.

Initially not excited with external loading, the rotor R_2 presents significant displacements thanks to the energy transfer through the bearing. As expected, the magnitudes of displacement on the rotor R_2 which depend on the bearing stiffnesses are lower than R_1 because the excitation is directly on R_1 .

Finally, for the rotor R_1 we find that the frequency of the forced response is equal to the excitation frequency as expected; for the rotor R_2 , the response frequency is twice the rotation speed of this rotor, which is conform with a two-diameter excitation.

Other simulations have been performed with different configurations of the bi-rotor system (rotation speeds, excitation frequency of both rotors) giving always similar results between both methodologies of resolution. However, the computation costs are substantially different: for the present example, around 6 hours were necessary for the time integration of the initial equations in modal basis versus 5 minutes to built the preprocessed equations and solve them in the frequency domain. To conclude, the method presented in this paper gives very accurate results with a significant time saving.

4.3 Study of the bi-rotor vibrating behavior with a two-diameter excitation

Once the method has been validated for several configurations of the bi-rotor system, it can be used to study the vibrating behavior of the structure in a large range of rotation speeds. This kind of parameter study cannot be considered with time integration process because of a too expensive computing time.

For this example, the same loads than previously are used: a two wakes load for the rotor R_1 and no load for the rotor R_2 . The computations are performed for several speed values of each rotor staggered from 0 to 15000 rad.s^{-1} . The rotors are then co-rotative. The speed range has been chosen to cross the first 2-diameter mode of each bladed-disk. With uncoupled configuration, the associated values of natural frequencies are respectively $\omega_1 = 20826 \text{ rad.s}^{-1}$ et $\omega_2 = 16636 \text{ rad.s}^{-1}$. Taking into account the spatial repartition of the loads with two wakes, significant vibratory responses are expected at around half of the natural frequencies, that are: $\Omega_1 = 10400 \text{ rad.s}^{-1}$ and $\Omega_2 = 8300 \text{ rad.s}^{-1}$.

The map of maximal radial displacements for one node in the bearing area of each rotor is plotted Fig. 7a. One specific speed value of each rotor generates a clear increase in the magnitude of displacements: $\Omega_1 = 10850 \text{ rad.s}^{-1}$ and $\Omega_2 = 8350 \text{ rad.s}^{-1}$. These speeds are slightly higher than the expected ones in the case of uncoupled rotors due to the presence of the bearing stiffness. At the intersection of these speeds, a particular phenomenon appears. A zoom on this area is plotted in Fig. 7b. We observe an energy transfer from the excited rotor R_1 towards the coupled rotor R_2 that induces a decrease of the magnitude of displacements of the rotor R_1 in exchange for an increase of the rotor R_2 . It should also be noted that apart from the coincidence of these two specific speeds, the rotor R_1 is barely not affected by the resonance of the rotor R_2 . On the contrary, both resonances are visible with the same magnitude of displacements on the map of the rotor R_2 .

5 Conclusion

The work presented in this paper provides a methodology to delete the periodic time-dependent coefficients in the equations of motion of two bladed rotors coupled with a bearing system. Each rotor is described separately in its own rotational frame when computing its modal basis. The calculated eigenmodes restricted to the bearing area are then split up into spatial harmonics. Modal basis of both rotors are paired according to spatial harmonics detected in their eigenmodes. Finally, pairs of eigenmodes are projected into a common frame depending on the spatial harmonic of each pair. As a result the external loads spectrum is extended but time-dependent coefficients are suppressed. Frequency analysis or eigenmodes computation can subsequently be easily applied.

The main hypothesis of this method is to model the bearing area with a ring, which assures axi-symmetric properties for the vibrating behavior of this limited region.

The method is tested with a simplified finite element model of two bladed-disks coupled with linear stiffnesses. Due to the linearity of the system, preprocessed equations can be solved in the frequency domain using the principle of superposition. The comparison of the developed method with a time integration solution of the initial equation gives accurate results with a substantial time saving. The main hypothesis seems therefore reasonable.

This approach is then applied for the study of the vibrating behavior of a co-rotative bi-rotor system on a range of rotation speeds. A remarkable energy transfer is observed at the intersection of the natural frequencies of both rotors. Such a parametric study would not be achieved with time integration methods because of their high numerical cost.

Further work may extend the study to nonlinear field with introduction of nonlinearities in the system. It would then be necessary to develop a nonlinear multi-frequency approach capable of solving industrial size models.

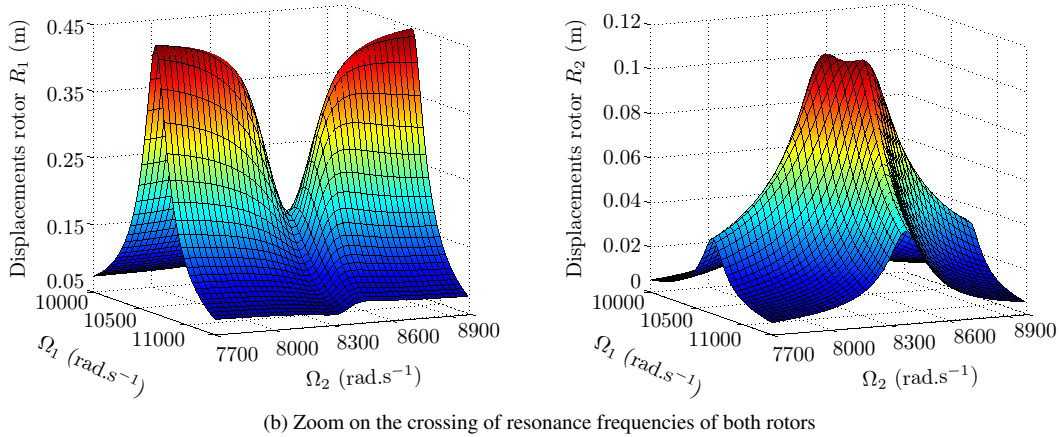
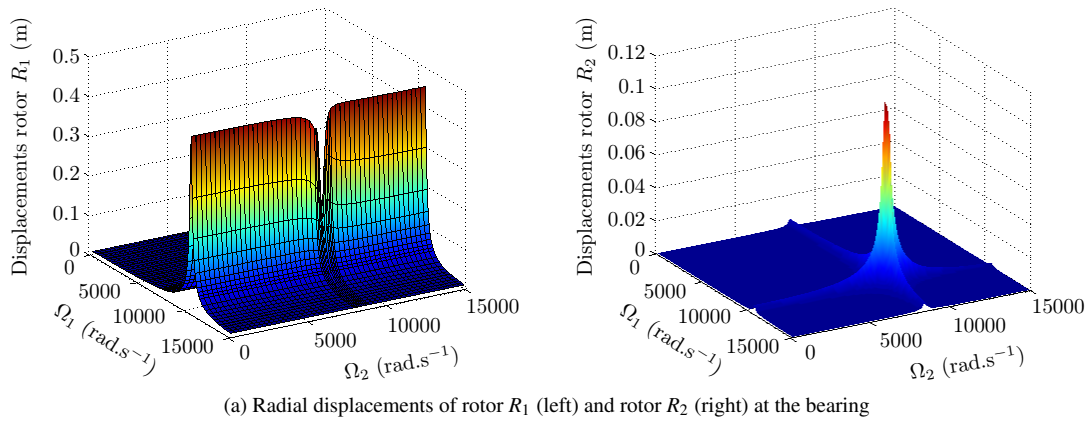

Fig. 7: Maximum radial displacements of a node of each rotor in the bearing area computed for a range of rotation speeds with a co-rotative configuration.

Acknowledgements

The authors acknowledge Safran Aircraft Engines for providing the financial support of this project and for giving permission to publish this work.

References

- [1] Legrand, M., Pierre, C., Cartraud, P., and Lombard, J.-P., 2009. “Two-dimensional modeling of an aircraft engine structural bladed disk-casing modal interaction”. *Journal of Sound and Vibration*, **319**(1), pp. 366 – 391.
- [2] Thomas, D.L., 1979. “Dynamics of rotationally periodic structures”. *International Journal for Numerical Methods in Engineering*, pp. 81 – 102.
- [3] Laxalde, D., Thouverez, F., and Lombard, J.P., 2007. “Dynamical analysis of multi-stage cyclic structures”. *Mechanics Research Communications*, pp. 379–384.
- [4] Battiato, G., Fironne, C.M., Berruti, T.M., and Epureanu, B.I., 2016. “Reduced order modeling for multi-stage coupling of cyclic symmetric structures”. *Proceedings of ISMA*, pp. 3447 – 3462.
- [5] Ewins, D.J., 2000. *Modal testing : theory, practice and application*, second ed. Research Studies Press Wiley.
- [6] Shapiro, V.E., 2001. “Rotating class of parametric resonance processes in coupled oscillators”. *Physics Letters A*, pp. 288–296.
- [7] Pradeep, S., and Shrivastava, S. K., 1988. “On the stability of the damped mathieu equation”. *Mechanics Research Communications*, **15**(6), pp. 353 – 359.
- [8] Mond, M., Cederbaum, G., Khan, P.B., and Zarmi, Y., 1993. “Stability analysis of the non-linear mathieu equation”. *Journal of Sound and Vibration*, **167**(1), pp. 77 – 89.
- [9] Lalanne, M., and Ferraris, G., 2000. *Rotordynamics Prediction in Engineering*, second ed. Wiley.
- [10] Guin, M., Thouverez, F., Blanc, L., and Jean, P., 2011. “Nonlinear dynamics of a bladed dual-shaft”. *European Journal of Computational Mechanics*, **20**(1-4), pp. 207–225.
- [11] Salvat, N., Batailly, A., and Legrand, M., 2015. “Two-dimensional modeling of unilateral contact-induced shaft

- precessional motions in bladed-disk/casing systems”. *International Journal of Non-Linear Mechanics*, pp. 90 – 104.
- [12] Gmür, T., 1997. *Dynamique des structures: analyse modale numérique*. Presses polytechniques et universitaires romandes.
- [13] Timoshenko, S., 1937. *Vibration problems in engineering*, second ed. D.Van Nostrand Company INC.
- [14] Rao, S.S., 2007. *Vibration of Continuous Systems*. Wiley.
- [15] Lazarus, A., Prabel, B., and Combescure, D., 2010. “A 3d finite element model for the vibration analysis of asymmetric rotating machines”. *Journal of Sound and Vibration*, **329**(18), pp. 3780 – 3797.
- [16] Guskov, M., Sinou, J.J., and Thouverez, F., 2008. “Multi-dimensional harmonic balance applied to rotor dynamics”. *Mechanics Research Communications*, pp. 537–545.
- [17] Zhou, B., Thouverez, F., and Lenoir, D., 2015. “A variable-coefficient harmonic balance method for the prediction of quasi-periodic response in nonlinear systems”. *Mechanical Systems and Signal Processing*, pp. 233–244.
- [18] Feldmann, P., and Roychowdhury, J., 1996. “Computation of circuit waveform envelopes using an efficient, matrix-decomposed harmonic balance algorithm”. *IEEE*, pp. 295–300.
- [19] Laxalde, D., 2007. “Étude d’amortisseurs non-linéaires appliqués aux roues aubagées et aux systèmes multi-étages”. Thèse de doctorat, Ecole Centrale de Lyon.
- [20] Kundert, K.S., Sorkin, G.B., and Sangiovanni-Vincentelli, A., 1988. “Applying harmonic balance to almost-periodic circuits”. *IEEE transactions on microwave theory and techniques*, pp. 366–378.
- [21] Guédeney, T., Gomar, A., Gallard, F., F.Sicot, Dufour, G., and Puigt, G., 2013. “Non-uniform time sampling for multiple-frequency harmonic balance computations”. *Journal of Computational Physics*, pp. 317–345.