



HAL
open science

Coupling between production of ribosomal RNA and maturation: just at the beginning

Chaima Azouzi, Mariam Jaafar, Christophe Dez, Raghida Abou Merhi, Annick Lesne, Anthony K Henras, Olivier Gadal

► To cite this version:

Chaima Azouzi, Mariam Jaafar, Christophe Dez, Raghida Abou Merhi, Annick Lesne, et al.. Coupling between production of ribosomal RNA and maturation: just at the beginning. *Frontiers in Molecular Biosciences*, In press, 10.3389/fmolb.2021.778778 . hal-03380240

HAL Id: hal-03380240

<https://hal.science/hal-03380240v1>

Submitted on 15 Oct 2021

HAL is a multi-disciplinary open access archive for the deposit and dissemination of scientific research documents, whether they are published or not. The documents may come from teaching and research institutions in France or abroad, or from public or private research centers.

L'archive ouverte pluridisciplinaire **HAL**, est destinée au dépôt et à la diffusion de documents scientifiques de niveau recherche, publiés ou non, émanant des établissements d'enseignement et de recherche français ou étrangers, des laboratoires publics ou privés.

Coupling between production of ribosomal RNA and maturation: just at the beginning

Chaima Azouzi¹, Mariam Jaafar^{1,3}, Christophe Dez¹, Raghida Abou Merhi², Annick Lesne^{4,5}, Anthony K. Henras^{1*} and Olivier Gadal^{1*}

¹ Laboratoire de Biologie Moléculaire, Cellulaire et du Développement (MCD), Centre de Biologie Intégrative (CBI), Université de Toulouse, CNRS, UPS, 31062 Toulouse, France;

² Genomic Stability and Biotherapy (GSBT) Laboratory, Faculty of Sciences, Rafik Hariri Campus, Lebanese University, Lebanon;

³ Present address: Cancer Research Center of Lyon (CRCL), 69 008 Lyon, France.

⁴ Sorbonne Université, CNRS, Laboratoire de Physique Théorique de la Matière Condensée, LPTMC, Paris, France

⁵ Institut de Génétique Moléculaire de Montpellier, IGMM, Univ. Montpellier, CNRS, Montpellier, France.

* Correspondence:

anthony.henras@univ-tlse3.fr (A.K.H.); olivier.gadal@univ-tlse3.fr (O.G.);

Keywords: RNA polymerase I (RNAPI); ribosomal RNA (rRNA); ribosomal RNA maturation ;

Abstract

Ribosomal RNA (rRNA) production represents the most active transcription in the cell. Synthesis of the large rRNA precursors (35S/47S in yeast/human) is achieved by up to hundreds of RNA polymerase I (Pol I) enzymes simultaneously transcribing a single rRNA gene. In this review, we present recent advances in understanding the coupling between rRNA production and nascent rRNA folding. Mapping of the distribution of Pol I along ribosomal DNA at nucleotide resolution, using either native elongating transcript sequencing (NET-Seq) or crosslinking and analysis of cDNAs (CRAC), revealed frequent Pol I pausing, and CRAC results revealed a direct coupling between pausing and nascent RNA folding. High density of Pol I per gene imposes topological constraints that establish a defined pattern of polymerase distribution along the gene, with a persistent spacing between transcribing enzymes. RNA folding during transcription directly acts as an anti-pausing mechanism, implying that proper folding of the nascent rRNA favors elongation *in vivo*. Defects in co-transcriptional folding of rRNA are likely to induce Pol I pausing. We propose that premature termination of transcription, at defined positions, can control rRNA production *in vivo*.

35

36 **Synthesis of the 35S primary transcript by Pol I**

37 Yeast haploid cells contain between 150 and 200 copies of tandemly repeated rRNA genes
38 while the diploid human genome contains around 400 copies. Although present at a high copy
39 number in the genomes, not all rRNA genes are actively transcribed. In budding yeast, only about
40 50% of the genes on average are transcribed in exponentially growing cells. Each ribosomal gene
41 unit spreads over 9.1 kb of DNA and contains two transcribed regions encoding the 35S pre-rRNA,
42 transcribed by RNA Polymerase I (Pol I), and the 5S rRNA, transcribed by Pol III (Figure 1A). These
43 transcribed regions are separated by intergenic spacers (IGSs): IGS1 starts at the transcription
44 termination site of the 35S gene and ends at the 5S rRNA gene terminator and IGS2 corresponds to
45 the region between the 5S rRNA gene promoter and the promoter of the next 35S gene (Nomura,
46 2001). Pol I transcription accounts for almost 60% of total transcriptional activity in yeast cells
47 (Warner, 1999). This process occurs in the nucleolus and results in the synthesis of the 35S pre-
48 rRNA containing the sequences of three of the four rRNAs composing the mature ribosome, the 18S,
49 5.8S and 25S rRNAs. These sequences are flanked and separated by sequences that are not retained
50 in the mature ribosomes: respectively the 5' and 3' external transcribed spacers (5' ETS and 3' ETS)
51 and the internal transcribed spacers 1 and 2 (ITS1 and ITS2) (Figure 1A). This 35S precursor will be
52 co-transcriptionally packaged into pre-ribosomal particles that will undergo a complex maturation
53 pathway to generate the mature ribosomal subunits.

54 **Transcription initiation and termination**

55 Pol I enzyme in yeast is composed of 14 subunits (global molecular weight of 590 kDa)
56 including two large subunits, Rpa190 and Rpa135, jointly forming the active site of the enzyme
57 (Riva et al., 1987) (Figure 1B). Crystal structure of yeast *Saccharomyces cerevisiae* Pol I revealed
58 the interactions occurring between its 14 subunits: the two large subunits Rpa190 and Rpa135
59 organize the enzyme in two modules of similar mass (Engel et al., 2013; Fernández-Tornero et al.,
60 2013). The Pol I-specific subunits whose role during transcription has been partially characterized
61 include Rpa43 and Rpa14 subunits in the stalk, and Rpa34, Rpa49 and Rpa12 subunits associated
62 with the jaw/lobe module (Figure 1B).

63 Formation of preinitiation complex (PIC) is presented in Figure 1C. Pol I promoter contains
64 two sequences required for efficient transcription initiation: the upstream activating sequences (UAS)
65 and the core element (CE) (Boukhgalter et al., 2002; Nomura, 2001). Recruitment of the polymerase
66 to the promoter to form the PIC relies on four transcription factors: upstream activating factor (UAF),
67 core factor (CF), TATA-binding protein (TBP) and the Rrn3 transcription factor (Keener et al.,
68 1998). UAF is the first complex to associate with the UAS of the rDNA promoter to initiate PIC
69 assembly (Steffan et al., 1996). TBP was shown to bind to both CF and UAF, thus serving as a bridge
70 to position CF downstream of the UAS. Binding of CF to the CE allows further recruitment of Pol I
71 stably associated with Rrn3 (Aprikian et al., 2001). Rrn3 is a highly conserved transcription factor
72 that associates with the Rpa43-Rpa14 heterodimer of Pol I and interacts with the Rrn6 subunit of the
73 CF. It is therefore a crucial element required for transcription initiation (Peyroche et al., 2000;
74 Aprikian et al., 2001). Transcription begins at the transcription start site (TSS) and Pol I and Rrn3 are
75 released from the PIC upon transcription initiation. Several structural studies gave new insights into
76 Pol I promoter recognition and melting, and more broadly into transcription initiation by yeast Pol I
77 (Sadian et al., 2017; Tafur et al., 2019; Sadian et al., 2019; Moreno-Morcillo et al., 2014; Tafur et al.,

78 2016; Neyer et al., 2016; Engel et al., 2016, 2013; Blattner et al., 2011; Han et al., 2017; Knutson et
79 al., 2020; Smith et al., 2018). These studies will not be detailed here.

80 Pol I transcription termination involves pausing induced by a terminator protein, leading to
81 dissociation of the polymerase and release of the primary transcript. Paradoxically, termination is not
82 required for rRNA production since nascent transcript is released through the endonucleolytic
83 cleavage by Rnt1 (Figure 1D)(Henras et al., 2005). In fission yeast, Reb1 protein interacts with the
84 Rpa12 subunit of Pol I to stimulate termination (Jaiswal et al., 2016). In budding yeast, 90 % of Pol I
85 transcription termination occurs at a well-defined primary terminator element (T1) downstream of the
86 25S rRNA sequence (Figure 1D). Transcription termination at this site implicates the DNA-binding
87 factor Nsi1, a Reb1 paralog, which promotes termination upstream of T1 at a T-rich element that
88 likely operates as a polymerase release element (Lang and Reeder, 1993; Merkl et al., 2014; Reiter et
89 al., 2012). In 10% of the cases, Pol I reads through this first terminator and stops at a downstream,
90 “fail-safe” terminator (T2) located around position +250 from the 3’ end of the 25S rRNA sequence
91 (Reeder et al., 1999). Transcription termination on Pol II-transcribed genes was shown to involve the
92 5’-3’ exoribonuclease Rat1 through a mechanism called “torpedo” (West et al., 2004; Luo et al.,
93 2006; Kim et al., 2004). According to this model, Rat1 binds and degrades the transcript emerging
94 from the polymerase following cleavage and release of the pre-mRNA, and given its high
95 processivity, Rat1 catches up and dissociates Pol II from the DNA template. In the context of Pol I
96 transcription, Rat1 was shown to interact with terminator sequences T1 and T2 and to be required for
97 efficient termination. Its catalytic activity is required for this function since expression of a
98 catalytically inactive mutant of Rat1 (Rat1_{D235A}) could not suppress the Pol I termination defect
99 observed in absence of Rat1. The absence of both Rat1 and Fob1, bound to the Replication Fork
100 Barrier (RFB) site (Figure 1D), increases polymerase read-through of T2 and the RFB site, indicating
101 that Fob1 is also partly involved in termination (El Hage et al., 2008).

102 **Pol I subunits and trans-acting factors involved in elongation dynamics**

103 Transcription elongation properties involve in particular three Pol I subunits present on the
104 lobe (Figure 1B): Rpa12 and the heterodimer Rpa34/Rpa49 (Gadal et al., 1997; Nogi et al., 1993;
105 Liljelund et al., 1992). In absence of Rpa34/Rpa49, Pol I activity is altered (Huet et al., 1975;
106 Liljelund et al., 1992). Pol I lacking the Rpa34/Rpa49 subunits does not produce RNA to the same
107 extent as a wild-type enzyme (Kuhn et al., 2007; Beckouet et al., 2008; Albert et al., 2011).
108 Furthermore, this heterodimer plays an important role in transcription by improving the recruitment
109 of the Rrn3-Pol I complex to the rDNA and by triggering the release of Rrn3 from elongating Pol I.
110 Indeed, in an *rpa49* deletion strain, Rrn3 is recruited less efficiently at the promoter and fails to
111 dissociate from elongating polymerases following transcription initiation (Beckouet et al., 2008).
112 Interestingly, Rpa49 and Rpa34 are important for nucleolar assembly and formation of a property of
113 actively transcribed rRNA genes called “Pol I caravans” or “ Pol I convoys”, reflecting a spatial
114 proximity between adjacent polymerases (Albert et al., 2011; Neyer et al., 2016). Rpa12 subunit
115 stabilizes the Rpa49/Rpa34 heterodimer on the polymerase (Van Mullem et al., 2002; Tafur et al.,
116 2019). In the absence of Rpa12, Pol I catalytic properties are affected (Scull et al., 2021; Appling et
117 al., 2018). Furthermore, Pol I transcription through a linear mono-nucleosomal template was shown
118 to be defective in the absence of the lobe-binding subunits (Merkl et al., 2020). Mutations affecting
119 the Rpa135 subunit were also shown to affect transcription elongation. In particular, mutation of the
120 amino acid at position 784 (*rpa135-D784G*), suspected to play a role in loading NTP substrates,
121 caused reduced transcription compared to a wild-type Pol I. Calculation of Pol I elongation rate *in*
122 *vitro* showed that this Rpa135 mutant is ten times slower than the wild-type polymerase (Schneider et
123 al., 2007).

124 In addition to the role of Pol I subunits in transcription elongation, transcription factor Spt5 in
125 complex with Spt4, was also shown to be required for efficient Pol I transcription (Schneider et al.,
126 2006). Immunoprecipitation and mass spectrometry experiments showed that this complex interacts
127 directly with multiple Pol I subunits (Rpa49, Rpa34, Rpa135 and Rpa190), through the NGN and
128 KOW domains of Spt5 (Schneider et al., 2006). Moreover, Spt5 also associates with the transcription
129 factor Rrn3 and with the 35S rRNA gene (coding region and promoter) (Viktorovskaya et al., 2011).
130 Depletion of Spt4 in yeast results in a temperature-sensitive slow growth phenotype associated with a
131 decreased rRNA synthesis rate as well as a reduced Pol I elongation efficiency, also impacting pre-
132 rRNA processing and ribosome assembly (Schneider et al., 2006). Furthermore, Spt5 mutations
133 suppress the cold-sensitive phenotype of an *rpa49Δ* strain. All these data support a function of the
134 Spt4-Spt5 complex in Pol I transcription elongation, which remains to be understood at the molecular
135 level. Another related protein, Spt6, interacts with the Spt4/Spt5 complex and was also proposed to
136 play a role in Pol I transcription (Swanson and Winston, 1992). Spt6 interacts with Pol I subunit
137 Rpa43 (Beckouët et al., 2011). It was shown that Spt6 associates with rDNA and is required for Pol I
138 transcription since a strain carrying an in-frame deletion allele of *SPT6* (*Spt6-1004*) showed reduced
139 Pol I occupancy on the rDNA (Engel et al., 2015). Other factors including Hmo1 also modulate Pol I
140 elongation properties, but the underlying mechanisms remain elusive (Higashino et al., 2015; Albert
141 et al., 2013).

142 **Mapping Pol I position at nucleotide resolution to investigate Pol I elongation *in vivo***

143 In addition to the implication of Pol I subunits and trans-acting factors, Pol I elongation is
144 also regulated by mechanisms intrinsic to the transcription process. Elongation is fundamentally
145 discontinuous, with events of pausing, backtracking and possible premature termination, which
146 remain to be explored. Pol I elongation was studied using the native elongating transcript sequencing
147 (NET-seq) method, based on deep sequencing of the 3' ends of nascent transcripts associated with
148 the polymerase (Churchman and Weissman, 2011). This study revealed hundreds of positions within
149 rDNA that reproducibly induce pausing (Clarke et al., 2018). Unfortunately, fragments of mature
150 rRNAs co-purifying with Pol I in the NET-seq procedure could introduce bias in the analysis.
151 Turowski and co-workers used the crosslinking and analysis of cDNAs (CRAC) technique to map the
152 position of Pol I on rDNA during elongation. CRAC consists in crosslinking Pol I to its associated
153 nascent rRNAs during elongation *in vivo*, followed by complex purification, reverse transcription of
154 associated rRNAs and sequencing of cDNAs (Turowski et al., 2020). Applied to a population of
155 cells, this method provides a statistical snapshot of the position of transcribing Pol I all along the
156 rDNA unit and allows the determination of areas of the gene in which Pol I is accumulated (Figure
157 2A). It is noteworthy that a high polymerase occupancy reflects a low elongation rate. This CRAC
158 analysis revealed a massive Pol I enrichment in the 5' end of rRNA genes. Enrichment of
159 polymerases at the 5' end of rRNA genes was previously observed, but to a much lower extent,
160 using the chromatin spread method developed by Oskar Miller, allowing a direct observation of Pol I
161 in complex along rDNA (Miller and Beatty, 1969)(Osheim et al., 2009; French et al., 2003). It was
162 speculated that the high density of polymerases in the 5'ETS region, called "Low Entrainment
163 Region" (LER), results in polymerases moving more slowly (decreasing Pol I elongation rate <20%)
164 and more closely positioned over the initial 2 kb. As an underlying mechanism, Turowski and
165 collaborators proposed that in the LER, where Pol I is associated with only short nascent transcripts,
166 Pol I molecules are able to rotate freely along DNA grooves during elongation, while they become
167 progressively unable to do so due to viscous drag 2 Kb after initiation (Figure 2B). Accordingly,
168 polymerase activity in the LER would not generate torsion in DNA, which allows changes in the
169 relative positions of adjacent polymerases. This results in increased freedom for movement, likely
170 increasing the probability of backtracking events, which would explain the accumulation of Pol I in

Running Title: co-transcriptional folding of ribosomal RNA

171 the 5' region of the genes. The high density of polymerases in the 5'ETS region is also correlated
172 with the fact that major early pre-rRNA assembly events take place on the 5' region of nascent rRNA
173 (Chaker-Margot et al., 2017).

174 It is important to note that Pol I translocation is based on Brownian ratchet motion making
175 elongation prone to frequent backtracking and potentially sensitive to quite modest forces
176 (Dangkulwanich et al., 2013). Co-transcriptional folding of the nascent rRNA has direct
177 consequences on elongation by preventing backtracking, thereby favoring productive elongation
178 (Turowski et al., 2020). Any co-transcriptional association with the nascent transcript of trans-acting
179 factors (UTPs, snoRNPs) should have the same stimulatory effect on transcription. With up to 200
180 transcribing Pol I per rRNA gene, each enzyme is influenced by its neighbors along the template
181 directly through steric constraints. Indirectly, away of the LER predicted to occur only in the first 2
182 kb, torsional constraints on DNA plays a major role (torsional coupling):

183 - When the rotation around DNA of the transcribing polymerases is prevented by viscous drag
184 due to the size and structure of nascent rRNA, elongation can be described within the twin-
185 supercoiled domain model: DNA screws into the polymerase and experiences positive supercoiling
186 downstream and negative supercoiling upstream (Liu and Wang, 1987).

187 - When all polymerases transcribe at the same rate, the negative DNA supercoiling created in
188 the wake of one translocating polymerase is rapidly cancelled out by the positive DNA supercoiling
189 created in front of the following one. The torsional stress between polymerases is alleviated and a fast
190 and processive collective translocation is allowed, leading to polymerase convoys (Lesne et al., 2018;
191 Kim et al., 2019). Therefore, all polymerases in convoys translocate at the same rate, their spacing
192 remains constant (Figure 2C). Any change in the relative positions of transcribing polymerases
193 generates torsional stress, which will quickly exceed the low stalling force of the polymerases
194 (Heberling et al., 2016; Ma et al., 2013; Tantale et al., 2016). Any local modification of Pol I spacing
195 within rDNA modifies DNA supercoiling, and the associated increase of local torsional energy
196 generates an apparent force sufficiently strong to restore the initial distance between the polymerases
197 and ensures the cohesion of the convoy (Lesne et al., 2018). Deletion or rapid depletion of
198 topoisomerase I, results in defective rRNA synthesis (Albert et al., 2019; El Hage et al., 2010),
199 highlighting the importance of resolving DNA supercoiling (downstream and upstream of each
200 convoy) for efficient Pol I transcription elongation.

201 However, this cooperative long-distance group behavior may also induce antagonist effects on
202 elongation. It was observed that promoter shut-off reduces the apparent elongation rate of the
203 engaged polymerases, which is associated with a significant increase in premature termination (Kim
204 et al., 2019). It is rational to suppose that the same effect occurs when elongating Pol I gets stalled on
205 rDNA, thus leading to accumulation of negative torsional stress in the wake of the downstream Pol I
206 (*i.e.* the nearby Pol I farthest from the promoter). Pol I stalling is known to increase premature
207 termination of the paused Pol I and possibly also of the downstream polymerases (Figure 2C). Such a
208 phenomenon was previously described as premature termination of transcription (PTT) for Pol II
209 (Kamieniarz-Gdula and Proudfoot, 2019).

210 These premature termination events could also potentially explain the 5' bias observed in the
211 Pol I CRAC profile. Pol II is known to undergo a transition from initiation to elongation states that is
212 associated with changes of the phosphorylation status of the C-terminal domain (CTD) of the largest
213 Pol II subunit (Milligan et al., 2016). It is possible that Pol I undergoes a similar transition, the 5'
214 accumulation bias reflecting a region in which the polymerase has an elevated probability to

215 terminate prematurely. However, consideration of premature termination in the model of Turowski
216 and collaborators, even though it recapitulated the overall profile, reduced by 30% the total number
217 of polymerases per transcription unit, which falls below the number of Pol I molecules per rDNA
218 observed using Miller spreads (Turowski et al., 2020). Nevertheless, premature termination of Pol I
219 cannot be excluded and could, at least partially, play a role in establishing the 5' bias.

220 **Working hypothesis: Pol I processivity and premature termination**

221 In order to better understand transcription regulation, Pol I mutants are of particular interest.
222 We have recently identified in a genetic screen a super-active Pol I mutant, bearing a single
223 substitution on the second largest subunit: Rpa135-F301S allele, hereafter named SuperPol I. This
224 mutant induces an increase of rRNA production in yeast (Darrière et al., 2019). The mechanism
225 leading to this increased rRNA production is not well understood. We proposed that this mutation
226 alleviates an intrinsic repressive element of the polymerase, leading to increased processivity during
227 elongation, *i.e.* the ability of Pol I to carry out continuous RNA synthesis on the DNA template
228 without premature termination. This hypothesis is based on several experimental evidences. First,
229 Miller spreads showed that the amounts of Pol I engaged in transcription are comparable in wild-type
230 (WT) and mutant cells, meaning that the increased production of rRNA is not due to a major
231 enhancement of Pol I initiation rate (Darrière et al., 2019). Moreover, *in vitro* promoter-dependent
232 transcription assays confirmed that transcription initiation rate is similar between WT and SuperPol I.
233 On the other hand, a tailed template assay, measuring elongation rate *in vitro*, revealed an increased
234 rRNA production by the SuperPol I, likely due to a higher processivity (Darrière et al., 2019). Taken
235 together, these elements suggest that the Rpa135-F301S mutation induces modifications in the
236 elongation process, and more precisely on processivity. Premature termination directly affects
237 processivity and likely influences Pol I distribution along the DNA template. Importantly, premature
238 termination can not be measured by CRAC, which relies on detection of rRNA still bound to Pol I.
239 To demonstrate the occurrence of premature termination events, defined as a dissociation of the
240 elongation complex and release of the nascent rRNA, it will be necessary to correlate Pol I complex
241 stalling with the production of abortive rRNAs. This could be achieved by combining Pol I CRAC
242 data, highlighting precise pause sites, with a mapping of the corresponding abortive transcripts.
243 Detection of rRNA species resulting from abortive transcription in differential amounts in cells
244 expressing the SuperPol or WT polymerase should allow to better understand what features of
245 elongating Pol I lead to premature termination. The increased processivity of the SuperPol mutant
246 could likely be the consequence of a lower occurrence of premature termination, *i.e.* a lower
247 production of abortive rRNAs.

248 **Conclusion and perspectives**

249 Methods allowing to map at nucleotide resolution Pol I pausing sites during elongation
250 revealed a key interplay between RNA folding and elongation rate: formation of rRNA secondary
251 structure prevents backtracking, hence enhances elongation rate. With a large amount of co-
252 transcriptional folding of rRNA, we are now able to study how processing events are affecting Pol I
253 elongation rate. So far limited to budding yeast, there is no doubt that some Pol I regulatory
254 mechanism are evolutionary conserved, as Pol I elongation rate is limiting for rRNA synthesis in
255 metazoan cells (Hung et al., 2017). The understanding of the precise mechanistic of Pol I
256 transcription and the implication of each inherent elongation feature opens wide prospects on health-
257 related areas of research, particularly to understand a large number of genetic diseases collectively
258 called ribosomopathies. Pol I inhibition used in cancer therapy these recent years will also benefit
259 from such mechanistic breakthroughs (Ferreira et al., 2020; Kampen et al., 2020; Sulima et al., 2019).

A

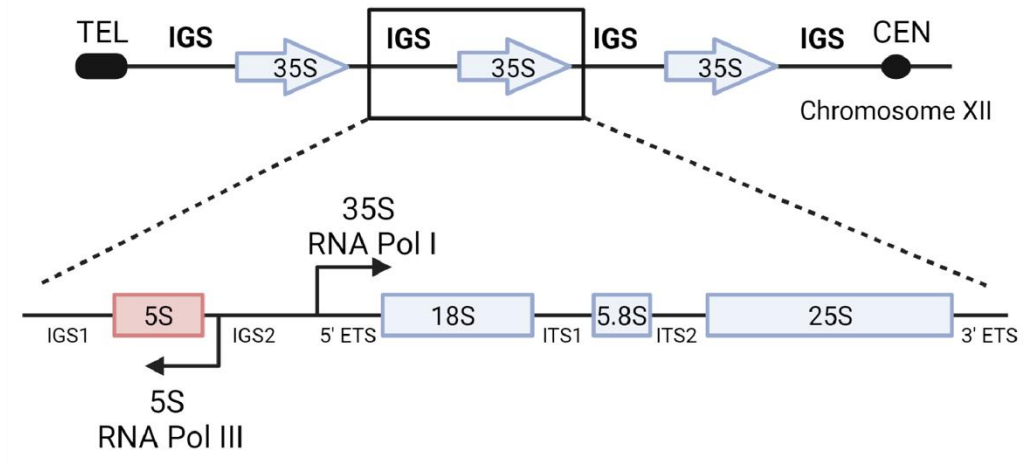

B

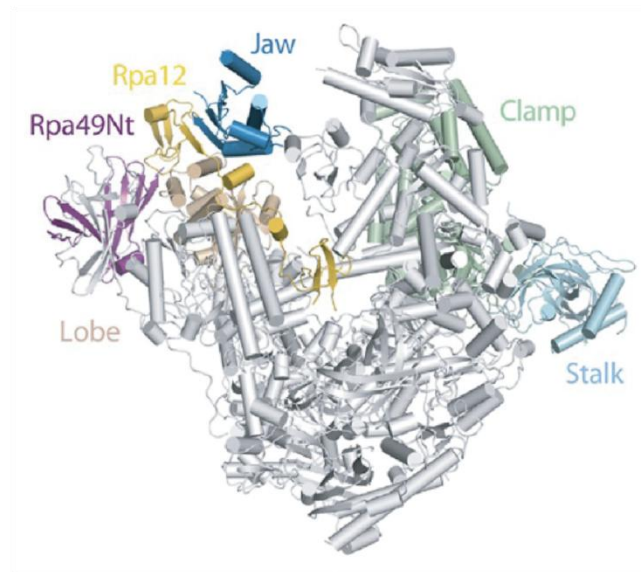

C

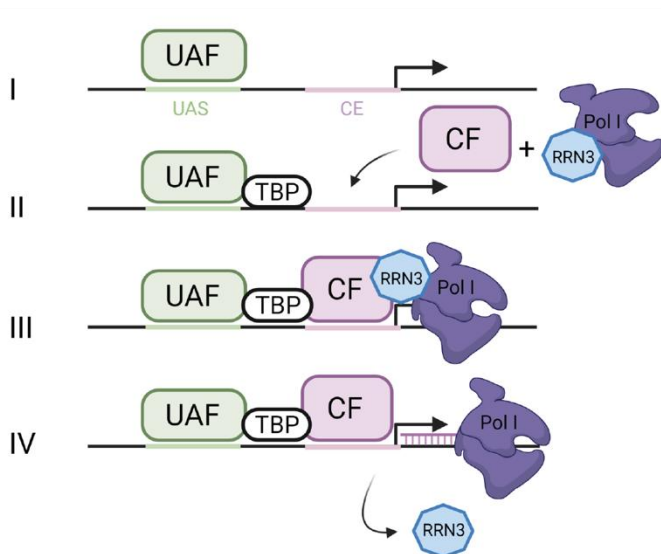

D

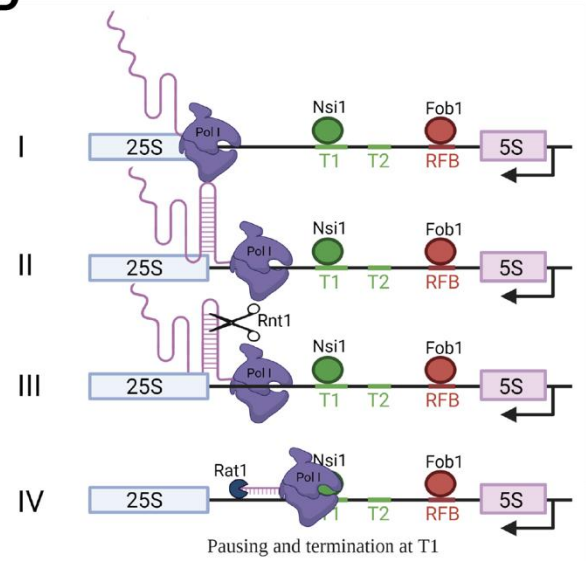

262 **Figure 1: Ribosomal DNA transcription by RNA Pol I**

263 **A. Ribosomal DNA.** The rDNA repeats (150-200) are located on chromosome XII. A single
264 repeated unit is transcribed by RNA polymerase I (Pol I) to synthesize the 35S primary pre-rRNA
265 transcript, which is then processed to produce the mature 18S, 5,8S and 25S rRNAs (arrow pointing
266 to the right). RNA Polymerase III synthesizes the 5S rRNA (arrow pointing to the left). IGS,
267 intergenic sequences; ETS, external transcribed spacer; ITS, internal transcribed spacer.

268 **B. RNA Polymerase I.** Pol I 3D structure (Darrière et al., 2019). View of the initially
269 transcribing complex model and its 4 different subunits - PDB 5W66 (Han et al., 2017). Catalytic
270 amino acids are located in the center of the central cleft. The two main modules are mobile and allow
271 cleft opening and closure, depending of the transcription step.

272 **C. Transcription initiation.** Composition of Pol I pre-initiation complex (see text for
273 details). UAF, Upstream Activating Factor; TBP, TATA-binding protein; CF, Core Factor.

274 **D. Transcription termination.** Pol I termination mechanisms (see text for details).

A

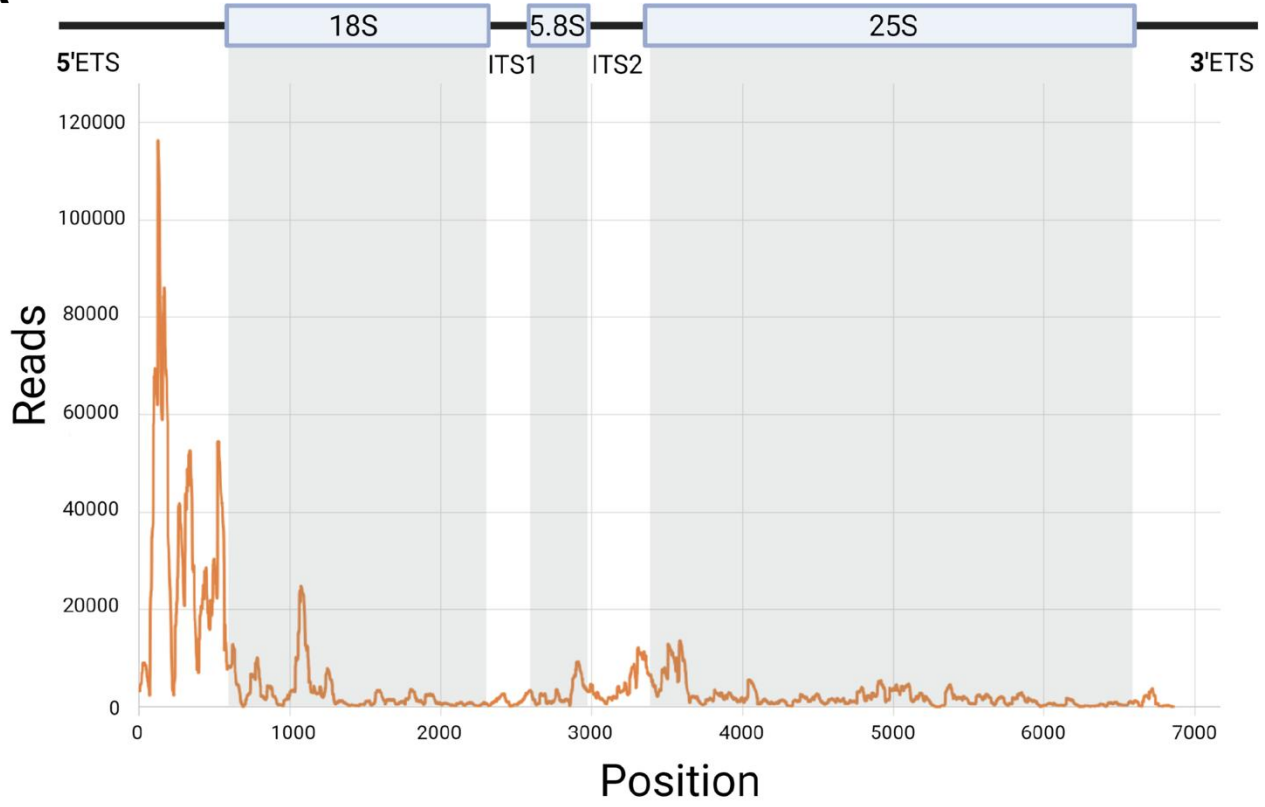

B

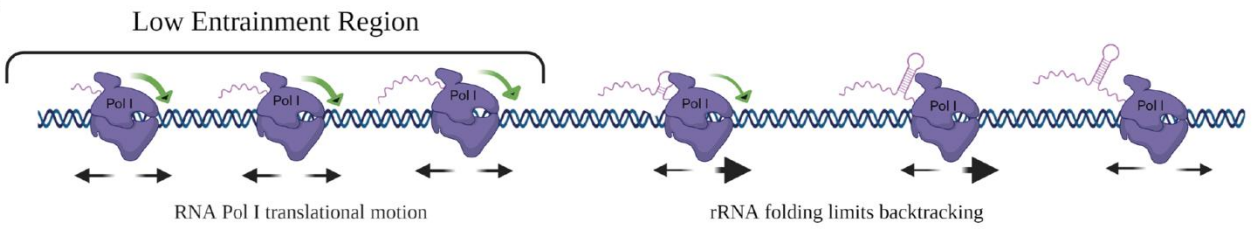

C

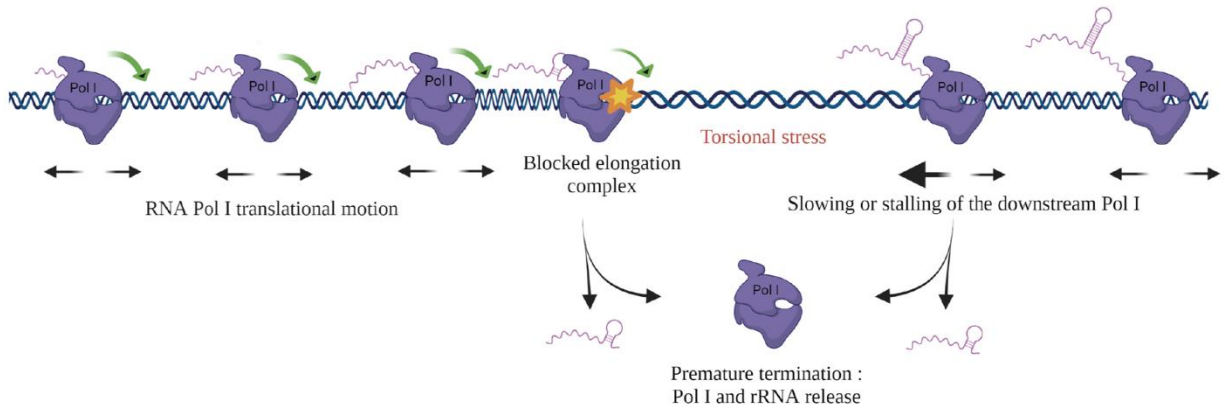

275

276

277 **Figure 2: RNA Pol I elongation dynamics**

278 **A. RNA Pol I distribution along rDNA template.** Rpa135-CRAC results showing strong
279 Pol I accumulation at 5' end of the rRNA gene (Turowski et al., 2020).

280 **B. Elongation dynamics in the Low Entrainment Region.** Schematic representation of Pol
281 I elongation dynamics in the LER (Turowski et al., 2020). Associated with short nascent transcripts,
282 Pol I can easily rotate around rDNA in the 5' region, leading to free translocation and a higher rate of
283 backtracking. Beyond LER, viscous drag limits the rotation of the pre-RNA/Pol I complex around
284 DNA.

285 **C. Premature termination.** Model including the propensity of the elongation complex to
286 dissociate and release rRNA, leading to premature termination. When a Pol I is stalled, a torsional
287 stress occurs that could be resolved by a premature transcription termination (PTT) event.

288

289 **Conflict of Interest**

290 The authors declare that the research was conducted in the absence of any commercial or
291 financial relationships that could be construed as a potential conflict of interest.

292 **Author Contributions**

293 OG and AKH conceived the manuscript. CA and MJ wrote the manuscript. All authors
294 contributed to the article and approved the submitted version.

295 **Funding**

296 OG has been supported by the “Fondation ARC pour la Recherche sur le Cancer”, by the
297 “Ligue contre le cancer”, and by the “Centre de Biologie Integrative (CBI)” grant. CA benefited from
298 PhD fellowship from “La Ligue contre le Cancer”. AKH has been supported by ANR grant
299 “CHROMRIB” (ANR-16-CE12-0027-01).

300 **Acknowledgments**

301 We would like to thank all of members of Gadal and Henry-Henras groups for helpful
302 discussions.

303

304 **References**

- 305 Albert, B., Colleran, C., Léger-Silvestre, I., Berger, A. B., Dez, C., Normand, C., Perez-Fernandez,
306 J., McStay, B., and Gadal, O. (2013). Structure-function analysis of Hmo1 unveils an
307 ancestral organization of HMG-Box factors involved in ribosomal DNA transcription from
308 yeast to human. *Nucleic Acids Res.* 41, 10135–10149. doi:10.1093/nar/gkt770.
- 309 Albert, B., Kos-Braun, I. C., Henras, A. K., Dez, C., Rueda, M. P., Zhang, X., Gadal, O., Kos, M.,
310 and Shore, D. (2019). A ribosome assembly stress response regulates transcription to
311 maintain proteome homeostasis. *BioRxiv*. doi:10.1101/512665.
- 312 Albert, B., Léger-Silvestre, I., Normand, C., Ostermaier, M. K., Pérez-Fernández, J., Panov, K. I.,
313 Zomerdijk, J. C. B. M., Schultz, P., and Gadal, O. (2011). RNA polymerase I-specific
314 subunits promote polymerase clustering to enhance the rRNA gene transcription cycle. *J. Cell*
315 *Biol.* 192, 277–293. doi:10.1083/jcb.201006040.
- 316 Appling, F. D., Scull, C. E., Lucius, A. L., and Schneider, D. A. (2018). The A12.2 subunit is an
317 intrinsic destabilizer of the RNA polymerase I elongation complex. *Biophys. J.* 114, 2507–
318 2515. doi:10.1016/j.bpj.2018.04.015.
- 319 Aprikian, P., Moorefield, B., and Reeder, R. H. (2001). New model for the yeast RNA polymerase I
320 transcription cycle. *Mol. Cell. Biol.* 21, 4847–4855. doi:10.1128/MCB.21.15.4847-
321 4855.2001.
- 322 Beckouet, F., Labarre-Mariotte, S., Albert, B., Imazawa, Y., Werner, M., Gadal, O., Nogi, Y., and
323 Thuriaux, P. (2008). Two RNA polymerase I subunits control the binding and release of Rrn3
324 during transcription. *Mol. Cell. Biol.* 28, 1596–1605. doi:10.1128/MCB.01464-07.
- 325 Beckouët, F., Mariotte-Labarre, S., Peyroche, G., Nogi, Y., and Thuriaux, P. (2011). Rpa43 and its
326 partners in the yeast RNA polymerase I transcription complex. *FEBS Lett.* 585, 3355–3359.
327 doi:10.1016/j.febslet.2011.09.011.
- 328 Blattner, C., Jennebach, S., Herzog, F., Mayer, A., Cheung, A. C. M., Witte, G., Lorenzen, K.,
329 Hopfner, K.-P., Heck, A. J. R., Aebersold, R., et al. (2011). Molecular basis of Rrn3-regulated
330 RNA polymerase I initiation and cell growth. *Genes Dev.* 25, 2093–2105.
331 doi:10.1101/gad.17363311.
- 332 Boukhgalter, B., Liu, M., Guo, A., Tripp, M., Tran, K., Huynh, C., and Pape, L. (2002).
333 Characterization of a fission yeast subunit of an RNA polymerase I essential transcription
334 initiation factor, SpRrn7h/TAF(I)68, that bridges yeast and mammals: association with
335 SpRrn11h and the core ribosomal RNA gene promoter. *Gene* 291, 187–201.
336 doi:10.1016/s0378-1119(02)00597-8.
- 337 Chaker-Margot, M., Barandun, J., Hunziker, M., and Klinge, S. (2017). Architecture of the yeast
338 small subunit processome. *Science* 355. doi:10.1126/science.aal1880.
- 339 Churchman, L. S., and Weissman, J. S. (2011). Nascent transcript sequencing visualizes transcription
340 at nucleotide resolution. *Nature* 469, 368–373. doi:10.1038/nature09652.
- 341 Clarke, A. M., Engel, K. L., Giles, K. E., Petit, C. M., and Schneider, D. A. (2018). NETSeq reveals

- 342 heterogeneous nucleotide incorporation by RNA polymerase I. *Proc. Natl. Acad. Sci. USA*
343 115, E11633–E11641. doi:10.1073/pnas.1809421115.
- 344 Dangkulwanich, M., Ishibashi, T., Liu, S., Kireeva, M. L., Lubkowska, L., Kashlev, M., and
345 Bustamante, C. J. (2013). Complete dissection of transcription elongation reveals slow
346 translocation of RNA polymerase II in a linear ratchet mechanism. *Elife* 2, e00971.
347 doi:10.7554/eLife.00971.
- 348 Darrière, T., Pilsl, M., Sarthou, M.-K., Chauvier, A., Genty, T., Audibert, S., Dez, C., Léger-
349 Silvestre, I., Normand, C., Henras, A. K., et al. (2019). Genetic analyses led to the discovery
350 of a super-active mutant of the RNA polymerase I. *PLoS Genet.* 15, e1008157.
351 doi:10.1371/journal.pgen.1008157.
- 352 El Hage, A., French, S. L., Beyer, A. L., and Tollervey, D. (2010). Loss of Topoisomerase I leads to
353 R-loop-mediated transcriptional blocks during ribosomal RNA synthesis. *Genes Dev.* 24,
354 1546–1558. doi:10.1101/gad.573310.
- 355 El Hage, A., Koper, M., Kufel, J., and Tollervey, D. (2008). Efficient termination of transcription by
356 RNA polymerase I requires the 5' exonuclease Rat1 in yeast. *Genes Dev.* 22, 1069–1081.
357 doi:10.1101/gad.463708.
- 358 Engel, C., Plitzko, J., and Cramer, P. (2016). RNA polymerase I-Rrn3 complex at 4.8 Å resolution.
359 *Nat. Commun.* 7, 12129. doi:10.1038/ncomms12129.
- 360 Engel, C., Sainsbury, S., Cheung, A. C., Kostrewa, D., and Cramer, P. (2013). RNA polymerase I
361 structure and transcription regulation. *Nature* 502, 650–655. doi:10.1038/nature12712.
- 362 Engel, K. L., French, S. L., Viktorovskaya, O. V., Beyer, A. L., and Schneider, D. A. (2015). Spt6 Is
363 Essential for rRNA Synthesis by RNA Polymerase I. *Mol. Cell. Biol.* 35, 2321–2331.
364 doi:10.1128/MCB.01499-14.
- 365 Fernández-Tornero, C., Moreno-Morcillo, M., Rashid, U. J., Taylor, N. M. I., Ruiz, F. M., Gruene,
366 T., Legrand, P., Steuerwald, U., and Müller, C. W. (2013). Crystal structure of the 14-subunit
367 RNA polymerase I. *Nature* 502, 644–649. doi:10.1038/nature12636.
- 368 Ferreira, R., Schneekloth, J. S., Panov, K. I., Hannan, K. M., and Hannan, R. D. (2020). Targeting the
369 RNA polymerase I transcription for cancer therapy comes of age. *Cells* 9.
370 doi:10.3390/cells9020266.
- 371 French, S. L., Osheim, Y. N., Cioci, F., Nomura, M., and Beyer, A. L. (2003). In exponentially
372 growing *Saccharomyces cerevisiae* cells, rRNA synthesis is determined by the summed RNA
373 polymerase I loading rate rather than by the number of active genes. *Mol. Cell. Biol.* 23,
374 1558–1568. doi:10.1128/mcb.23.5.1558-1568.2003.
- 375 Gadai, O., Mariotte-Labarre, S., Chedin, S., Quemeneur, E., Carles, C., Sentenac, A., and Thuriaux,
376 P. (1997). A34.5, a nonessential component of yeast RNA polymerase I, cooperates with
377 subunit A14 and DNA topoisomerase I to produce a functional rRNA synthesis machine.
378 *Mol. Cell. Biol.* 17, 1787–1795. doi:10.1128/mcb.17.4.1787.
- 379 Han, Y., Yan, C., Nguyen, T. H. D., Jackobel, A. J., Ivanov, I., Knutson, B. A., and He, Y. (2017).

Running Title: co-transcriptional folding of ribosomal RNA

- 380 Structural mechanism of ATP-independent transcription initiation by RNA polymerase I.
381 *Elife* 6. doi:10.7554/eLife.27414.
- 382 Heberling, T., Davis, L., Gedeon, J., Morgan, C., and Gedeon, T. (2016). A Mechanistic Model for
383 Cooperative Behavior of Co-transcribing RNA Polymerases. *PLoS Comput. Biol.* 12,
384 e1005069. doi:10.1371/journal.pcbi.1005069.
- 385 Henras, A. K., Sam, M., Hiley, S. L., Wu, H., Hughes, T. R., Feigon, J., and Chanfreau, G. F. (2005).
386 Biochemical and genomic analysis of substrate recognition by the double-stranded RNA
387 binding domain of yeast RNase III. *RNA* 11, 1225–1237. doi:10.1261/rna.2760705.
- 388 Higashino, A., Shiwa, Y., Yoshikawa, H., Kokubo, T., and Kasahara, K. (2015). Both HMG boxes in
389 Hmo1 are essential for DNA binding in vitro and in vivo. *Biosci. Biotechnol. Biochem.* 79,
390 384–393. doi:10.1080/09168451.2014.978258.
- 391 Huet, J., Buhler, J. M., Sentenac, A., and Fromageot, P. (1975). Dissociation of two polypeptide
392 chains from yeast RNA polymerase A. *Proc. Natl. Acad. Sci. USA* 72, 3034–3038.
393 doi:10.1073/pnas.72.8.3034.
- 394 Hung, S. S., Lesmana, A., Peck, A., Lee, R., Tchoubrieva, E., Hannan, K. M., Lin, J., Sheppard, K.
395 E., Jastrzebski, K., Quinn, L. M., et al. (2017). Cell cycle and growth stimuli regulate
396 different steps of RNA polymerase I transcription. *Gene* 612, 36–48.
397 doi:10.1016/j.gene.2016.12.015.
- 398 Jaiswal, R., Choudhury, M., Zaman, S., Singh, S., Santosh, V., Bastia, D., and Escalante, C. R.
399 (2016). Functional architecture of the Reb1-Ter complex of *Schizosaccharomyces pombe*.
400 *Proc. Natl. Acad. Sci. USA* 113, E2267–76. doi:10.1073/pnas.1525465113.
- 401 Kamieniarz-Gdula, K., and Proudfoot, N. J. (2019). Transcriptional control by premature
402 termination: A forgotten mechanism. *Trends Genet.* 35, 553–564.
403 doi:10.1016/j.tig.2019.05.005.
- 404 Kampen, K. R., Sulima, S. O., Vereecke, S., and De Keersmaecker, K. (2020). Hallmarks of
405 ribosomopathies. *Nucleic Acids Res.* 48, 1013–1028. doi:10.1093/nar/gkz637.
- 406 Keener, J., Josaitis, C. A., Dodd, J. A., and Nomura, M. (1998). Reconstitution of yeast RNA
407 polymerase I transcription in vitro from purified components. TATA-binding protein is not
408 required for basal transcription. *J. Biol. Chem.* 273, 33795–33802.
409 doi:10.1074/jbc.273.50.33795.
- 410 Kim, M., Ahn, S.-H., Krogan, N. J., Greenblatt, J. F., and Buratowski, S. (2004). Transitions in RNA
411 polymerase II elongation complexes at the 3' ends of genes. *EMBO J.* 23, 354–364.
412 doi:10.1038/sj.emboj.7600053.
- 413 Kim, S., Beltran, B., Irnov, I., and Jacobs-Wagner, C. (2019). Long-Distance Cooperative and
414 Antagonistic RNA Polymerase Dynamics via DNA Supercoiling. *Cell* 179, 106–119.e16.
415 doi:10.1016/j.cell.2019.08.033.
- 416 Knutson, B. A., Smith, M. L., Belkevich, A. E., and Fakhouri, A. M. (2020). Molecular topology of
417 RNA polymerase I upstream activation factor. *Mol. Cell. Biol.* 40. doi:10.1128/MCB.00056-

- 418 20.
- 419 Kuhn, C.-D., Geiger, S. R., Baumli, S., Gartmann, M., Gerber, J., Jennebach, S., Mielke, T.,
420 Tschochner, H., Beckmann, R., and Cramer, P. (2007). Functional architecture of RNA
421 polymerase I. *Cell* 131, 1260–1272. doi:10.1016/j.cell.2007.10.051.
- 422 Lang, W. H., and Reeder, R. H. (1993). The REB1 site is an essential component of a terminator for
423 RNA polymerase I in *Saccharomyces cerevisiae*. *Mol. Cell. Biol.* 13, 649–658.
424 doi:10.1128/mcb.13.1.649.
- 425 Lesne, A., Victor, J.-M., Bertrand, E., Basyuk, E., and Barbi, M. (2018). The role of supercoiling in
426 the motor activity of RNA polymerases. *Methods Mol. Biol.* 1805, 215–232. doi:10.1007/978-
427 1-4939-8556-2_11.
- 428 Liljelund, P., Mariotte, S., Buhler, J. M., and Sentenac, A. (1992). Characterization and mutagenesis
429 of the gene encoding the A49 subunit of RNA polymerase A in *Saccharomyces cerevisiae*.
430 *Proc. Natl. Acad. Sci. USA* 89, 9302–9305. doi:10.1073/pnas.89.19.9302.
- 431 Liu, L. F., and Wang, J. C. (1987). Supercoiling of the DNA template during transcription. *Proc.*
432 *Natl. Acad. Sci. USA* 84, 7024–7027. doi:10.1073/pnas.84.20.7024.
- 433 Luo, W., Johnson, A. W., and Bentley, D. L. (2006). The role of Rat1 in coupling mRNA 3'-end
434 processing to transcription termination: implications for a unified allosteric-torpedo model.
435 *Genes Dev.* 20, 954–965. doi:10.1101/gad.1409106.
- 436 Ma, J., Bai, L., and Wang, M. D. (2013). Transcription under torsion. *Science* 340, 1580–1583.
437 doi:10.1126/science.1235441.
- 438 Merkl, P. E., Pilsl, M., Fremter, T., Schwank, K., Engel, C., Längst, G., Milkereit, P., Griesenbeck,
439 J., and Tschochner, H. (2020). RNA polymerase I (Pol I) passage through nucleosomes
440 depends on Pol I subunits binding its lobe structure. *J. Biol. Chem.* 295, 4782–4795.
441 doi:10.1074/jbc.RA119.011827.
- 442 Merkl, P., Perez-Fernandez, J., Pilsl, M., Reiter, A., Williams, L., Gerber, J., Böhm, M., Deutzmann,
443 R., Griesenbeck, J., Milkereit, P., et al. (2014). Binding of the termination factor Nsi1 to its
444 cognate DNA site is sufficient to terminate RNA polymerase I transcription in vitro and to
445 induce termination in vivo. *Mol. Cell. Biol.* 34, 3817–3827. doi:10.1128/MCB.00395-14.
- 446 Miller, O. L., and Beatty, B. R. (1969). Visualization of nucleolar genes. *Science* 164, 955–957.
447 doi:10.1126/science.164.3882.955.
- 448 Milligan, L., Huynh-Thu, V. A., Delan-Forino, C., Tuck, A., Petfalski, E., Lombraña, R., Sanguinetti,
449 G., Kudla, G., and Tollervy, D. (2016). Strand-specific, high-resolution mapping of modified
450 RNA polymerase II. *Mol. Syst. Biol.* 12, 874. doi:10.15252/msb.20166869.
- 451 Moreno-Morcillo, M., Taylor, N. M. I., Gruene, T., Legrand, P., Rashid, U. J., Ruiz, F. M.,
452 Steuerwald, U., Müller, C. W., and Fernández-Tornero, C. (2014). Solving the RNA
453 polymerase I structural puzzle. *Acta Crystallogr. Sect. D, Biol. Crystallogr.* 70, 2570–2582.
454 doi:10.1107/S1399004714015788.

Running Title: co-transcriptional folding of ribosomal RNA

- 455 Neyer, S., Kunz, M., Geiss, C., Hantsche, M., Hodirnau, V.-V., Seybert, A., Engel, C., Scheffer, M.
456 P., Cramer, P., and Frangakis, A. S. (2016). Structure of RNA polymerase I transcribing
457 ribosomal DNA genes. *Nature* 540, 607–610. doi:10.1038/nature20561.
- 458 Nogi, Y., Yano, R., Dodd, J., Carles, C., and Nomura, M. (1993). Gene RRN4 in *Saccharomyces*
459 *cerevisiae* encodes the A12.2 subunit of RNA polymerase I and is essential only at high
460 temperatures. *Mol. Cell. Biol.* 13, 114–122. doi:10.1128/mcb.13.1.114.
- 461 Nomura, M. (2001). Ribosomal RNA genes, RNA polymerases, nucleolar structures, and synthesis of
462 rRNA in the yeast *Saccharomyces cerevisiae*. *Cold Spring Harb. Symp. Quant. Biol.* 66, 555–
463 565. doi:10.1101/sqb.2001.66.555.
- 464 Osheim, Y. N., French, S. L., Sikes, M. L., and Beyer, A. L. (2009). Electron microscope
465 visualization of RNA transcription and processing in *Saccharomyces cerevisiae* by Miller
466 chromatin spreading. *Methods Mol. Biol.* 464, 55–69. doi:10.1007/978-1-60327-461-6_4.
- 467 Peyroche, G., Milkereit, P., Bischler, N., Tschochner, H., Schultz, P., Sentenac, A., Carles, C., and
468 Riva, M. (2000). The recruitment of RNA polymerase I on rDNA is mediated by the
469 interaction of the A43 subunit with Rrn3. *EMBO J.* 19, 5473–5482.
470 doi:10.1093/emboj/19.20.5473.
- 471 Reeder, R. H., Guevara, P., and Roan, J. G. (1999). *Saccharomyces cerevisiae* RNA polymerase I
472 terminates transcription at the Reb1 terminator in vivo. *Mol. Cell. Biol.* 19, 7369–7376.
473 doi:10.1128/mcb.19.11.7369.
- 474 Reiter, A., Hamperl, S., Seitz, H., Merkl, P., Perez-Fernandez, J., Williams, L., Gerber, J., Németh,
475 A., Léger, I., Gadai, O., et al. (2012). The Reb1-homologue Ydr026c/Nsi1 is required for
476 efficient RNA polymerase I termination in yeast. *EMBO J.* 31, 3480–3493.
477 doi:10.1038/emboj.2012.185.
- 478 Riva, M., Schäffner, A. R., Sentenac, A., Hartmann, G. R., Mustaev, A. A., Zaychikov, E. F., and
479 Grachev, M. A. (1987). Active site labeling of the RNA polymerases A, B, and C from yeast.
480 *J. Biol. Chem.* 262, 14377–14380.
- 481 Sadian, Y., Baudin, F., Tafur, L., Murciano, B., Wetzels, R., Weis, F., and Müller, C. W. (2019).
482 Molecular insight into RNA polymerase I promoter recognition and promoter melting. *Nat.*
483 *Commun.* 10, 5543. doi:10.1038/s41467-019-13510-w.
- 484 Sadian, Y., Tafur, L., Kosinski, J., Jakobi, A. J., Wetzels, R., Buczak, K., Hagen, W. J., Beck, M.,
485 Sachse, C., and Müller, C. W. (2017). Structural insights into transcription initiation by yeast
486 RNA polymerase I. *EMBO J.* 36, 2698–2709. doi:10.15252/embj.201796958.
- 487 Schneider, D. A., French, S. L., Osheim, Y. N., Bailey, A. O., Vu, L., Dodd, J., Yates, J. R., Beyer,
488 A. L., and Nomura, M. (2006). RNA polymerase II elongation factors Spt4p and Spt5p play
489 roles in transcription elongation by RNA polymerase I and rRNA processing. *Proc. Natl.*
490 *Acad. Sci. USA* 103, 12707–12712. doi:10.1073/pnas.0605686103.
- 491 Schneider, D. A., Michel, A., Sikes, M. L., Vu, L., Dodd, J. A., Salgia, S., Osheim, Y. N., Beyer, A.
492 L., and Nomura, M. (2007). Transcription elongation by RNA polymerase I is linked to
493 efficient rRNA processing and ribosome assembly. *Mol. Cell* 26, 217–229.

- 494 doi:10.1016/j.molcel.2007.04.007.
- 495 Scull, C. E., Lucius, A. L., and Schneider, D. A. (2021). The N-terminal domain of the A12.2 subunit
496 stimulates RNA polymerase I transcription elongation. *Biophys. J.*
497 doi:10.1016/j.bpj.2021.03.007.
- 498 Smith, M. L., Cui, W., Jackobel, A. J., Walker-Kopp, N., and Knutson, B. A. (2018). Reconstitution
499 of RNA polymerase I upstream activating factor and the roles of histones H3 and H4 in
500 complex assembly. *J. Mol. Biol.* 430, 641–654. doi:10.1016/j.jmb.2018.01.003.
- 501 Steffan, J. S., Keys, D. A., Dodd, J. A., and Nomura, M. (1996). The role of TBP in rDNA
502 transcription by RNA polymerase I in *Saccharomyces cerevisiae*: TBP is required for
503 upstream activation factor-dependent recruitment of core factor. *Genes Dev.* 10, 2551–2563.
504 doi:10.1101/gad.10.20.2551.
- 505 Sulima, S. O., Kampen, K. R., and De Keersmaecker, K. (2019). Cancer biogenesis in
506 ribosomopathies. *Cells* 8. doi:10.3390/cells8030229.
- 507 Swanson, M. S., and Winston, F. (1992). SPT4, SPT5 and SPT6 interactions: effects on transcription
508 and viability in *Saccharomyces cerevisiae*. *Genetics* 132, 325–336.
- 509 Tafur, L., Sadian, Y., Hanske, J., Wetzel, R., Weis, F., and Müller, C. W. (2019). The cryo-EM
510 structure of a 12-subunit variant of RNA polymerase I reveals dissociation of the A49-A34.5
511 heterodimer and rearrangement of subunit A12.2. *Elife* 8. doi:10.7554/eLife.43204.
- 512 Tafur, L., Sadian, Y., Hoffmann, N. A., Jakobi, A. J., Wetzel, R., Hagen, W. J. H., Sachse, C., and
513 Müller, C. W. (2016). Molecular structures of transcribing RNA polymerase I. *Mol. Cell* 64,
514 1135–1143. doi:10.1016/j.molcel.2016.11.013.
- 515 Tantale, K., Mueller, F., Kozulic-Pirher, A., Lesne, A., Victor, J.-M., Robert, M.-C., Capozzi, S.,
516 Chouaib, R., Bäcker, V., Mateos-Langerak, J., et al. (2016). A single-molecule view of
517 transcription reveals convoys of RNA polymerases and multi-scale bursting. *Nat. Commun.* 7,
518 12248. doi:10.1038/ncomms12248.
- 519 Turowski, T. W., Petfalski, E., Goddard, B. D., French, S. L., Helwak, A., and Tollervey, D. (2020).
520 Nascent transcript folding plays a major role in determining RNA polymerase elongation
521 rates. *Mol. Cell* 79, 488–503.e11. doi:10.1016/j.molcel.2020.06.002.
- 522 Van Mullem, V., Landrieux, E., Vandenhaute, J., and Thuriaux, P. (2002). Rpa12p, a conserved
523 RNA polymerase I subunit with two functional domains. *Mol. Microbiol.* 43, 1105–1113.
524 doi:10.1046/j.1365-2958.2002.02824.x.
- 525 Viktorovskaya, O. V., Appling, F. D., and Schneider, D. A. (2011). Yeast transcription elongation
526 factor Spt5 associates with RNA polymerase I and RNA polymerase II directly. *J. Biol.*
527 *Chem.* 286, 18825–18833. doi:10.1074/jbc.M110.202119.
- 528 Warner, J. R. (1999). The economics of ribosome biosynthesis in yeast. *Trends Biochem. Sci.* 24,
529 437–440. doi:10.1016/s0968-0004(99)01460-7.
- 530 West, S., Gromak, N., and Proudfoot, N. J. (2004). Human 5' → 3' exonuclease Xrn2 promotes

Running Title: co-transcriptional folding of ribosomal RNA

531 transcription termination at co-transcriptional cleavage sites. *Nature* 432, 522–525.
532 doi:10.1038/nature03035.

533