



HAL
open science

Carbon nanomaterials-based polymer-matrix nanocomposites for antimicrobial applications: A review

Laure Giraud, Audrey Tourrette, Emmanuel Flahaut

► **To cite this version:**

Laure Giraud, Audrey Tourrette, Emmanuel Flahaut. Carbon nanomaterials-based polymer-matrix nanocomposites for antimicrobial applications: A review. *Carbon*, 2021, 182, pp.463-483. <10.1016/j.carbon.2021.06.002>. <hal-03371082>

HAL Id: hal-03371082

<https://hal.science/hal-03371082v1>

Submitted on 8 Oct 2021

HAL is a multi-disciplinary open access archive for the deposit and dissemination of scientific research documents, whether they are published or not. The documents may come from teaching and research institutions in France or abroad, or from public or private research centers.

L'archive ouverte pluridisciplinaire **HAL**, est destinée au dépôt et à la diffusion de documents scientifiques de niveau recherche, publiés ou non, émanant des établissements d'enseignement et de recherche français ou étrangers, des laboratoires publics ou privés.



HAL Authorization





Open Archive Toulouse Archive Ouverte (OATAO)

OATAO is an open access repository that collects the work of Toulouse researchers and makes it freely available over the web where possible

This is an author's version published in: <http://oatao.univ-toulouse.fr/28081>

Official URL: <https://doi.org/10.1016/j.carbon.2021.06.002>

To cite this version:

Giraud, Laure  and Tourrette, Audrey  and Flahaut, Emmanuel  *Carbon nanomaterials-based polymer-matrix nanocomposites for antimicrobial applications: A review.* (2021) *Carbon*, 182. 463-483. ISSN 0008-6223

Any correspondence concerning this service should be sent to the repository administrator: tech-oatao@listes-diff.inp-toulouse.fr

Carbon nanomaterials-based polymer-matrix nanocomposites for antimicrobial applications: A review

Laure Giraud, Audrey Tourrette, Emmanuel Flahaut*

CRIMAT, Université de Toulouse, CNRS, INPT, UPS, UMR CNRS-UPS-INP N°5085, Université Toulouse 3 Paul Sabatier, Bât. CRIMAT, 118, Route de Narbonne, 31062, Toulouse, Cedex 9, France

A B S T R A C T

Carbon Nanomaterials present many exceptional properties, including antimicrobial ones. The transfer of the latter through their incorporation into materials has generated a growing interest with a significant increase in number of publications since 2011. The use of polymeric matrices presents many advantages, because polymers are efficient nanoparticles holders and also exhibit intrinsic antimicrobial properties in some cases. The state of the art of fabrication methods and presumed antimicrobial mechanism is presented, focusing on antibacterial activity as the latter is, by far, the most discussed in the literature. Even if many examples of such nanocomposites are available, most of them correspond to carbon nanomaterials incorporated in the volume, while only the surface is of interest in terms of intrinsic (and thus expected long term) activity, and there is still a lack of information concerning the occurring antimicrobial mechanisms. We have identified the good stability of carbon nanomaterials in biological environment as an interesting option in terms of durability of the antimicrobial effect and will discuss this question in detail, as well as the fact that there are currently no clear conclusions concerning toxicity aspects due to the possible release of such nanoparticles in use conditions.

Contents

1. Introduction	464
2. Microorganisms and antimicrobial tests	464
3. Antimicrobial polymers	465
4. Carbon nanomaterials	466
4.1. Different kinds of carbon nanomaterials	466
4.2. Carbon nanomaterials antimicrobial mechanisms	466
4.3. Carbon nanomaterials functionalization	468
5. Composites	470
5.1. Carbon nanomaterial based composites	470
5.2. Methods of elaboration of nanocomposites	470
5.3. Interaction between the components	476
5.4. Antimicrobial properties of composites	477
6. Conclusion	479
Declaration of competing interest	479
Acknowledgments	480
Supplementary data	480
References	480

* Corresponding author.

E-mail address: flahaut@chimie.ups-tlse.fr (E. Flahaut).

1. Introduction

Microbial proliferation on materials has become a major issue in various fields. Whether used in transports, biomedicine or environmental conditions, materials are confronted to microbes proliferation leading to global health and economic issues. Microbes include bacteria, fungi, algae, protozoa, and amoebas, and are generally described as sources or vectors of diseases. For example, materials placed in environmentally challenging conditions are indeed faced to the issue of biofilm formation. A biofilm is a structured agglomeration of microorganisms embedded in a self produced matrix that adheres to a surface. Once formed, microorganisms in a biofilm are very difficult to remove compared to individual entities, as this structure behaves as a reservoir of microbes and offers them protection from antimicrobial agents [1,2]. Fighting against biofilm formation is a great issue for materials immersed in aquatic media for instance, as their functionality and life expectancy become limited with the appearance of a biofilm [3]. It is also a problem for implantable medical devices, the development of resistant bacterial biofilm leading to an increase in mortality by nosocomial infection and being as such an important sanitary concern [4,5].

Antimicrobial materials represent an alternative to limit or eradicate microbial proliferation, either because they can directly kill or damage microbes, or because they can prevent cell adhesion onto their surface, such as passive antimicrobial polymers based materials for example [6–8]. Antimicrobial compounds able to inhibit bacterial proliferation are important because numerous bacteria have become resistant to antibiotics [9–11]. Anti infective agents with other action mechanism have been developed, such as metal ions [12], quaternary ammonium salts [13–16], and nanoparticles [17,18]. This is why the use of silver (Ag) nanoparticles is widespread as it is efficient and works differently from antibiotics [19,20]. Among all the investigated nanoparticles, carbon based nanomaterials (CNMs) represent a specific category. Albeit known and exploited in many fields due to their exceptional properties, they have recently gained further attention thanks to their antimicrobial activity [21,22]. Most studies to date have highlighted their action as free particles in suspension [23–25], but not included within a material. CNMs may also be combined with other antimicrobial agents such as Ag [26,27] or ZnO [28,29] for enhanced efficacy.

However, the use of nanoparticles in general for such applications raises potential issues, including the durability of their action and their potential own toxicity. The durability issue is directly related to the number of nanoparticles present in the material, which could be time limited as nanoparticles may be progressively released or dissolved in the medium to be treated. The main advantage of carbon nanomaterials (CNMs) is that they are very chemically resistant and thus not soluble, and will as such be kept at the same amount in antibacterial materials with no expectable loss of activity with time. Regarding the release of the nanoparticles themselves (related to ageing of the material due to abrasion, weathering, etc.), their potential intrinsic toxicity towards both humans and the environment should also be considered [30–33]. Therefore, composite materials containing embedded nanoparticles are now investigated. As polymers proved to be both efficient nanoparticle holders and to demonstrate intrinsic antimicrobial properties in some cases, we have decided to focus this review on polymer based nanocomposites [34].

In a first part, the different microorganisms which have been investigated so far in the literature in this context will briefly be presented, as well as the tests used to assess the antimicrobial activity of materials, which are usually different from the ones used for particles in suspension. Focusing on polymer based materials,

the different antimicrobial strategies which have been proposed will then be compared: after describing the specific case of polymers exhibiting an intrinsic antimicrobial activity, the antimicrobial properties of carbon nanomaterials will be listed before finally reviewing polymer based antimicrobial nanocomposites containing CNMs. In each case, attention will be paid to fabrication methods, antimicrobial tests used (along with the tested microorganisms) and presumed antimicrobial mechanism. Some examples of potential applications will also be discussed, and general conclusions will be proposed.

2. Microorganisms and antimicrobial tests

Microorganisms are micro living entities that are part of our daily live. Composing about half of the human body [35] they are mostly essential for our proper functioning, although some of them have pathogenic effects on human beings. Microbes (the science of which is called microbiology [36]) include several types of microorganisms exhibiting different forms, among which fungi, bacteria or protozoa may be cited. This term does not include viruses that are usually considered on the borderline of living organisms, or even as non living, infectious entities. Fungi are eukaryotic components, usually filamentous with cell walls containing chitin, that include entities with a lot of variation in size and structure. Although associated to plants for a long time, they miss many of their main characteristics (absence of chloroplasts, chlorophyll and starch) [37]. Bacteria are unicellular microorganisms with a size ranging from 1 to 5 μm . At least composed of cell walls, plasmic membrane, cytoplasm and genetic material, they are capable of reproduction via cellular division (contrary to viruses). They are classified through their cell walls nature into Gram negative or Gram positive categories. Gram negative bacteria have a thin peptidoglycan layer of 6–15 nm and an outer lipid membrane whereas Gram positive bacteria have a thicker peptidoglycan layer of (20–80 nm) and miss the outer lipid membrane [38]. Contrary to bacteria, a virus is not an autonomous entity that can reproduce independently. Smaller than bacteria (20–500 nm), it is at least composed of genetic material surrounded by a protein shell known as a capsid [37]. Thus, the effect of antimicrobial agents varies depending on the type of microorganism because of their different structures. There are different kinds of antimicrobial activity assays available in the literature [39], and they can generally be used with most antimicrobial agents to test their activity against pathogens, whatever their form (polymers, composites, or suspensions of nanoparticles).

Literature mostly reports the use of assays such as inhibition zone, colony counting or optical density (OD) measurements to quantify the antimicrobial activity of materials. These global methods, giving information at the level of the whole population of microorganisms, may roughly be summarized in three steps: contact between microorganisms and the sample, retrieval of microorganisms, and finally investigation of microorganisms' proliferation with comparison with a control condition [40].

The inhibition zone assay or disc diffusion test (Fig. 1a) is a qualitative diffusion method frequently used and consists in filling petri dishes with a microbial solution of known concentration mixed with a nutritive medium (Luria Bertani agar medium; Mueller Hinton Agar medium, etc.). The tested materials are then added onto the bacterial lawn and the plate is incubated. Afterwards, the radius of inhibition zone (mm) is measured and reflects the antimicrobial activity of the sample. An antibiotic disc may be used as a positive control [41,42]. Further variations of this diffusion method exist, such as the agar plug diffusion method [43] or the agar well diffusion method, that allows to test the antimicrobial activity of plants [44]. It is also possible to quantitatively measure

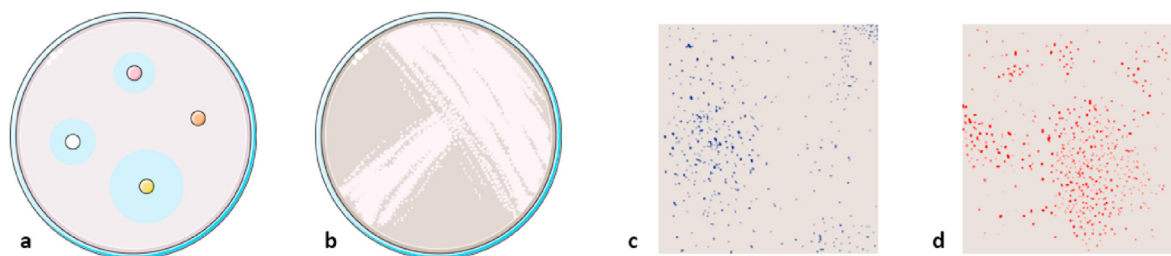

Fig. 1. Schematic illustration of the antimicrobial assays, a) Inhibition zone assay and b) colony counting assay (representation of these assays in petri dishes filled with nutritive medium), and fluorescence assay, cells stained with c) DAPI or d) PI (on glass slides). (A colour version of this figure can be viewed online.)

the antimicrobial activity of bacteria or fungi via dilution methods. The same type of tests previously presented are applied to microorganisms that are confronted to various concentrations of antimicrobial substance and the minimum inhibitory concentration (MIC) may be determined, as in the agar dilution or broth dilution methods [45].

The colony counting assay (Fig. 1b) is widespread. After the incubation of the tested samples with a microbial solution of known concentration, microorganisms are retrieved and then incubated into a culture medium before processing to colony counting to measure their viability [46]. Microbial growth following exposure to an antimicrobial agent is mainly measured by assessing the optical density after the microorganisms have been resuspended in water [47]. Such tests thus allow to deduce the antimicrobial properties of samples through the control of their impact on the proliferation of microbes upon contact. However, they don't give any indication about the mechanisms of action. Another way to assess the effect of antimicrobial agents is to evaluate their impact on the microbes at the individual scale. Other reported tests such as RNA/DNA measurements, instead of measuring optical density, aim to detect RNA (or DNA) via spectrophotometry (or chromatography) to allow the estimation of impacted cells.

Fluorescence assays (Fig. 1c–d) are described in numerous papers and allow to gain information on damaged cells. However, they usually cannot be applied directly to the surface of a material (unless it is transparent), because the cells need to be placed on a transparent glass slide. After incubation, bacteria adhering to the tested surface sample are retrieved and put into a culture medium. Stain is then added to determine the live/dead cell ratio. SYTO9 (green fluorescence emission at 503 nm) is among the most used stains. This is a green fluorescent nuclear and chromosome counterstain that is permeant to both prokaryotic and eukaryotic cell membranes. SYTO 9 stain has a high affinity for DNA and exhibits enhanced fluorescence upon binding to DNA. It stains both live and dead Gram positive and Gram negative bacteria. Another example is 4',6'-Di Amidino 2 Phenyl Indole (DAPI, blue fluorescence emission at 461 nm) which also stains mainly DNA, but passes only through intact cell membranes (live, or fixed) and can thus be used to assess cell viability. It can also bind to RNA, but in this case the fluorescence emission maximum is up shifted to ca. 500 nm. Finally, propidium iodide (PI, red fluorescence emission at 617 nm) easily penetrates the damaged, permeable membranes of non-viable cells but is excluded by viable cells. It binds to double stranded DNA by intercalating between base pairs. Fluorescence imaging finally reveals stained cells, and as such the antimicrobial activity [47,48]. Thereby, these methods confirm impacts on cell membrane integrity (with the possible release of cell components), but they do not indicate the specific process leading to this deterioration. Other assays take advantage of fluorescence detection after addition of a reagent that allows the identification of certain specific components (Metabolic assay, Reactive oxygen species

assay, assessment of membrane lipid peroxidation, etc.) and are thus very relevant to investigate mechanistic aspects [48–54].

Microscopy imaging may be used to observe cell adhesion using a simple optical microscope. Much more details may be obtained using electron microscopy, either in scanning (SEM) or transmission mode (TEM) to detect morphological changes of cells after incubation with the tested sample, or to detect biofilm formation. Atomic Force microscopy (AFM) may also be used to measure surface topography and indicate the formation of biofilm or not [48,55]. It may also be used to investigate the mechanical properties of cell membranes [56,57]. Of course, microscopy imaging by AFM, SEM or TEM are not high throughput and require long sample preparation steps so these techniques are not used routinely to assess the antimicrobial activity (they also miss the quantitative aspect), but only to investigate mechanistic issues.

Most publications on antimicrobial activity of carbon based nanomaterials focus particularly on the antibacterial activity. As may be seen in section 5.2, the colony counting, zone inhibition or the fluorescence tests are frequently used to assess the antibacterial activity of the tested materials, with in particular the main use of gram negative bacteria *E. coli*. Authors also regularly report the use of gram negative *P. aeruginosa* and gram positive *S. aureus* and *B. subtilis* in antibacterial tests [48,58–60]. These models of bacteria are frequently identified as nosocomial infections. They may develop resistance to antibiotics and as such are of important sanitary concern [11]. It is thus very relevant to use these types of bacteria to assess the antibacterial activity of materials. Other studies also present, to a lesser extent, the evaluation of antimicrobial activity of carbon based nanomaterials against certain types of fungi or viruses [53,61,62].

3. Antimicrobial polymers

Antimicrobial polymers are briefly described here because they may be used in association with CNMs to enhance their intrinsic activity and thus need to be described to understand the role played by each different part in a nanocomposite material. They fight against pathogens through active or passive pathways. Active polymers kill microbes upon contact via electrostatic or biocidal interactions. On the contrary, antimicrobial passive polymers fight against pathogens mainly by preventing their adhesion through repelling them from the surface. As microbes are mainly hydrophobic or negatively charged, a repulsive mechanism may be obtained by controlling the hydrophilicity, charge properties and surface energy of the polymer [6]. For example, Poly(ethylene glycol) (PEG), is used to prevent protein and cell adhesion due to its hydrophilic surface [63]. According to their structure, antimicrobial polymers may be sorted in 3 categories: polymeric biocides, biocidal polymers and biocide releasing polymers [6]. Polymeric biocides are polymers formed by a succession of bioactive units. In biocidal polymers, on the contrary, the activity is provided by the

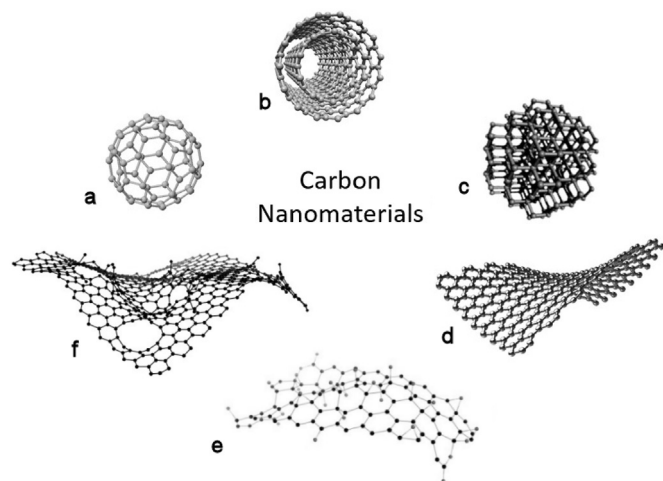

Fig. 2. Carbon nanomaterials: a) Fullerene (C_{60}); b) Carbon Nanotube (CNT); c) Nanodiamond; d) Graphene; e) Graphene Oxide (GO, oxygen atoms shown in red); f) reduced Graphene Oxide (rGO). Adapted from Ref. [30].

whole macromolecule. Most biocidal polymers actively damage cells membrane through electrostatic interactions. There are indeed lots of examples of biocidal polymers containing cationic groups such as quaternary ammonium [64,65], phosphonium [66,67], tertiary sulfonium [68] or guanidine [69]. In contrast, biocide releasing polymers usually have no intrinsic activity but only act as a container releasing antimicrobial substances such as for example gentamicin, triclosan or silver among the most commonly cited [7,70]. For further information on these polymers, the reader may refer to detailed reviews on this topic [6,8,71]. In this document, the focus is specifically on polymers including carbon nanoparticles as antimicrobial agent.

4. Carbon nanomaterials

4.1. Different kinds of carbon nanomaterials

CNMs (Fig. 2) exhibit a large variety of shapes from 0D (nanodiamonds, fullerenes), to 1D (nanotubes) and 2D graphene and related materials (graphene, graphene oxide, reduced graphene oxide). One common property of all carbon nanomaterials is the possibility to functionalise them by grafting different surface functional groups with important consequences on their hydrophobicity/hydrophilicity, surface charge, electronic, optical and often also mechanical properties. The most common way of doing so is through simple oxidation, leading to the grafting of oxygen containing functional groups, and is often a consequence of purification treatments [72]. Many much more sophisticated procedures have already been extensively reviewed [73]. Nanodiamonds are 0D nanostructures composed of sp^3 hybridized carbon atoms at the core, often surrounded by sp^2 carbon atoms and functional groups [74]. They exhibit exceptional mechanical and optical properties, along with a specific surface area commonly between 200 and 600 m^2/g [75–78]. Their properties depend upon the sp^3/sp^2 ratio [21,79]. Graphene is a 2D material forming a planar structure of one atomic layer. It is composed of sp^2 hybridized carbon atoms arranged in hexagons, and represents the basic structure found in other nanomaterials such as fullerene and

carbon nanotubes (CNTs) [21]. The classification of graphene and related materials (GRM) may be defined through the number of layers, the average lateral size, and the carbon to oxygen (C/O) atomic ratio (Fig. 3) [80], this last parameter having the highest impact on their physico chemical properties. The superposition of 2–10 layers leads to Few Layer Graphene (FLG), whereas the presence of 10 sheets of graphene or more is described as graphite nanoplates. Graphene Oxide (GO) corresponds to a single layer of graphene bearing many kinds of oxygenated functions, and its reduction leads to reduced Graphene Oxide (rGO). While graphene has exceptional physico chemical properties and is highly hydrophobic, with a specific surface area theoretically reaching 2600 $m^2 g^{-1}$, good electronic mobility and mechanical properties [81–83], GO is on the opposite an insulating but highly hydrophilic material and it is more easily dispersed than its non functionalized counterpart [84].

Fullerenes are spherical 0D closed nanostructures containing a majority of sp^2 hybridized carbon atoms (C_{60} [21,22], C_{70} , C_{76} , C_{78} , C_{84} etc.). Fullerenes also present size and structure dependant properties (optical, mechanical, chemical, electrical) [85]. Finally, a Carbon Nanotube (CNT) can be described as a rolled graphene sheet generally closed by hemifullerenes. Single Wall Carbon Nanotubes (SWCNTs) have a small diameter typically of only a few nanometres or less; they can behave as semiconductors or metals depending on their electronic structure. Multi Wall Carbon Nanotubes (MWCNTs) composed of concentric SWCNTs may reach up to 100 nm outer diameter [21]. Similarly, intrinsic parameters such as their diameter, length, number of walls and the presence of functional groups play a significant role on their properties [86].

For all these reasons, CNMs are used for numerous applications, from sensors, optical devices, superconductors, to drug delivery systems and biomedical applications in general, including their antimicrobial properties [81,85,87]. It is important to mention here that an abundant literature has been dedicated to the issues of the potential toxicity of carbon nanomaterials towards humans [88,89] and the environment [90] since the early beginnings of this research field. Antimicrobial activity of carbon nanomaterials is related to the same kind of mechanisms but is considered in a positive way because it is targeted toward the elimination of pathogens. Most of the work related to CNMs has focused on the prevention of biofilm formation and/or elimination of bacteria.

4.2. Carbon nanomaterials antimicrobial mechanisms

Antimicrobial behaviour of CNMs in suspension in a liquid has been the main focus in the literature to date because this is the most common way to expose cells in culture. Authors have reported so far two main antibacterial mechanisms: physical damage and oxidative stress.

CNMs may indeed impart mechanical damage to microorganisms through perforation of the outer membrane upon contact, causing the loss of cell components and in consequence cell death. The exact mechanism may slightly change upon the type of nanomaterial. For example, graphene (or more likely FLG) may be considered as a “nano knife” (2D) cutting the membrane, whereas it would be more accurate to describe a CNT as a “nano dart” (1D) (Fig. 4a) while these 2 approaches certainly depend on the mechanical rigidity of the nanoparticles: indeed, it does not seem very realistic to consider actual graphene, a very flexible nanomaterial, as a knife while this may be more likely in the case of FLG, which is much more rigid. The same applies to CNTs, where few walled CNTs such as SWCNTs and DWCNTs are more likely to be progressively included within the cell membrane while more rigid MWCNTs may indeed penetrate like needles (Fig. 4a).

³ Dezeen, <https://www.dezeen.com/tag/graphene/>.

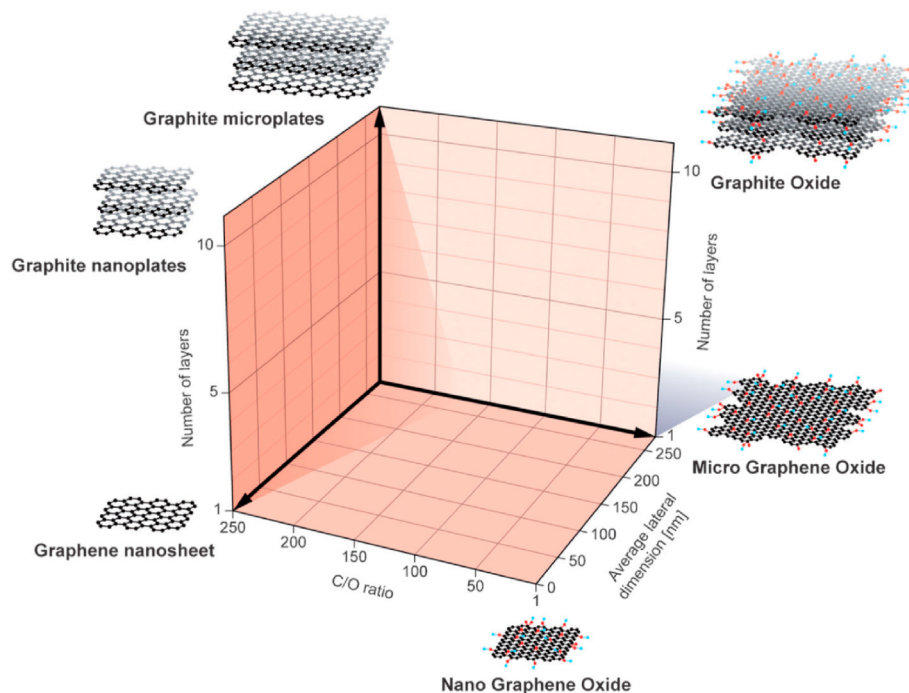

Fig. 3. Classification grid for the categorization of different graphene types according to three fundamental graphene-based materials properties: number of graphene layers, average lateral dimension, and atomic carbon/oxygen ratio. Reprinted with permission from Ref. [80]. (A colour version of this figure can be viewed online.)

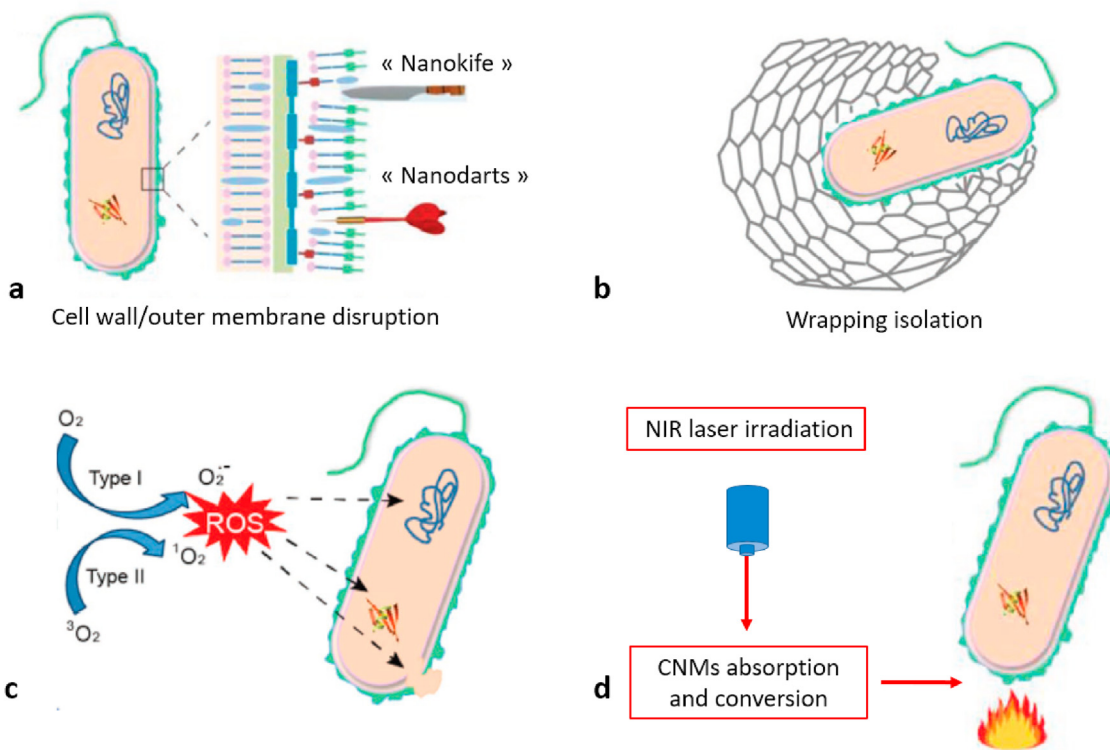

Fig. 4. Schematic illustration of a) the physical/mechanical damage caused by CNMs on bacteria; b) Wrapping isolation antibacterial action of CNMs; c) ROS oxidative stress-based antibacterial action of CNMs; d) Photothermal effect based antibacterial action of CNMs. Adapted from Ref. [21]. (A colour version of this figure can be viewed online.)

Destabilization of Bacterial membrane may also be obtained via electrostatic interaction with the nanomaterials. This is expected with functionalized carbon nanomaterials, especially when they have been oxidised and bear carboxylate (COO^-) groups on their

surface. Furthermore, the separation of microorganism from their microenvironment via isolation is another possible mechanism. For example, a graphene sheet may wrap itself around a microorganism and block its access to nutrients, this action is illustrated in

Fig. 4b. The proliferation is then stopped and the microorganism may be destroyed [81,91]. CNMs have also been reported as being able to inhibit cellular division of cancer cells. Biomimetic properties of MWCNTs that allow them to interfere with microtubules were reported [92]. These intracellular proteins are nanotubes presenting similarities with MWCNTs, and play a central role in cellular motion and division. MWCNTs interaction with microtubules filaments leads to interferences and finally inhibits cells proliferation. Although examples of this mechanism were not described so far in the literature, it is supposed that it may also be active against microbial pathogens.

Oxidative stress mechanisms also must be considered to understand antimicrobial activity of CNMs. Chemical interactions between the latter and microorganisms' surface may lead to inflammatory reactions with the production of Reactive Oxygen species (ROS) (Fig. 4c). These species may damage lipids, proteins and DNA of bacteria and cause membrane peroxidation, leading to the cell's death. It is worth mentioning that this may strongly depend on the nature of the carbon nanomaterial because fullerenes and carbon nanotubes may simultaneously exhibit intrinsic antioxidant properties [93–95]. In addition, redox reactions may take place with a charge transfer between nanomaterials and bacteria. CNMs may attract cells electrons and cause biological mechanisms such as respiration to stop [21,22,85,96,97]. Bacteria, contrary to eukaryote cells, have no mitochondria and reactions associated to the respiratory chain are localised in the cell membrane. CNMs may accept an electron from the respiratory chain and inhibit the transport reaction leading to a bactericide effect [98,99]. Unlike viruses, fungi have mitochondria, however studies on CNMs impact on fungal mitochondria were not found in the literature. To date, examples of mitochondrial injuries induced by CNMs were only described in mammal cells [100] or in plant cells [101].

It is likely that the intrinsic antibacterial activity of CNMs is related to a combination of physical and chemical mechanisms. Other properties of CNMs may be combined to enhance such activity [97]. Among different possibilities, CNMs may decrease bacterial viability through photothermal effect with the absorption and conversion of NIR laser irradiation into local heating (Fig. 4d) [81,102–105]. Local heating may also be achieved under microwave irradiation, where stimulated CNTs may induce bacteria thermal ablation [106,107], or under acoustic waves where CNMs may adsorb acoustic energy to induce hyperthermia of cancer cells [108–110]. Hyperthermia mechanisms are frequently used in cancer therapy and might also be applied against bacterial pathogens [106].

Although CNMs antibacterial activity can be obtained through several mechanisms, it is likely that the latter depends on many parameters such as the environment and the nature of the microorganisms. Our survey of the current literature highlights that most of the work published so far has focused on CNTs and GRMs, and especially GO. Furthermore, important differences for a given nanostructure were also identified, depending on its intrinsic parameters, including the particles size, thickness, and surface chemistry [61,111]. For instance, GO is more efficient than graphene because the oxygen groups facilitate its dispersion, thus allowing better cell/particle contacts. This may also be related to the surface charge effect described earlier (at biological pH, carboxylic functions should be present as negatively charged carboxylates). In addition, size is an important parameter as a small graphene sheet may penetrate and diffuse into a cell without seriously damaging the membrane, while this would be very different for larger sheets. CNTs also have different action mechanisms upon their size. Shorter tubes seem to have more opportunities for cap/cell interaction and thus should be more efficient [112]. However, longer nanotubes may cause damages inside the cell while transiting and

thus increase the antimicrobial activity [113]. Therefore, it is difficult to predict the particles action and their efficiency [114]. Although most earlier reviews have tried to highlight relationships between the physico chemical parameters of CNMs and their antimicrobial activity, no clear conclusions have been established so far. Authors remain cautious with the mention of phenomena that remain difficult to clearly evidence or even controversial [61,115]. The explanation is that there are too many parameters to consider, from the particles themselves, to the biological environment, the type of microorganism tested and the type of assay. It is thus very challenging to compare existing studies and to draw general conclusions. New studies should be conducted using standardized experimental procedures in order to reach this goal. The grouping and read across concepts may help to progress towards this goal [116].

After having reviewed the intrinsic antimicrobial properties of CNMs, the situation of their combination with other known antimicrobial agents will now be discussed. To date, the following associations have been described in the literature: CNMs functionalization with Nano Ag, metals, photocatalytic agents, and antibiotics. This description of the state of the art is important because part of the mechanisms proposed in the case of the CNMs dispersed in a liquid medium may not apply when they are immobilized in the case of an antimicrobial surface.

4.3. Carbon nanomaterials functionalization

Functionalization of CNMs (Fig. 5) has already been extensively described and this is not the goal here to review this topic, but only to present and discuss relevant functionalization approaches for antimicrobial applications. In the vast majority of examples found in the literature, the functionalization was obtained by non covalent adsorption of nanoparticles and/or (antibiotic) molecules, sometimes involving pi stacking interactions.

Combinations between CNMs and Ag nanoparticles (AgNP) have been widely studied to enhance their antimicrobial activity (Table S1) [27,61,97,117–119]. The use of AgNPs is popular due to their intrinsic antibacterial properties. The antimicrobial activity of silver comes from Ag⁺ ions and the reason why Ag nanoparticles are more potent than direct exposure to the ions is that while the entry of the latter into the cells may be prevented by some defence mechanisms, nothing would block the penetration of the nanoparticles which can later dissolve directly in the cytoplasm and release Ag⁺ ions where nothing can block their diffusion. Ag⁺ ions may then react with DNA or proteins and cause cell death [26]. The adherence of AgNPs on microbes is likely to induce ROS generation [120,121]. The antimicrobial activity of AgNPs depends greatly on their size and dispersibility [122,123]: the large specific surface area of CNMs ensures a good dispersion of the AgNPs upon grafting [26,97,120]. Furthermore, synthesis processes on CNMs have been developed to control AgNPs size, ensuring an enhanced antimicrobial activity [120].

Literature also reports CNMs functionalization with other metals or their corresponding oxide to enhance their antimicrobial properties (Table S1). Adsorption of Fe on graphene was mentioned as a good combination for enhanced adsorption of contaminants in the water such as Cr, As and Pb [124]. It is also possible to modify the electrical properties of CNMs upon their functionalization with metals [125,126]. For instance, deposition of graphene on p doped Ge was evidenced to attract electrons from the respiratory chain of a microorganism [127]. This action combined to the ROS production of the nanomaterial leads to the death of microorganisms. The antimicrobial effect of metal ions combined to CNMs was also identified [128]. The enhanced antimicrobial action of a graphene sponge decorated with Cu ions was reported [129]. Cu ions are able

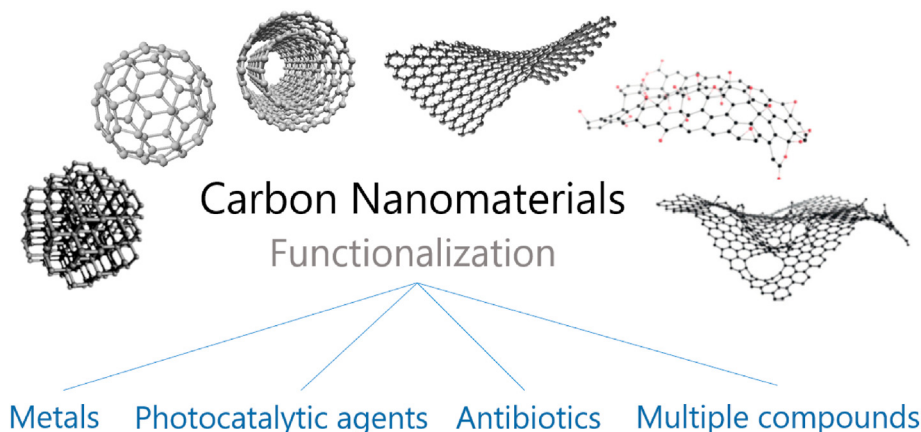

Fig. 5. CNMs possible functionalization described in literature. Adapted from Ref. [30]. (A colour version of this figure can be viewed online.)

to interact with DNA and to stop its replication [130], leading to the microorganism death.

The combination of CNMs with metal oxides is also effective to fight against microorganisms [61] and graphene ZnO nano composites [131,132] or CNT functionalization with ZnO have been reported [133]. ZnO graphene has an enhanced antimicrobial activity compared with pristine graphene [134], the composite inducing death by interacting with its proteins [28] and presenting a long lasting activity due to graphene slowing the dissolution of ZnO [29,135]. Many other examples may also be found, such associations of CNMs with as CuO [130,136], SnO₂ [137,138], Co₃O₄ [139,140], WO₃ [141], and PbO [142].

It is possible to confer photocatalytic properties to CNMs by association with a photocatalytic agent (Table S2). A photocatalytic agent can produce ROS under light irradiation, and as such they may deteriorate microorganisms via oxidative stress. As already discussed, CNMs exhibit photothermal activity, good electrical conductivity and easily produce photo induced electron; thus CNMs are good base materials for photocatalytic functionalization [123,143]. TiO₂ is a well known photocatalytic agent that has been used to form CNMs based composites exhibiting antimicrobial action under solar light irradiation [144–150]. Literature also reports CNMs functionalized with other photocatalysts such as ZnO [151–153], CdS [154,155], MnS₂ [156], WO₂; WO₃ [157], Cu₂O [158], Ag₃PO₄ [159], g C₃N₄ [160].

Authors also explored the association of CNMs with antibiotics (Table S3). The utilization of CNMs exhibiting different mechanisms of action than antibiotics allows them to overcome the issue of the development of resistance from some microorganisms such as *E. coli* or *S. aureus*. The synergistic effects of CNMs and antibiotics produces a composite with an increased antibacterial activity compared to its individual counterparts [161–163]. Association of GO and Tetracycline (TET) was reported to enhance the interaction between the antibiotic substance and microorganisms [164]. Two modes of contact influenced by GO were observed such as the wrapping of the nanocomposite on the resistant bacteria. The important concentration of Tetracycline on GO and the direct contact with the cell does not allow the efflux pump gene responsible of the antibiotic resistance of the bacteria to eject TET from the cell. A CNT lysine nanocomposite also presented a better antimicrobial activity than its pristine counterparts with the direct contact mechanism of CNT allowing the antibiotic to diffuse into the cell and avoid rejection from the microorganism [165].

The use of CNMs as a substrate was also proposed to increase the dispersion and stability of antibiotics. SWCNT ciprofloxacin exhibited good dispersion and stability for over 6 months [166].

Moreover, the functionalization of CNMs with antibiotics allows more control over the release of the substance [167] and thus the requirement of lower quantities.

Finally, there are many examples of functionalization of CNMs simultaneously by different compounds to further enhance the properties of the nanocomposite (Table S4). Multiple metals or oxides may be used, such as bimetal functionalization of CNTs exhibiting enhanced activity compared to single metal based nanocomposites [168–170]. The functionalization of graphene with Cu and Ag nanoparticles where the synergistic action of the metals on the graphene support increased the composite antimicrobial activity was reported [171]. It is also possible to optimize the photocatalytic action of CNMs [172–174]. The photocatalytic degradation activity of SWCNTs functionalized with Cu and TiO₂ for pharmaceutical wastewater decontamination was mentioned in literature [175]. The combined effects of TiO₂ as a photocatalytic agent and Cu (antimicrobial) enhanced the global photocatalytic activity. Combination with a polymer is another way to increase CNMs antimicrobial activity [176–178]. A zinc oxide multiwalled carbon nanotube poly(vinyl chloride) ternary nanocomposite with increased antimicrobial and biocompatibility properties due to the synergistic effects of the compounds was reported [179].

These different examples of CNMs functionalization for antimicrobial application highlight the synergistic effects of such nanocomposites. Unfortunately, this approach has only been validated in suspension, and not after immobilisation on a surface. Even if the improvement of the dispersion of antimicrobial compounds offered by CNMs may be transposed to the surface of materials, the issue of the durability of the action is generally not solved because of the need for the release of the antimicrobial substance from CNMs (dissolution of metal ions, release of antibiotic molecules). The photocatalytic properties of CNMs associated to a photocatalytic agent is one exception.

Finally, CNMs antimicrobial properties and the associated mechanisms could also occur in case of contact with human or animal cells, which raises the issue of the balance between benefits (antimicrobial activity) and risks (toxicity/environmental impact) [30–32]. Numerous studies have been conducted to determine the potential toxicity of CNMs, nonetheless it is difficult to draw general conclusions. Indeed, the comparison of studies is delicate because, as previously discussed, nanoparticles effects depend on many parameters that may even vary upon the environment [114]. The same phenomenon dealing with the establishment of relationships between the physico chemical parameters of CNMs and their biocidal activity also exists for their toxicity assessment. Even if hazard is not always demonstrated, solutions to avoid this issue

have been investigated, the most obvious one being their inclusion in composite nanomaterials to limit the release and associated toxicity. This approach is in line with the safer by design strategy which aims at proposing engineering solutions to make possible the responsible use of nanomaterials.

5. Composites

5.1. Carbon nanomaterial based composites

Since the last 10 years, the development of carbon nanomaterial based composites for antimicrobial applications has received increased scientific attention as illustrated in Fig. S5.

In 10 years, the number of publications concerning antimicrobial composites containing carbon nanomaterials has gradually increased. We found that the activity in this field started in 2011 and did not evolve much until 2014, when it started to grow regularly to reach 87 publications in 2020. This may be explained by the increasingly easier access to carbon nanomaterials during the last decade, and the growing need for new strategies to fight against microorganisms.

The inclusion of nanoparticles within composite materials allows for a whole material to benefit from the advantageous properties of the nanoparticles without the potential toxicity issue because of their trapping in the matrix, preventing their release. It appears interesting and promising to study the transfer of these particles' properties into a bulk material following their incorporation into the matrix as such materials find various applications, especially in the medical area with the fabrication of implantable medical devices or antimicrobial textiles. Because the interaction between pathogens and the material occurs only at the surface, it seems unnecessary to disperse CNMs in the bulk, and this topic will be further discussed later. In the current context of worldwide sanitary crisis due to the spread of COVID 19, graphene has been highlighted with for example the development of graphene based respiratory masks, commercialised by several companies. Among them, IDEATI¹ proposes a cotton mask coated with graphene and other carbon nanomaterials that is reusable and displays antibacterial properties, although antiviral properties of graphene have not been clearly demonstrated so far. Bioserenity² proposes a reusable mask containing 4 layers, one containing graphene and said to display antiviral properties. Dezeen³ developed a system where graphene contained into the mask is able to conduct electricity in order to produce charges and to repel trapped particles. Thus, graphene has become very interesting for medical research and industry as a way to limit COVID 19 proliferation among the population. Uses were mostly found in the medical area [52,60,62,180], but also for environmental applications with the new filters for water purification [49,181,182] or in the food industry with food packaging [58,91,183] for example.

Certain CNMs are preferred for the elaboration of antimicrobial nanocomposite materials. This concerns CNTs and graphene, along with their oxidised forms. This may be related to the availability of these materials, CNTs becoming of easier access with their decreasing cost. This selection may also result from their different intrinsic properties. The literature describes GO as the easiest to manipulate among all other CNMs because of its higher dispersibility, especially in water [184,185], while graphene (FLG) is rather difficult to disperse properly. This is due to the presence of oxygenated functions at the surface of GO which induce a better hydrophilicity and increased antimicrobial activity, possibly also related to the enhanced dispersibility. These CNMs (CNTs and

graphene, oxidised or not) are also mostly chosen because of their established antimicrobial properties in literature [97,186]. Overall, GO appears as the most investigated CNM among all antimicrobial CNM based nanocomposites, followed by CNTs.

The different types of polymer based composites containing CNMs will now be presented through their elaboration method and antimicrobial action. Fig. 6 illustrates the different possible situations that we have identified.

Active and passive routes refer to their main mechanism of action. In the passive route, the surface of the material mainly prevents microbial adhesion, without necessarily damaging the pathogen. In the active route, there is on the contrary some antimicrobial action leading to cytotoxic effects, ideally ending up with cell death. Most of the processes described to prepare bulk composites or coating composites for the active route may also be used for the passive one. We focus here on active materials not releasing nanoparticles, in a purpose of avoiding issues related to toxicity and loss of activity with time. Different situations may occur among antimicrobial CNM based nanocomposites. Most matrices usually reported in the literature do not exhibit intrinsic antimicrobial properties. The purpose of their use is to disperse them in order to enhance their activity, while also trapping them and preventing unwanted release. In some other cases, the matrix may also exhibit antimicrobial activity as described earlier, that combine with those of the CNMs. Finally, sometimes the addition of CNMs is not related to their antimicrobial properties but only aiming at mechanically reinforcing a matrix already exhibiting its own antimicrobial activity. These different situations will now be described and commented.

Biocompatible matrices will be used for biomedical applications, and the question of their stability in use conditions is a very important criterion because their biodegradation would lead to the release of the CNMs. For instance agarose is a good binder [182] and the biocompatible properties and low toxicity of PVA (Poly(vinyl alcohol)) makes it an ideal candidate for biomedical applications, but their biodegradation properties must be considered [187].

Polyvinyl N carbazole (PVK) was used to prepare nanocomposite materials with enhanced dispersion of CNMs, allowing a better contact between nanoparticles and pathogen agents, thus improving the antibacterial activity [47,181]. A better antibacterial activity from PVK GO modified surfaces compared to GO modified ones was reported [55].

On the contrary, some works mentioned the use of polymers presenting intrinsic antimicrobial activity. Examples include PVA/Chitosan [188]: chitosan, with its cationic nature, is indeed known for its antibacterial activity as a biocidal polymer with direct action [189]. The incorporation of GO particles increased the antibacterial effect of the material, leading to the conclusion that a synergistic effect occurred. Furthermore, the incorporation of CNMs may improve polymers general properties as well: such nanocomposites may thus exhibit enhanced mechanical and hydrophilic properties, in addition to their antibacterial ones [190,191]. Some articles even reported antimicrobial composites containing CNMs only added to improve the physical properties. The addition of MWNTs into a CS/PLA (PLA: polylactic acid) matrix was indeed mentioned for impacting only its mechanical (tensile and bending) properties [91].

5.2. Methods of elaboration of nanocomposites

In this section, the different methods of elaboration of nanocomposites are described and antimicrobial properties as well as proposed mechanisms are discussed later, but are gathered in Table 1. Two different types of nanocomposite materials may be found depending on the presence of the CNMs in the bulk or only at

¹ planarTECH Graphene Facemask, <https://planartech.co.uk/>.

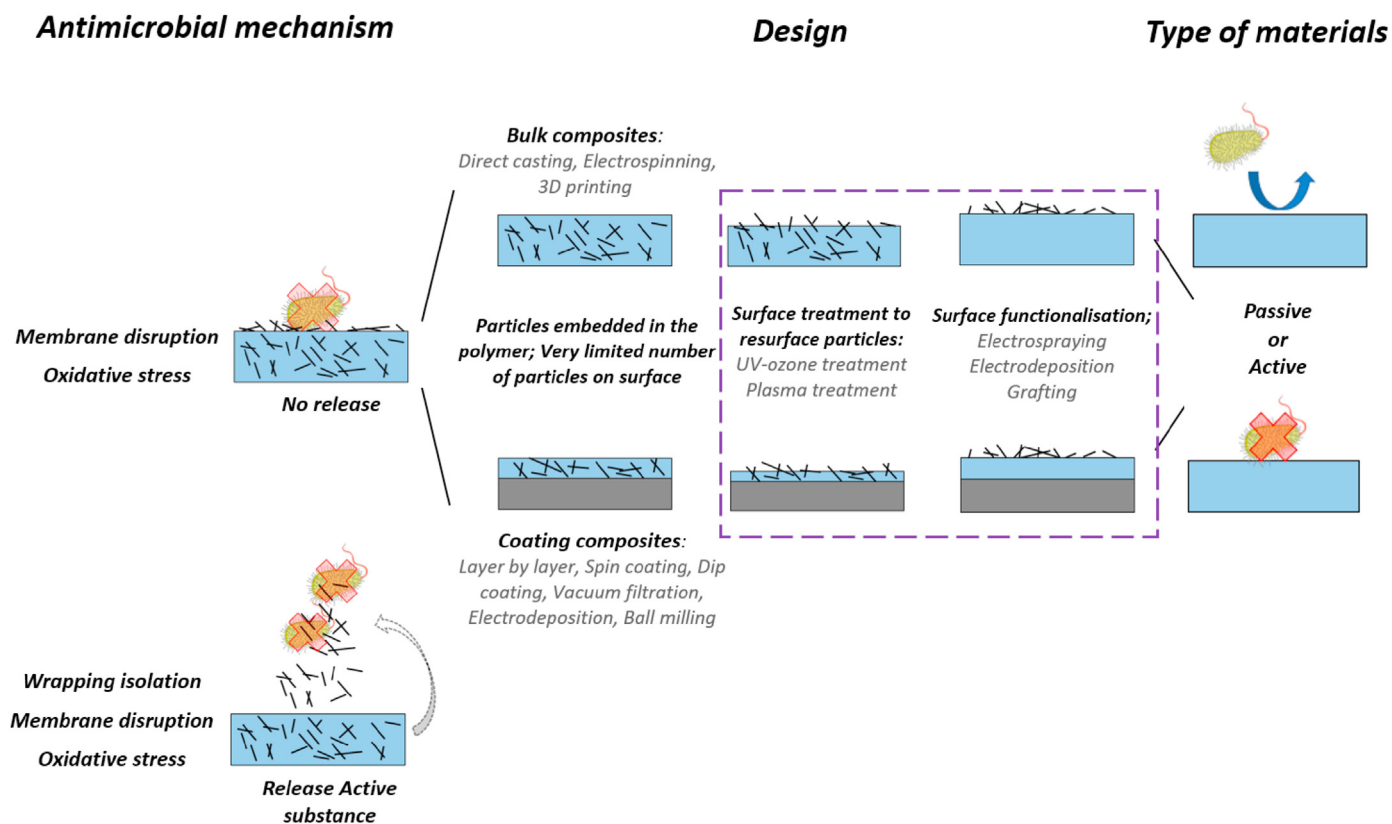

Fig. 6. Scheme illustrating the antimicrobial action of composites containing CNMs depending on their design. The passive route corresponds to the prevention of bacterial adhesion (without killing the bacteria), while the active route leads to bacterial killing. The frame highlights different techniques that allow the creation of composites containing CNMs directly accessible on their surface.

the surface of the material. The interface between microorganisms and CNMs is at the surface of the composite. Thus, it seems unnecessary to include CNMs in the whole material. Different approaches are used to create these composites, some specific methods are used to develop bulk nanocomposites whereas other techniques are designed to simply coat a surface. Fig. 7 and Fig. 8 offer a simple classification of these elaboration methods according to their “bulk” or “surface” nature.

Bulk nanocomposites may be prepared in a very simple way by the solvent casting method (Fig. 7a). Basically, this involves the mixing of a polymer solution with a dispersion of CNMs. The resulting liquid is then poured onto a plate to form the final material after evaporation of the solvent. Depending on the quantity casted onto the plate this method allows to prepare bulk nanocomposites [60,62,182,183] or films [58]. A variation of this technique was used to create a nanocomposite film from a GO/DODA solution (DODA: dimethyldioctadecylammonium) on water. Such a nanocomposite material may find applications in water treatment or solar energy conversion [59].

Another way to fabric a bulk nanocomposite is through the electrospinning method (Fig. 7b). This technology consists in applying an electrical tension on the nozzle of a syringe containing a polymer solution. An opposite voltage is applied onto a collector placed in front. The created electric field causes drops of the polymer solution to stretch and form solid fibres as they travel to the target. This is a simple process allowing the production of few nanometre diameter fibres with large surface area and superior mechanical properties, which may be easily functionalized [192]. This technique was reported in the literature for the production of composite fibres containing CNMs [187,188,193–195]. It was used

for example to produce polylactic acid/CNTs/chitosan nano composite fibres in one step because the CNMs can be included directly in the polymer solution [91,182]. Polymers are selected according to their inherent properties in view of the application. For example, Polyethylene oxide (PEO), Polylactic acid (PLA) or Poly(vinyl alcohol) PVA are easy to process by electrospinning and are thus among the most used polymers to develop electrospun nanofibers [187]. Another method recently developed called 3D printing or additive manufacturing (Fig. 7c) may be considered to prepare bulk nanocomposites [196,197]. In most cases, this fast and accurate technique allows to fabricate objects with any wanted shape. The 3D printer creates the final structure by heating a polymeric mixture and extruding it layer by layer through a nozzle [198]. Different works reported 3D printed composites containing graphene or CNTs in a polymer matrix for biomedical application [199–202]. In most cases tests involved human cells to confirm the biocompatibility, however only a few studies investigated the antimicrobial properties. This was the case in a 2020 study on 3D printed GO/poly(ϵ caprolactone) fibrous scaffolds that evaluated the antibacterial effect of such a material against *S. epidermidis* and *E. coli* [203].

Instead of creating bulk materials, nanocomposites may also be prepared by coating a substrate. This is especially relevant to limit the amount of CNMs, while obtaining the same surface properties. For instance, the spin coating technique (Fig. 8a) consists in dropping the coating solution/suspension onto a rotating substrate. The centrifuge force allows the liquid to form a uniform layer on the substrate, control of rotation speed rate allows an easy control of the film thickness. This technique was described in the literature for the production of CNMs based nanocomposites [54,55]. It was used

Table 1

Examples of composites containing CNMs from articles published between 2008 and 2019. -: no qualitative test (deduction from literature); /: no antimicrobial properties; X: no information.

Bulk composite-Mixing-Direct casting						
Composite	Polymer antimicrobial property	Mechanism	Assay	Application	Microorganisms	Ref
G-PVA (Poly(vinyl alcohol))	/	~Physical damage and/or Oxidative Stress	Colony counting Absorbance (MTT: 3-(4,5-dimethylthiazol-2-yl)-2,5-diphenyltetrazolium bromide)	Biomedical	<i>S. aureus</i> <i>E. coli</i>	[60] 2016
GO-DODA (dimethyldioctadecylammonium)	antibacterial	Not described	Fluorescence (SYTO 9 PI (Propidium iodide)) SEM	Environment (solar harvesting devices) and biomedical	<i>P. aeruginosa</i> <i>E. coli</i>	[81] 2016 [59] 2013
GO-AG (agarose)	/	~Physical damage and Oxidative Stress	Fluorescence (DAPI (4',6-diamidino-2-phénylindole) (PI) SEM	Environment (water purification)	<i>E. coli</i> <i>S. aureus</i>	[81] 2016 [182] 2013
GO-CS (Chitosan)	/	Not described	Fluorescence (SYTO 9 PI)	Food (packaging)	<i>E. coli</i> <i>B. subtilis</i>	[58] 2017
GO-PVP-CS (PVP: Polyvinyl pyrrolidone)	CS: antibacterial (cationic) PVP:/	~Physical damage and Oxidative Stress	Colony counting	Biomedical (wound dressing) Food (packaging)	<i>S. aureus</i> <i>E. coli</i>	[81] 2016 [183] 2016
rGO-epoxy	/	Radical Oxidative Stress	Colony counting	Environment (corrosion protection) Biomedical	<i>E. coli</i>	[213] 2018
MWCNT-CS-derivatives	Improved performance of CS/MWCNT composite compared to CS	Oxidative Stress	Inhibition zone	Biomedical	<i>E. faecalis</i> ; <i>E. coli</i> ; <i>S. epidermidis</i> Fungi: <i>A. niger</i> <i>C. neoformans</i> <i>C. tropicalis</i>	[62] 2018
Bulk composite-Electrospinning						
Composite	Polymer antimicrobial property	Mechanism	Assay	Application	Microorganisms	Ref
GO-CS-PVA	CS: antibacterial PVA:/	Not described	Inhibition zone	Biomedical (wound healing and drug delivery system)	<i>E. coli</i>	[81] 2016 [188] 2014
GO-PVA-CS	CS: antibacterial PVA:/	Not described	Inhibition zone	Biomedical (wound dressing)	<i>E. coli</i> <i>S. aureus</i>	[187] 2018
SWNTs-Psf Psf: Polysulfone	Psf:/	Physical damage	Fluorescence (DAPI PI) SEM	Antibacterial coating	<i>E. coli</i>	[194] 2011
t-MWNT-lignin-PVA	PVA:/ Lignin:/	~ Physical damage	Serial dilution method (Minimum inhibitory concentration; Minimum bactericidal concentration)	Biomedical (Wound dressings, scaffolds, and antimicrobial textile).	<i>S. aureus</i>	[195] 2018
CNTs-CS-PLA	CS: antibacterial PLA:/	PLA/CNTs:/ CS/PLA/CNTs: <i>On bacteria</i> : electrostatic effects <i>On Fungi</i> : aggregation of fungal spores and morphological abnormalities.	Colony counting	Food: (Strawberry preservation)	<i>E. coli</i> <i>S. aureus</i> Fungi: <i>B. cinerea</i> and <i>Rhizopus</i>	[91] 2019
Coating-Spin coating						
Composite	Polymer antimicrobial property	Mechanism	Assay	Application	Microorganisms	Ref
GO-glass hGO-glass (hydrated GO) GO-Silicon	Glass: / Silicon:/	•C radical transfer Physical damage	Colony counting SEM Fluorescence (Bacterial Membrane Lipid Peroxidation) Luminescence (β-Galactosidase Release from Bacteria)	Biomedical (Coatings for medical devices, wound healing, antibacterial additives in dental devices) Environment (water filtration membranes)	<i>E. coli</i> <i>L. crispatus</i>	[54] 2016
GO-PVK (polyvinyl-N-carbazole)	PVK:/	~Physical damage and Oxidative Stress PVK-GO solution: Wrapping isolation	PVK-GO suspension: Fluorescence (SYTO-9 PI (propidium iodide)); Metabolic activity) Colony counting	Biomedical	<i>E. coli</i> , <i>C. metallidurans</i> ; <i>B. subtilis</i> , <i>R. opacus</i>	[214] 2015 [55] 2012

Table 1 (continued)

Bulk composite-Mixing-Direct casting					
Composite	Polymer antimicrobial property	Mechanism	Assay	Application	Microorganisms Ref
SWNT-PLGA (Poly(lactic-co-glycolic acid))	PLGA:/	~Physical damage and Oxidative Stress	SEM OD PVK-GO coating on ITO: Inhibition zone AFM Fluorescence (SYTO 9 DAPI; Metabolic activity) SEM	Biomedical (medical devices)	<i>E. coli</i> <i>S. epidermidis</i> [214] 2015 [52] 2010
Coating-Ball milling Composite					
Composite	Polymer antimicrobial property	Mechanism	Assay	Application	Microorganisms Ref
GO-Alkyd resin	Alkyd resin:/	~Physical damage and/or Oxidative Stress	Colony counting Fluorescence (SYTO 9 and Fouling test	Environment PI) (antifouling properties corrosion and antibacterial resistance)	<i>E. coli</i> <i>S. aureus</i> <i>P. aeruginosa</i> [81] 2016 [205] 2014
Coating-Dip Coating Composite					
Composite	Polymer antimicrobial property	Mechanism	Assay	Application	Microorganisms Ref
GO-silicon hGO-glass	Silicon:/	•C radical transfer Physical damage	Colony Counting Fluorescence (β-Galactosidase Release; Bacterial membrane lipid peroxidation) SEM	Biomedical (Medical devices; wound healing, antibacterial additives in dental devices) Environment (water filtration membranes)	<i>E. coli</i> <i>L. crispatus</i> [54] 2016
GO-silicon rubber	Silicon:/	Oxidative Stress	Colonies counting Fluorescence (AO (Acridine orange) PI) SEM	Biomedical (medical instruments)	<i>E. coli</i> <i>S. aureus</i> [180] 2018
SWNT-PVK;	PVK:/ (Improvement of SWNTs dispersion in the presence of PVK enhances performances)	~Physical damage and Oxidative Stress	Fluorescence (SYTO 9 PI) OD (DNA quantification) Colony counting Inhibition Zone SEM	Environmental (Water purification)	<i>E. coli</i> <i>B. subtilis</i> [214] 2015 [181] 2013
Coating-Vacuum filtration Composite					
Composite	Polymer antimicrobial property	Mechanism	Assay	Application	Microorganisms Ref
GO-PVK G-PVK	PVK:/ (Improvement of GO/G dispersion in the presence of PVK enhances performances)	~Physical damage and Oxidative Stress	Regrow Assay of Bacteria Retained on the Filter SEM Colony counting Fluorescence (Metabolic assay) Absorbance (Reactive Oxygen Species Assay; DNA release)	Environmental (Water treatment)	<i>E. coli</i> <i>B. subtilis</i> [81] 2016 [49] 2014
SWNT-PVDF (Poly(vinylidene fluoride))	PVDF:/	Physical damage	Fluorescence (SYTO 9 PI; Metabolic activity assay) SEM	Environmental: (treatment of contaminated water)	<i>E.coli</i> Model virus particle: MS2 bacteriophage [214] 2015 [51] 2008
Coating-Electrodeposition					
Composite	Polymer antimicrobial property	Mechanism	Assay	Application	Microorganisms Ref
G-PVK	PVK:/ (Improvement of G dispersion in the presence of PVK enhances performances)	~Physical damage and Oxidative Stress	Composite in solution: OD; Fluorescence (SYTO 9 PI; Metabolic activity assay) Composite films: AFM (Biofilm measurement)	Biomedical	<i>B. subtilis</i> <i>E. coli</i> [214] 2015 [48] 2012
GO-PVK	PVK:/ (Improvement of GO dispersion in the presence	Not described	Composite in solution: OD Deposit on ITO: Fluorescence (SYTO 9 PI)	Biomedical	<i>E. coli</i> [81] 2016 [47] 2011

(continued on next page)

Table 1 (continued)

Bulk composite-Mixing-Direct casting						
Composite	Polymer antimicrobial property	Mechanism	Assay	Application	Microorganisms	Ref
	of PVK enhances performances)					
Film-Vacuum filtration Composite						
Composite	Polymer antimicrobial property	Mechanism	Assay	Application	Microorganisms	Ref
GO PEI/BC (PEI: Polyethyleneimine; BC: bacterial cellulose)	/	~Physical damage; Wrapping isolation and electrostatic interaction	Colony counting Fluorescence (PI) SEM	X	<i>S. aureus</i> <i>S. cerevisiae</i>	[81] 2016 [204] 2016
rGO-TWEEN 20 (Polyoxyethylene(20) sorbitan monolaurate)	TWEEN:/	Non-binding Not described	Optical microscope Fluorescence (Calcein PI)	Biomedical	<i>B. cereus</i>	[214] 2015 [82] 2010
Surface functionalization-Electrodeposition Composite						
Composite	Polymer antimicrobial property	Mechanism	Assay	Application	Microorganisms	Ref
GO-Steel rGO-Steel	Steel:/	~Physical damage	Colony Counting Spectrophotometry (RNA efflux Measurement)	X	<i>E. coli</i> <i>S. aureus</i>	[215] 2018 [87] 2010
Surface functionalization-Electrospraying Composite						
Composite	Polymer antimicrobial property	Mechanism	Assay	Application	Microorganisms	Ref
GO-PCU (Polycarbonate urethane)	PCU:/	~Physical damage and Oxidative Stress	Inhibition zone Absorbance (MTT assay) Colony counting	Biomedical	<i>S. aureus</i> <i>P. aeruginosa</i>	[46] 2017
Surface functionalization-Layer by layer Composite						
Composite	Polymer antimicrobial property	Mechanism	Assay	Application	Microorganisms	Ref
GO-MPPM (modified macroporous polypropylene Membrane)	PP (Polypropylene):/	~Physical damage	Colony counting	Environment	<i>E. coli</i>	[81] 2016 [209] 2015
GO-PLL hybrid thin film composite PLL: Poly(L-lysine)	PLL:/	PLL electrostatic interaction GO Physical damage and Radical Oxidative Stress	Luminescence (ATP (Adenosine Tri Phosphate) test)	Environment (Filtration)	Water from a local Australian lake	[81] 2016 [53] 2015
SWNT-PLL-PGA PGA: Poly(L-glutamic acid) SWNT polyelectrolyte films	PLL-PGA:/	~Physical damage and Oxidative Stress	Fluorescence (SYTO 9 PI)	Biomedical	<i>E. coli</i> <i>S. epidermidis</i>	[214] 2015 [208] 2012
Surface functionalization-ATRP Composite						
Composite	Polymer antimicrobial property	Mechanism	Assay	Application	Microorganisms	Ref
CNTs-PDMAEMA PDMAEMA: Poly[2-(dimethylamino)ethyl methacrylate];	PDMAEMA: antibacterial (Electrostatic interactions)	CNTs allow mechanical reinforcement, electrical conductivity and antibacterial effects Polymer diffusion	SEM Colony counting	X	<i>E. coli</i> <i>S. aureus</i>	[210] 2013

to cast a drop of a PLGA SWNT solution (PLGA: Poly(lactic co glycolic acid)) on a rotating cleaned glass substrate to coat it with the corresponding nanocomposite film [52]. Spin coating is a very simple, fast, and effective technique when only one side of a material needs to be modified.

Dip coating (Fig. 8b) is another common coating method used for the fabrication of CNMs based nanocomposites [54,180], where the substrate is immersed into a coating material solution/suspension and retrieved at controlled speed. PVK SWNT coated nitrocellulose membranes were prepared using this strategy [181]. Contrary to spin coating, this process is relatively slow, with only limited control of the film thickness. However, it makes possible to cover the whole surface of a substrate in a single step.

Vacuum filtration (Fig. 8c) was also mentioned in the literature

as a membrane coating method. The substrate is fixed as a filter on a vacuum filtration setup, then the coating suspension is poured onto the substrate and the coating process finally takes place during its filtration. SWNT/PVDF (PVDF: Poly(vinylidene fluoride)) microporous membranes were successfully obtained by this technique [51]. Furthermore, the vacuum filtration also allows to prepare nanocomposite films, for example to filter a GO PEI/BC (PEI: Polyethyleneimine; BC: bacterial cellulose) dispersion in order to obtain free standing disc like films instead of considering the filter as the final substrate [204]. This method was also used to prepare a free standing paper composed of Tween 20 (Tween 20: Polyoxyethylene(20) sorbitan monolaurate) and rGO. Similarly to dip coating, vacuum filtration is rather slow and does not offer a very accurate control of the homogeneity and film thickness [82].

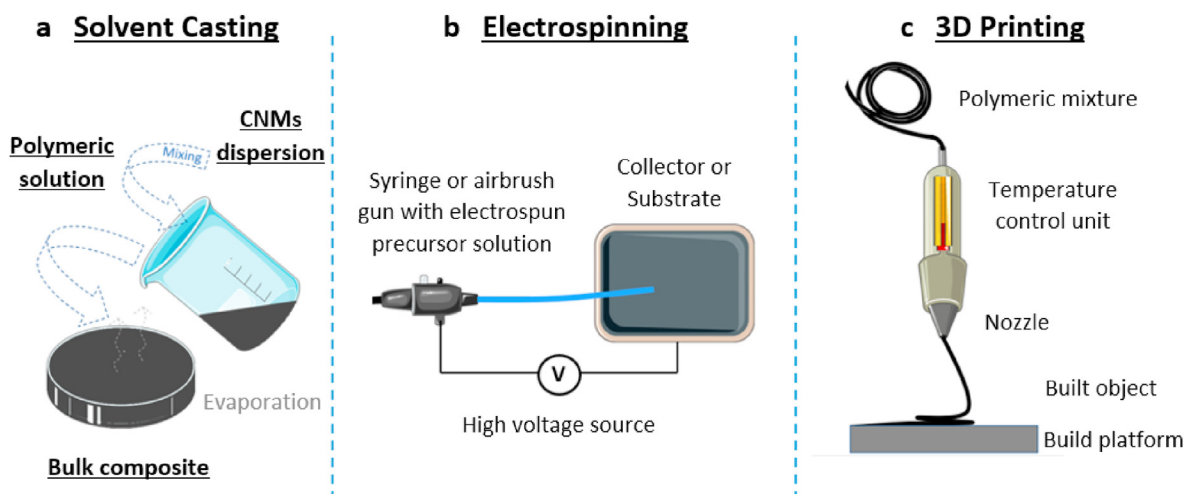

Fig. 7. Schematic illustration of bulk composite elaboration a) Solvent casting; b) Electrospinning; c) 3D printing. (A colour version of this figure can be viewed online.)

A nanopaint designed to coat a material may be prepared by simply mixing components together. For instance a GO nanopaint exhibiting both antibacterial and antifouling properties was fabricated via the ball milling technology [205]. This method involves a bowl containing the components and grinding balls. It is an easy way to mix materials together, however a major disadvantage is the possible incorporation of impurities from the bowl and/or the balls [206].

Another method to coat a substrate is through electrophoretic deposition (EDP) (Fig. 8d). This technique involves the attachment

of suspended charged particles onto an opposite charged surface through the influence of an electric field. This presents several advantages such as good surface homogeneity and easy control of the film thickness. This technique was used to immobilize a PVK GO composite onto an indium tin oxide (ITO) substrate [47]. This technique may also be considered to simply deposit particles onto materials surface. It was used to deposit graphene onto stainless steel [87].

The Electro spraying method (Fig. 8e) is another technique which can be considered as a variation of the electrospinning

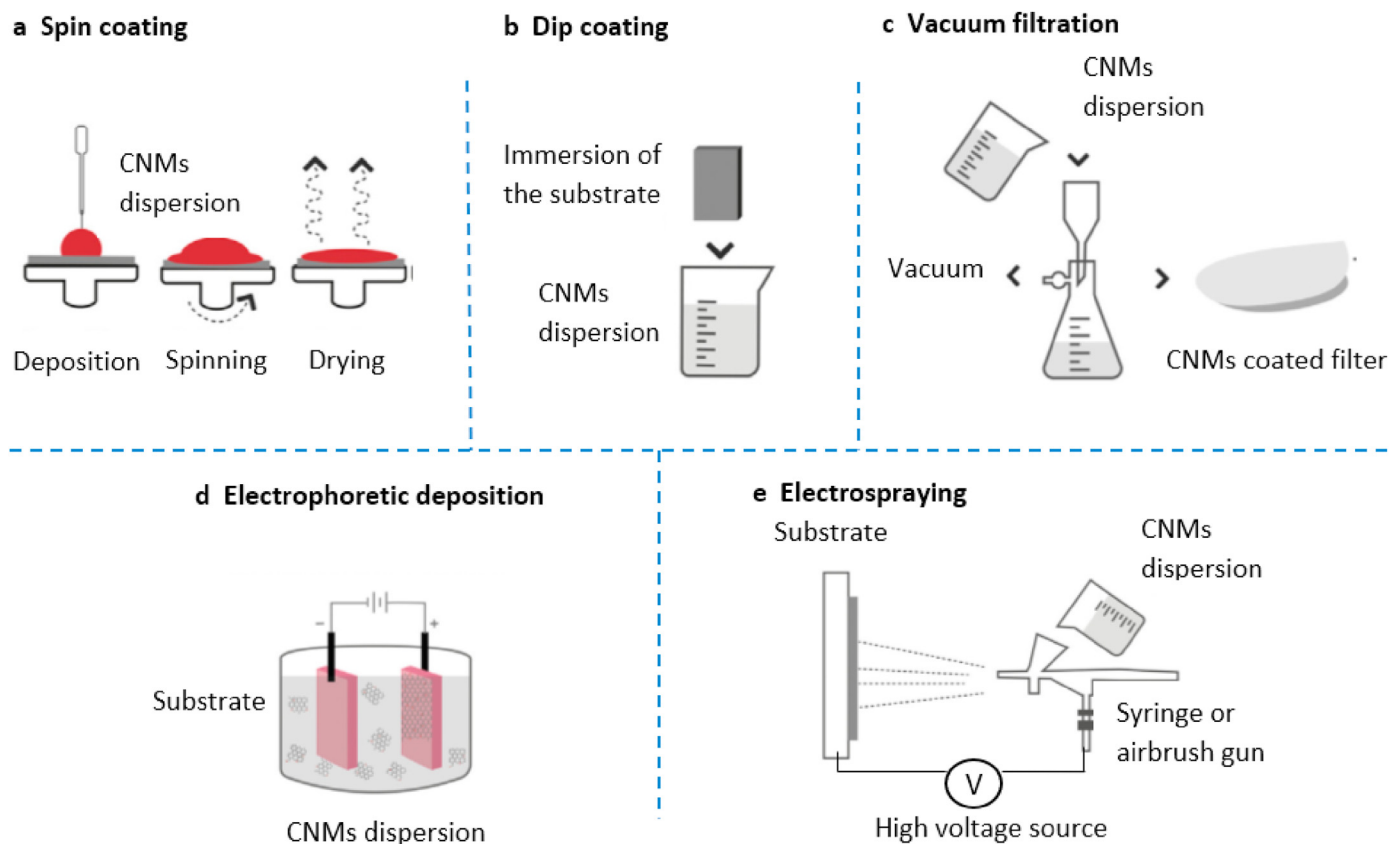

Fig. 8. Schematic illustration of surface nanocomposite elaboration a) Spin coating; b) Dip coating; c) Vacuum filtration; d) Electrophoretic deposition; e) Electro spraying. Adapted from Ref. [207]. (A colour version of this figure can be viewed online.)

method, but the electrical tension applied on the liquid contained in the syringe results in the emission of small droplets on the target instead of fibres. This method allowed the preparation of GO thin films wrapped onto electrospun fibroporous polycarbonate urethane to create a membrane that may be used for future biomedical application [46].

Other strategies have also been described, such as layer by layer assembly (LbL) which involves electrostatic interactions [217,218] and atom transfer radical polymerisation ATRP [210] to graft CNMs onto a material and form a stable modified surface.

Surface coating methods are very relevant as they allow the presence of nanoparticles only on the surface of the material, which is determinant to enable a direct interaction between particles and microorganisms in term of antibacterial activity. This is generally difficult to achieve with bulk fabrication techniques as particles are often enclosed into the polymeric matrix thus not directly available at the surface. Table 1 presents different examples of composites containing CNMs from articles published between 2008 and 2019. For each example, it details the fabrication technique, if the matrix has an intrinsic antimicrobial effect, if the antimicrobial mechanism of the composite is known, the antimicrobial assay used and microorganism tested, and finally the proposed application. It may be noticed that most studies related the biocidal activity to direct contact between carbon nanoparticles and microorganisms. Therefore, it is especially important to prepare composites with particles at the surface. It would then be advantageous to find techniques able to bring the particles to the surface even if they are initially embedded within a polymer matrix. A UV/O₃ oxidation treatment on GO nanosheets that allowed to etch away the surface polymer (2 hydroxyethyl methacrylate (HEMA)) and make possible a direct access to the nanoparticles was reported [211]. Furthermore, laser ablation was chosen in order to resurface GO particles embedded in an agarose matrix [212]. The laser impulse induced liquefaction and matter transport that allowed the cleaning of the nanoparticles. However, there is no extended research on this area yet and it must be emphasized that the actual demonstration of the absence of a very thin layer of polymer at the surface of the carbon nanomaterials is challenging to perform. The general ideas introduced here, with a classification of these different methods, are summarized on Fig. 6. Methods that may be used to prepare composites with nanoparticles on the surface are regrouped and framed.

The classification of the nanocomposite's elaboration methods available in the literature and provided in this section may allow the reader to select the most suitable method for a particular application. Composites may be elaborated on a large scale via the techniques presented in this section as they are already used in the industry. This is the case for spin coating [216,217]; dip coating [218]; vacuum filtration [219]; electrophoretic deposition [220] and electro spinning [221]. Furthermore, access to large amounts of CNMs has become easier thanks to enhanced production performances. This is especially the case of CNTs, with the development of an easier production and prices that keep lowering [222]. Graphene (or more realistically few or multi layer graphene) is still harder to obtain but we may expect a similar evolution in terms of availability within the next years.

As already mentioned, the interface between microorganisms and CNMs is at the surface of the composite. It thus seems unnecessary to include CNMs in the bulk, and materials with CNMs only at the surface seem more promising for antimicrobial applications with an enhanced activity and a lower cost. Surface coating methods are thus very relevant as they allow the presence of nanoparticles only at the material surface, which is determinant to enable a direct interaction between particles and microorganisms in term of antibacterial activity.

Furthermore, techniques able to specifically remove the top polymer layer on the surface of a material may be used to make particles available at the surface (even if they were initially embedded in a polymer matrix) are very interesting. This area of research is not very developed yet, but surface treatments such as laser ablation, plasma or UV/O₃ oxidation processes are already available and may be used to achieve this goal. The industrial development of Carbon nanomaterials based polymer matrix nanocomposites for antimicrobial applications is thus entirely conceivable. In conclusion, there is a wide choice of different techniques and the most appropriate one may be selected depending on technical limitations. The question of the strength of the interaction between CNMs and the surface is very important both in terms of durability of the antimicrobial effect and the limitation of the release of the CNMs that would raise issues of potential toxicity.

5.3. Interaction between the components

We discuss here the different possible interactions between CNMs and a polymer matrix, in the context of the safety (no release) but also durability (longer efficacy) for antimicrobial applications. In a nanocomposite, different interactions occur between CNMs and the polymeric matrix, depending on the physicochemical properties of both components, such as the carbon nanoparticles oxidation state, or the polarity of the polymer for instance. Chemical interactions between components can be created, however physical ones are often enough to prepare a composite and many studies report only physical interactions between particles and the matrix to explain the formation of the nanocomposite. GO-poly(amide) thin film composite membranes were produced and the FTIR analysis suggested that the particles were only embedded in the matrix because no strong chemical binding was evidenced between the components [190]. Aslan et al. also reported the incorporation of SWNTs into a PLGA matrix, where their FTIR characterization suggested that not all SWNT were embedded in the polymer [52]. Other works also described weak interactions between CNMs and a polymeric matrix. For example, interactions between the pi bonds of multi walled carbon nanotubes sidewalls and chemically modified chitosan derivatives were reported to ensure a homogeneous dispersion of the particles inside the matrix [62]. Literature also reported interactions such as hydrogen bonding between the particles and the matrix [60,182]. Hydrogen bonds between oxygen containing groups on the surface of GO and the hydroxyl groups of an epoxy matrix were identified through FTIR characterization [213]. It is also possible to find hydrogen bonding between two polymers forming the matrix [91]. For instance hydrogen bonds between the chitosan and PLA (Polylactic acid) chains in a GO PVA CS composite were reported [187]. Furthermore the reported electrostatic interactions in the case of rGO DODA allowed to avoid any possible leak from the nanocomposite [59]. Multiple interactions were also reported, such as the combination of electrostatic and hydrogen bonding interactions between GO sheets and lipid molecules present in alkyd resin, allowing the formation of GO nanopaint [205]. Covalent bonding was also mentioned [54]. The formation of covalent bonds between GO and chitosan were identified, a crosslinking reaction through nucleophilic addition taking place with the reaction between the epoxy groups in GO and the amino and primary hydroxyl groups in chitosan. This reaction is rather easy and leads to strong binding, improving the mechanical properties of the GO chitosan films [58].

The type of interaction occurring between the components is of great importance as it may cause stability differences between nanocomposites. As introduced previously, the control of nanoparticles toxicity is a major issue. Numerous studies have been

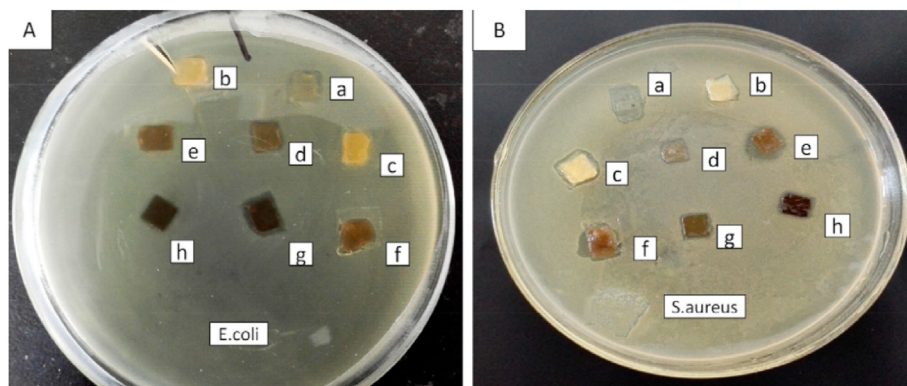

Fig. 9. Picture of inhibition zones of composite nanofibrous membranes in various ratios of CS/PVA/GO: a) CS:PVA:GO 1:9:0; b) CS:PVA:GO 2:8:0; c) CS:PVA:GO 3:7:0; d) CS:PVA:GO 1:9:0.01; e) CS:PVA:GO 2:8:0.02; f) CS:PVA:GO 3:7:0.03; g) CS:PVA:GO 1:9:0.03; h) CS:PVA:GO 1:9:0.05, against *E. coli* (A) and *S. aureus* (B). Reprinted with permission from Ref. [187]. (A colour version of this figure can be viewed online.)

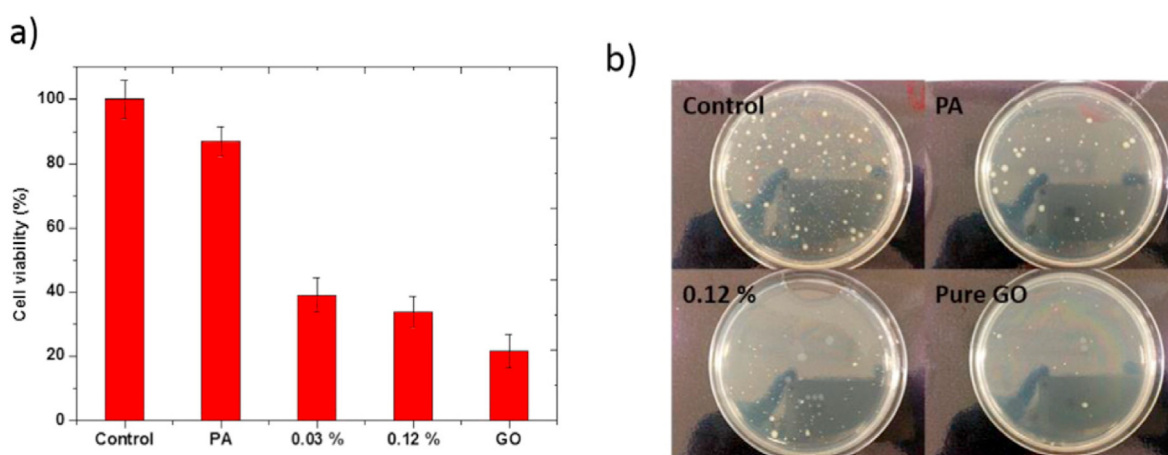

Fig. 10. a) Cell viability measurement after incubation with control, PA, 0.03w.%, 0.12w.% GO poly(amide) membrane and pure GO membrane; b) bacteria grown on agar plates for colony counting. Reprinted with permission from Ref. [190]. (A colour version of this figure can be viewed online.)

conducted on the potential toxicity of CNMs and, if it is still difficult to draw general conclusions, avoiding their release has become a priority. The safer by design strategy aims to benefit from the antimicrobial properties of CNMs into a nanocomposite while avoiding issues related to their release and potential toxicity. Literature reports different stabilities of composites (absence of release of CNMs) depending on the interactions between their components. For instance, differences in terms of stability between a hydrated GO spin coated film and a hydrated GO covalently bonded film were observed. The strong covalent binding appeared to be more durable than the spin coated film with the ability to withstand 30 min under sonication, whereas the spin coated film was only able to resist a few scratches or washings [54].

Strong chemical interactions are thus preferred. In addition, works presenting physical embedment of the CNMs also exhibiting good stability with a durable composite without release of the nanoparticles are also available [190]. It may then be concluded that a combination between strong chemical and physical interactions is the safest way to produce a durable and efficient nanocomposite for antimicrobial applications.

However, it is very difficult to assess with certainty the release of carbon nanoparticles from a composite as carbon is present everywhere and the issue concerns the detection of very small quantities of CNMs [223]. This makes it difficult to compare carbon nanoparticles based antimicrobial composite durability in terms of

particles release in expected conditions of use. It is essential to extend research on these topics, as even without environmental and toxicity issues, the loss of carbon nanoparticles would question the durability of the device activity as in most cases the antimicrobial activity of carbon nanoparticles based composites is directly linked to the action of the nanoparticles themselves. It is essential to ensure the proper holding of the nanoparticles by the matrix to achieve the safer by design strategy, where devices present durable antimicrobial activity with low risks concerning toxicity and environmental impact. This also means that the type of matrix used must be selected carefully, because for example a biodegradable matrix will inevitably lead to the release of the particles with time. Due to the technical challenge related to the identification of negligible losses of CNMs in potentially complex environments during the expected conditions of use, it is recommended to challenge the nanocomposites in harsh conditions (ultrasonication, temperature well above the maximum operation one, low or high pH, etc.) which may allow to certify that the nanocomposites should be used safely in normal conditions.

5.4. Antimicrobial properties of composites

Antimicrobial activity of the materials is assessed through qualitative or quantitative tests based on the analysis of materials impact on the proliferation of microorganisms upon contact

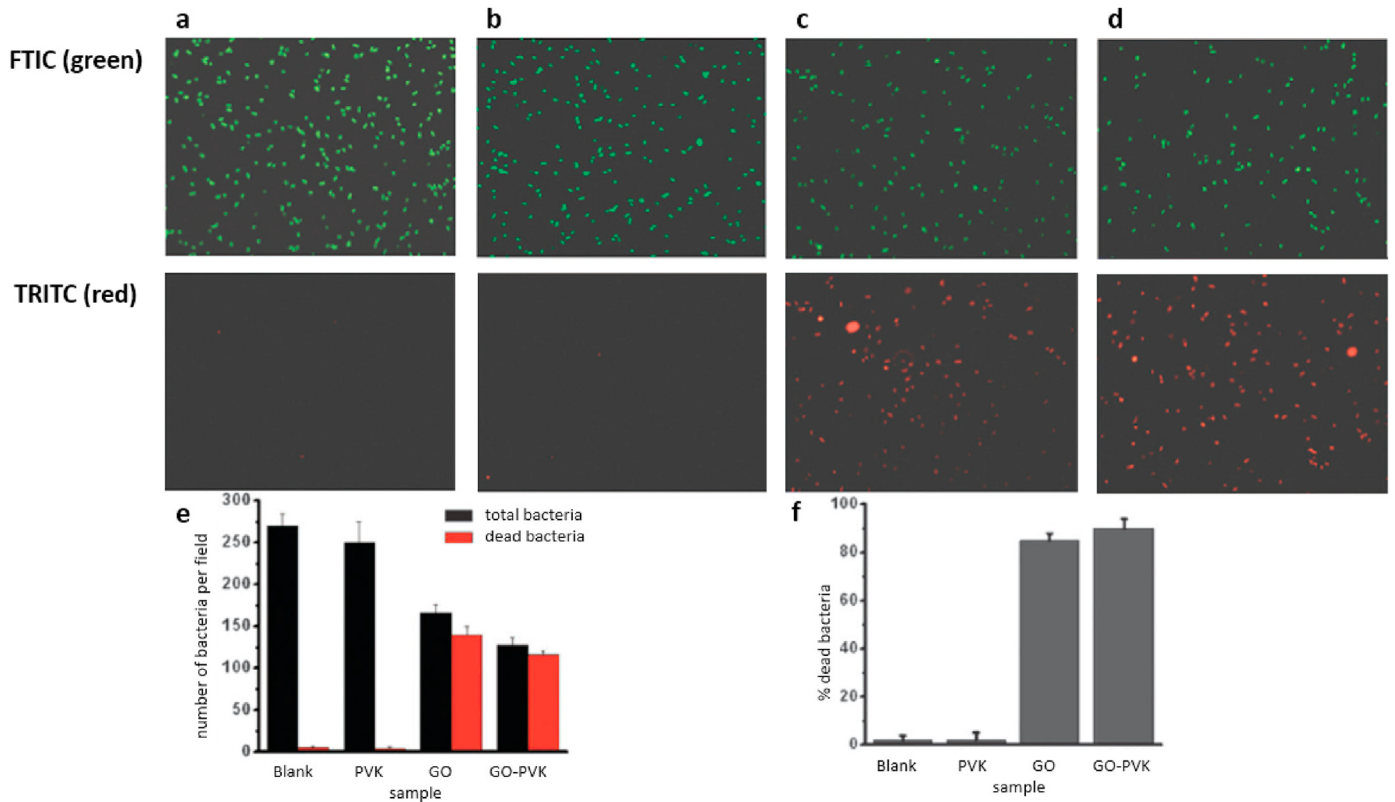

Fig. 11. a–d: Fluorescence images of the *E. coli* on a) unmodified ITO; b) electrodeposited PVK; c) spin-coated GO; and d) electrodeposited PVK-GO films. Images were obtained with a 100× oil immersion objective using a FITC filter for green fluorescence from SYTO 9 in all bacteria presented on the left column and a TRITC filter for red fluorescence from PI in membrane-compromised bacteria presented on the right column. e) Plot of the total number of bacteria (green) and among them the number of PI-positive bacteria (red) on the field of view ($90 \times 70 \mu\text{m}^2$), which were adsorbed on the modified surfaces. The blank is the unmodified ITO substrate as the control. f) Correlation of the % non-viable *E. coli* (% PI-positive) attached on each of the surfaces. Adapted from Ref. [47]. (A colour version of this figure can be viewed online.)

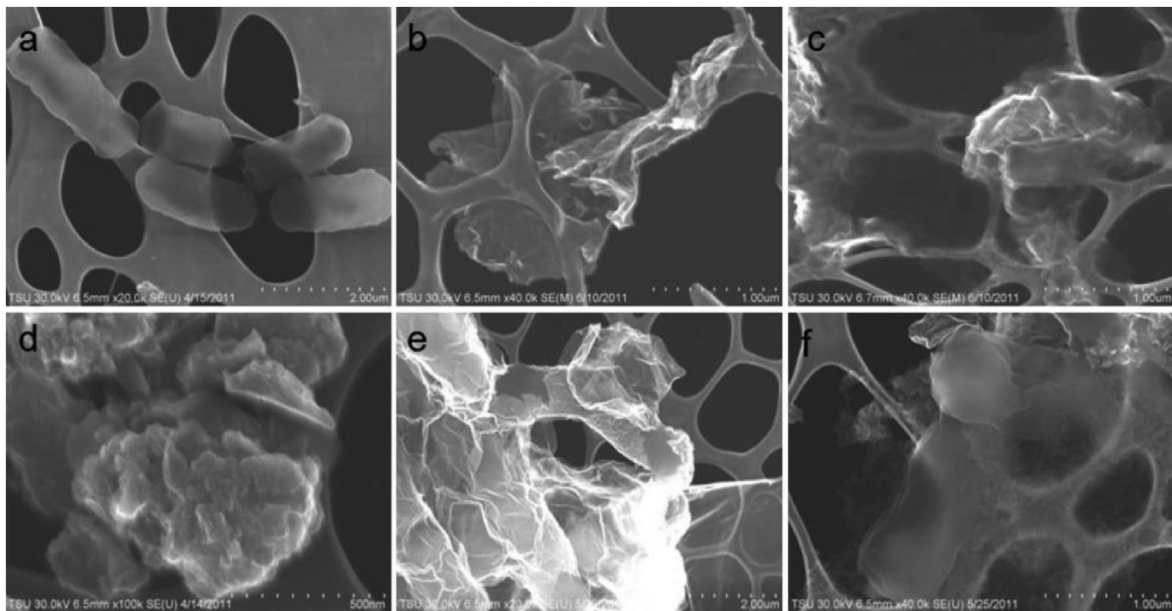

Fig. 12. SEM images of the nanomaterials and *B. subtilis* after interacting with the nanomaterials GO and PVK-GO. a) *B. subtilis* at 20k magnification; b) GO at 40k magnification; c) PVK-GO at 40k magnification; d) PVK at 100k magnification; e) *B. subtilis* exposed to GO at 20k magnification; and f) *B. subtilis* exposed to PVK-GO at 20k magnification. Reprinted with permission from Ref. [53].

((diffusion or dilution methods, colony counting). The different antimicrobial assays presented in part 1 are easily adaptable with

nanocomposites, therefore many studies use popular tools such as the inhibition zone assay, the colony counting assay, the

fluorescence assay and microscopy imaging. For instance, the inhibition zone assay presented in part 1 was used to demonstrate the antimicrobial activity of CS/PVA/GO composites (Fig. 9) [187].

The colony counting method was also adapted to assess the antimicrobial activity of GO poly(amide) membranes with the measurement of cell viability after incubation with the samples (Fig. 10) [190].

Literature also describes the adaptation of the fluorescence assay to measure the antimicrobial activity of a nanocomposite, this may be illustrated with Fig. 11 showing fluorescence images of PVK GO films [47]. This technique can only be applied in the case of transparent thin films.

Scanning electron microscopy (SEM) is a common method of characterization that allows the visualisation of the surface morphology of materials in contact with microorganisms. SEM imaging was used to visualise the interaction between a PVK GO composite and *B. subtilis* bacteria (Fig. 12) [55].

As listed in Table 1, other assays may be used with CNM containing nanocomposites, such as the DNA release assay, Reactive oxygen species assay, etc. Furthermore, these tools may even be used to identify the component of the nanocomposite which is responsible for the antimicrobial activity.

By testing separately the polymer (matrix), the CNMs and finally the nanocomposites and comparing the results, it is possible to attribute the antimicrobial activity to a particular component. For instance, an inert polypropylene membrane with an increased antimicrobial activity upon the incorporation of Graphene materials (GMs) was reported and it was demonstrated that the activity could be attributed to direct contact between graphene and microorganisms [209].

The antimicrobial activity of most CNM containing composites may be attributed to the carbon nanomaterials themselves. They may play either an active role by directly killing/damaging the pathogens, or a passive role if they prevent the adhesion of pathogens at the surface (without killing them). In most cases, the matrix alone does not exhibit antimicrobial properties while the nanocomposite does [182,190]. Indeed, even if the matrix does not have an intrinsic antimicrobial effect, it may enhance the activity of the CNMs by improving their dispersion within the matrix [49]. Literature often concludes to a transfer of antimicrobial properties from isolated CNMs to the whole material upon their incorporation [209]. The combination of the antimicrobial properties of CNMs and the polymer was also reported, such as in the case of CS PVP GO nanocomposites where both GO and chitosan exhibited an antimicrobial activity [183].

Different scenarios are thus possible, yet literature usually concludes that CNMs are responsible for the antimicrobial activity of the nanocomposite and that their properties are transferred to the whole material. The situation of GO which may be reduced by bacteria [61,115,224–227] requires some specific attention, especially if this leads to a loss in terms of antimicrobial activity, thus questioning the durability of the action with time.

As seen in part 2, it is possible to assess the global antimicrobial efficiency of nanocomposite materials thanks to assays that may also be used for CNMs in suspension, however this does not mean that the exact antimicrobial mechanisms can be easily determined. Some antimicrobial mechanisms presented in section 2 (Fig. 4) that are specific to CNMs in suspension may be ruled out to describe what occurs in the case of nanocomposites. As the nanoparticles are immobilized/entrapped within a matrix, the wrapping mechanism where a particle wraps itself around a microorganism and blocks its access to nutrients cannot be considered. Mechanisms involving

the internalisation of CNMs should also be ruled out. Furthermore, local heating is likely not to occur in the case of thermal insulating polymers. However, physical action is still possible (membrane damaging, oxidative stress but also antifouling activity), and especially if the CNMs are easily accessible at the surface while being safely entrapped, thus making possible to provide unlimited antimicrobial activity because no CNM is released at any time. Action through oxidative stress without physical contact should also be considered, as nanomaterials may themselves produce oxidative species. However, this situation cannot be generalised because this effect strongly depends on the nature of the carbon nanomaterial (as discussed in part 2, fullerenes and carbon nanotubes may also exhibit intrinsic antioxidant properties).

6. Conclusion

Composites incorporating carbon based nanomaterials are promising for antimicrobial applications. This review focused on the activity of carbon nanomaterials (carbon nanotubes and graphene derivatives), incorporated in or at the surface of a polymeric matrix. These types of carbon nanomaterials are still the most frequently investigated in the literature, and we have presented many examples evidencing that their incorporation in a polymer matrix allows to transfer the activity of the particles to a whole material. Most reported polymers are efficient nanoparticle holders, while also demonstrating additional intrinsic antimicrobial properties in some cases. When the antimicrobial properties of the composites are conferred by the carbon nanomaterials, most works link the biocidal activity to direct contact between particles and microorganisms. It is thus important to focus on the surface of materials, which represents the interface between CNMs and microorganisms. This simple observation leads to the conclusion that CNMs present in the bulk are of no use and that producing nanocomposites with nanoparticles at the surface seems to be much more relevant in terms of antimicrobial properties, maximizing the efficacy by localizing the nanoparticles where they are really needed. When blocked at the surface, antimicrobial mechanisms such as the creation of physical damages and subsequent oxidative stress should still be performing. The challenge is then managing to prepare polymeric materials containing carbon nanoparticles exposed at the surface (without being covered by a thin polymeric layer) while making sure that they are safely entrapped, to avoid potential release and related toxicity issues. Processes leading to strong interactions (physical, chemical, or both) with the polymer at the surface should thus be preferred. Among the different CNMs investigated in the literature, GO obviously seems to stand apart, the presence of many oxygen containing functional groups being beneficial for both improving the interface with the polymer matrix and for their intrinsic biocidal activity. However, a possible loss of activity may occur due to the ability of some bacteria to reduce it. There is no doubt that other CNMs such as CNTs, FLG and rGO may find here a favourable field of application not only in the biomedical field, but also in all situations where surfaces should remain free of microbial contamination, such as in the food industry with food packaging or for environmental applications with new filters for air or water purification for example. This is especially motivated by their expected unique unlimited action, because they should neither dissolve nor be released from the surface, thus also complying with the safer by design strategy.

Declaration of competing interest

The authors declare that they have no known competing financial interests or personal relationships that could have appeared to influence the work reported in this paper.

² BioSerenity, <https://www.bioserenity.com/>.

Acknowledgments

No project grant was used to support this research. We may however acknowledge the Ministry of Higher Education, Research and Innovation for funding the PhD grant of Mrs Laure Giraud.

Appendix A. Supplementary data

Supplementary data to this article can be found online at <https://doi.org/10.1016/j.carbon.2021.06.002>.

References

- [1] G. O'Toole, H.B. Kaplan, R. Kolter, biofilm formation as microbial development, *Annu. Rev. Microbiol.* 54 (2000) 49–79.
- [2] F. Ahmed, C.M. Santos, R.A.M.V. Vergara, et al., Antimicrobial applications of electroactive PVK-SWNT nanocomposites, *Environ. Sci. Technol.* 46 (2012) 1804–1810.
- [3] I.B. Beech, Corrosion of technical materials in the presence of biofilms—current understanding and state-of-the-art methods of study, *Int. Biodeterior. Biodegrad.* 53 (2004) 177–183.
- [4] I. Francolini, G. Donelli, Prevention and control of biofilm-based medical-device-related infections, *FEMS Immunol. Med. Microbiol.* 59 (2010) 227–238.
- [5] S. Veerachamy, T. Yarlagadda, G. Manivasagam, et al., Bacterial adherence and biofilm formation on medical implants: a review, *Proc. IME H J. Eng. Med.* 228 (2014) 1083–1099.
- [6] K.-S. Huang, C.-H. Yang, S.-L. Huang, et al., Recent advances in antimicrobial polymers: a mini-review, *Int. J. Mol. Sci.* 17 (2016) 1578.
- [7] F. Siedenbiedel, J.C. Tiller, Antimicrobial polymers in solution and on surfaces: overview and functional principles, *Polymers* 4 (2012) 46–71.
- [8] L. Liu, W. Li, Q. Liu, Recent development of antifouling polymers: structure, evaluation, and biomedical applications in nano/micro-structures, *Wiley Interdiscipl. Rev.: Nanomed. Nanobiotechnol.* 6 (2014) 599–614.
- [9] I. Roca, M. Akova, F. Baquero, et al., The global threat of antimicrobial resistance: science for intervention, *New Microbes New Infect.* 6 (2015) 22–29.
- [10] B.D. Brooks, A.E. Brooks, Therapeutic strategies to combat antibiotic resistance, *Adv. Drug Deliv. Rev.* 78 (2014) 14–27.
- [11] R. Weinstein, Nosocomial infection update, *Emerg. Infect. Dis.* 4 (1998) 416–420.
- [12] M.Y. Vaidya, A.J. McBain, J.A. Butler, et al., Antimicrobial efficacy and synergy of metal ions against *Enterococcus faecium*, *Klebsiella pneumoniae* and *Acinetobacter baumannii* in planktonic and biofilm phenotypes, *Sci. Rep.* 7 (2017) 1–9, 5911.
- [13] A. Zhang, Q. Liu, Y. Lei, et al., Synthesis and antimicrobial activities of acrylamide polymers containing quaternary ammonium salts on bacteria and phytopathogenic fungi, *React. Funct. Polym.* 88 (2015) 39–46.
- [14] F. Zhou, X. Qin, Y. Li, et al., Fluorosilicone multi-block copolymers tethering quaternary ammonium salt groups for antimicrobial purpose, *Appl. Surf. Sci.* 347 (2015) 231–241.
- [15] Y. Liu, C. Leng, B. Chisholm, et al., Surface structures of PDMS incorporated with quaternary ammonium salts designed for antibiofouling and fouling release applications, *Langmuir* 29 (2013) 2897–2905.
- [16] G. Liu, G. Wu, C. Jin, et al., Preparation and antimicrobial activity of terpene-based polyurethane coatings with carbamate group-containing quaternary ammonium salts, *Prog. Org. Coating* 80 (2015) 150–155.
- [17] S. Fernando, T. Gunasekara, J. Holton, Antimicrobial Nanoparticles: applications and mechanisms of action, *Sri Lankan J. Infect. Dis.* 8 (2018) 2–11.
- [18] L. Wang, C. Hu, L. Shao, The antimicrobial activity of nanoparticles: present situation and prospects for the future, *Int. J. Nanomed.* 12 (2017) 1227–1249.
- [19] I. Matai, A. Sachdev, P. Dubey, et al., Antibacterial activity and mechanism of Ag–ZnO nanocomposite on *S. aureus* and GFP-expressing antibiotic resistant *E. coli*, *Colloids Surf. B Biointerfaces* 115 (2014) 359–367.
- [20] W.-R. Li, X.-B. Xie, Q.-S. Shi, et al., Antibacterial activity and mechanism of silver nanoparticles on *Escherichia coli*, *Appl. Microbiol. Biotechnol.* 85 (2010) 1115–1122.
- [21] Q. Xin, H. Shah, A. Nawaz, et al., Antibacterial carbon-based nanomaterials, *Adv. Mater.* 31 (2018) 1–14, 1804838.
- [22] A. Al-Jumaili, S. Alancherry, K. Bazaka, et al., Review on the antimicrobial properties of carbon nanostructures, *Materials* 10 (2017) 1–26, 1066.
- [23] S. Varghese, S. Kuriakose, S. Jose, Antimicrobial activity of carbon nanoparticles isolated from natural sources against pathogenic gram-negative and gram-positive bacteria, *J. Nanosci.* (2013) 1–5, 2013.
- [24] S.M. Dizaj, A. Mennati, S. Jafari, et al., Antimicrobial activity of carbon-based nanoparticles, *Adv. Pharmaceut. Bull.* 5 (2015) 19–23.
- [25] S. Kang, M.S. Mauter, M. Elimelech, Microbial cytotoxicity of carbon-based nanomaterials: implications for river water and wastewater effluent, *Environ. Sci. Technol.* 43 (2009) 2648–2653.
- [26] B. Pant, P. Pokharel, A.P. Tiwari, et al., Characterization and antibacterial properties of aminophenol grafted and Ag NPs decorated graphene nanocomposites, *Ceram. Int.* 41 (2015) 5656–5662.
- [27] T. He, H. Liu, Y. Zhou, et al., Antibacterial effect and proteomic analysis of graphene-based silver nanoparticles on a pathogenic bacterium *Pseudomonas aeruginosa*, *Biometals* 27 (2014) 673–682.
- [28] E. Zanni, E. Bruni, C.R. Chandraiahgari, et al., Evaluation of the antibacterial power and biocompatibility of zinc oxide nanorods decorated graphene nanoplatelets: new perspectives for antibiodeteriorative approaches, *J. Nanobiotechnol.* 15 (2017) 1–12.
- [29] Y.-W. Wang, A. Cao, Y. Jiang, et al., Superior antibacterial activity of zinc oxide/graphene oxide composites originating from high zinc concentration localized around bacteria, *ACS Appl. Mater. Interfaces* 6 (2014) 2791–2798.
- [30] A. Bianco, Graphene: safe or toxic? The two faces of the medal, *Angew. Chem. Int. Ed.* 52 (2013) 4986–4997.
- [31] B. Fadeel, C. Bussy, S. Merino, et al., Safety assessment of graphene-based materials: focus on human health and the environment, *ACS Nano* 12 (2018) 10582–10620.
- [32] A. Nel, T. Xia, L. Madler, et al., Toxic potential of materials at the nanolevel, *Sci. New Series* 311 (2006) 622–627.
- [33] L. Yildirim, N.T.K. Thanh, M. Loizidou, et al., Toxicology and clinical potential of nanoparticles, *Nano Today* 6 (2011) 585–607.
- [34] I. Francolini, G. Donelli, F. Crisante, et al., in: G. Donelli (Ed.), *Antimicrobial Polymers for Anti-biofilm Medical Devices: State-Of-Art and Perspectives. Biofilm-Based Healthcare-Associated Infections*, vol. 831, 2015, pp. 93–117.
- [35] R. Sender, S. Fuchs, R. Milo, Revised estimates for the number of human and bacteria cells in the body, *PLoS Biol.* 14 (2016) 1–14, e1002533.
- [36] R.M. Pelczar, M.J. Pelczar, Microbiology, *Encyclopedia Britannica*, 2020.
- [37] D.L. Hawksworth, Microorganisms, *Glob. Biodivers.* (1992) 47–54.
- [38] T.J. Silhavy, D. Kahne, S. Walker, The bacterial cell envelope, *Cold Spring Harbor Perspect. Biol.* 2 (2010) 1–16, a000414.
- [39] M. Balouiri, M. Sadiki, S.K. Ibsnouda, Methods for in vitro evaluating antimicrobial activity—A review, *J. Pharm. Anal.* 6 (2016) 71–79.
- [40] K. Song, Q. Wu, Y. Qi, et al., Electrospun Nanofibers with Antimicrobial Properties, *Electrospun Nanofibers*, 2017, pp. 551–569.
- [41] G. Khandelwal, R. Kumar, V. Kumar, Antimicrobial activities of graphene polymer nanocomposites, in: *Nanostructured Polymer Composites for Biomedical Applications*, 2019, pp. 429–445.
- [42] Zhang Yang, Zhang, Electrospun chitosan/poly (vinyl alcohol)/graphene oxide nanofibrous membrane with ciprofloxacin antibiotic drug for potential WoundDressing application, *Int. J. Mol. Sci.* 20 (2019) 1–16, 4395.
- [43] L. Elleuch, M. Shaaban, S. Smaoui, et al., Bioactive secondary metabolites from a new terrestrial streptomyces sp. TN262, *Appl. Biochem. Biotechnol.* 162 (2010) 579–593.
- [44] C. Valgas, S.M. de Souza, E.F.A. Smânia, et al., Screening methods to determine antibacterial activity of natural products, *Braz. J. Microbiol.* 38 (2007) 369–380.
- [45] J.H. Jørgensen, M.J. Ferraro, Antimicrobial susceptibility testing: a review of general principles and contemporary practices, *Clin. Infect. Dis.* 49 (2009) 1749–1755.
- [46] S. Thampi, A.M. Nandkumar, V. Muthuvijayan, et al., Differential adhesive and bioactive properties of the polymeric surface coated with graphene oxide thin film, *ACS Appl. Mater. Interfaces* 9 (2017) 4498–4508.
- [47] C.M. Santos, M.C.R. Tria, R.A.M.V. Vergara, et al., Antimicrobial graphene polymer (PVK-GO) nanocomposite films, *Chem. Commun.* 47 (2011) 8892–8894.
- [48] C.M. Santos, J. Mangadlao, F. Ahmed, et al., Graphene nanocomposite for biomedical applications: fabrication, antimicrobial and cytotoxic investigations, *Nanotechnology* 23 (2012) 1–10, 395101.
- [49] Y.L.F. Musico, C.M. Santos, M.L.P. Dalida, et al., Surface modification of membrane filters using graphene and graphene oxide-based nanomaterials for bacterial inactivation and removal, *ACS Sustain. Chem. Eng.* 2 (2014) 1559–1565.
- [50] W. Hu, C. Peng, W. Luo, et al., Graphene-based antibacterial paper, *ACS Nano* 4 (2010) 4317–4323.
- [51] A.S. Brady-Estévez, S. Kang, M. Elimelech, A single-walled-carbon-nanotube filter for removal of viral and bacterial pathogens, *Small* 4 (2008) 481–484.
- [52] S. Aslan, C.Z. Loebick, S. Kang, et al., Antimicrobial biomaterials based on carbon nanotubes dispersed in poly(lactic-co-glycolic acid), *Nanoscale* 2 (2010) 1789–1794.
- [53] H.M. Hegab, A. ElMekawy, T.G. Barclay, et al., Fine-tuning the surface of forward osmosis membranes via grafting graphene oxide: performance patterns and biofouling propensity, *ACS Appl. Mater. Interfaces* 7 (2015) 18004–18016.
- [54] R. Li, N.D. Mansukhani, L.M. Guiney, et al., Identification and optimization of carbon radicals on hydrated graphene oxide for ubiquitous antibacterial coatings, *ACS Nano* 10 (2016) 10966–10980.
- [55] I.E. Mejías Carpio, C.M. Santos, X. Wei, et al., Toxicity of a polymer graphene oxide composite against bacterial planktonic cells, biofilms, and mammalian cells, *Nanoscale* 4 (2012) 4746–4756.
- [56] M. Li, N. Xi, Y. Wang, et al., Advances in atomic force microscopy for single-cell analysis, *Nano Res.* 12 (2019) 703–718.
- [57] T.A. Comesano, M.J. Natan, B.E. Logan, Observation of changes in bacterial cell morphology using tapping mode atomic force microscopy, *Langmuir* 16 (2000) 4563–4572.
- [58] C.D. Grande, J. Mangadlao, J. Fan, et al., Chitosan cross-linked graphene oxide

- nanocomposite films with antimicrobial activity for application in food industry, *Macromol. Symp.* 374 (2017) 1–8, 1600114.
- [59] S. Yin, Y. Goldovsky, M. Herzberg, et al., Functional free-standing graphene honeycomb films, *Adv. Funct. Mater.* 23 (2013) 2972–2978.
- [60] R. Surudžić, A. Janković, M. Mitrić, et al., The effect of graphene loading on mechanical, thermal and biological properties of poly(vinyl alcohol)/graphene nanocomposites, *J. Ind. Eng. Chem.* 34 (2016) 250–257.
- [61] H.M. Hegab, A. ElMekawy, L. Zou, et al., The controversial antibacterial activity of graphene-based materials, *Carbon* 105 (2016) 362–376.
- [62] N.A. Mohamed, N.A. Abd El-Ghany, Novel aminohydrazide cross-linked chitosan filled with multi-walled carbon nanotubes as antimicrobial agents, *Int. J. Biol. Macromol.* 115 (2018) 651–662.
- [63] S. Krishnan, C.J. Weinman, C.K. Ober, Advances in polymers for anti-biofouling surfaces, *J. Mater. Chem.* 18 (2008) 3405–3413.
- [64] Y. Xue, H. Xiao, Y. Zhang, Antimicrobial polymeric materials with quaternary ammonium and phosphonium salts, *Int. J. Mol. Sci.* 16 (2015) 3626–3655.
- [65] N. Kawabata, M. Nishiguchi, Antibacterial activity of soluble pyridinium-type polymers, *Appl. Environ. Microbiol.* 54 (1988) 2532–2535.
- [66] A. Kanazawa, T. Ikeda, T. Endo, Polymeric phosphonium salts as a novel class of cationic biocides. IV. Synthesis and antibacterial activity of polymers with phosphonium salts in the main chain, *J. Polym. Sci. Polym. Chem.* 31 (1993) 3031–3038.
- [67] A. Kanazawa, T. Ikeda, T. Endo, Novel polycationic biocides: synthesis and antibacterial activity of polymeric phosphonium salts, *J. Polym. Sci. Polym. Chem.* 31 (1993) 335–343.
- [68] A. Kanazawa, T. Ikeda, T. Endo, Antibacterial activity of polymeric sulfonium salts, *J. Polym. Sci. Polym. Chem.* 31 (1993) 2873–2876.
- [69] K.E.S. Locock, T.D. Michl, J.D.P. Valentin, et al., Guanlylated polymethacrylates: a class of potent antimicrobial polymers with low hemolytic activity, *Biomacromolecules* 14 (2013) 4021–4031.
- [70] K. Yu, Y. Mei, N. Hadjesfandiari, et al., Engineering biomaterials surfaces to modulate the host response, *Colloids Surf. B Biointerfaces* 124 (2014) 69–79.
- [71] L. Timofeeva, N. Kleshcheva, Antimicrobial polymers: mechanism of action, factors of activity, and applications, *Appl. Microbiol. Biotechnol.* 89 (2011) 475–492.
- [72] T. Bortolamiol, P. Lukanov, A.-M. Galibert, et al., Double-walled carbon nanotubes: quantitative purification assessment, balance between purification and degradation and solution filling as an evidence of opening, *Carbon* 78 (2014) 79–90.
- [73] V. Georgakilas, M. Otyepka, A.B. Bourlinos, et al., Functionalization of graphene: covalent and non-covalent approaches, derivatives and applications, *Chem. Rev.* 112 (2012) 6156–6214.
- [74] O.A. Shenderova, D.M. Gruen, *Ultrananocrystalline Diamond: Synthesis, Properties and Applications*, 2012.
- [75] M. Zeiger, N. Jackel, M. Aslan, et al., Understanding structure and porosity of nanodiamond-derived carbon onions, *Carbon* 84 (2015) 584–598.
- [76] C. Portet, G. Yushin, Y. Gogotsi, Electrochemical performance of carbon onions, nanodiamonds, carbon black and multiwalled nanotubes in electrical double layer capacitors, *Carbon* 45 (2007) 2511–2518.
- [77] J.K. McDonough, A.I. Frolov, V. Presser, et al., Influence of the structure of carbon onions on their electrochemical performance in supercapacitor electrodes, *Carbon* 50 (2012) 3298–3309.
- [78] G.N. Yushin, S. Osswald, V.I. Padalko, et al., Effect of sintering on structure of nanodiamond, *Diam. Relat. Mater.* 14 (2005) 1721–1729.
- [79] V.N. Mochalin, O. Shenderova, D. Ho, et al., The properties and applications of nanodiamonds, *Nat. Nanotechnol.* 7 (2012) 11–23.
- [80] P. Wick, A.E. Louw-Gaume, M. Kucki, et al., Classification framework for graphene-based materials, *Angew. Chem. Int. Ed.* 53 (2014) 7714–7718.
- [81] L. Shi, J. Chen, L. Teng, et al., The antibacterial applications of graphene and its derivatives, *Small* 12 (2016) 4165–4184.
- [82] S. Park, N. Mohanty, J.W. Suk, et al., Biocompatible, robust free-standing paper composed of a TWEEN/graphene composite, *Adv. Mater.* 22 (2010) 1736–1740.
- [83] D.G. Papageorgiou, I.A. Kinloch, R.J. Young, Mechanical properties of graphene and graphene-based nanocomposites, *Prog. Mater. Sci.* 90 (2017) 75–127.
- [84] C.J. Shearer, A.D. Slattery, A.J. Stapleton, et al., Accurate thickness measurement of graphene, *Nanotechnology* 27 (2016), 125704 1:10.
- [85] S. Kang, M. Pinaut, L.D. Pfefferle, et al., Single-walled carbon nanotubes exhibit strong antimicrobial activity, *Langmuir* 23 (2007) 8670–8673.
- [86] M.S. Dresselhaus, G. Dresselhaus, P.C. Eklund, *Science of Fullerenes and Carbon Nanotubes*, 1996.
- [87] O. Akhavan, E. Ghaderi, Toxicity of graphene and graphene oxide nanowalls against bacteria, *ACS Nano* 4 (2010) 5731–5736.
- [88] A. Shvedova, V. Castranova, E. Kisin, et al., Exposure to carbon nanotube material: assessment of nanotube cytotoxicity using human keratinocyte cells, *J. Toxicol. Environ. Health, Part A* 66 (2003) 1909–1926.
- [89] C. Lam, J.T. James, R. McCluskey, et al., A review of carbon nanotube toxicity and assessment of potential occupational and environmental health risks, *Crit. Rev. Toxicol.* 36 (2006) 189–217.
- [90] J. Cheng, E. Flahaut, S.H. Cheng, Effect of carbon nanotubes on developing zebrafish (*Danio rerio*) embryos, *Environ. Toxicol. Chem.* 26 (2007) 708–716.
- [91] Y. Liu, S. Wang, W. Lan, et al., Fabrication of polylactic acid/carbon nanotubes/chitosan composite fibers by electrospinning for strawberry preservation, *Int. J. Biol. Macromol.* 121 (2019) 1329–1336.
- [92] L. García-Hevia, R. Valiente, J.L. Fernández-Luna, et al., Inhibition of cancer cell migration by multiwalled carbon nanotubes, *Adv. Healthcare Mater.* 4 (2015) 1640–1644.
- [93] I.C. Wang, L.A. Tai, D.D. Lee, et al., C₆₀ and Water-Soluble Fullerene Derivatives as Antioxidants against Radical-Initiated Lipid Peroxidation, vol. 42, 1999, pp. 4614–4620.
- [94] R.M. Lucente-Schultz, V.C. Moore, A.D. Leonard, et al., Antioxidant single-walled carbon nanotubes 131 (2009) 3934–3941.
- [95] D. Crouzier, S. Follet, E. Gentilhomme, et al., Carbon nanotubes induce inflammation but decrease the production of reactive oxygen species in lung, *Toxicology* 272 (2010) 39–45.
- [96] H. Zheng, R. Ma, M. Gao, et al., Antibacterial applications of graphene oxides: structure-activity relationships, molecular initiating events and biosafety, *Sci. Bull.* 63 (2018) 133–142.
- [97] W. Han, Z. Wu, Y. Li, et al., Graphene family nanomaterials (GFNs) promising materials for antimicrobial coating and film: a review, *Chem. Eng. J.* 358 (2019) 1022–1037.
- [98] T. Mashino, D. Nishikawa, K. Takahashi, et al., Antibacterial and anti-proliferative activity of cationic fullerene derivatives, *Bioorg. Med. Chem. Lett* 13 (2003) 4395–4397.
- [99] A. Parise, H. Thakor, X. Zhang, Activity inhibition on municipal activated sludge by single-walled carbon nanotubes, *J. Nanoparticle Res.* 16 (2014) 1–9, 2159.
- [100] Y. Li, Y. Liu, Y. Fu, et al., The triggering of apoptosis in macrophages by pristine graphene through the MAPK and TGF-beta signaling pathways, *Biomaterials* 33 (2012) 402–411.
- [101] P. Begum, B. Fugetsu, Induction of cell death by graphene in *Arabidopsis thaliana* (Columbia ecotype) T87 cell suspensions, *J. Hazard Mater.* 260 (2013) 1032–1041.
- [102] Y. Chen, Y. Gao, Y. Chen, et al., Nanomaterials-based photothermal therapy and its potentials in antibacterial treatment, *J. Contr. Release* 328 (2020) 251–262.
- [103] J. Mamouni, Y. Tang, M. Wu, et al., Single-walled carbon nanotubes coupled with near-infrared laser for inactivation of bacterial cells, *J. Nanosci. Nanotechnol.* 11 (2011) 4708–4716.
- [104] M. Shah Nawaz Khan, H.N. Abdelhamid, H.-F. Wu, Near infrared (NIR) laser mediated surface activation of graphene oxide nanoflakes for efficient antibacterial, antifungal and wound healing treatment, *Colloids Surf. B Biointerfaces* 127 (2015) 281–291.
- [105] O. Akhavan, E. Ghaderi, A. Esfandiari, Wrapping bacteria by graphene nanosheets for isolation from environment, reactivation by sonication, and inactivation by near-infrared irradiation, *J. Phys. Chem. B* 115 (2011) 6279–6288.
- [106] T. Ibelli, S. Templeton, N. Levi-Polyachenko, Progress on utilizing hyperthermia for mitigating bacterial infections, *Int. J. Hyperther.* 34 (2018) 144–156.
- [107] S.M. Al-Hakami, A.B. Khalil, T. Laoui, et al., Fast disinfection of *Escherichia coli* bacteria using carbon nanotubes interaction with microwave radiation, 458943, *Bioinorgan. Chem. Appl.* (2013) 1–9, 2013.
- [108] J. Beik, Z. Abed, A. Shakeri-Zadeh, et al., Evaluation of the sonosensitizing properties of nano-graphene oxide in comparison with iron oxide and gold nanoparticles, *Phys. E Low-dimens. Syst. Nanostruct.* 81 (2016) 308–314.
- [109] J. Beik, Z. Abed, A. Ghadimi-Daresajini, et al., Measurements of nanoparticle-enhanced heating from 1MHz ultrasound in solution and in mice bearing CT26 colon tumors, *J. Therm. Biol.* 62 (2016) 84–89.
- [110] D.K. Chatterjee, P. Diagaradjane, S. Krishnan, Nanoparticle-mediated hyperthermia in cancer therapy, *Ther. Deliv.* 2 (2011) 1001–1014.
- [111] V.R. Raphey, T.K. Henna, K.P. Nivitha, et al., Advanced biomedical applications of carbon nanotube, *Mater. Sci. Eng. C* 100 (2019) 616–630.
- [112] S. Kang, M. Herzberg, D.F. Rodrigues, et al., Antibacterial effects of carbon nanotubes: size does matter!, *Langmuir* 24 (2008) 6409–6413.
- [113] I. Malek, C.F. Schaber, T. Heinlein, et al., Vertically aligned multi walled carbon nanotubes prevent biofilm formation of medically relevant bacteria, *J. Mater. Chem. B* 4 (2016) 5228–5235.
- [114] B. Nowack, J.F. Ranville, S. Diamond, et al., Potential scenarios for nanoparticle release and subsequent alteration in the environment: nanoparticle release, *Environ. Toxicol. Chem.* 31 (2012) 50–59.
- [115] X. Zou, L. Zhang, Z. Wang, et al., Mechanisms of the antimicrobial activities of graphene materials, *J. Am. Chem. Soc.* 138 (2016) 2064–2077.
- [116] H. Wigger, B. Nowack, Material-specific properties applied to an environmental risk assessment of engineered nanomaterials implications on grouping and read-across concepts, *Nanotoxicology* 13 (2019) 623–643.
- [117] P. Dubey, I. Matai, S.U. Kumar, et al., Perturbation of cellular mechanistic system by silver nanoparticle toxicity: cytotoxic, genotoxic and epigenetic potentials, *Adv. Colloid Interface Sci.* 221 (2015) 4–21.
- [118] N.X. Dinh, N.V. Quy, T.Q. Huy, et al., Decoration of silver nanoparticles on multiwalled carbon nanotubes: antibacterial mechanism and ultrastructural analysis, *J. Nanomater.* 814379 (2015) 1–11, 2015.
- [119] M. Yousefi, M. Dadashpour, M. Hejazi, et al., Anti-bacterial activity of graphene oxide as a new weapon nanomaterial to combat multidrug-resistance bacteria, *Mater. Sci. Eng. C* 74 (2017) 568–581.
- [120] C. Nie, Y. Yang, C. Cheng, et al., Bioinspired and biocompatible carbon nanotube-Ag nanohybrid coatings for robust antibacterial applications, *Acta Biomater.* 51 (2017) 479–494.
- [121] P. Kovvuru, P.E. Mancilla, A.B. Shirode, et al., Oral ingestion of silver

- nanoparticles induces genomic instability and DNA damage in multiple tissues, *Nanotoxicology* 9 (2015) 162–171.
- [122] Y. Zhou, J. Huang, W. Shi, et al., Ecofriendly and environment-friendly synthesis of size-controlled silver nanoparticles/graphene composites for antimicrobial and SERS actions, *Appl. Surf. Sci.* 457 (2018) 1000–1008.
- [123] A. Lukowiak, A. Kedziora, W. Strek, Antimicrobial graphene family materials: progress, advances, hopes and fears, *Adv. Colloid Interface Sci.* 236 (2016) 101–112.
- [124] G. Gollavelli, C.-C. Chang, Y.-C. Ling, Facile synthesis of smart magnetic graphene for safe drinking water: heavy metal removal and disinfection control, *ACS Sustain. Chem. Eng.* 1 (2013) 462–472.
- [125] S. Panda, T.K. Rout, A.D. Prusty, et al., Electron transfer directed antibacterial properties of graphene oxide on metals, *Adv. Mater.* 30 (2018) 1–10, 1702149.
- [126] J. Li, G. Wang, H. Zhu, et al., Antibacterial activity of large-area monolayer graphene film manipulated by charge transfer, *Sci. Rep.* 4 (2015) 1–8, 4359.
- [127] H. Geng, J. Dai, J. Li, et al., Antibacterial ability and hemocompatibility of graphene functionalized germanium, *Sci. Rep.* 6 (2016) 37474.
- [128] Y.-K. Cheong, M.P. Arce, A. Benito, et al., Synergistic antifungal study of PEGylated graphene oxides and copper nanoparticles against *Candida albicans*, *Nanomaterials* 10 (2020) 1–19, 819.
- [129] C.-H. Deng, J.-L. Gong, G.-M. Zeng, et al., Graphene sponge decorated with copper nanoparticles as a novel bactericidal filter for inactivation of *Escherichia coli*, *Chemosphere* 184 (2017) 347–357.
- [130] Y. Li, D. Yang, J. Cui, Graphene oxide loaded with copper oxide nanoparticles as an antibacterial agent against *Pseudomonas syringae* pv. tomato, *RSC Adv.* 7 (2017) 38853–38860.
- [131] M. Oves, A. Rauf Mohd, M.O. Ansari, et al., Graphene decorated zinc oxide and curcumin to disinfect the methicillin-resistant *Staphylococcus aureus*, *Nanomaterials* 10 (2020) 1–17, 1004.
- [132] L. Zhong, K.-S. Yun, Graphene oxide-modified ZnO particles: synthesis, characterization, and antibacterial properties, *Int. J. Nanomed.* 10 (2015) 79–92.
- [133] M. Sui, L. Zhang, L. Sheng, et al., Synthesis of ZnO coated multi-walled carbon nanotubes and their antibacterial activities, *Sci. Total Environ.* 452 (2013) 148–154.
- [134] T. Kavitha, A.I. Gopalan, K.-P. Lee, et al., Glucose sensing, photocatalytic and antibacterial properties of graphene ZnO nanoparticle hybrids, *Carbon* 50 (2012) 2994–3000.
- [135] H. Chen, Y.Y. He, M.H. Lin, et al., Characterizations of zinc oxide nanorods incorporating a graphene layer as antibacterial nanocomposites on silicon substrates, *Ceram. Int.* 42 (2016) 3424–3428.
- [136] H. Palza, N. Saldias, P. Arriagada, et al., Antibacterial carbon nanotubes by impregnation with copper nanostructures, *J. Miner. Met. Mater. Soc.* 69 (2017) 1319–1324.
- [137] B.-S. Wu, H.N. Abdelhamid, H.-F. Wu, Synthesis and antibacterial activities of graphene decorated with stannous dioxide, *RSC Adv.* 4 (2014) 3708–3717.
- [138] A.N. Mohan, B. Manoj, Surface modified graphene/SnO₂ nanocomposite from carbon black as an efficient disinfectant against *Pseudomonas aeruginosa*, *Mater. Chem. Phys.* 232 (2019) 137–144.
- [139] E. Alsharaeh, Y. Mussa, F. Ahmed, et al., Novel route for the preparation of cobalt oxide nanoparticles/reduced graphene oxide nanocomposites and their antibacterial activities, *Ceram. Int.* 42 (2016) 3407–3410.
- [140] Y. Liu, W. Fan, Z. Xu, et al., Transgenerational effects of reduced graphene oxide modified by Au, Ag, Pd, Fe₃O₄, Co₃O₄ and SnO₂ on two generations of *Daphnia magna*, *Carbon* 122 (2017) 669–679.
- [141] B. Ahmed, A.K. Ojha, A. Singh, et al., Well-controlled in-situ growth of 2D WO₃ rectangular sheets on reduced graphene oxide with strong photocatalytic and antibacterial properties, *J. Hazard Mater.* 347 (2018) 266–278.
- [142] A. Fakhri, M. Najji, Degradation photocatalysis of tetrodotoxin as a poison by gold doped PdO nanoparticles supported on reduced graphene oxide nanocomposites and evaluation of its antibacterial activity, *J. Photochem. Photobiol. B Biol.* 167 (2017) 58–63.
- [143] H. Yi, D. Huang, L. Qin, et al., Selective prepared carbon nanomaterials for advanced photocatalytic application in environmental pollutant treatment and hydrogen production, *Appl. Catal. B Environ.* 239 (2018) 408–424.
- [144] O. Akhavan, E. Ghaderi, Photocatalytic reduction of graphene oxide nano-sheets on TiO₂ thin film for photoinactivation of bacteria in solar light irradiation, *J. Phys. Chem. C* 113 (2009) 20214–20220.
- [145] B. Cao, S. Cao, P. Dong, et al., High antibacterial activity of ultrafine TiO₂/graphene sheets nanocomposites under visible light irradiation, *Mater. Lett.* 93 (2013) 349–352.
- [146] Y.-N. Chang, X.-M. Ou, G.-M. Zeng, et al., Synthesis of magnetic graphene oxide TiO₂ and their antibacterial properties under solar irradiation, *Appl. Surf. Sci.* 343 (2015) 1–10.
- [147] A. Wanag, P. Rokicka, E. Kusiak-Nejman, et al., Antibacterial properties of TiO₂ modified with reduced graphene oxide, *Ecotoxicol. Environ. Saf.* 147 (2018) 788–793.
- [148] L. Karimi, M.E. Yazdanshenas, R. Khajavi, et al., Using graphene/TiO₂ nanocomposite as a new route for preparation of electroconductive, self-cleaning, antibacterial and antifungal cotton fabric without toxicity, *Cellulose* 21 (2014) 3813–3827.
- [149] G.L.-M. Léonard, S. Remy, B. Heinrichs, Doping TiO₂ films with carbon nanotubes to simultaneously optimise antistatic, photocatalytic and superhydrophilic properties, *J. Sol. Gel Sci. Technol.* 79 (2016) 413–425.
- [150] K.R. Reddy, V.G. Gomes, M. Hassan, Carbon functionalized TiO₂ nanofibers for high efficiency photocatalysis, *Mater. Res. Express* 1 (2014) 1–15, 015012.
- [151] O. Akhavan, R. Azimirad, S. Safa, Functionalized carbon nanotubes in ZnO thin films for photoinactivation of bacteria, *Mater. Chem. Phys.* 130 (2011) 598–602.
- [152] A. Nourmohammadi, R. Rahighi, O. Akhavan, et al., Graphene oxide sheets involved in vertically aligned zinc oxide nanowires for visible light photoinactivation of bacteria, *J. Alloys Compd.* 612 (2014) 380–385.
- [153] D. Wu, T. An, G. Li, et al., Mechanistic study of the visible-light-driven photocatalytic inactivation of bacteria by graphene oxide-zinc oxide composite, *Appl. Surf. Sci.* 358 (2015) 137–145.
- [154] P. Gao, J. Liu, D.D. Sun, et al., Graphene oxide CdS composite with high photocatalytic degradation and disinfection activities under visible light irradiation, *J. Hazard Mater.* 250 (2013) 412–420.
- [155] C.-H. Deng, J.-L. Gong, G.-M. Zeng, et al., Graphene CdS nanocomposite inactivation performance toward *Escherichia coli* in the presence of humic acid under visible light irradiation, *Chem. Eng. J.* 284 (2016) 41–53.
- [156] A. Fakhri, D.S. Kahi, Synthesis and characterization of MnS₂/reduced graphene oxide nanohybrids for with photocatalytic and antibacterial activity, *J. Photochem. Photobiol. B Biol.* 166 (2017) 259–263.
- [157] O. Akhavan, M. Choobtashani, E. Ghaderi, Protein degradation and RNA efflux of viruses photocatalyzed by graphene tungsten oxide composite under visible light irradiation, *J. Phys. Chem. C* 116 (2012) 9653–9659.
- [158] C. Hou, H. Quan, Y. Duan, et al., Facile synthesis of water-dispersible Cu₂O nanocrystal reduced graphene oxide hybrid as a promising cancer therapeutic agent, *Nanoscale* 5 (2013) 1227–1232.
- [159] L. Liu, J. Liu, D.D. Sun, Graphene oxide wrapped Ag₃PO₄ composite: towards a highly efficient and stable visible-light-induced photocatalyst for water purification, *Catal. Sci. Technol.* 2 (2012) 2525–2532.
- [160] L. Sun, T. Du, C. Hu, et al., Antibacterial activity of graphene oxide/g-C₃N₄ composite through photocatalytic disinfection under visible light, *ACS Sustain. Chem. Eng.* 5 (2017) 8693–8701.
- [161] T. Huang, L. Zhang, H. Chen, et al., A cross-linking graphene oxide polyethyleneimine hybrid film containing ciprofloxacin: one-step preparation, controlled drug release and antibacterial performance, *J. Mater. Chem. B* 3 (2015) 1605–1611.
- [162] H.N. Abdelhamid, M.S. Khan, H.-F. Wu, Graphene oxide as a nanocarrier for gramicidin (GOGD) for high antibacterial performance, *RSC Adv.* 4 (2014) 50035–50046.
- [163] H.Z. Zardini, A. Amiri, M. Shanbedi, et al., Enhanced antibacterial activity of amino acids-functionalized multi-walled carbon nanotubes by a simple method, *Colloids Surf. B Biointerfaces* 92 (2012) 196–202.
- [164] R.K. Mishra, E. Segal, A. Lipovsky, et al., New life for an old antibiotic, *ACS Appl. Mater. Interfaces* 7 (2015) 7324–7333.
- [165] A. Amiri, H.Z. Zardini, M. Shanbedi, et al., Efficient method for functionalization of carbon nanotubes by lysine and improved antimicrobial activity and water-dispersion, *Mater. Lett.* 72 (2012) 153–156.
- [166] M. Assali, A.N. Zaid, F. Abdallah, et al., Single-walled carbon nanotubes-ciprofloxacin nanoantibiotic: strategy to improve ciprofloxacin antibacterial activity, *Int. J. Nanomed.* 12 (2017) 6647–6659.
- [167] B. Yuan, T. Zhu, Z. Zhang, et al., Self-assembly of multilayered functional films based on graphene oxide sheets for controlled release, *J. Mater. Chem.* 21 (2011) 3471–3476.
- [168] M. Ashfaq, N. Verma, S. Khan, Copper/zinc bimetal nanoparticles-dispersed carbon nanofibers: a novel potential antibiotic material, *Mater. Sci. Eng. C* 59 (2016) 938–947.
- [169] A. Ahmad, A.S. qureshi, L. Li, et al., Antibacterial activity of graphene supported FeAg bimetallic nanocomposites, *Colloids Surf. B Biointerfaces* 143 (2016) 490–498.
- [170] N. Gao, Y. Chen, J. Jiang, Ag@Fe₂O₃-GO nanocomposites prepared by a phase transfer method with long-term antibacterial property, *ACS Appl. Mater. Interfaces* 5 (2013) 11307–11314.
- [171] A. Perdikaki, A. Galeou, G. Pilatos, et al., Ag and Cu monometallic and Ag/Cu bimetallic nanoparticle-graphene composites with enhanced antibacterial performance, *ACS Appl. Mater. Interfaces* 8 (2016) 27498–27510.
- [172] L. Liu, H. Bai, J. Liu, et al., Multifunctional graphene oxide-TiO₂-Ag nanocomposites for high performance water disinfection and decontamination under solar irradiation, *J. Hazard Mater.* 261 (2013) 214–223.
- [173] W. Xu, W. Xie, X. Huang, et al., The graphene oxide and chitosan biopolymer loads TiO₂ for antibacterial and preservative research, *Food Chem.* 221 (2017) 267–277.
- [174] X. Yang, J. Qin, Y. Jiang, et al., Bifunctional TiO₂/Ag₃PO₄/graphene composites with superior visible light photocatalytic performance and synergistic inactivation of bacteria, *RSC Adv.* 4 (2014) 18627–18636.
- [175] A. Payan, A. Akbar Isari, N. Gholizade, Catalytic decomposition of sulfamethazine antibiotic and pharmaceutical wastewater using Cu-TiO₂@functionalized SWCNT ternary porous nanocomposite: influential factors, mechanism, and pathway studies, *Chem. Eng. J.* 361 (2019) 1121–1141.
- [176] B. Marta, M. Potara, M. Iliut, et al., Designing chitosan silver nanoparticles-graphene oxide nanohybrids with enhanced antibacterial activity against *Staphylococcus aureus*, *Colloid. Surface. Physicochem. Eng. Aspect.* 487 (2015) 113–120.
- [177] R. Surudžić, A. Janković, N. Babić, et al., Physico-chemical and mechanical properties and antibacterial activity of silver/poly(vinyl alcohol)/graphene nanocomposites obtained by electrochemical method, *Compos. B Eng.* 85

- (2016) 102 112.
- [178] S. Singh, R.K. Gundampati, K. Mitra, et al., Enhanced catalytic and antibacterial activities of silver nanoparticles immobilized on poly(N-vinyl pyrrolidone)-grafted graphene oxide, *RSC Adv.* 5 (2015) 81994 82004.
- [179] P.N. Manikandan, H. Imran, V. Dharuman, Direct glucose sensing and biocompatible properties of a zinc oxide multiwalled carbon nanotube poly(vinyl chloride) ternary composite, *Anal. Methods* 8 (2016) 2691 2697.
- [180] Y. Liu, J. Wen, Y. Gao, et al., Antibacterial graphene oxide coatings on polymer substrate, *Appl. Surf. Sci.* 436 (2018) 624 630.
- [181] F. Ahmed, C.M. Santos, J. Mangadlaio, et al., Antimicrobial PVK:SWNT nanocomposite coated membrane for water purification: performance and toxicity testing, *Water Res.* 47 (2013) 3966 3975.
- [182] Y. Wang, P. Zhang, C.F. Liu, et al., A facile and green method to fabricate graphene-based multifunctional hydrogels for miniature-scale water purification, *RSC Adv.* 3 (2013) 9240 9246.
- [183] N. Mahmoudi, F. Ostadhossein, A. Simchi, Physicochemical and antibacterial properties of chitosan-polyvinylpyrrolidone films containing self-organized graphene oxide nanolayers, *J. Appl. Polym. Sci.* 133 (2016) 1 8, 43194.
- [184] D.R. Dreyer, A.D. Todd, C.W. Bielawski, Harnessing the chemistry of graphene oxide, *Chem. Soc. Rev.* 43 (2014) 5288 5301.
- [185] D. Tasis, N. Tagmatarchis, A. Bianco, et al., Chemistry of carbon nanotubes, *Chem. Rev.* 106 (2006) 1105 1136.
- [186] M. Azizi-Lalabadi, Carbon nanomaterials against pathogens; the antimicrobial activity of carbon nanotubes, graphene/graphene oxide, fullerenes, and their nanocomposites, *Adv. Colloid Interface Sci.* 284 (2020) 1 15, 102250.
- [187] S. Yang, P. Lei, Y. Shan, et al., Preparation and characterization of antibacterial electrospun chitosan/poly (vinyl alcohol)/graphene oxide composite nanofibrous membrane, *Appl. Surf. Sci.* 435 (2018) 832 840.
- [188] Y. Liu, M. Park, H.K. Shin, et al., Facile preparation and characterization of poly(vinyl alcohol)/chitosan/graphene oxide biocomposite nanofibers, *J. Ind. Eng. Chem.* 20 (2014) 4415 4420.
- [189] A. Kassem, G.M. Ayoub, L. Malaeb, Antibacterial activity of chitosan nanocomposites and carbon nanotubes: a review, *Sci. Total Environ.* 668 (2019) 566 576.
- [190] L. He, L.F. Dumée, C. Feng, et al., Promoted water transport across graphene oxide poly(amide) thin film composite membranes and their antibacterial activity, *Desalination* 365 (2015) 126 135.
- [191] C. Cha, S.R. Shin, N. Annabi, et al., Carbon-based nanomaterials: multifunctional materials for biomedical engineering, *ACS Nano* 7 (2013) 2891 2897.
- [192] S. Agarwal, J.H. Wendorff, A. Greiner, Use of electrospinning technique for biomedical applications, *Polymer* 49 (2008) 5603 5621.
- [193] B. Lu, T. Li, H. Zhao, et al., Graphene-based composite materials beneficial to wound healing, *Nanoscale* 4 (2012) 2978 2982.
- [194] J.D. Schiffman, M. Elimelech, Antibacterial activity of electrospun polymer mats with incorporated narrow diameter single-walled carbon nanotubes, *ACS Appl. Mater. Interfaces* 3 (2011) 462 468.
- [195] E.-S. Lee, Y.-O. Kim, Y.-M. Ha, et al., Antimicrobial properties of lignin-decorated thin multi-walled carbon nanotubes in poly(vinyl alcohol) nanocomposites, *Eur. Polym. J.* 105 (2018) 79 84.
- [196] H.N. Chia, B.M. Wu, Recent advances in 3D printing of biomaterials, *J. Biol. Eng.* 9 (4) (2015) 1 14.
- [197] S. Sayyar, Fabrication of 3D structures from graphene-based biocomposites, *J. Mater. Chem. B* 5 (2017) 3462 3482.
- [198] M.E. Hoque, Y.L. Chuan, I. Pashby, Extrusion based rapid prototyping technique: an advanced platform for tissue engineering scaffold fabrication, *Biopolymers* 97 (2012) 83 93.
- [199] Q. Chen, J.D. Mangadlaio, J. Wallat, et al., 3D printing biocompatible polyurethane/poly(lactic acid)/graphene oxide nanocomposites: anisotropic properties, *ACS Appl. Mater. Interfaces* 9 (2017) 4015 4023.
- [200] S. Sayyar, R. Cornock, E. Murray, et al., Extrusion printed graphene/poly-caprolactone/composites for tissue engineering, *Mater. Sci. Forum* 773 (2013) 496 502.
- [201] S. Sayyar, E. Murray, B.C. Thompson, et al., Processable conducting graphene/chitosan hydrogels for tissue engineering, *J. Mater. Chem. B* 3 (2015) 481 490.
- [202] H. Cui, Y. Yu, X. Li, et al., Direct 3D printing of a tough hydrogel incorporated with carbon nanotubes for bone regeneration, *J. Mater. Chem. B* 7 (2019) 7207 7217.
- [203] S.F. Melo, S.C. Neves, A.T. Pereira, et al., Incorporation of graphene oxide into poly(ϵ -caprolactone) 3D printed fibrous scaffolds improves their antimicrobial properties, *Mater. Sci. Eng. C* 109 (2020) 1 21, 110537.
- [204] X.-N. Yang, D.-D. Xue, J.-Y. Li, et al., Improvement of antimicrobial activity of graphene oxide/bacterial cellulose nanocomposites through the electrostatic modification, *Carbohydr. Polym.* 136 (2016) 1152 1160.
- [205] K. Krishnamoorthy, K. Jeyasubramanian, M. Premanathan, et al., Graphene oxide nanopaint, *Carbon* 72 (2014) 328 337.
- [206] C.K. Chua, Z. Sofer, B. Khezri, et al., Ball-milled sulfur-doped graphene materials contain metallic impurities originating from ball-milling apparatus: their influence on the catalytic properties, *Phys. Chem. Chem. Phys.* 18 (2016) 17875 17880.
- [207] P.C. Henriques, I. Borges, A.M. Pinto, et al., Fabrication and antimicrobial performance of surfaces integrating graphene-based materials, *Carbon* 132 (2018) 709 732.
- [208] S. Aslan, M. Deneufchatel, S. Hashmi, et al., Carbon nanotube-based antimicrobial biomaterials formed via layer-by-layer assembly with polypeptides, *J. Colloid Interface Sci.* 388 (2012) 268 273.
- [209] Z.-B. Zhang, J.-J. Wu, Y. Su, et al., Layer-by-layer assembly of graphene oxide on polypropylene macroporous membranes via click chemistry to improve antibacterial and antifouling performance, *Appl. Surf. Sci.* 332 (2015) 300 307.
- [210] Y.T. Joo, K.H. Jung, M.J. Kim, et al., Preparation of antibacterial PDMAEMA-functionalized multiwalled carbon nanotube via atom transfer radical polymerization, *J. Appl. Polym. Sci.* 127 (2013) 1508 1518.
- [211] X. Lu, X. Feng, J.R. Werber, et al., Enhanced antibacterial activity through the controlled alignment of graphene oxide nanosheets, *Proc. Natl. Acad. Sci. Unit. States Am.* 114 (2017) E9793 E9801.
- [212] M. Papi, V. Palmieri, F. Bugli, et al., Biomimetic antimicrobial cloak by graphene-oxide agar hydrogel, *Sci. Rep.* 6 (2016) 1 7.
- [213] M.-H. Wang, Q. Li, X. Li, et al., Effect of oxygen-containing functional groups in epoxy/reduced graphene oxide composite coatings on corrosion protection and antimicrobial properties, *Appl. Surf. Sci.* 448 (2018) 351 361.
- [214] S.C. Smith, D.F. Rodrigues, Carbon-based nanomaterials for removal of chemical and biological contaminants from water: a review of mechanisms and applications, *Carbon* 91 (2015) 122 143.
- [215] H.E. Karahan, C. Wiraja, C. Xu, et al., Graphene materials in antimicrobial nanomedicine: current status and future perspectives, *Adv. Healthcare Mater.* 7 (2018) 1 18, 1701406.
- [216] R. Balzarotti, C. Cinzia, L.F. Francis, Spin coating deposition on complex geometry substrates_ Influence of operative parameters, *Surf. Coating Technol.* 330 (2017) 1 9.
- [217] S. Khanna, Utsav, P. Marathe, et al., Fabrication of long-ranged close-packed monolayer of silica nanospheres by spin coating, *Colloid. Surface. Physicochem. Eng. Aspect.* 553 (2018) 520 527.
- [218] J. Puetz, M.A. Aegerter, Dip coating technique, *Sol-Gel Technol. Glass Prod. Users* (2004) 37 48.
- [219] S. Zhang, Y. Li, N. Pan, Graphene based supercapacitor fabricated by vacuum filtration deposition, *J. Power Sources* 206 (2012) 476 482.
- [220] K. Verma, J. Oder, R. Wille, Simulating industrial electrophoretic deposition on distributed memory architectures, in: 27th Euromicro International Conference on Parallel, Distributed and Network-Based Processing (PDP), 2019, pp. 414 421.
- [221] A. Jaworek, Micro- and nanoparticle production by electrospinning, *Powder Technol.* 176 (2007) 18 35.
- [222] Q. Zhang, J.-Q. Huang, M.-Q. Zhao, et al., Carbon nanotube mass production: principles and processes, *ChemSusChem* 4 (2011) 864 889.
- [223] A. Mottier, F. Mouchet, Pinelli É, et al., Environmental impact of engineered carbon nanoparticles: from releases to effects on the aquatic biota, *Curr. Opin. Biotechnol.* 46 (2017) 1 6.
- [224] Y. Jiao, F. Qian, Y. Li, et al., Deciphering the electron transport pathway for graphene oxide reduction by shewanella oneidensis MR-1, *J. Bacteriol.* 193 (2011) 3662 3665.
- [225] Y.-C. Yong, Y.-Y. Yu, X. Zhang, et al., Highly active bidirectional electron transfer by a self-assembled electroactive reduced-graphene-oxide-hybridized biofilm, *Angew. Chem. Int. Ed.* 53 (2014) 4480 4483.
- [226] G. Wang, F. Qian, C.W. Saltikov, et al., Microbial reduction of graphene oxide by Shewanella, *Nano Res.* 4 (2011) 563 570.
- [227] E.C. Salas, Z. Sun, A. Lüttge, et al., Reduction of graphene oxide via bacterial respiration, *ACS Nano* 4 (2010) 4852 4856.