



HAL
open science

An optogenetic proximity labeling approach to probe the composition of inducible biomolecular condensates in cultured cells

Emile Alghoul, Jihane Basbous, Angelos Constantinou

► To cite this version:

Emile Alghoul, Jihane Basbous, Angelos Constantinou. An optogenetic proximity labeling approach to probe the composition of inducible biomolecular condensates in cultured cells. STAR Protocols, 2021, 2 (3), pp.100677. 10.1016/j.xpro.2021.100677 . hal-03367736

HAL Id: hal-03367736

<https://hal.science/hal-03367736>

Submitted on 31 May 2022

HAL is a multi-disciplinary open access archive for the deposit and dissemination of scientific research documents, whether they are published or not. The documents may come from teaching and research institutions in France or abroad, or from public or private research centers.

L'archive ouverte pluridisciplinaire **HAL**, est destinée au dépôt et à la diffusion de documents scientifiques de niveau recherche, publiés ou non, émanant des établissements d'enseignement et de recherche français ou étrangers, des laboratoires publics ou privés.



Distributed under a Creative Commons Attribution - NonCommercial - NoDerivatives 4.0 International License

Protocol

An optogenetic proximity labeling approach to probe the composition of inducible biomolecular condensates in cultured cells

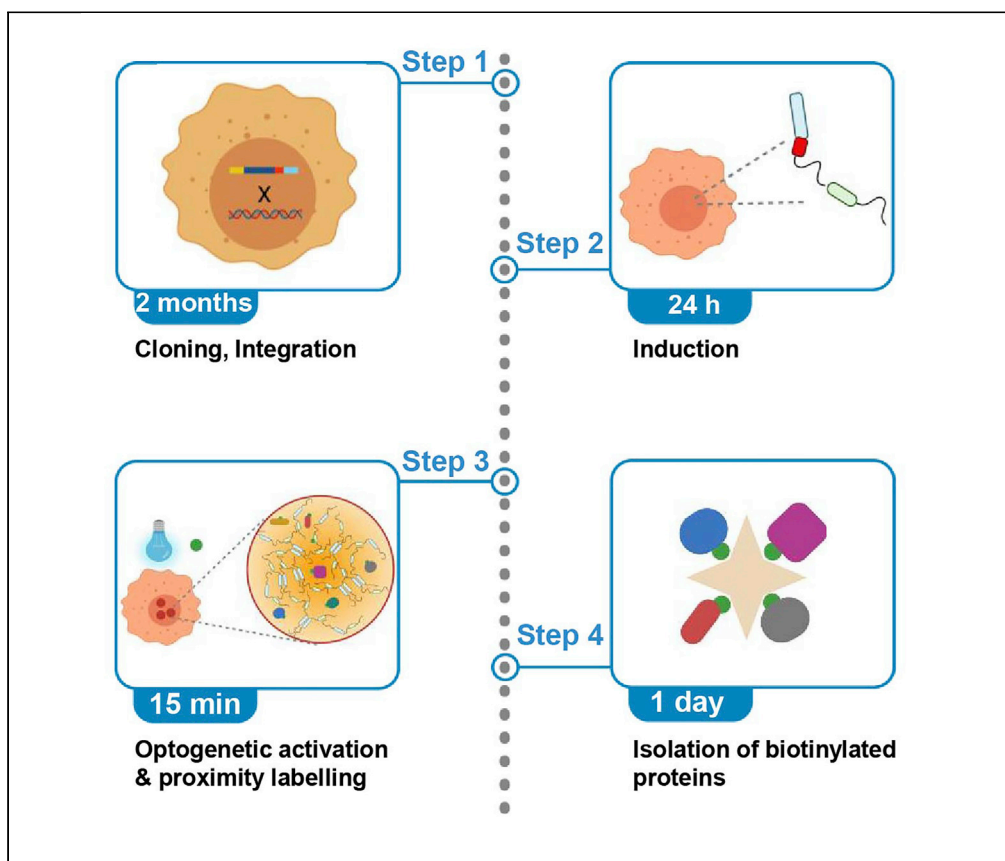

Inducible biomolecular condensates play fundamental roles in cellular responses to intracellular and environmental cues. Knowledge about their composition is crucial to understand the functions that arise specifically from the assembly of condensates. This protocol combines an optogenetic and an efficient proximity labeling approach to analyze protein modifications driven by protein condensation in cultured cells. Low endogenous biotin level ensures sharp signals.

Emile Alghoul,
Jihane Basbous,
Angelos
Constantinou

jihane.basbous@igh.cnrs.fr (J.B.)
angelos.constantinou@igh.cnrs.fr (A.C.)

Highlights

An optogenetic proximity labeling system to probe the function of condensates

The method can be used to analyze protein partitioning within condensates

The method reveals post-translational modifications induced by condensation

Alghoul et al., STAR Protocols
2, 100677
September 17, 2021 © 2021
The Authors.
<https://doi.org/10.1016/j.xpro.2021.100677>



Protocol

An optogenetic proximity labeling approach to probe the composition of inducible biomolecular condensates in cultured cells

Emile Alghoul,¹ Jihane Basbous,^{1,2,*} and Angelos Constantinou^{1,3,*}¹Institut de Génétique Humaine, CNRS, Université de Montpellier, Montpellier, France²Technical contact³Lead contact*Correspondence: jihane.basbous@igh.cnrs.fr (J.B.), angelos.constantinou@igh.cnrs.fr (A.C.)
<https://doi.org/10.1016/j.xpro.2021.100677>

SUMMARY

Inducible biomolecular condensates play fundamental roles in cellular responses to intracellular and environmental cues. Knowledge about their composition is crucial to understand the functions that arise specifically from the assembly of condensates. This protocol combines an optogenetic and an efficient proximity labeling approach to analyze protein modifications driven by protein condensation in cultured cells. Low endogenous biotin level ensures sharp signals. For complete details on the use and execution of this protocol, please refer to Frattini et al. (2021).

BEFORE YOU BEGIN

Sub-cellular compartments are essential for the organization of cell physiological processes. Compartments that are not surrounded by a membrane, called biomolecular condensates, can form via the self-assembly of multivalent protein scaffolds and nucleic acids (Banani et al., 2017; Hyman and Simons, 2012; Lyon et al., 2020; Shin and Brangwynne, 2017). An analysis of the composition of biomolecular condensates is necessary to understand their associated functions. Condensates, however, are labile and intrinsically difficult to isolate. If a major protein component of the condensate is known, then proximity labeling approaches can be used to identify the other components of the condensate (Branon et al., 2018; Lam et al., 2015; Roux et al., 2012; Youn et al., 2018). Many biomolecular condensates, however, form only transiently in response to environmental changes. Furthermore, methods are required to understand the functions that arise specifically from the assembly of biomolecular condensates. To tackle this problem, we present here a method that combines proximity labeling with optogenetics to control the formation of a biomolecular condensate in live cells (Bracha et al., 2019; Bracha et al., 2018). A protein scaffold with intrinsic capacity to undergo liquid phase separation is fused to a photoreceptor that oligomerizes upon exposure to a specific light wavelength. Light-induced oligomerisation of the photoreceptor facilitates the phase separation of the protein scaffold that forms a condensate, within minutes. In comparisons with analogous chemogenetics approaches, optogenetics offers a better timing resolution. In association with proximity labeling, the actuation of condensates enables to probe the functional consequences of protein condensation and to reveal the composition of the resulting compartment. In the method described below, a protein scaffold is fused to both cryptochrome 2 (Palayam et al., 2021), a light responsive photoreceptor from *Arabidopsis thaliana* and to TurboID (Branon et al., 2018), a highly efficient biotin ligase. We used this method to show that the activity of the master checkpoint kinase ATR is amplified within nuclear condensates formed by the multivalent protein scaffold TopBP1 (Frattini et al., 2021). The method is applicable to multi-modular protein scaffolds that have intrinsic capacity to self-assemble and phase separate to yield biomolecular condensates.



Note: Optogenetic-induction of biomolecular condensates on a cell-population scale requires an illumination device adapted to cell culture formats. Resources for the construction of optogenetics light boxes are available at <https://www.optobase.org/materials/>.

KEY RESOURCES TABLE

REAGENT or RESOURCE	SOURCE	IDENTIFIER
Antibodies		
pATR (T1989)	GeneTex	Cat# GTX128145; RRID: AB_2687562
Chk1	Santa Cruz Biotechnology	Cat# sc-8408; RRID: AB_627257
pChk1 (Ser345)	Cell Signaling Technology	Cat# 2348; RRID: AB_331212
TopBP1	Bethyl	Cat# A300-111A; RRID: AB_2272050
pTopBP1 (Ser1138)	Interchim	Cat# orb140434
Alexa Fluor 546 goat anti-mouse IgG	Molecular Probes	Cat# A-11030; RRID: AB_144695
Alexa Fluor 546 goat anti-rabbit IgG	Molecular Probes	Cat# A-11010; RRID: AB_2534077
Alexa Fluor 488 goat anti-mouse IgG2b	Molecular Probes	Cat# A-21141; RRID: AB_141626
Alexa Fluor 488 goat anti-rabbit IgG	Molecular Probes	Cat# A-21141; RRID: AB_141626
Anti-mouse IgG, HRP linked Antibody	Cell Signaling Technology	Cat# 7076; RRID: AB_330924
Anti-rabbit IgG, HRP linked Antibody	Cell Signaling Technology	Cat# 7074; RRID: AB_2099233
ATR	Bethyl/Euromedex	Cat# A300-137A; RRID: AB_185544
FancJ/BRIP1	Novus	Cat# NB100-416; RRID: AB_2066307
BRCA1(C-20)	Santa Cruz Biotechnology	Cat# sc-642; RRID: AB_630944
Bacterial and virus strains		
5-alpha Competent <i>E. coli</i> (High Efficiency)	NEB	Cat# C2987
Chemicals, peptides, and recombinant proteins		
Biotin	Sigma-Aldrich	Cat# B4501; CAS: 58-85-5
Doxycycline	Clontech	Cat# 631311; CAS: 10592-13-9
Blasticidin	InvivoGen	Cat# ant-bl
Hygromycin	Sigma-Aldrich	Cat# H3274; CAS: 31282-04-9
Zeocin	ThermoFisher Scientific	Cat# R25001
Penicillin Streptomycin	Sigma-Aldrich	Cat# P0781; ID 329820056
Ampicilin	Sigma-Aldrich	Cat# A9518; CAS: 69-52-3
cOplete, EDTA free	Roche	Cat# 4693159001
Halt phosphatase inhibitor cocktail	ThermoFisher Scientific	Cat# 78427
Benzonase Nuclease	Sigma-Aldrich	Cat# E1014; CAS: 9025-65-4
Ethidium bromide solution	Sigma-Aldrich	Cat# E1510; CAS: 1239-45-8
Streptavidin-Agarose	Sigma-Aldrich	Cat# S1638; MDL: MCFD00082035
Dulbecco's Modified Eagle's Medium - high glucose	Sigma-Aldrich	Cat# D5796
BioWest - Fetal Bovine Serum	Eurobio Scientific	Cat# S1810
Glycerol ≥ 99.5%	VWR Chemicals	Cat# 24388.295; CAS: 56-81-5
Bromophenol Blue	Ethylenediaminetetraacetic acid	Cat# B0126; CAS: 115-39-9
Ethylenediaminetetraacetic acid	Ethylenediaminetetraacetic acid	Cat# EDS; CAS: 60-00-4
HEPES	Sigma-Aldrich	Cat# H3375; CAS: 7365-45-9
Sodium Chloride	VWR Chemicals	Cat# 27810-295; CAS: 7647-14-5
Ethylene glycol-bis(2-aminoethylether)-N,N,N',N'-tetraacetic acid	Sigma-Aldrich	Cat# E4378; CAS: 67-42-5
Sodium deoxycholate ≥ 97%	Sigma-Aldrich	Cat# D6750; CAS: 302-95-4
Triton X-100	Sigma-Aldrich	Cat# T8787; CAS: 9002-93-1
Tergitol Solution type NP-40	Sigma-Aldrich	Cat# NP40S; MDL: MFCD01779855
Sodium dodecyl sulfate 20%	Biosolve	Cat# 198123; CAS:151-21-3
Tris base	Euromedex	Cat# 200923-A; CAS: 77-86-1
Dulbecco's Phosphate Buffered Saline	Sigma-Aldrich	Cat# D8537; MDL: MFCD00131855
Water	Sigma-Aldrich	Cat# W3500; CAS: 7732-18-5
LiCl	Sigma-Aldrich	Cat# L9650; CAS: 7447-41-8
Critical commercial assays		
Clarity Western ECL Substrate	Bio-Rad	Cat# 170-5061
Clarity Max Western ECL Substrate	Bio-Rad	Cat# 1705062

(Continued on next page)

Continued

REAGENT or RESOURCE	SOURCE	IDENTIFIER
Criterion TGX stain free gel 7,5%	Bio-Rad	Cat# 5678024
Criterion TGX Stain-Free Gel 4–15%	Bio-Rad	Cat# 5678084
Criterion TGX Stain-Free Gel 10%	Bio-Rad	Cat# 5671034
Mini-PROTEAN TGX Stain-Free Gels, 7.5%	Bio-Rad	Cat# 4568023
Mini-PROTEAN TGX Stain-Free Gels, 4–15%	Bio-Rad	Cat# 4568083
Mini-PROTEAN TGX Stain-Free Gels, 10%	Bio-Rad	Cat# 4568033
Trans-Blot Turbo Transfer Pack 0,2µm Nitrocellulose Midi, 10 pack	Bio-Rad	Cat# 1704159
Trans-Blot Turbo Transfer Pack 0,2µm Nitrocellulose Mini, 10 pack	Bio-Rad	Cat# 1704158
Color Prestained Protein Standard, Broad Range	BioLabs	Cat# P7712S
Lipofectamine 2000	ThermoFisher Scientific	Cat# 11668-019
Quick Start™ Bradford 1 × Dye Reagent	Bio-Rad	Cat# 500-0205
Filter Syringe Clearline 30mm AC 0,2 µm	Dominique Dutscher	Cat# DSR146560
TERUMO Syringe Without Needle 5ML	Dominique Dutscher	Cat# 050006D
TERUMO Syringe Without Needle 10ML	Dominique Dutscher	Cat# 050008
Cell Spatula	TPP - Techno Plastic Products	Cat# 99010
Amersham Hyperfilm ECL (8 × 10")	Dominique Dutscher	Cat# 28906839
Deposited data		
Raw data	This paper	https://doi.org/10.17632/zb35ntwpjx.1
Experimental models: Cell lines		
Flp-In™ T-REx™ 293	Invitrogen	Cat# R78007; RRID: CVCL_U427
Oligonucleotides		
TurboID Nter: catccagctgtttgac	Eurofins MWG	N/A
TurboID Cter: aggcctggctccatatt	Eurofins MWG	N/A
CRY2 Cter: ggcgcgccctcagtcagcatgttcaggt	Eurofins MWG	N/A
CRY2 Nter and mCherry Cter: ggtcagatccaagagccttc	Eurofins MWG	N/A
mCherry Nter: agggtcgccctcgctt	Eurofins MWG	N/A
Recombinant DNA		
pCDNA5_FRT-TO_TurboID-mCherry-Cry2	Frattini et al, 2021	Addgene; Cat# 166504
pCDNA5_FRT-TO_TurboID-TopBP1WT-mCherry-Cry2	Frattini et al, 2021	N/A
pOG44 Flp-Recombinase Expression Vector	Thermo Fisher Scientific	Cat# V600520
Software and algorithms		
OMERO	OME Remote Objects software	https://www.openmicroscopy.org/
Cell Profiler 2.2.0	Cell image analysis software	https://cellprofiler.org/
Image Lab™ Software (Version 5.2.1)	Bio-Rad	http://www.bio-rad.com/fr-fr/product/image-lab-software?ID=KRE6P5E8Z
Biorender Software	Science Suite Inc.	RRID: SCR_018361
Other		
CO2 Incubator C150	Binder	Cat# 9040-0078
Sonicator, VibraCell- 72405	BioBlock scientific	N/A
KNF LABOPORT Mini Diaphragm Vacuum Pump N 811 in Pumps, Compressors	Dominique Dutscher	Cat# KNF_28002
Centrifuge Hettich Mikro 200	Grosseron	N/A
Mini-PROTEAN Tetra Vertical Electrophoresis Cell	Bio-Rad	Cat# 1658004
PowerPac™ HC High-Current Power Supply	Bio-Rad	Cat# 1645052
Trans-Blot Turbo Transfer System	Bio-Rad	Cat# 1704150

MATERIALS AND EQUIPMENT

Equipment

We use a custom-made illumination box containing an array of 24 Light Emitting Diode (LEDs) (488 nm) delivering 10 mW/cm² (light intensity measured using a ThorLabs-PM16-121-power meter). The 24 LEDs are made of Cree® XLamp® XR-E LED (Figure 2). The details on how to build the light box along with the code used for programming is described here: <https://github.com/jvrana/OptogeneticsLightBox>. Alternatively, a service for tailored made optogenetic devices is

available at <https://optobiolabs.com/>. Additional information on optogenetic illumination devices is available at <https://www.optobase.org/materials/>

Preparation of buffers

RIPA/SDS Lysis buffer			
Reagent	Stock concentration	Final concentration	Amount
Tris-HCl pH 7.5	1 M	50 mM	2.5 mL
NaCl	5 M	150 mM	1.5 mL
EDTA	0.5 mM	1 mM	100 μ L
EGTA	0.5 mM	1 mM	100 μ L
NP-40	100%	1%	500 μ L
SDS	20%	0.1%	250 μ L
Sodium deoxycholate	n/a	0.5%	250 mg
ddH ₂ O	n/a	n/a	Up to 50 mL
Total	n/a	n/a	50 mL

n/a– not applicable

⚠ **CRITICAL:** For SDS usage, wear personal protective equipment/face protection.

Store the buffer at 4°C for three to six weeks.

Wash Buffer 1			
Reagent	Stock concentration	Final concentration	Amount
SDS	20%	2%	5 mL
ddH ₂ O	n/a	n/a	45 mL
Total	n/a	n/a	50 mL

n/a– not applicable

⚠ **CRITICAL:** For SDS usage, wear personal protective equipment/face protection.

Store the buffer at 18°C–25°C.

Wash Buffer 2			
Reagent	Stock concentration	Final concentration	Amount
HEPES pH 7.5	0.5 M	50 mM	5 mL
NaCl	5 M	500 mM	5 mL
EDTA	0.5 mM	1 mM	100 μ L
Triton X-100	20%	1%	2.5 mL
Sodium deoxycholate	n/a	0.2%	100 mg
ddH ₂ O	n/a	n/a	Up to 50 mL
Total	n/a	n/a	50 mL

n/a– not applicable

⚠ **CRITICAL:** Store the buffer at 4°C for three to six weeks.

Wash Buffer 3			
Reagent	Stock concentration	Final concentration	Amount
Tris-HCl pH 7.5	1 M	10 mM	500 μ L
LiCl	1 M	250 mM	12.5 mL
NaCl	5 M	500 mM	5 mL

(Continued on next page)

Continued

Reagent	Stock concentration	Final concentration	Amount
EDTA	0.5 mM	1 mM	100 μ L
Triton X-100	20%	1%	2.5 mL
NP-40	n/a	0.5%	250 μ L
Sodium deoxycholate	n/a	0.5%	250 mg
ddH ₂ O	n/a	n/a	Up to 50 mL
Total	n/a	n/a	50 mL

n/a– not applicable

Wash Buffer 4

Reagent	Stock concentration	Final concentration	Amount
Tris-HCl pH 7.5	1 M	50 mM	2.5 mL
NaCl	5 M	50 mM	500 μ L
ddH ₂ O	n/a	n/a	47 mL
Total	n/a	n/a	50 mL

n/a– not applicable

2X Laemmli Sample buffer

Reagent	Stock concentration	Final concentration	Amount
Tris-HCl pH 6.8	1 M	65.8 mM	3.29 mL
Glycerol	n/a	26.3%	13.15 mL
SDS	20%	2.1%	5.25 mL
Bromophenol blue	n/a	0.01%	5 g
ddH ₂ O	n/a	n/a	Up to 50 mL
Total	n/a	n/a	50 mL

n/a– not applicable

The day of the experiment, add 50 μ L of 2-mercaptoethanol (14.3 M) per 950 μ L of 2X Laemmli Sample buffer (Total volume 1 mL).

To obtain 1 X Laemmli Sample buffer, dilute 1 mL of 2 \times Laemmli Sample buffer with 1 mL distilled water.

△ CRITICAL: For SDS usage, wear personal protective equipment/face protection.

Store the buffer at 18°C–25°C for up to 2 years without adding 2-mercaptoethanol.

Stock solutions

Biotin Stock Solution

Reagent	Final concentration	Amount
Biotin	250 mM	610 mg
DMSO	n/a	Up to 10 mL
Total	n/a	10 mL

Note: Filter with 0.22 μ m filter, prepare 100 μ L aliquots of the stock solution and store at –20°C for up to 1 year. Avoid repeated freeze-thaw cycles.

Biotin Working Solution			
Reagent	Stock concentration	Final concentration	Amount
Biotin	250 mM	500 μ M	20 μ L
DMEM media	n/a	n/a	Up to 20 mL
Total	n/a	n/a	10 mL

n/a– not applicable

Doxycycline Stock Solution			
Reagent	Final concentration	Amount	
Doxycycline	10 mg/mL	100 mg	
ddH ₂ O	n/a	Up to 10 mL	
Total	n/a	10 mL	

Use the 10 mg/mL stock solution of doxycycline to further dilute 1:5000 to obtain 2 μ g/mL working solution in the DMEM medium supplemented with 10% FBS.

Note: Filter with 0.22 μ m filter, prepare 100 μ L aliquots of the stock solution and store at -20° C for up to 1 year. Avoid repeated freeze-thaw cycles.

STEP-BY-STEP METHOD DETAILS

The first major step is to create a stable cell line for the inducible expression of a protein scaffold that forms a biomolecular condensate, tagged with TurboID and Cry2.

Cloning procedure

⌚ Timing: 2 weeks

1. Introduce your gene of interest (GOI), which encodes a major phase separation component of a condensate, into the pCDNA5_FRT-TO_TurboID-mCherry-Cry2 (Opto-module). We have deposited this plasmid with Addgene (ID number 166504).
Sub-clone the cDNA encoding your protein of interest into pCDNA5_FRT-TO_TurboID-mCherry-Cry2 using standard molecular biology procedures. You can use a variety of cloning strategies. For example, the cDNA can be sub-cloned in the KpnI site of the vector (Figure 1) using the In-Fusion HD cloning system (Takara Bio, USA). For a detailed protocol and instructions on the design of primers, follow the manufacturer's guidelines (https://www.takarabio.com/documents/User%20Manual/In/In-Fusion%20HD%20Cloning%20Kit%20User%20Manual_102518.pdf).
2. Verify by DNA sequencing that the cDNA has been inserted in frame and that no mutations have been introduced in the construct.
 - a. Design multiple primers set to cover the entire gene of interest.
 - b. Use the primers indicated in the Key Resources for the sequencing of the TurboID, mCherry and CRY2 genes.

This construct will allow you to generate stable Flp-InTM-RExTM293 cell lines to express your protein of interest fused to TurboID and mcherry-CRY2, in an inducible manner. Before the production of stable cell lines, we recommend that you transfect the construct transiently to verify the expression and the localization of your protein of interest, as described below.

Experimental validation of your construct

3. Thaw the Flp-InTM-RExTM293 cell line several days before the transfection day and maintain the cell line in medium containing Zeocin selective reagent (100 μ g/mL) and blasticidin (15 μ g/mL).

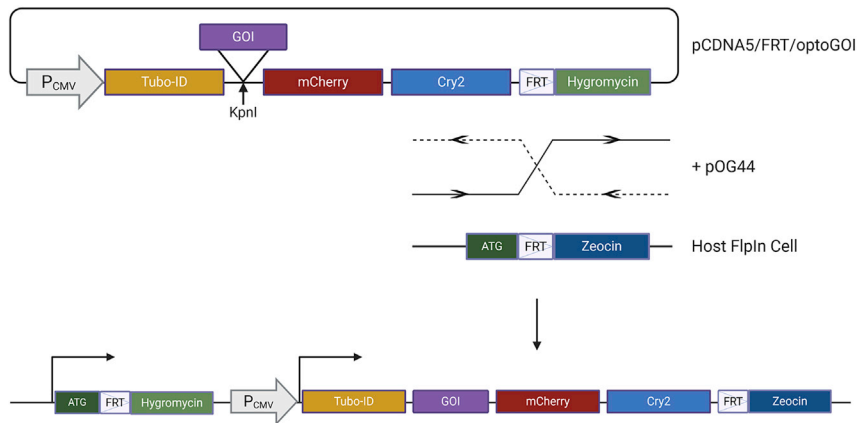

Figure 1. Schematic representation of the pCDNA5_FRT-TO_TurboID-GOI-mCherry-Cry2 backbone vector and the cloning site of the gene of interest (GOI)

The GOI is under the control of a tetracycline-regulated CMV/TetO₂ promoter and stably integrated into the Flp-InTM-RExTM293 cell line after co-transfection with the pOG44 recombinaise. Stable transfectants are resistant to hygromycin B and blasticidin.

Refer to the manufacturer's instructions for culturing and handling the Flp-InTM-RExTM293 cell line: (https://assets.thermofisher.com/TFS-Assets/LSG/manuals/flpintrexcells_man.pdf).

4. Transfect Flp-InTM-RExTM293 using LipofectamineTM 2000 Reagent as described in the manufacturer's instructions (https://assets.thermofisher.com/TFS-Assets/LSG/manuals/Lipofectamine_2000_Reag_protocol.pdf)
5. Verify by Western blotting that your protein of interest is expressed using either an anti-mCherry antibody or an antibody directed against your protein of interest.
6. Using standard fluorescence microscopy, verify the intracellular localization of your protein of interest.

Generation of stable cell lines expressing your protein of interest

⌚ Timing: 6–8 weeks

7. Generate stable Flp-InTM-RExTM293 expression cell lines by co-transfection of the pCDNA5_FRT-TO_TurboID-GOI-mCherry-Cry2 expression construct and the pOG44 recombinaise plasmid (Figure 1).

Note: We used Flp-InTM-RExTM293 cell lines but it is also possible to use Flp-InTM-RExTM U2OS/HeLa cell lines. We noticed however that the expression level of recombinant proteins was heterogeneous in U2OS/HeLa Flp-InTM-RExTM cells.

Note: Flp-InTM-RExTM293 are generally amenable to transfection using standard methods. However, we recommend the transfection by LipofectamineTM 2000 Reagent. Refer to the manufacturer's instructions for the transfection procedure (https://assets.thermofisher.com/TFS-Assets/LSG/manuals/Lipofectamine_2000_Reag_protocol.pdf).

8. Select stable transfectants using 100–200 μg/mL hygromycin B.
9. After 6–8 weeks of selection, pool all the hygromycin resistant foci.
10. Grow the cells until 70–80% confluence, harvest and freeze multiple vials of early-passage cells.

⏸ **Pause point:** Place the cell vials in liquid nitrogen for long-term cryopreservation.

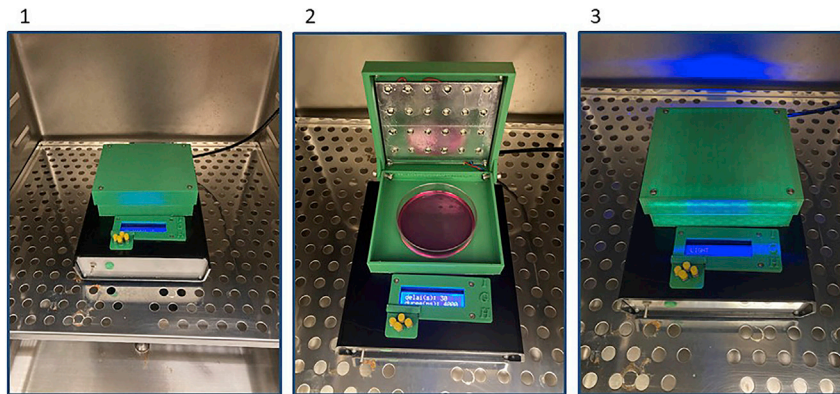

Figure 2. A custom-built blue LED illumination device used for this method

The illumination box is placed inside a cell culture incubator at 37°C with 5% CO₂.

Experimental validation of the stable cell lines

⌚ Timing: 1 week

11. Induce the expression of your gene of interest with doxycycline to a final concentration of 2 μg/mL.

Note: Optimize the concentration of doxycycline for your specific application.

Note: For immunofluorescence analysis, culture cells on coverslips.

12. Incubate the cells for 16 h to 24 h at 37°C.

13. The next day, place the plates in the illumination box in a CO₂ incubator for optogenetic activation (Figure 2.2).

Apply multiple light-dark cycles. For induction of TopBP1 condensation, we use cycles of 4 s light followed by 10 s dark for 3 min (Figure 2.3).

Note: Induction of biomolecular condensates usually occurs within minutes. The efficacy of optogenetic induction of condensates depends on protein concentration and protein sequence, hence the time of exposure to blue-light depends on your specific application.

14. Process the samples for whole cell extraction or fixation and immunostaining using standard procedures.

- a. Evaluate the expression level of the doxycycline-inducible protein by immunoblot analysis (Figure 3A).
- b. Verify by standard fluorescence microscopy the ability of your recombinant protein to form biomolecular condensates upon light activation (Figure 3B).

Biotin - labeling of proteins within light-induced condensates

⌚ Timing: 2 days

In this second major step, you will control the formation of biomolecular condensates with 488 nm light and label component proteins with biotin (Figure 4).

The required number of cells depends on your specific application (e.g., immunoblotting, mass spectrometry). This protocol describes the analysis of TopBP1 proximal proteins by immunoblotting

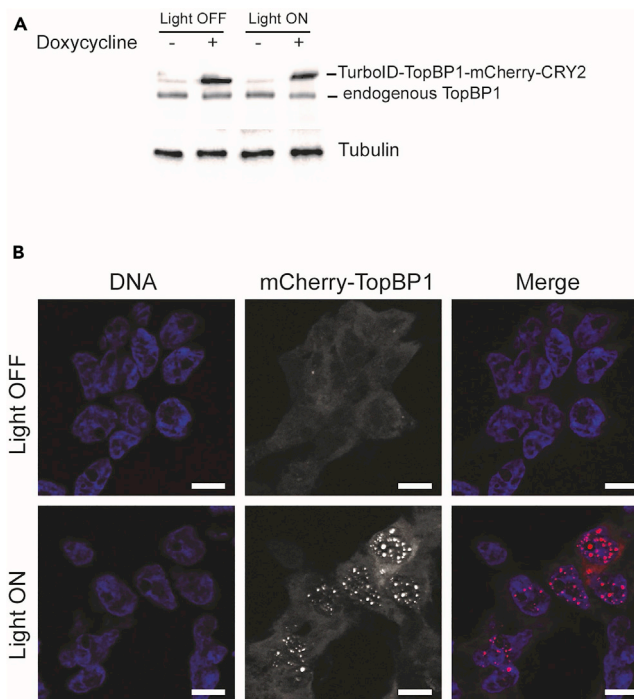

Figure 3. Validation of the TurboID-TopBP1-mCherry-Cry2 protein expression and condensation system

(A) Whole-cell extracts from Flp-InTMT-RExTM293 cell line expressing stably TurboID-TopBP1-mCherry-Cry2 were incubated or not with 2 μ g/mL doxycycline for 24 h, as indicated, and the indicated proteins were revealed by immunoblotting. Tubulin is a loading control.

(B) Representative fluorescence images of cells expressing TurboID-TopBP1-mCherry-Cry2, before (Light OFF) and after (Light ON) optogenetic activation with cycles of 4 s light (488nm)-10 s resting for 3 min. DNA is stained with Hoechst 33258. Scale bars: 10 μ m.

using 4×10^6 Flp-InTMT-RExTM293 cells stably transfected with the doxycycline-inducible TurboID-TopBP1WT-mCherry-Cry2 construct.

Day 1 Morning:

15. Prewarm cell media, PBS, and trypsin at 37°C in a water bath.
16. Seed 4×10^6 Flp-InTMT-RExTM293 cells/per 10 cm dish in 5 mL of DMEM medium supplemented with 10% fetal bovine serum (FBS) without any selection antibiotics. Use three dishes for a typical experiment:
 - a. with doxycycline/ Light OFF
 - b. without doxycycline/ Light ON
 - c. with doxycycline/ Light ON

Day 1 Evening:

17. Add 4 μ g/mL of doxycycline in a falcon tube containing 5 mL of DMEM supplemented with 10% FBS to reach a final concentration of 2 μ g/mL doxycycline, as described in step 18.
18. Add the 5 mL DMEM supplemented with 10% FBS and 4 μ g/mL doxycycline to the 5 mL cells culture from step 16. The final concentration of doxycycline is 2 μ g/mL. Allow protein expression for 16–24 h.

Day 2:

19. Prewarm the DMEM supplemented with 10% FBS at 37°C.

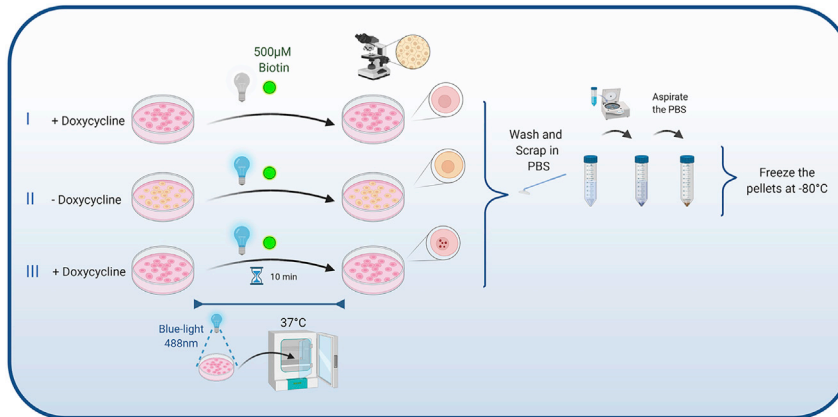

Figure 4. Step-by-step representation of the experimental plan

Induction of condensates via optogenetic activation and biotin labeling of component proteins. Created with [BioRender.com](https://www.biorender.com).

20. Thaw the biotin stock solution.
21. Prepare in 15 mL Falcon tube 10 mL of DMEM supplemented with 500 μ M biotin and keep at 37°C.
22. Place the illumination box in a humidified 37°C incubator with 5% CO₂ (Figure 2).
23. Replace the cell culture medium with 10 mL of DMEM media supplemented with 500 μ M biotin and 2 μ g/mL doxycycline.

△ CRITICAL: Add the medium from the wall of the cell culture dish and not directly on the cells to avoid cell detachment.

24. Transfer rapidly the cell culture dish **without cover** into the custom-made illumination box and turn ON the device.

Note: At this stage, it is not essential to manipulate cells in a sterile environment because the cells will be collected and lysed for biochemical analyses immediately after optogenetic induction of condensates.

25. Expose the cells to blue light for 10 min of light-dark cycles (4 s light followed by 30 s dark).

Note: In principle, high doses of 488 nm light could generate reactive oxygen species. However, in comparison with dental photo-polymerization sources, for example, the light intensity used here (10 mW/cm²) is weak. Yet, it would be wise to minimize exposure times. For example, 3 minutes of light dark cycles (4 s light followed by 10 s resting in the dark) induce robust TopBP1 condensation. After optogenetic activation, condensates will dissolve progressively. Five minutes after light activation, approximately 40% of TopBP1 condensates have dissolved (Frattini et al. 2021). The light-dark cycle parameters required for the maintenance of condensates during proximity labeling depends on the cellular concentration and on the sequence of the protein that holds condensates together via multiple weak and cooperative interactions. The parameters of optogenetic activation need to be determined on a case-by-case basis.

26. Turn OFF the device.
27. Remove medium completely by aspiration and wash the cells carefully at 18°C–25°C with 5 mL/ of 1× PBS per dish.

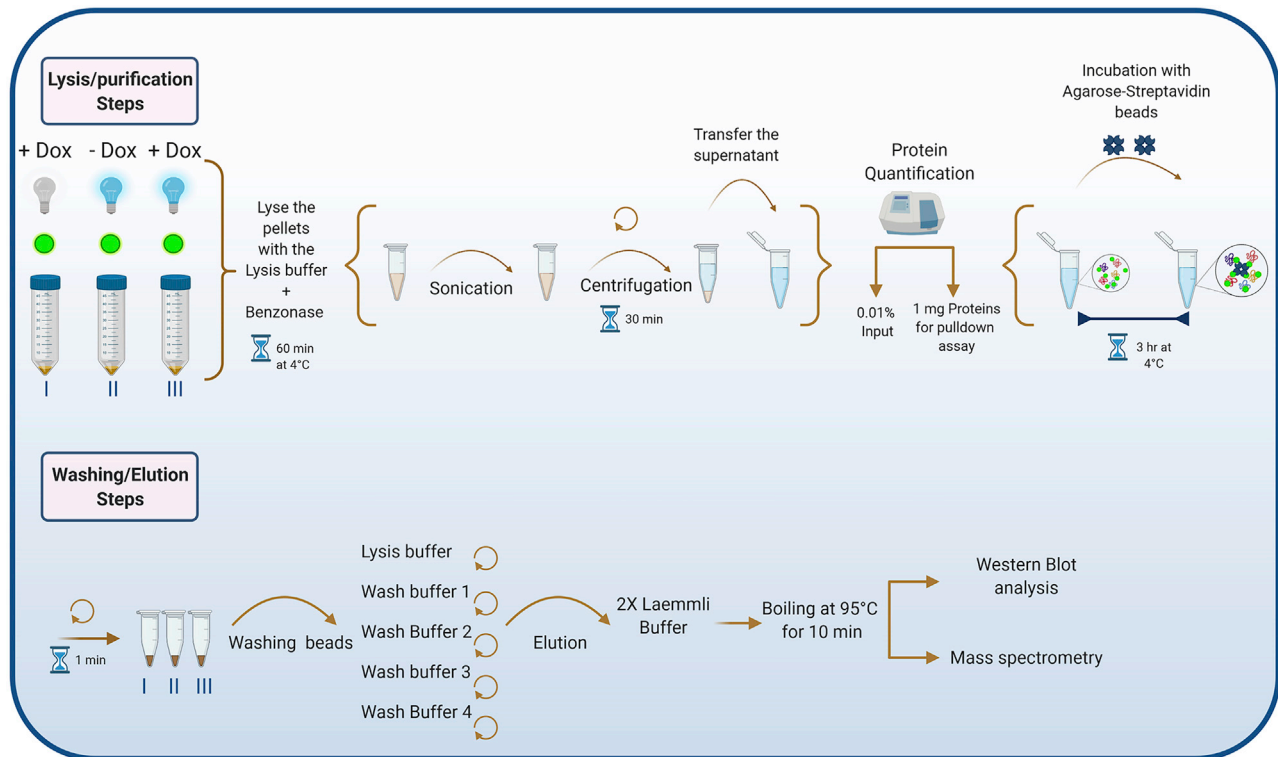

Figure 5. Step-by-step representation of the experimental plan to isolate biotinylated proteins by affinity
Created with BioRender.com.

28. Gently scrape all the cells off the plate with a cell scraper and place the cell suspension in a 15 mL Falcon tube. Keep on ice.
29. Centrifuge the cells at $400 \times g$ for 3 min.
30. Aspirate the medium and freeze the pellet at -80°C .
31. Proceed to the next step.

⏸ Pause point: You can store the cell pellets at -80°C for several weeks before proceeding to the next step.

Affinity purification of biotinylated proteins

⌚ Timing: 2 days

The third major step is to isolate biotinylated proteins using streptavidin coated beads and identify these proteins by immunoblotting or proteomic analyses (Figure 5).

32. Prepare all the buffers listed in the Materials section (You can prepare them several days before the experiment).

Note: To reduce keratin contamination, use DNase/RNase-free tubes that have not previously been opened and wear gloves.

33. The day of the experiment, add 1X of complete protease and phosphatase inhibitors to 10 mL of RIPA/SDS Lysis buffer.
34. Thaw gently the frozen cell pellets.

35. Resuspend the cell pellet in 500 μ L of RIPA/SDS Lysis buffer supplemented with 1X complete protease and phosphatase inhibitors and 250 U benzonase and transfer the lysate into 1.5 mL Eppendorf tube.
36. Incubate the pellet on a rotating wheel for 1 h at 4°C.
37. Sonicate the lysate on ice using a sonicator (40% amplitude, 3 cycles 10 s sonication- 2 s resting).

△ CRITICAL: Clean the sonicator probe between samples to avoid cross-contamination.

38. Spin down cellular debris at 16000 \times g for 30 min at 4°C.

Note: During the centrifugation step, prepare the required amount of agarose-streptavidin (50 μ l of agarose streptavidin beads slurry per condition). Resuspend gently the stock of streptavidin beads by tapping/flicking the bottom of the tube. Wash the beads twice with RIPA/SDS lysis buffer and resuspend in RIPA/SDS buffer.

39. Transfer the cleared supernatant to a new 1.5 mL Eppendorf tube.
40. Determine total protein concentration using Bradford protein assay.
41. To isolate biotinylated proteins from cell lysates, incubate up to 1 mg of cell lysates with the pre-washed agarose-streptavidin beads for 3 h on a rotating wheel at 4°C.
42. Spin the bead suspensions for 1 min at 400 \times g, at 18°C–25°C, and carefully remove the supernatant by pipetting.
43. Wash the beads via resuspension and incubation on a rotating wheel for 3 min as indicated below. Between each step, pull down the beads by centrifugation for 1 min at 400 \times g at 18°C–25°C and remove carefully the supernatant:
 - a. Wash with 1 mL of RIPA/SDS Lysis buffer
 - b. Wash with 1 mL Wash buffer 1
 - c. Wash with 1 mL Wash buffer 2
 - d. Wash with 1 mL Wash buffer 3
 - e. Wash with 1 mL Wash buffer 4 (twice)

△ CRITICAL: Avoid pipetting the beads excessively, as they can bind to the pipet tips, leading to sample loss.

44. Add 60 μ L of 2X Laemmli Sample buffer to each sample and flick to mix.
45. Heat samples for 10 min at 95°C to elute the proteins.

▮▮ Pause point: The samples can be stored at –20°C or –80°C for at least 1 year.

△ CRITICAL: Avoid multiple boiling and freezing cycles of your samples.

46. For western blot analysis, resolve proteins by SDS-polyacrylamide gel electrophoresis (SDS-PAGE). We recommend loading 2–4 μ g of proteins in the “Input” control well.
47. For Mass spectrometry analyses, use up to 2 mg of proteins isolated by streptavidin pull down. Analyze raw mass spectrometry data using the MaxQuant software (version 1.5.5.1) with standard settings. Use Perseus (version 1.6.1.1) for graphical representation and statistical analysis. Perform a standard t test to evaluate differences of protein abundance between samples.

EXPECTED OUTCOMES

The protocol allows probing and identifying proteins and their post-translational modifications in proximity of a protein scaffold before and after its self-assembly into a biomolecular condensate. An example is shown in (Frattoni et al., 2021) where phospho-signals that indicate ATR kinase

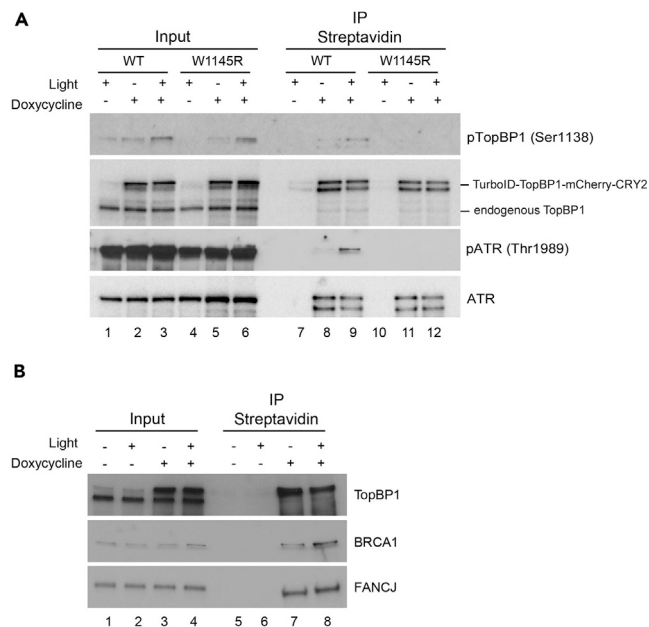

Figure 6. Illustration of expected outcomes

Flp-InTM-RExTM293 cell line expressing TurboID-TopBP1-mCherry-Cry2 were incubated with 500 μ M of biotin and exposed to blue light for 10 min of light-dark cycles (4 s light followed by 30 s dark). TopBP1 partner proteins labeled with biotin were pulled-down using streptavidin-coated beads.

(A) Ser1138 phospho TopBP1, TopBP1, Thr1989 phospho ATR and ATR were detected by immunoblotting. This figure is reprinted with permission from Frattini et al., 2021.

(B) Immunoblot of TopBP1, BRCA1 and FANCD1 isolated with streptavidin-coated beads.

activity are probed. In this experiment, phospho Ser1138 TopBP1 and phospho Thr1989 ATR signals are detected in proximity of TopBP1 specifically after induction of TopBP1 condensation by optogenetic activation (Figure 6A, lane 9). By contrast, phospho Ser1138 TopBP1 and phospho Thr1989 ATR are not detected in cells expressing the condensation defective mutant W1145R TopBP1 (Figure 6A, lane 12). In this particular example, the condensation of TopBP1 acts as a molecular switch for the activation of the ATR signaling pathway. The method can be exploited also to monitor the enrichment of proximal proteins as a result of their partitioning within condensates. For example, Figure 6B shows an immunoblot of FANCD1 and BRCA1, two TopBP1 partner proteins detected by proximity labeling. Upon optogenetic induction of TopBP1 condensates, the BRCA1 signal increases (Figure 6B, lane 8), suggesting that BRCA1 concentrates within TopBP1 condensates.

LIMITATIONS

The fusion of a biotin ligase and a cryptochrome to a protein can potentially affect its stability, expression level and localization. These parameters should be verified beforehand to exclude potential alterations of protein properties and functions. Biotinylation of the TurboID fusion protein may interfere with protein activity and exert cytotoxicity (Branon et al., 2018).

In addition, the conjugation biotin to a protein can hinder modification sites and modify its charge. These parameters can potentially alter attractive interactions involved in protein condensation. Thus, we recommend to verify that the fusion of the protein scaffold to TurboID does not alter its condensation by optogenetic activation.

Target proteins that lack or have hindered primary amine groups will remain undetected. Furthermore, as the labeling radius is about 10 nm, steric hindrances may challenge the labeling of

proximal proteins when TurboID is fused to high molecular weight protein scaffolds. To overcome this limitation, it is possible to increase the size of the linker between the ligase and the scaffold. This will increase the labeling radius and maximize the capture of partner proteins (Kim et al., 2016).

Endogenous biotin levels are elevated in some cell culture conditions. If this is the case, then addition of exogenous biotin will not induce further protein biotinylation (May et al., 2020), and hinder the identification of proteins enriched within biomolecular condensates. Furthermore, high levels of endogenous biotin will promote the labeling of proximal proteins as the scaffold fused to TurboID journeys from the cytoplasm to the nucleus or through mitosis. This will confound the identifications of client proteins that partition within biomolecular condensates.

TROUBLESHOOTING

Problem 1

Poor expression of the scaffold fused to TurboID and Cry2 (step 5)

Potential solution

Verify the integrity of the construct as described in the cloning procedure. If necessary, verify by sequence a different clone, or correct mutations using standard molecular biology approaches. If no mutation is detected, increase the concentration of doxycycline and the time of induction.

Problem 2

The method does not allow delivering the condensates to specific locations (step 6).

Potential solution

The recombinant scaffold may include a sequence of amino-acids that functions as a targeting signal to transport the protein to its appropriate destination. For example, if the recombinant scaffold protein has a nucleo-localization signal, it should localize to the nucleus. Furthermore, the recombinant scaffold may associate with endogenous proteins to form condensates at specific nucleation sites. Alternatively, light-induced hetero-dimerization of CRY2 and CIB1 may be used to control the localization of a protein of interest through protein-protein interaction (Duan et al., 2017). For chromatin - associated condensates, the method may be coupled to a CRISPR-Cas9-based technology to anchor the condensate to a specific locus (Shin et al., 2018).

Problem 3

Chronic biotinylation of the TurboID fusion protein exerts cytotoxicity (step 8).

Potential solution

Use dialyzed FBS to reduce the level of endogenous biotin.

Reduce the time of induction of protein expression with doxycycline.

Reduce the time of incubation with exogenous biotin.

Problem 4

High level of endogenous biotin (step 16).

Potential solution

Use dialyzed FBS to minimize the abundance of endogenous biotin and verify that protein biotinylation is induced by exogenous biotin.

Problem 5

Biotinylation of proximal proteins occurs before condensation (step 23).

Potential solution

The protein scaffold fused to TurboID biotinylates proximal proteins before and after optogenetic induction of biomolecular condensates. The molecular events that arise specifically from the process of condensation, such as posttranslational modifications of proteins, are inferred by comparison with samples prepared before optogenetic activation. The method can be coupled to quantitative mass spectrometry approaches, such as stable isotope labeling with amino acids in cell culture (SILAC), or isobaric tagging reagents for quantitative proteomic analysis (iTRAQ) for high resolution quantitative analyses of condensation-driven protein modifications or protein compartmentalization.

Problem 6

Poor detection of proximal proteins or post-translational modifications (step 46).

Potential solution

Increase the time of incubation with exogenous biotin during optogenetic activation from 15 to 60 min.

Scale up the isolation of biotinylated proteins on streptavidin beads. Increase the amount of proteins loaded on SDS-PAGE gel.

For immunoblotting, use precast polyacrylamide gels, fresh preparations of primary antibody, increase antibody concentration and time of incubation.

RESOURCE AVAILABILITY

Lead contact

Further information and requests for resources and reagents should be directed to and will be fulfilled by the lead contact, Angelos Constantinou (angelos.constantinou@igh.cnrs.fr)

Materials availability

The plasmid generated in this study; pCDNA5_FRT_TO_TurboID-mCherry-Cry2 has been deposited with Addgene under the ID number 166504.

Data and code availability

Original western blot images have been deposited to Mendeley data, <https://doi.org/10.17632/zb35ntwpjx.1>, and are publicly available as of the date of publication. Microscopy data reported in this paper will be shared by the lead contact upon request

ACKNOWLEDGMENTS

This work was supported by la Fondation ARC pour la recherche sur le cancer (PGA1 RF20180206787), the Foundation MSDAvenir, and the SIRIC Montpellier Cancer (grant INCa_Inserm_DGOS_12553).

AUTHOR CONTRIBUTIONS

Conceptualization, J.B. and A.C.; methodology, J.B.; validation, J.B. and A.C.; investigation, J.B. and E.A.; writing original draft, J.B. and E.A.; writing-review & editing, A.C., J.B., and E.A.; visualization, J.B. and E.A.; supervision, J.B. and A.C.; project administration, A.C.; funding Acquisition, A.C.

DECLARATION OF INTERESTS

The authors declare no competing interests.

REFERENCES

- Banani, S.F., Lee, H.O., Hyman, A.A., and Rosen, M.K. (2017). Biomolecular condensates: organizers of cellular biochemistry. *Nat. Rev. Mol. Cell. Biol.* *18*, 285–298.
- Bracha, D., Walls, M.T., and Brangwynne, C.P. (2019). Probing and engineering liquid-phase organelles. *Nat. Biotechnol.* *37*, 1435–1445.
- Bracha, D., Walls, M.T., Wei, M.T., Zhu, L., Kurian, M., Avalos, J.L., Toettcher, J.E., and Brangwynne, C.P. (2018). Mapping local and global liquid phase behavior in living cells using photo-oligomerizable seeds. *Cell* *175*, 1467–1480.e13.
- Branon, T.C., Bosch, J.A., Sanchez, A.D., Udeshi, N.D., Svinkina, T., Carr, S.A., Feldman, J.L., Perrimon, N., and Ting, A.Y. (2018). Efficient proximity labeling in living cells and organisms with TurboID. *Nat. Biotechnol.* *36*, 880–887.
- Duan, L., Hope, J., Ong, Q., Lou, H.Y., Kim, N., McCarthy, C., Acero, V., Lin, M.Z., and Cui, B. (2017). Understanding CRY2 interactions for optical control of intracellular signaling. *Nat. Commun.* *8*, 547.
- Frattoni, C., Promonet, A., Alghoul, E., Vidal-Eychenie, S., Lamarque, M., Blanchard, M.P., Urbach, S., Basbous, J., and Constantinou, A. (2021). TopBP1 assembles nuclear condensates to switch on ATR signaling. *Mol. Cell* *81*, 1231–1245.e8.
- Hyman, A.A., and Simons, K. (2012). Cell biology. Beyond oil and water—phase transitions in cells. *Science* *337*, 1047–1049.
- Kim, D.I., Jensen, S.C., Noble, K.A., Kc, B., Roux, K.H., Motamedchaboki, K., and Roux, K.J. (2016). An improved smaller biotin ligase for BioID proximity labeling. *Mol. Biol. Cell* *27*, 1188–1196.
- Lam, S.S., Martell, J.D., Kamer, K.J., Deerinck, T.J., Ellisman, M.H., Mootha, V.K., and Ting, A.Y. (2015). Directed evolution of APEX2 for electron microscopy and proximity labeling. *Nat. Methods* *12*, 51–54.
- Lyon, A.S., Peeples, W.B., and Rosen, M.K. (2020). A framework for understanding the functions of biomolecular condensates across scales. *Nat. Rev. Mol. Cell Biol.* *22*, 215–235.
- May, D.G., Scott, K.L., Campos, A.R., and Roux, K.J. (2020). Comparative application of BioID and TurboID for protein-proximity biotinylation. *Cells* *9*, 1070.
- Palayam, M., Ganapathy, J., Guercio, A.M., Tal, L., Deck, S.L., and Shabek, N. (2021). Structural insights into photoactivation of plant Cryptochrome-2. *Commun. Biol.* *4*, 28.
- Roux, K.J., Kim, D.I., Raida, M., and Burke, B. (2012). A promiscuous biotin ligase fusion protein identifies proximal and interacting proteins in mammalian cells. *J. Cell Biol.* *196*, 801–810.
- Shin, Y., and Brangwynne, C.P. (2017). Liquid phase condensation in cell physiology and disease. *Science* *357*, eaaf4382.
- Shin, Y., Chang, Y.C., Lee, D.S.W., Berry, J., Sanders, D.W., Ronceray, P., Wingreen, N.S., Haataja, M., and Brangwynne, C.P. (2018). Liquid nuclear condensates mechanically sense and restructure the genome. *Cell* *175*, 1481–1491.e13.
- Youn, J.Y., Dunham, W.H., Hong, S.J., Knight, J.D.R., Bashkurov, M., Chen, G.I., Bagci, H., Rathod, B., MacLeod, G., Eng, S.W.M., et al. (2018). High-density proximity mapping reveals the subcellular organization of mRNA-associated granules and bodies. *Mol. Cell* *69*, 517–532.e1.