



**HAL**  
open science

## Framework and simulation of a phase-based trust management for service-oriented IoT/IIoT

Runbo Su, Arbia Riahi Sfar, Enrico Natalizio, Pascal Moyal, Ye-Qiong Song

► **To cite this version:**

Runbo Su, Arbia Riahi Sfar, Enrico Natalizio, Pascal Moyal, Ye-Qiong Song. Framework and simulation of a phase-based trust management for service-oriented IoT/IIoT. [Technical Report] Loria. 2022. hal-03363098v6

**HAL Id: hal-03363098**

**<https://hal.science/hal-03363098v6>**

Submitted on 1 Apr 2022

**HAL** is a multi-disciplinary open access archive for the deposit and dissemination of scientific research documents, whether they are published or not. The documents may come from teaching and research institutions in France or abroad, or from public or private research centers.

L'archive ouverte pluridisciplinaire **HAL**, est destinée au dépôt et à la diffusion de documents scientifiques de niveau recherche, publiés ou non, émanant des établissements d'enseignement et de recherche français ou étrangers, des laboratoires publics ou privés.

Copyright

# Framework and simulation of a phase-based trust management for service-oriented IoT/IIoT

Runbo Su<sup>\*</sup>, Arbia Riahi Sfar<sup>‡</sup>, Enrico Natalizio<sup>†\*</sup>, Pascal Moyal<sup>§</sup>, and Ye-Qiong Song<sup>\*</sup>

<sup>\*</sup>LORIA, CNRS, Université de Lorraine, France

<sup>‡</sup>STD lab, Military Academy of Tunisia

<sup>†</sup>Autonomous Robotics Research Centre, TII, UAE

<sup>§</sup>IECL, INRIA, Université de Lorraine, France

## I. ORGANIZATION OF THE REPORT

This report aims to present the simulation configuration and performance evaluation of a phase-based trust management framework for service-oriented IoT/IIoT, which is developed from [1]. The rest of this report is organized as follows. Section III details the IIoT plant TM and the inter-plant TM. The simulation results and performance analysis are presented in Section IV.

## II. PROPOSED FRAMEWORK

This section presents the hybrid architecture of proposed TM model, which is suitable for IIoT environment.

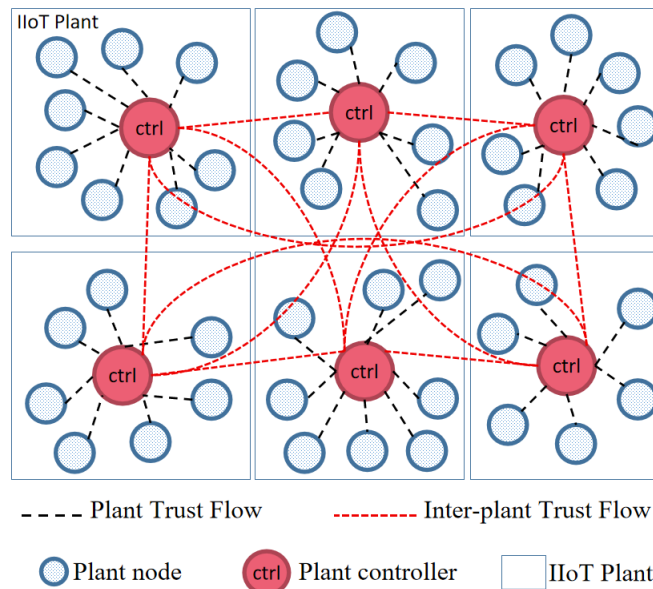

Fig. 1: TM architecture

Fig. 2 demonstrates the proposed architecture of the proposed TM framework with two levels: plant and inter-plant TM. Industrial devices are assembled at the plant level, where nodes in the same plant can participate in cooperative missions to interact in a multi-service environment. Each plant represents an industrial community, and each plant controller is in charge of plant TM as a local responsible entity. Moreover, controllers are networked so that the communication and TM at the inter-plant level are conducted in a distributed manner. Notably, the access control (AC) policy of each plant controller is not identical since plants may have diverse missions, e.g., plants  $p$  and  $m$  may concentrate on raw material treatment and production chain, respectively. Hence, newcomer nodes will be examined much more strictly in those plants with specified demands.

## III. TM MODEL

To illustrate the trust computation of the proposed TM framework, we introduce the plant TM model, first, by detailing each phase. Then, we explain the distinction that the system is able to perform on the nodes that returns to the same plant after some time of inactivity and those that move to a new plant, to complement the AC phase concerning several plants. Lastly, we focus on the TM at the inter-plant level. All notations and acronyms used in this report are gathered in Table I.

TABLE I: Symbol description

SYM	Meaning	SYM	Meaning
SP	Service provider	PR	Parental relationship
SR	Service rater	CWR	Co-work relationship
A	Attribute	SOR	Social relationship
DS	Default score	CN	Connected nodes
SS	Selection score	Des	Description of the node
TS	Trust score	Pre	Prediction of node's return
QSP	Quality of SP	RS <sub>i</sub>	Services rated by <i>i</i>
QSR	Quality of SR	PS <sub>i</sub>	Services provided by <i>i</i>
SG	Service grade	f <sub>ij</sub>	<i>j</i> 's feedback to evaluate <i>i</i>
OSG	Overall SG	$\bar{f}_i$	Average of <i>i</i> 's notes
S	Service	R <sub>-i</sub>	Nodes that rated <i>i</i>
C	Capability	R <sub>i-</sub>	Nodes that rated by <i>i</i>
fct	Function	R <sub>-i</sub> <sup>sn</sup>	Nodes that rated <i>i</i> 's service <i>sn</i>
soc	Social	s_req	Requested service
ctx	Context	S <sub>req</sub>	Requested services in workflow
E	Energy	plt	Current plant
P	Protection	S <sub>plt</sub>	Available services in the plt
US	Usability	$\bar{S}_{plt}$	Unavailable services in the plt
UR	Utilization rate	$\tilde{S}_{plt}$	Services of understaffed case
IS	Initial score	S <sup>fct</sup>	Functional service
G	Centrality	$\bar{S}^{\text{fct}}$	Nonfunctional service
N	Neighbor	C <sup>fct</sup>	Functional capability
CF	Conformity	l	Punishment degree
$\omega, \mu$	Weights	CO	Cooperativeness
$\eta, \varepsilon$		CS	Cooperation score
$\varphi, \kappa$		l	Punishment degree

### A. IIoT Plant TM

1) *Overview of the four phases:* We first detail four phases in plant TM by demonstrating the interactions between TM, service management (SM), and entity management (EM).

Fig. 2 illustrates the phases of TM model consisting of four phases: access control (AC), service provider selection, service evaluation, and node classification. Initially, node identification allows function (fct), social (soc), and context (ctx) attributes (*A*) to be treated in the access control phase in order to generate a default score (DS) as the initial trust score of the newcomer node. Particularly, the AC phase will react with service registration activity in SM to determine the functional services ( $S^{\text{fct}}$ ) of the node by validating the node's capabilities [2]. Once a service request has been received and confirmed by the plant controller, service discovery activates the service composition (COMP) step, where the request mission can be depicted as a workflow composed by services registered. Next, the SP selection phase ranks available SP by calculating the selection score (*SS*) on the basis of the service composition and nodes' service grade (*SG*), and the controller transmits the operational command to the authorized SP with great selection score (*SS*) to start the service provision. After that, the feedback from service consumers will be collected to support the service evaluation phase that calculates trust score (*TS*), quality of service rater (*QSR*), provider (*QSP*), and *SG*. Eventually, based on the trust values issued from the last two phases (service evaluation and node classification), service registration updates service types according to current *SG*, and those badly-performed nodes must be isolated based on the result of node classification phase. The blue circles are to indicate the cycles of phases.

The diagram in Fig. 2 gives an overview of how the proposed TM model works with EM and SM. We suggest a TM model that is applicable since the three blocks in SM are key activities in SOA, as previously discussed already, and the control system can carry EM out, while it conducts device identification, issues operational commands to plant nodes, and gathers their feedback after the service provision ends. From this diagram, it can also be seen that the proposed TM model enables to monitor and evaluate behaviors of IIoT plant nodes dynamically, and can connect and interact with EM and SM to support the IIoT environment.

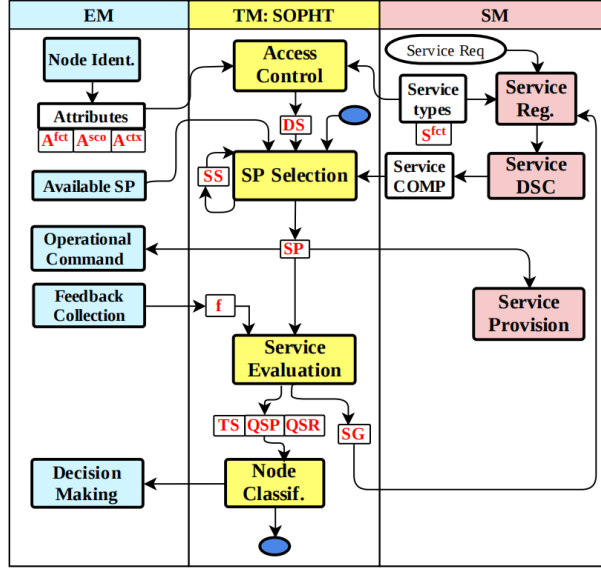

Fig. 2: Relationships between EM, TM, and SM

2) *Access Control*: Recording the node by its asserted attributes is more advantageous in terms of security [3], and ABAC (attribute-based access control) is considered a logical methodology for AC in IIoT [4]. For defining permissions in AC phase, we are concerned with the three types of attributes: function (fct), social (soc), and context (ctx). Fix a node  $i$  until the end of the section. The set of attributes of node  $i$  is denoted as

$$A_i = \langle A_i^{\text{fct}} | A_i^{\text{soc}} | A_i^{\text{ctx}} \rangle. \quad (1)$$

**Function attribute** ( $A^{\text{fct}}$ ) indicates the capabilities ( $C$ ) of the node. By validating nodes' capabilities, the functional services ( $S^{\text{fct}}$ ) will be classified and extracted, as demonstrated in Fig. 2, and those capabilities that are deployed to conduct  $S^{\text{fct}}$  are identified as functional ones  $C^{\text{fct}}$ . The assignment of the initial score to the newcomer depends on two aspects: usability ( $US$ ) and utilization rate ( $UR$ ). In the industrial context, the newcomer node falls into two broad categories, related to the service: either it can provide new functionalities that the current plant does not have (thereafter referred as 'newness'), or it meets the need of the current plant, due to the heavy workload (thereafter referred as 'understaffed'). Thus, the  $US$  measures if the current plant needs the newcomer node by analysing its  $S^{\text{fct}}$ , and the  $UR$  calculates the ratio between the functional capabilities and all the capabilities (functional and nonfunctional) of the node in order to determine if, in terms of missing capabilities, the node should be deployed.

**Social attribute**  $A^{\text{soc}}$ : Although social features are widely studied in Social Internet of Things (SIoT), the IIoT nodes also have such features, since they interact with each other, share data, and collaborate for service provision. In our model, we consider three main object relationships [5]: parental ( $PR$ ), co-work ( $CWR$ ), and social ( $SOR$ ) relationships. Nodes belonging to the same manufacturer have higher  $PR$ , as their functional characteristics are somehow approximated. We measure the similarity of functional services of nodes because the  $CWR$  value increases when nodes have more opportunities to cooperate in service. The contact between nodes comes randomly, continuously, or periodically, and thus  $SOR$  is used to indicate the interactivity between nodes.

**Context attribute** ( $A^{\text{ctx}}$ ) describes the relevant contextual information that can be used as security characteristics [6]. Here, we consider two environmental conditions: energy ( $E$ ) and protection ( $P$ ).  $E$  refers to the power source of the node such that it can somehow show device life-cycle information since nodes often suffer from constrained resources, and  $P$  demonstrates the importance of the establishment of physical protection.

Based on the three types of attributes of the newcomer node, the AC phase can assign it an initial trust value by (13) before the newcomer node participates in the SP selection.

a) *DS of function attribute*:  $DS_i^{\text{fct}}$  defined by

$$DS_i^{\text{fct}} = US_i \cdot UR_i, \quad (2)$$

where

$$US_i = \begin{cases} 1, & \text{if } S_i^{\text{fct}} \cap \overline{S_{\text{plt}}} \neq \emptyset \text{ or } S_i^{\text{fct}} \cap S_{\text{plt}} \neq \emptyset \\ 0, & \text{otherwise} \end{cases} \quad (3)$$

and

$$UR_i = \frac{|C_i^{\text{fct}}|}{|C_i|}. \quad (4)$$

We now define  $S_{\text{plt}}$  that represents the available functional services in the plant plt:

$$S_{\text{plt}} = \bigcup_{k \in CN} S_k^{\text{fct}}, \quad (5)$$

where  $CN$  denotes the connected nodes in the current plant. In (3),  $\overline{S_{\text{plt}}}$  is the set of functional services unavailable in the current plant, and  $S_{\text{plt}}^{\sim}$  represents the services of understaffed case. Thus,  $S_{\text{plt}}^{\sim} \subseteq S_{\text{plt}}$ . In (4),  $|C|$  denotes the cardinality of the set  $C$ .

b) *DS of social attribute*:  $DS_i^{\text{soc}}$  defined by

$$DS_i^{\text{soc}} = \mu^{PR} PR_i + \mu^{CWR} CWR_i + \mu^{SOR} SOR_i, \quad (6)$$

where  $\mu^{PR} + \mu^{CWR} + \mu^{SOR} = 1$ ,

$$PR_i = \frac{1}{|CN|} \sum_{k \in CN} v_{ik}^{PR}, \quad (7)$$

$$CWR_i = \frac{1}{|CN|} \sum_{k \in CN} \frac{|S_i^{\text{fct}} \cap S_k^{\text{fct}}|}{|S_i^{\text{fct}} \cup S_k^{\text{fct}}|}, \quad (8)$$

and

$$SOR_i = \frac{1}{|CN|} \sum_{k \in CN} v_{ik}^{SOR}. \quad (9)$$

In (7), (8) and (9),  $v^{PR}$  and  $v^{SOR}$  are binary values describing if they belong to same production batch and if the their interaction is adaptable in terms of their software specification, respectively.

c) *DS of context attribute*:  $DS_i^{\text{ctx}}$  defined by

$$DS_i^{\text{ctx}} = \frac{1}{2} \cdot (E_i + P_i), \quad (10)$$

where

$$E_i = \begin{cases} 1, & \text{for mains-powered} \\ \frac{D_i^{\text{res}}}{D_i}, & \text{for other power source} \end{cases} \quad (11)$$

and

$$P_i = \begin{cases} 1, & \text{if physically protected} \\ 0, & \text{otherwise} \end{cases} \quad (12)$$

In (10), we weight the sum of  $E$  and  $P$  by 1/2 because they are regarded equally critical as contextual information. For the calculation of  $E$  in (11), all power source types take the ratio of residual durability ( $D_{\text{res}}$ ) and durability ( $D$ ), except mains-powered ones take 1. In (12),  $P$  takes a binary value indicating if the node is protected physically, e.g., in a secure zone.

d) *DS computation*: With three sub-DS values calculated by (2-10), the DS of node  $i$  can be calculated as follows:

$$DS_i = \omega^{\text{fct}} \cdot DS_i^{\text{fct}} + \omega^{\text{soc}} \cdot DS_i^{\text{soc}} + \omega^{\text{ctx}} \cdot DS_i^{\text{ctx}}, \quad (13)$$

where  $\omega^{\text{fct}} + \omega^{\text{soc}} + \omega^{\text{ctx}} = 1$ . Newcomer node is permitted to entry if its  $DS > 0.5$ , and then the controller generates a description ( $Des$ ) by adding trust score fields, functional and nonfunctional services ( $S^{\text{fct}}$  and  $S^{\text{nfct}}$ ), and service grade ( $SG$ ) after the attributes  $A$  as follows:

$$Des_i = \langle A_i | TS_i | QSP_i | QSR_i | S_i^{fct} | S_i^{\overline{fct}} | SG_i \rangle. \quad (14)$$

The newcomer node is prohibited from requesting services unless the controller designates it to consume services. Furthermore, it will not be evaluated by the controller in the service evaluation phase since it has neither rated nor provided services. Thus,  $TS$ ,  $QSR$  and  $SG$  are all null.  $DS$  is filled into  $QSP$  in order to have an initial level to compete for the service provider selection.  $S_i^{\overline{fct}}$  is initially empty but will be employed when any  $S_i^{fct}$  of the node are adjudicated ineligible. Lastly, this description will be stored into the list of current nodes ( $CN$ ).

3) *Service provider (SP) selection:* Upon receiving a service/mission request directly from the controller or from the node whose  $QSR > 0.5$ , the service discovery activity will commence with the service composition process while some missions require a workflow that searches and interconnects services [7].

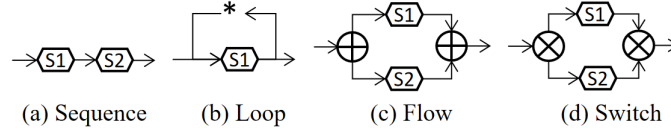

Fig. 3: Constructs for workflow

Fig.3 illustrates commonly-used service composition constructs, including sequence  $\rightarrow$  (s1, then s2), loop  $*$  (s1 several times), flow  $\oplus$  (s1 and s2), and switch  $\otimes$  (s1 or s2).

If the workflow allows numerous nodes to take part in the service composition, the essential method is still looking for the best-ranked candidate nodes with outstanding  $SG$ , this remains the same scheme for single service requested. For a workflow dedicated to one node, to have better continuity for example,  $SG$  of single service type cannot accurately signify the trustworthiness of services requested in the workflow (denote as  $S_{req}$ ). Thus, an overall opinion for the workflow should be estimated as well. The calculation of overall  $SG$  ( $OSG$ ) is given in (15), and the  $r$  for loop  $*$  represents the number of repetition.

$$OSG_i = \begin{cases} \prod_{s_n \in S_{req}} SG_i^{s_n}, & \text{for } \rightarrow \\ (SG_i^{s_n})^r, & \text{for } * \\ 1 - \prod_{s_n \in S_{req}} (1 - SG_i^{s_n}), & \text{for } \oplus \\ \max_{s_n \in S_{req}} (SG_i^{s_n}), & \text{for } \otimes \end{cases} \quad (15)$$

Next, the controller can generate a ranking of selection scores ( $SS_i$ ), calculated as follows:

$$SS_i = \begin{cases} QSP_i \cdot OSG_i, & \text{for a workflow} \\ QSP_i \cdot SG_i^{s_{req}}, & \text{for a single service} \\ QSP_i, & \text{if newcomer} \end{cases} \quad (16)$$

The examination of the candidate SP in (16) concerns two sides:  $QSP$  gives the opinion from a more general view, e.g., the stability (refer to section Section III-A4c); and  $SG/OSG$  measures the specialty of the SP, which determines the feasibility of that SP can accomplish the dedicated service/mission. The node with poor  $QSP$  or  $SG/OSG$  will obtain a low value for  $SS$ . Due to the fact that the controller selects only the best-ranked candidates with significant  $SS$ , those of low rank barely have the opportunity to assist in service provision.

As discussed in Section III-A2, there are two cases when the newcomer access control occurs: newness or understaffed. The SP selection is lightweight in the first case, since only the newcomer will provide the requested service. For the second case, the SP selection concerning newcomers must be started after all other candidates have been assigned some missions.

4) *Service evaluation:* In the service evaluation phase, the trustworthiness of nodes will be measured by four metrics, namely trust score ( $TS$ ), quality of service rater ( $QSR$ ), quality of service provider ( $QSP$ ), and service grade ( $SG$ ).  $TS$  gives an

overall opinion on the basis of  $QSP$  and  $QSR$ , and  $SG$  corresponds directly to the quality of each service type. The feedback originated from service consumer (thereafter referred as 'service rater')  $j$  to rate the service quality of the service provider  $i$  is in the range of  $[0, 1[$  (0 means no service conducted from service provider) and denoted as  $f_{ji}$ . To precise the workflow cases, the feedback should be gathered after every service provision of each service, i.e., the number of feedback from one SR and the number of services consumed by it must be equal, whatever the service composition is.

a) *Trust score (TS)*: We set

$$TS_i = \frac{|RS_i|}{|RS_i + PS_i|} \cdot QSR_i + \frac{|PS_i|}{|RS_i + PS_i|} \cdot QSP_i, \quad (17)$$

where  $RS_i$  and  $PS_i$  denote the services rated and provided by the node  $i$ , respectively, and  $QSR_i$  and  $QSP_i$  are given by (18) and (20). It can be seen that a node has two roles: service rater (SR) and service provider (SP). This means the evaluation of a node depends on the behavior of both roles, e.g., a reputable SP may be dishonest when rating others' services; likewise, an excellent SR may be terrible at service provision. That is also the reason that we deploy the quantity parameter to weight (17). In such a way, the quality and quantity impact of  $QSR$  and  $QSP$  can be carried out accurately to assess the trustworthiness of the node as both SR and SP.

b) *Quality of service rater (QSR)*:

$$QSR_i = \varphi \cdot CQSR_i + (1 - \varphi) \cdot LQSR_i, \quad (18)$$

where  $\varphi$  belongs to  $[0.5, 1[$ .  $CQSR$  and  $LQSR$  are current and last values of  $QSR$ . We put  $QSR=CQSR$  for newcomers since they do not possess any rating records. The  $CQSR$  in (18) is computed as follows:

$$CQSR_i = 1 - \frac{1}{|R_{i-}|} \sum_{j \in R_{i-}} |f_{ij} - \bar{f}_j|^{1/l}, \quad (19)$$

where  $R_{i-}$  represents the set of nodes that rated by  $i$  in the service evaluation phase,  $\bar{f}_j$  is the average value of feedback evaluating node  $j$ , and the little  $l$  is the punishment degree such that the dishonesty will be amplified.

Indeed, the calculation of  $QSR$  is based on the comparison between the opinions of the rater node and the average value of other raters, which enables to distinguish the dishonest service raters by identifying the gap in this comparison. In IIoT, the feedback  $f_{ij}$  from  $i$  to evaluate  $j$  can emerge by a predefined measurement scheme that is objective, thus it will not have a large variance, as such in SIoT, due to the user preference or environmental perturbation. Therefore, an unfair rating from a dishonest rater that either ruins a well-behaved node's reputation (BMA) or boosts a misbehaved node's reputation (BSA), can be detected.

c) *Quality of service provider (QSP)*:

$$QSP_i = \varepsilon \cdot CQSP_i + (1 - \varepsilon) \cdot LQSP_i, \quad (20)$$

where  $\varepsilon$  is set in the range  $[0.5, 1[$ , to weight the current value ( $CQSP$ ) and the last value ( $LQSP$ ). We put  $LQSP=DS$  for newcomers, and it is reasonable since we set  $DS$  to  $QSP$  for newcomer nodes in the AC phase. The  $CQSP$  in (20) is calculated as follows:

$$CQSP_i = \frac{1}{|R_{-i}|} \sum_{j \in R_{-i}} \theta_{ji} \cdot \lambda_{ji} \cdot QSR_j \cdot f_{ji}, \quad (21)$$

where  $R_{-i}$  represents the set of nodes that rated services from  $i$ ,  $\theta$  and  $\lambda$  are stability parameters against OOA and CBA, respectively given by (22) and (23).

$$\theta_{ji} = \text{sinc}(1 - f_{ji}) \cdot \text{sinc}(\Delta f_{ji})^{\Delta t}, \quad (22)$$

$$\lambda_{ji} = 1 - |f_{ji} - \bar{f}_i|^{1/l}. \quad (23)$$

In (22),  $\Delta t$  and  $\Delta f_{ji}$  are time gap and difference of last feedback ( $lf_{ji}$ ) and present feedback ( $cf_{ji}$ ), i.e.,  $\Delta t = t_{cf_{ji}} - t_{lf_{ji}}$  and  $\Delta f_{ji} = |cf_{ji} - lf_{ji}|$ , we set both to 0 for newcomers. The (normalized) sinc function is defined as

$$\text{sinc}(x) = \begin{cases} 1, & \text{for } x = 0 \\ \frac{\sin(\pi x)}{\pi x}, & \text{for } x \neq 0 \end{cases} \quad (24)$$

We choose the latter mapping in (22) because it is continuous at point 0, and maps  $[0, 1]$  onto  $[0, 1]$  with inflexions that can be used to penalize the large  $\Delta f_{ji}$  and poor  $f_{ji}$ . The unstable behaviors over time is penalized by use of  $\theta_{ji}$ , since it is increasing in  $\Delta f_{ji}$ , with an exponent  $\Delta t$  that renders unacceptable any drastic changes in service quality. In (23),  $\bar{f}_i$  is the average value of  $i$ 's notes rated by other rater nodes and  $l$  is the punishment degree as same in (19). In other words, conflicting behavior

will be captured due to  $\lambda$  that compares the service quality to each individual with the average level. By the very definitions of the  $\theta$  and  $\lambda$  coefficients, the unique possibility for the node to earn reputation, is to keep steadily providing satisfying services.

d) *Service grade (SG)*: To evaluate the service quality of type  $n$  ( $s^n$ ), the service grade  $SG_i^{s^n}$  is computed as follows:

$$SG_i^{s^n} = \kappa \cdot CSG_i^{s^n} + (1 - \kappa) \cdot LSG_i^{s^n}, \quad (25)$$

where

$$CSG_i^{s^n} = \frac{1}{|R_{-i}^{s^n}|} \sum_{j \in R_{-i}^{s^n}} QSR_j \cdot f_{ji}^{s^n}, \quad (26)$$

where  $R_{-i}^{s^n}$  is the set of nodes that rated the  $s^n$  provided by  $i$  and  $f_{ji}^{s^n}$  denotes the feedback from  $j$  for  $s^n$  provided by  $i$ , i.e., we identify the service type that the feedback indicated. Notably,  $SG^{s^n} = CSG^{s^n}$  for newcomer nodes.  $SG$  is used to observe specifically the service quality of each type that is marked as 'functional' since the AC phase, i.e., if any single type of  $S^{fct}$  gets a low value of  $SG$ , it will be regarded 'nonfunctional' service and cannot provide such service type anymore. Accordingly, this service type will be relocated from  $S^{fct}$  to  $S^{\overline{fct}}$ .

The set of all service grades will be updated in each service evaluation phase and it is defined as follows:

$$SG_i = \{SG_i^{s^n} | s^n \in (S_i^{fct} \cup S_i^{\overline{fct}})\} \quad (27)$$

As a result of the calculation in (27), the  $SG^{s^n}$  will decrease if a node persists in providing unsatisfying service on particular type  $n$ . After that  $SG^{s^n} < 0.5$ , the plant controller must label this service type as malfunctioning and immediately remove it from  $S^{fct}$ . After the removal, the service is put into the  $S^{\overline{fct}}$ , in order to prohibit the node from being selected as SP for the service type  $n$ , and alert other plants in case of need, e.g., when a node moves to another plant. Hence, the misbehavior aiming at service types from malicious SP, namely SBA, will be authorized to provide fewer and fewer service types due to the  $SG$  mechanism. Finally, two situations come to such node, either it performs well for the other service types to stay in the current plant, or it progressively loses its competitiveness for the SP selection, and eventually it will be eliminated from the plant.

5) *Node classification*: By classifying the values of  $TS$ ,  $QSP$  and  $QSR$  under good ( $>0.5$ ) and bad ( $\leq 0.5$ ), the node classification scheme illustrated in Fig. 6 enables the controller to categorize nodes into 6 groups:



Fig. 4: Node classification scheme

- Good node (GN): This kind of node will surely stay in the current plant since its  $TS$ ,  $QSP$ , and  $QSR$  are all at a good level.
- Weak service rater (WSR): WSR will be banned from requesting services as the  $QSR$  is ineligible for rating of the service.
- Weak service provider (WSP): Different from the treatment of WSR, a WSP node is not deprived of anything. However, it has been categorized into WSP because of its low  $QSP$ , thus, it has little chance to be picked since its  $QSP$  induces incompetence.
- Bad service rater (BSR)/unfair rating attacker (URA): It is difficult to determine precisely if this node is just incapable or malicious, but, in any of the two cases, the controller must eliminate the node in order to minimize the adverse effects of erroneous ratings from the controller's view.
- Bad service provider (BSP)/inconsistent behavior attacker (IBA): Analogously, SP belonging to this group may be simply unreliable in terms of service quality or may be an attacker who misbehaves. In any of the two cases, the controller must eliminate the node.



- Malicious node (MN)/mixed type attacker (MTA): It is the worst case among the node classification as all three metrics consisting  $TS$ ,  $QSP$ , and  $QSR$  are bad. The controller must remove a node belonging to this group immediately.

In fact, the reason why WSP and WSR nodes are not isolated from the network is because their  $TS$  values remain good, i.e., they still have some valuable aspects that can benefit the current plant from a global perspective.

### B. Returning to the same plant/moving to a new plant case

Fig.6(a) demonstrates how a newcomer is managed and registered. However, it is worth noting that, in IIoT, there are other possibilities besides the newcomer case. For instance, a device whose power source is rechargeable will be disconnected for recharging and then reconnected to the network. In order to keep the reputation of such node consistent throughout the recharging operation and prevent an undesirable node to whitewash its reputation (namely NCA), this type of node should be treated as a returner rather than as a newcomer.

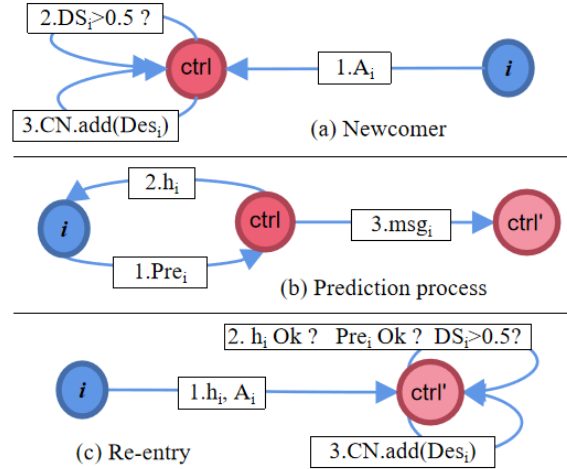

Fig. 5: Checking mechanism and prediction process

For this purpose, the node must inform the plant controller of the prediction for its return in the following form:  $Pre_i = \langle ctrl' | loc' | t' \rangle$ . The prediction contains target controller ( $c'$ ), location ( $loc'$ ), and time ( $t'$ ). After the prediction is accepted, the current controller will generate a message combining the prediction and the description of the node as follows:  $msg_i = \langle Pre_i | Des_i \rangle$ , and this message will be transmitted to the target controller ( $ctrl'$ ) as announced in  $Pre_i$ . Next, the current controller assigns a value to the node, that is converted by one-way hash function  $h_i = \text{Hash}(msg_i)$ . This prediction process is illustrated in Fig.6(b).

Fig. 6(c) describes the re-entry case, where the node should send the target controller ( $ctrl'$ ) the hash value ( $h_i$ ) received in the prediction process, then the target controller will collect attributes of this node and verifies the satisfaction of the three following conditions. First, the target controller investigates the hash value with the aid of the message from the original controller of the node, i.e., if  $h_i == \text{Hash}(msg_i)$ . Second, the target controller checks if the information in prediction containing target controller ( $c'$ ), location ( $loc'$ ), and time ( $t'$ ), matches the entry of the node. Finally, the target controller analyses the attributes of the node and calculates the  $DS$  to decide if the node is permitted to enter the plant. As a policy for the returner, nodes from the same plant can continue to be assessed by the previous trust values; and nodes from other plants can only hold their previous  $QSR$ , if their  $QSR > 0.5$ . In such manner, there is a sort of continuity in TM to benefit the returners. Furthermore, the target controller can utilize  $SG$ ,  $S^{fct}$ , and  $S^{fct}$  in  $Des$  to help the service registration activity to discern if a node fakes its capabilities. Therefore, using the triple checking rule illustrated in Fig. 6(c), the AC phase enables to distinguish the node that returned to the same plant, and the node that has moved to a new plant.

An NCA attacker attempts to re-enter the original plant or a new plant to obtain a refreshed trust score, but doing so very likely it makes its  $DS$  lower, as the AC phase is inherently dynamic, and the node is not aware of the service types. Furthermore, in the SP, the newcomers are always placed after the current active nodes in the plant, i.e., the newcomers have to earn the reputation after their entry. Hence, the NCA attacker's purpose of leaving the plant and then returning to refresh its trust scores is unachievable.

### C. Inter-plant TM

1) *Overview of phases:* Unlike the plant TM, there is no service provision or rating at the inter-plant level but service migration (node moving to a new plant case). Therefore, the main objective of the inter-plant TM is to identify 'unfriendly' plants that may endanger the current plant security by sending malicious nodes. For this purpose, we design a simple three-phase mechanism for inter-plant TM. The evaluated plant shares its service types ( $S$ ) and neighborhood situation ( $N$ ) with

the evaluator plant in the initial evaluation phase to issue an initial score ( $IS$ ). In cooperation evaluation phase, the evaluator observes the cooperativeness of the evaluated one and calculates the cooperation score ( $CS$ ) by analysing the behaviors of the nodes moving to a new plant from the evaluated plant. Finally, the evaluated plant will be classified in the plant classification phase based on the  $CS$  obtained.

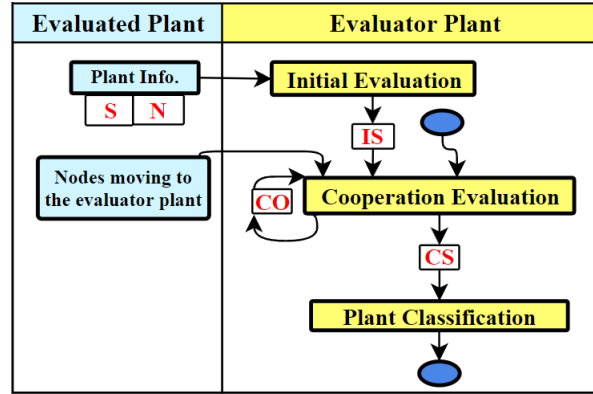

Fig. 6: Interaction between the evaluated and evaluator plants and three phases of inter-plant TM

2) *Initial evaluation*: For the initial evaluation, we set centrality ( $G$ ) and conformity ( $CF$ ) as trust metrics with equal importance:

$$IS_{mp} = \frac{1}{2} \cdot (G_{mp} + CF_{mp}), \quad (28)$$

Thus, the initial score ( $IS$ ) describes the closeness of two plants in terms of service and location, and hence the evaluator plant can have a initial threshold of cooperation.

Centrality

$$G_{mp} = \frac{N_{mp}}{|N_m \cup N_p|}, \quad (29)$$

where  $N_p$  denotes the set of neighbors of  $p$ , and  $N_{mp}$  is a binary value describing if plants  $m$  and  $p$  are neighbors. The centrality  $G$  measures the relationship between plants from a co-location perspective, since industrial plants with high relevance or similarity are generally arranged close to each other. Thus, the term 'neighbor' means geographically close: A plant  $m$  within a certain distance can be considered as a neighbor of the plant  $p$ .

Conformity

$$CF_{mp} = \frac{|S_m \cap S_p|}{|S_m|}, \quad (30)$$

where  $S_m$  and  $S_p$  denote respectively all functional services needed in plants  $m$  and  $p$ . To differentiate with the  $S_{plt}$  utilized in Section III-A2,  $S_{plt}$  denotes the available function services in the current services. The conformity  $CF$  examines the similarity of two plants in terms of community interest, and in such a way, they become complementary if this value is considerable. For instance, in case that plants  $p$  and  $m$  have high  $PCF$ , a sudden failure of a service type comes to plant  $p$ , and it can immediately ask plant  $m$  to help by sending nodes providing that service type.

3) *Cooperation evaluation*: After the initial evaluation phase, plants can interact with each other. This would make the nodes that moved to a new plant emerge, in order to deal with the 'newness' or 'understaffed' issues. When a plant requires another one to send nodes that provide functional services, these nodes may misbehave in the AC phase or service provision. By implementing the plant TM mechanism discussed before, the malicious nodes from other plants can be detected and removed, but the conclusion remains at the level of nodes, i.e., no evidence to confirm the role of the node-sender plant, especially if it has been compromised. For this reason, the cooperation evaluation should take into consideration the observation of nodes coming from other plants to determine the nature of the plant.

As stated already, the nodes that move to a new plant may behave badly in the AC phase or service provision, therefore, we measure the number of good nodes out of all those that moved to the new plant:

$$CO_{mp} = \frac{GN_{pm} + 1}{MNP_{pm} + 2}, \quad (31)$$

where  $GN_{pm}$  represents the good nodes (defined by the node classification scheme) from  $p$  to  $m$ ,  $MNP$  (moved to new plant) are all the nodes that moved to the new plant. Cooperativeness describes the willingness of the evaluated plant sending nodes with functional services.

The cooperation score ( $CS$ ) of  $p$  evaluated by  $m$  can be computed in an iterative way, as follows:

$$CS_{mp} = \begin{cases} IS_{mp}, & \text{before any interactions} \\ \eta^{CO} \cdot CO_{mp} + \eta^{IS} \cdot IS_{mp}^\alpha, & \text{otherwise,} \end{cases} \quad (32)$$

where  $\alpha = 1/LCO_{mp}$ , for  $LCO_{mp}$  the last  $CO_{mp}$  value, and  $\eta^{IS} + \eta^{CO} = 1$ .  $IS_{mp}$  given in the initial evaluation phase is somehow regarded as a threshold since two close plants should cooperate more, but a gap may emerge between the threshold and the reality that a plant with great  $IS$  can still send malicious nodes. Thus, the  $\alpha$  is designed as a punishment parameter by amplifying the gap between the  $IS$  and  $CO$ .

4) *Plant classification*: With the  $CS$  value, Fig 7 classifies the evaluated plant into two groups: convenient plant (CP) and distant plant (DP).

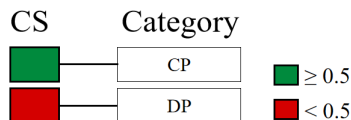

Fig. 7: Plant classification scheme

Consequently, the evaluator plant will reduce the communication frequency with the evaluated plants whose  $CS$  value is low since their interactions are considered valueless after the calculation. On the other hand, the evaluated plants with great  $CS$  value have higher priority for the evaluator plant when looking for support, since the evaluated plant is more profitable than others.

#### IV. SIMULATION

This section analyses the simulation results and verifies the effectiveness of the proposed TM framework by using MATLAB platform.

##### A. Simulation parameters setup

TABLE II: Simulation parameters values

Parameter	Value	Parameter	Value
$\omega^{\text{soc}}, \omega^{\text{ctx}}$	0.2	$\omega^{\text{fct}}$	0.6
$\mu^{PR}, \mu^{SOR}$		$\mu^{CWR}$	
$\eta^{IS}$		$\eta^{CO}$	0.8
$\varepsilon, \varphi, \kappa$	0.5	$l$	2

As illustrated in Table II, we set  $\omega^{\text{fct}}$  and  $\mu^{CWR}$  0.6 because they are regarded as more relevant than other parameters with respect to the need of services in the current plant. Similarly, for  $\eta^{CO}$ , we set 0.8 since it is considered as significant to demonstrate the cooperativeness between plants. Respecting the constraints of  $\mu^{PR} + \mu^{CWR} + \mu^{SOR} = 1$ ,  $\omega^{\text{fct}} + \omega^{\text{soc}} + \omega^{\text{ctx}} = 1$ , and  $\eta^{IS} + \eta^{CO} = 1$ , we consider other parameters identically critical and thus assign them all 0.2.  $\varepsilon$ ,  $\varphi$ , and  $\kappa$  are given 0.5 for the reason that the last and the current evaluations are equally important. Finally, the punishment degree  $l$  is set to 2. Other simulation configurations concerning plant and inter-plant TM are given in Sections IV-B and IV-C, respectively.

##### B. Plant TM

In the simulations of the plant TM, we focused on observing the trustworthiness within one single IIoT plant. Table III illustrates the simulation configuration of the plant TM, and the service types and capabilities are numbered to simplify the representations. In the current plant, there are 29 nodes belonging to 8 types as CN, and their trust values are all set to a

random value in the range of  $[0.9 \ 0.95]$ <sup>1</sup>. For the service composition, we randomly select 1 out of 5 possibilities (single,  $\rightarrow$ ,  $*$ ,  $\oplus$ , and  $\otimes$ ), where  $\rightarrow$ ,  $\oplus$ , and  $\otimes$  contain 2 service types each (excluding  $s_4$  since understaffed). In addition,  $r=2$  for  $*$  case. Finally, only 1/2 of candidate SP can participate in the final service provision ((candidate SP+1)/2 if odd), and service consumers are all nodes that are not candidates to involve more SR.

TABLE III: Configuration of plant TM simulation

Conf.	Description
Controller	Single one
Service types	$s_1 \sim s_3$ -general, $s_4$ -understaffed, $s_5$ -newness
Capabilities	Predefined $c_1 \sim c_{14}$ , refer to Table V
Node type	Predefined $t_1 \sim t_{12}$ , refer to Table V
Num of nodes	$(t_1 \sim t_7) \times 4 + 8 \times 1 = 29$ CN; $(t_9 \sim t_{12}) \times 1$

INIT = Initialization, Num = Number

1) *Access control*: Two aspects of the AC phase performance will be analysed: the calculation of  $DS$  values and the demonstration of returning/moving to a new plant cases.

a) *DS calculation*: As defined in Tables III and V, only the CN node of  $t_8$  is able to provide  $s_4$ , and  $s_5$  is a new service that the current plant needs. On the one hand, we set  $t_9$  and  $t_{10}$  to demonstrate the AC phase for 'understaffed' and 'newness' cases. On the other hand,  $t_{11}$  has no service identified as functional, and  $t_{12}$  possesses too many capabilities, in fact its  $UR$  (utilisation rate) is too low to let it enter.

TABLE IV: Service Registration through capabilities of nodes

S	1	2	3	4	5						
C	1	2	3	4	5	6	1	7	2	5	8

TABLE V: CN nodes and newcomers with their attributes utilized

Type	CN	C	S	ssp	PB	E	PT
t1	Y	-	1	a,b	i	-	-
t2	Y	-	1,2	b	i	-	-
t3	Y	-	1,2,3	a,b,c	i	-	-
t4	Y	-	1,3	a	i	-	-
t5	Y	-	2	a,c	j	-	-
t6	Y	-	2,3	b	j	-	-
t7	Y	-	1,3	a	j	-	-
t8	Y	-	1,4	a,b,c	i	-	-
t9	N	1,2,3,7	1,2,4	b	i	R	N
t10-1	N	2,4,5,8	5	a	j	MP	N
t10-2	N	2,4,5,8	5	a	j	R	N
t11	N	4,8	/	a,b,c	j	MP	Y
t12	N	2,5,8,9,10, 11,12,13,14	5	a,b,c	j	MP	Y

MP = Mains-powered, ssp = Software Specification  
PB = Production Batch, R = Rechargeable

Table VI illustrates the  $DS$  calculation of  $t_9 \sim t_{12}$  nodes. Note that the CN list remains unchanged for each entry.  $t_9$  obtains 0 for  $DS^{ctx}$ , but it has a significant  $DS^{fct}$  value since it provides  $s_4$  and all of its capabilities can be deployed. In addition, its  $DS^{soc}$  is relatively higher than other types of nodes because it has more chances to cooperate and interact with other CN due to its 3 service types. Similarly,  $t_{10-1}$  and  $t_{10-2}$  have great values of  $DS^{fct}$ , due to the new service  $s_5$ . Since their capability  $c_4$  is unusable, their  $UR < 1$ . The reason why  $t_{10-1}$  entered but  $t_{10-2}$  did not, is that  $t_{10-1}$  is mains-powered. Although  $t_{11}$  and  $t_{12}$  are all given 1 for  $DS^{ctx}$ , and their  $ssp$  contains all types to communicate with other nodes, they cannot enter since  $t_{11}$  has no functional services and  $t_{12}$  is considered insufficient specified for the current plant due to low  $UR$ . Indeed, the  $DS$  calculation of  $t_{12}$  also shows the dynamicity and resilience of the AC phase: NCA attackers attempting to fake their capabilities to increase its  $DS^{fct}$  may decrease their  $UR$  and  $CWR$  because of less functional services identified. Considering  $DS$  values as illustrated in Table VI, the policy of the AC phase is strict: Only  $t_9$  and  $t_{10-1}$ , namely understaffed and newness cases, received considerable  $DS^{fct}$  values. Furthermore,  $t_9$  and  $t_{10-1}$  both have relatively low  $DS$  values, which is in line with their newcomer status, i.e., they should earn reputation to improve their trustworthiness.

<sup>1</sup>Please, refer to Tables IV for the service type validation process through the capabilities of nodes.

TABLE VI: DS values for newcomers of types 9~12

DIG	9	10-1	10-2	11	12
$DS^{fct}$	1	0.75	0.75	0	0.3750
$DS^{soc}$	0.4894	0.2	0.2	0.2552	0.2552
$DS^{ctx}$	0	0.5	0	1	1
DS	0.6979	0.59	0.49	0.2410	0.4760
Decision	Y	Y	N	N	N

b) *Returning to the same plant/moving to a new plant case:* We set here all nodes are good nodes (GN), and they are all honest and will give  $0.95 \pm 0.05$  (noise)<sup>2</sup> to rate the satisfactory services. We chose the t9 node as the newcomer to simplify the visualization of the changes in trust values, i.e., the controller forces this node to provide  $s4$  and to rate other nodes' services at the same time.

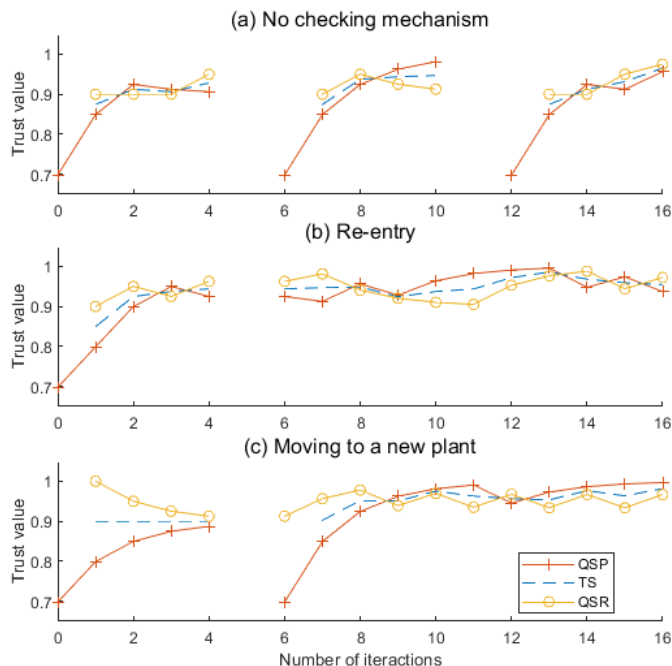

Fig. 8: Changes in trust values in three scenarios of the AC

In Fig. 8(a), without checking mechanism, t9 node suffers from gaining reputation after its re-entry even though its trust values remain great before it quits. Differently, Fig. 8(b) gives an example that the t9 node benefits from all previous trust values since it is treated as a returner rather than a newcomer. Lastly, in moving to a new plant case, t9 node can only continue using its  $QSR$  value.

2) *SP selection:* We demonstrate the effectiveness of the SP selection phase by two parts, the first one details how SP selection works, and the second part explains the importance of this phase in the plant TM.

a) *Ranking SP by SS:* Fig. 9 gives an example of the SP selection process, where we are looking for 5 SP out of 9 candidates (nodes of t2 and t3 + one t9) to conduct a workflow  $\rightarrow$  composed by s1 and s2. We only visualize the  $DS$  of t9 since its  $SG$  are all null, and it is placed after the competition of CN.

As one can see, a node being outstanding at one service type may not be equally great at others, such as node 4 in Fig. 9(a). Furthermore, the ranking of  $SS$  also relies on the  $QSP$  of each node, e.g., node 7 with relatively poor  $OSG$  gets forth place in  $SS$  ranking due to its outstanding  $QSP$ . The performance analysis is discussed in the next part.

b) *The performance of SP selection:* We consider 3 scenarios: ranking the candidate SP by  $SS$ , only  $QSP$ , and random. We select 10 nodes (randomly, no t8) among CN to play WSP such that their service provision would be rated 0.25, and all other policies are unchanged, as stated in Section IV-B. In addition, we employ  $OSG$  to compare three scenarios to illustrates the real quality level in terms of service composition.

As shown in Fig.10, the  $OSG$  values of ranking by  $SS$  case remain stable and outperform the random one and only  $QSP$  one. The random one is unsteady, and its  $OSG$  values are evidently bad. Ranking by  $QSP$  case is more stable than the random

<sup>2</sup>Noise  $\pm 0.05$  counted for all ratings.

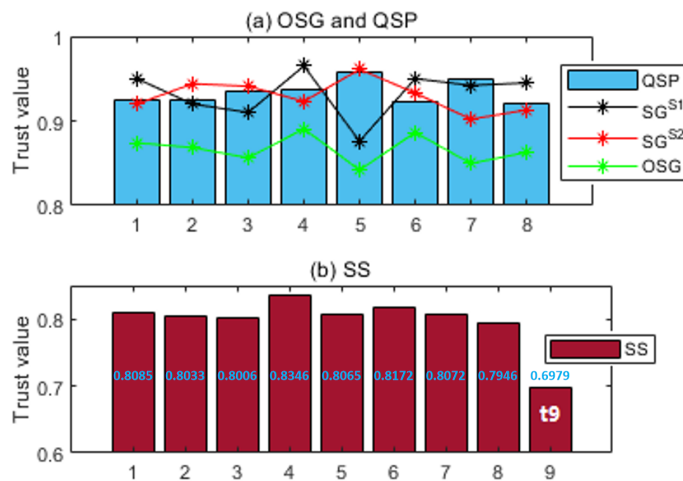

Fig. 9: A capture of selection score ( $SS$ ) computation based on candidate nodes' overall service grade ( $OSG$ ) and quality of service provider ( $QSP$ )

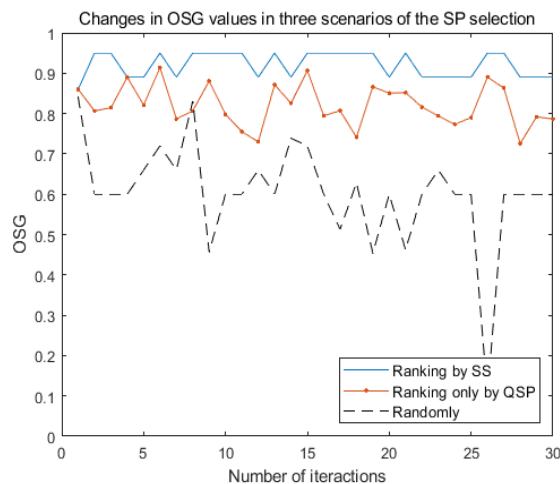

Fig. 10: Changes in overall service grade ( $OSG$ ) values in three scenarios of the SP selection

one, but it is still occasionally exceeded by random one, i.e., it does not extract the best SP. Moreover,  $OSG$  values in ranking by  $QSP$  case also have a decreasing trend since  $QSP$  is positively correlated with the feedback. Therefore, ranking by  $SS$  is optimal in SP selection, as it enables the selection of the best SP among candidates and prevents SBA by measuring the  $SG$  values.

3) *Resilience*: This section focuses on the resilience against attacks on services, namely NCA, OOA, CBA, SBA, BMA, BSA, and SPA. We observe the behaviors of the attacker by illustrating the changes in its trust value. In fact, the attacker will be treated with specific measures when some of their trust values are under 0.5 ( $TS$ ,  $QSR$ , and  $SG$ ). For this reason, we force the SP selection to choose the attacker to conduct/rate service in order to visualize their behavior and validate the effectiveness of the proposed model.

4) *OOA*: To demonstrate the behavior of the OOA attacker, we set a malicious node that provides services continuously by switching between good (0.95) and bad (0.45) over time. Fig. 11 shows that the OOA attacker behaves intelligently to keep its  $QSP$  above a certain threshold, e.g., 0.5. With the help of  $\theta$ , the manager can detect earlier the OOA attacker by measuring the stability of behavior in terms of time, and punishing the services without good feedback. Furthermore, it costs longer time for the attacker to recover its reputation. As discussed in Section III-A4c, service provider nodes can only gain reputation by keeping providing good services in a continuous way.

5) *CBA*: In the simulation performed to observe CBA, we consider the attacker misbehaves with 30% client nodes during its service provision. Table VII illustrates average feedback values from the attacked nodes and other nodes to evaluate the attacker.

In Fig. 12,  $QSP$  of 'with  $\lambda$ ' case decreases faster than the case without  $\lambda$  since  $\lambda$  enables the reduction of the  $QSP$  of nodes that behave differently with different nodes. The punishment degree of 'without' case is insufficient to segregate the

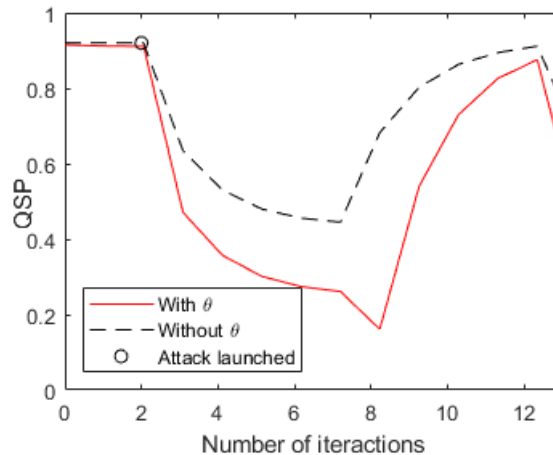

Fig. 11: Changes in quality of service provider ( $QSP$ ) with  $\theta$  and without  $\theta$  in presence of on-off attack (OOA).

TABLE VII: Feedback values for the attacker after the attack launched

Description	Value
Avg feedback from the attacked nodes	0.452
Avg feedback from others	0.9442

attacker from general nodes, even though the simulation lasts long enough, i.e., it is too difficult to detect a CBA attacker without  $\lambda$ .

6) *SBA*: In this scenario, we deploy one CN node of t3 as the SBA attacker, since it has three service types. We consider all three service types  $s1 \sim s3$  targets of SBA, i.e., in each service provision phase, the attacker picks one service type to misbehave (rated 0.45), and it does well for other types (rated 0.95). As we did before, we force the attacker to conduct service to observe its behaviors under the *SG* mechanism.

Fig. 13 illustrates the changes in *SG* values of three service types. As it can be seen, the attacker switches between services to alternatively behave well and badly, e.g., it recovers  $SG^{s1}$  and  $SG^{s2}$  when misbehaving in  $s3$ . Eventually, *SG* values all drop under 0.5. As defined in Section III-A4d, the service types whose *SG* goes under 0.5 will be regarded as nonfunctional, and the SP cannot provide such service anymore. Furthermore, we measure the selection score *SS* by looking at the *SG* and *QSP*, the attacker's *SG* values are poor because of conducting bad services, and this also decreases its *QSP* value. Therefore, it has less chance to be selected as a SP.

7) *BMA/BSA*: These attacks lead a good service provider to be snubbed and a bad service provider to be promoted. To handle with them, comparing individual feedback with average level can determine the honesty of service raters. We set a compromised node act as a SR that dishonestly rates the 30% of SP (rate 0.45/0.95 for good/bad services). As shown in Fig. 14(a), the attacked node's *QSP* recovers its trustworthiness since the attacker node has been detected and isolated because of  $TS < 0.5$ . Analogously, badly-performing nodes' *QSP* drops after the isolation of the attacker node, in Fig. 14(b). Indeed, BMA and BSA act in an opposite way about each other, but they both aim at disrupting the rating mechanism, so that the good SP does not get positive feedback and the malfunctioning/malicious ones earn reputation.

8) *SPA*: SPA mainly consists of two kinds [8, 9]: The first case indicates that an end-user possessing multiple nodes in the network, can promote these nodes by self-assigning good feedback; To have greater competitiveness in SP selection, the node may promote its importance by boosting several trust values in second case. The first case often occurs in SIIoT, since users can easily hold multiple endpoints, but it is constrained in IIoT, due to the plant controller as a centralized entity to conduct the local TM. Moreover, the service provider is disallowed to rate the service provided by itself in our model. To prevent the second one, it is necessary to exclude the metrics that are not relevant to service type and provider. For example, in our model, the way that the node can improve its importance in the SP selection is to be rated positively to increase its *SG* and *QSP*. To do so, it has to conduct outstanding services, and thus earning the reputation without giving satisfying services is impossible.

### C. Inter-plant TM

This section moves to the evaluation of the inter-plant TM. Table VIII illustrates the simulation configuration of the inter-plant TM, we set 5 plants with different service types and neighborhood situations. We consider that p1 and p4 are constrained so that they would ask other plants to give a hand by sending nodes providing functional services. Moreover, we set p2 that performs uncooperatively to p1.

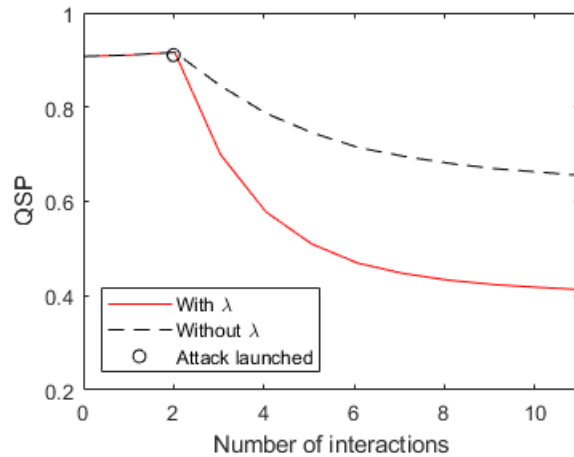

Fig. 12: Changes in quality of service provider ( $QSP$ ) with  $\lambda$  and without  $\lambda$  in presence of conflicting behavior attack (CBA).

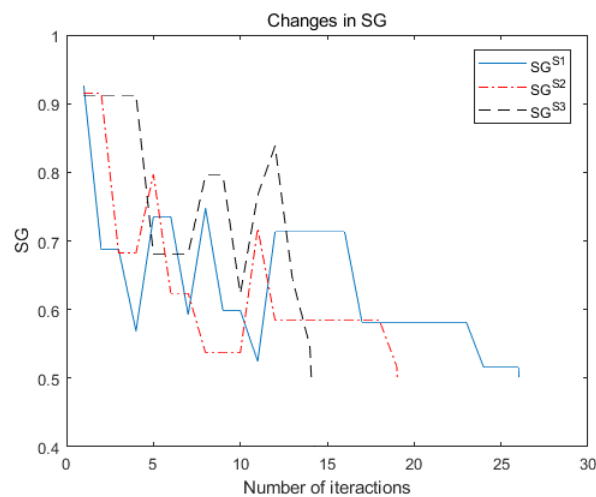

Fig. 13: Changes in service grade ( $SG$ ) values by service types in presence of selective behavior attack (SBA).

Fig. 15 gives the simulation results with related trust values, namely  $IS$ ,  $CO$ , and  $CS$ . Sub-figures in each line represent the subjective opinions from the evaluator plant, e.g., the first line corresponds to the trust values calculated by the p1 to assess other plants. There are some no-interaction cases, such as p1-p4 and p1-p5, as shown in sub-figures 14, 15, 41, and 51, where the  $CO$  values remain unchanged, i.e., no nodes moving to a new plant between them. p1 differs from p4 and p5 in terms of services as defined in the simulation configuration, and thus they do not interact at all even although p1 is constrained. Particularly in sub-figures 53 and 35, p3 and p5 have common services but they keep silent to each other, this is because they are both unconstrained.

Since we set p2 to perform in an uncooperative manner with p1, as can be seen in sub-figure 12, the  $CO$  and  $CS$  values go down, and notably, these values increase at the same time in sub-figure 13. p2 sends nodes providing functional services to help p1 address p1's constrained status, as illustrated at the beginning of sub-figure 12. However, p1 suffers from the malfunctioning or malicious nodes from p2, and it switches the source of nodes when it detects that p2 is uncooperative, i.e.,  $CS_{12} < 0.5$ . p3 does not interact with p1 at the beginning due to the poor  $IS_{13}$  value, such that p1 does not count p3 as helpful. After that p2 is classified into the distant plant (DP) category, p1 asks p3 for help as they have common services. Similarly, p3 and p5 meet the need of p4, and thus their communication frequency remains significant.

## V. CONCLUSION

In this report, we have presented a phase-based trust management framework for service-oriented IIoT, which considers two trust levels: plant and inter-plant. The plant TM designed four phases: access control, service provider selection, service evaluation, and node classification, to address the security issue in IIoT from the service perspective, and more importantly, the countermeasures against attacks on services, namely NCA, OOA, CBA, SBA, BMA, BSA, SPA. The inter-plant TM assesses the trustworthiness between plants by dynamically observing their relationship in terms of cooperativeness. Through intensive simulations, we have verified that the proposed TM model is adequate and accurate for dealing with trust issues in IIoT. For



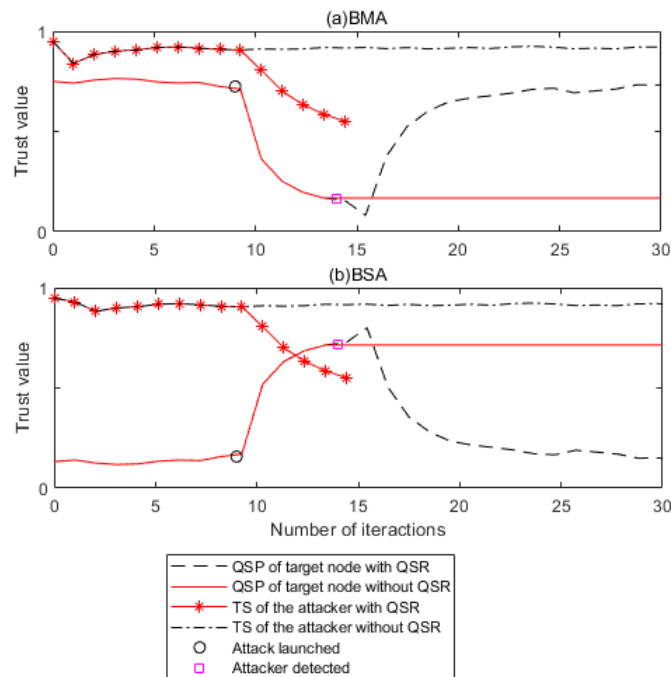

Fig. 14: Changes in trust values of both attacked and attacker nodes with quality of service rate ( $QSR$ ) evaluation and without this evaluation in presence of (a) bad mouthing attack (BMA) and (b) ballot stuffing attack (BSA).

TABLE VIII: Configuration of 5-plant simulation

Conf.	Description				
Plant	p1	p2	p3	p4	p5
Service types	1~20	6~25	15~35	26~35	30~40
Neighbor	p2	p1,p3,p4	p2,p4,p5	p2,p3,p5	p3,p4
Constrained	Y	N	N	Y	N
Uncooperative	N	To p1	N	N	N

putting forward this TM model into industrial plants, as future work, we plan to implement our proposed TM model functions within real-world SOA-based IIoT devices including service providers, service raters, and trust manager on the controllers.

#### REFERENCES

- [1] Runbo Su et al. "PDTM: Phase-based dynamic trust management for Internet of things". In: *2021 International Conference on Computer Communications and Networks (ICCCN)*. IEEE, 2021, pp. 1–7.
- [2] Golam Kayas et al. "SUPnP: Secure Access and Service Registration for UPnP-Enabled Internet of Things". In: *IEEE Internet of Things Journal* (2021).
- [3] Kwok-Yan Lam and Chi-Hung Chi. "Identity in the Internet-of-Things (IoT): New challenges and opportunities". In: *International Conference on Information and Communications Security*. Springer, 2016, pp. 18–26.
- [4] Stavros Salonikias et al. "Access control in the industrial internet of things". In: *Security and privacy trends in the industrial internet of things*. Springer, 2019, pp. 95–114.
- [5] Luigi Atzori et al. "The social internet of things (siot)—when social networks meet the internet of things: Concept, architecture and network characterization". In: *Computer networks* 56.16 (2012), pp. 3594–3608.
- [6] Charith Perera et al. "Context aware computing for the internet of things: A survey". In: *IEEE communications surveys & tutorials* 16.1 (2013), pp. 414–454.
- [7] Asrin Vakili and Nima Jafari Navimipour. "Comprehensive and systematic review of the service composition mechanisms in the cloud environments". In: *Journal of Network and Computer Applications* 81 (2017), pp. 24–36.
- [8] Ray Chen, Fenyao Bao, and Jia Guo. "Trust-based service management for social internet of things systems". In: *IEEE transactions on dependable and secure computing* 13.6 (2015), pp. 684–696.
- [9] Wafa Abdelghani. "A multi-dimensional trust-model for dynamic, scalable and resources-efficient trust-management in social internet of things". Theses. Université Paul Sabatier - Toulouse III ; Université de Sfax (Tunisie), Dec. 2020. URL: <https://tel.archives-ouvertes.fr/tel-03215718>.

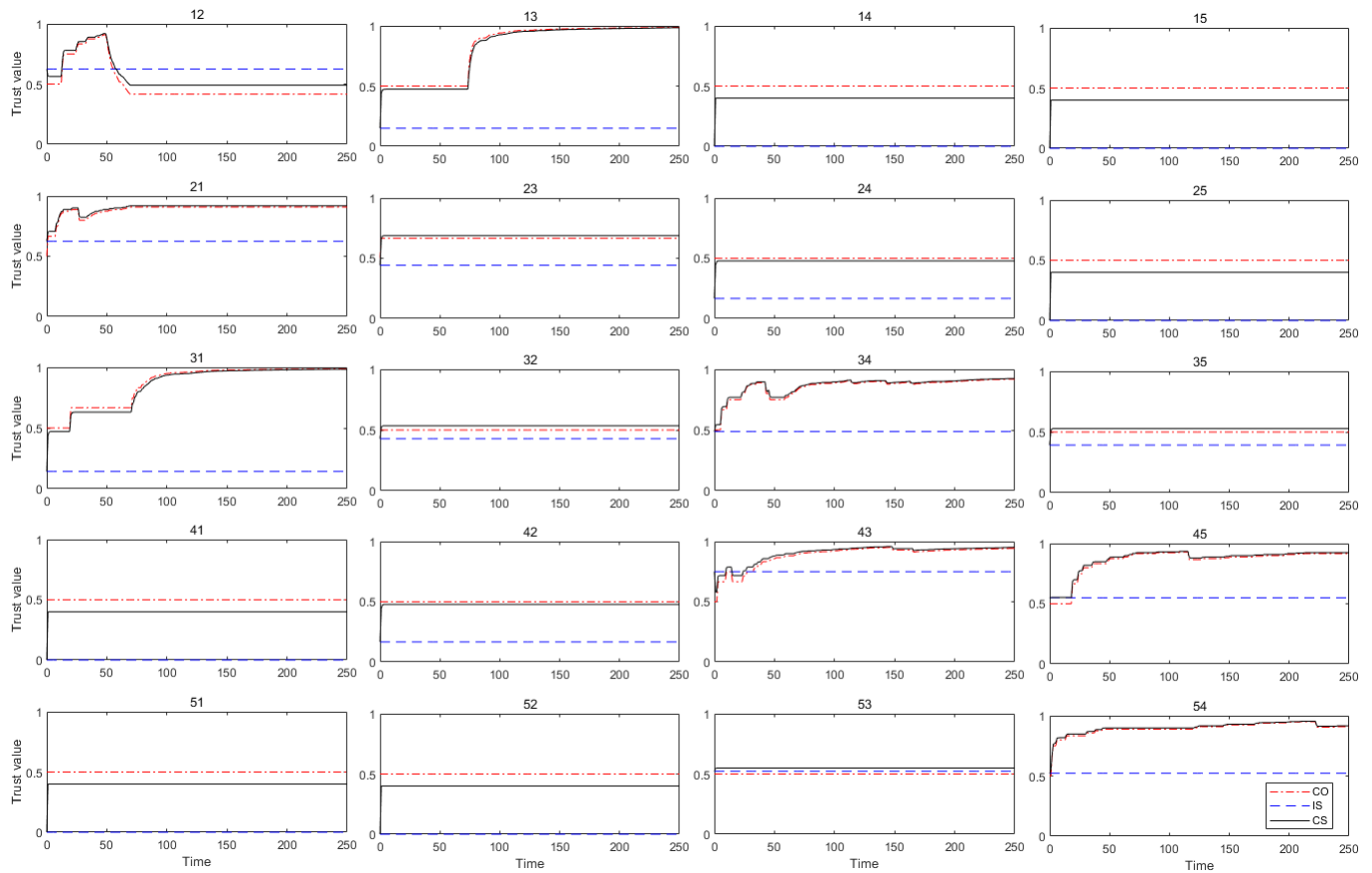

Fig. 15: Changes in initial score ( $IS$ ), cooperativeness ( $CO$ ), and cooperation score ( $CS$ ) values in 5-plant scenario