



HAL
open science

FIVE DECADES OF SOLAR RESEARCH AT THE PIC DU MIDI TURRET-DOME (1960 -2010). PART 1: OVERVIEW OF INSTRUMENTATION AND OBSERVATIONS

Th Roudier, J.-M Malherbe, J.-P Rozelot, P Mein, R Muller

► **To cite this version:**

Th Roudier, J.-M Malherbe, J.-P Rozelot, P Mein, R Muller. FIVE DECADES OF SOLAR RESEARCH AT THE PIC DU MIDI TURRET-DOME (1960 -2010). PART 1: OVERVIEW OF INSTRUMENTATION AND OBSERVATIONS. *Journal of Astronomical History and Heritage*, 2021, pp.585-606. hal-03359767

HAL Id: hal-03359767

<https://hal.science/hal-03359767>

Submitted on 5 Oct 2021

HAL is a multi-disciplinary open access archive for the deposit and dissemination of scientific research documents, whether they are published or not. The documents may come from teaching and research institutions in France or abroad, or from public or private research centers.

L'archive ouverte pluridisciplinaire **HAL**, est destinée au dépôt et à la diffusion de documents scientifiques de niveau recherche, publiés ou non, émanant des établissements d'enseignement et de recherche français ou étrangers, des laboratoires publics ou privés.

FIVE DECADES OF SOLAR RESEARCH AT THE PIC DU MIDI TURRET-DOME (1960–2010). PART 1: OVERVIEW OF INSTRUMENTATION AND OBSERVATIONS

Th. Roudier

Observatoire Midi Pyrénées (OMP), IRAP, Toulouse, France.

E-mail: Thierry.Roudier@irap.omp.eu

J.-M. Malherbe

Observatoire de Paris (OP), PSL Research University, LESIA, Meudon, France.

E-mail: Jean-Marie.Malherbe@obspm.fr

J.-P. Rozelot

Université de la Côte d'Azur, Observatoire de la Côte d'Azur (OCA), Grasse, France.

E-mail: Jean-Pierre.Rozelot@univ-cotedazur.fr

P. Mein

Observatoire de Paris (OP), PSL Research University, LESIA, Meudon, France.

E-mail: Pierre.Mein@club-internet.fr

and

R. Muller

Observatoire Midi Pyrénées (OMP), IRAP, Tarbes, France.

E-mail: Richard.Muller@irap.omp.eu

Abstract: The Pic du Midi Turret-Dome, known as 'Lunette Jean Rösch' or LJR ('lunette' for refractor in French), was scientifically active during five decades between 1960 and 2010. It was dedicated to high spatial resolution observations in solar astronomy. We review fifty years of advances in solar instrumentation and solar physics made by this instrument in various domains, which took advantage of the good seeing at Pic du Midi. First, we summarize some of the LJR results in broad-band and wide-field imagery of the photosphere; as this topic was the initial goal and has been the most important contribution of the refractor, details will be provided in Part 2. Then, we present spectro-polarimetric instrumentation and observations with narrow slit and imaging spectroscopy of the photosphere and the chromosphere. The Turret-Dome also housed an original spectro-coronagraph, and observations of the high temperature coronal plasma are highlighted. Finally, we describe progress in the determination of the solar shape with the heliometer. The LJR remained active until the launch of the Hinode and Solar Dynamics Observatory satellites (in 2006 and 2010, respectively).

Keywords: Pic du Midi Observatory, Turret-Dome, imagery, spectroscopy, polarimetry, solar physics, photosphere, chromosphere, corona

1 INTRODUCTION

The Sun is the only star whose proximity allows us to study the details of its atmosphere (photosphere, chromosphere and corona at respectively 6000 K, 8000 K and 2 MK); indirectly, oscillations of the surface can be used to probe its interior. Although day-time turbulence is generally much more severe than during night time, it has been possible to obtain at Pic du Midi (2870 m elevation) high resolution observations of the Sun. In 1954, Jean Rösch (Figure 1) and his team began to observe with a 0.23-m refractor and obtained many photographs of granulation. Indeed, the Sun is covered by several millions of granules which correspond to small convective cells (1000 km each, 1 km/s typical velocity, mean lifetime of

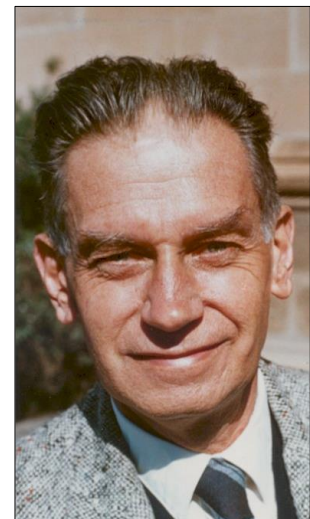

Figure 1: Jean Rösch (1915–1999) was the Director of Pic du Midi Observatory from 1947 to 1981. Among many other activities he promoted the development of high resolution solar physics and initiated the construction of the Turret-Dome (courtesy: OMP).

10 minutes). Their observation requires a resolving power of 0.5" or better. Results were so promising that it was decided to build an optimized instrument, the Turret-Dome.

2 HISTORY OF THE PIC DU MIDI TURRET-DOME

As early as 1943, under the leadership of famous astronomer Bernard Lyot (1897–1952), the technical study of a telescope, especially optimized for high resolution observations, was undertaken. The main idea was to reduce as best as possible the turbulence in and around the dome. It was suggested to close the tube of the telescope with a front glass and to limit air exchange through the dome aperture, which produces turbulent flows on the path of the light beam. This goal was extremely difficult to achieve. For night astronomy, which requires large diameter telescopes, it became possible only after 1980. But for solar observations, the project was easier, because smaller light collectors are convenient. A reduced model of a closed dome, prolonged by a tube, was built and its aerodynamical properties were tested and studied in a wind tunnel. Streamlines were visualized around the model in several positions and elevations of the tube (Figure 2). The results were satisfying, so that the construction of the dome started in 1954. It was built by the workshop of Bagnères de Bigorre, under the direction of Jacques Pageault. The project consisted in a dome of 5.0-m diameter (which is rather tiny for a 6.50-focal length refractor) in order to minimize the localised turbulence. The size of the dome required to manage an aperture for the refractor, in order to reject the objective at several meters away from the turbulent zone. The rectangular aperture of the dome was closed by two metallic and rolling curtains moving with the refractor, for which a circular hole was managed. The tube was protected by a helmet, also moving with the telescope, and equilibrated by two counterweights located inside the dome (Figure 3). The difficulty of this new concept was to imagine a coupling mechanism allowing the helmet and the dome (in azimuthal rotation) to catch the Sun and follow automatically the refractor. At that time, it was a real challenge to transmit the right ascension (α) and declination (δ) motions of the refractor to the dome without any vibration, only by the means of electro-mechanical contactors. The equatorial table and fork were manufactured by Arsenal de Tarbes. It is an extremely rigid and heavy construction based on a 2.4-m diameter disk which rotates around the polar axis. This big wheel is mounted on two roller carriers and motors; it supports a large metallic fork which holds the refractor

(Figure 3). This system was to be copied later for the 1.0-m night telescope at Pic du Midi.

Figure 4 shows the different steps of the construction. Comparable architectures (closed dome, circular aperture) were chosen later for the 2.0-m night telescope at Pic du Midi (1980) and the 1.0-m THEMIS evacuated solar telescope located in Tenerife (2000). Figure 5 shows the Turret-Dome nowadays; scientific observations were stopped in 2010, but the instrument is still used for teaching purpose.

3 IMAGERY OF THE PHOTOSPHERE

Imagery is the main contribution of the LJR to solar physics with more than 40 research papers; as discoveries are numerous, they will be presented in Part 2, so here we just mention striking results. The first observations were performed with the 0.38-m refractor of Toulouse Observatory. A flexible washer around the objective, which was rejected several meters outside the dome, prevented air exchange to preserve image quality. The 0.38 m lens was built by brothers Henri, from Paris Observatory. The instrument was used for the first time during the eclipse of 15 February 1961 (98% magnitude). Excellent observations of the solar photosphere were obtained. The photographs (35 mm films) were systematically taken in motion picture mode (bursts of 50 images at 16 or 24 frames/s) that revealed new and unexpected features in the evolution of the solar granules. In order to reduce the turbulence around the focus, J. Rösch invented an ingenious cooling system to evacuate the heat brought by the light beam. This system consists of imaging the Sun on a double-walled glass cylinder, inside which circulates water and glycol (10 litres/minute).

The principle of high cadence observations was based since 1961 on a selection *a posteriori* of the best images of the photosphere. The first cinematographic camera used by J. Rösch was a Gaumont hand-cranked camera lent by one of his friends in 1962. This program continued for many decades, with continuously improved results. But the 0.38-m objective, which was initially designed for stellar observations, had a field of view too small for the study of large areas on the Sun. For that reason, J. Rösch got funds to order a new 0.50-m refractor (two flint and crown lenses). In 1972, the old 0.38-m objective was totally replaced by the new one, polished by Jean Texereau. Hence, the Turret-Dome became the best imager available worldwide to study the Sun's surface, and remained unique until the construction of the Dunn Telescope at Sacramento Peak (USA, 1970), and much later, the Swedish Solar Telescope (Canary Islands, 1990, up-

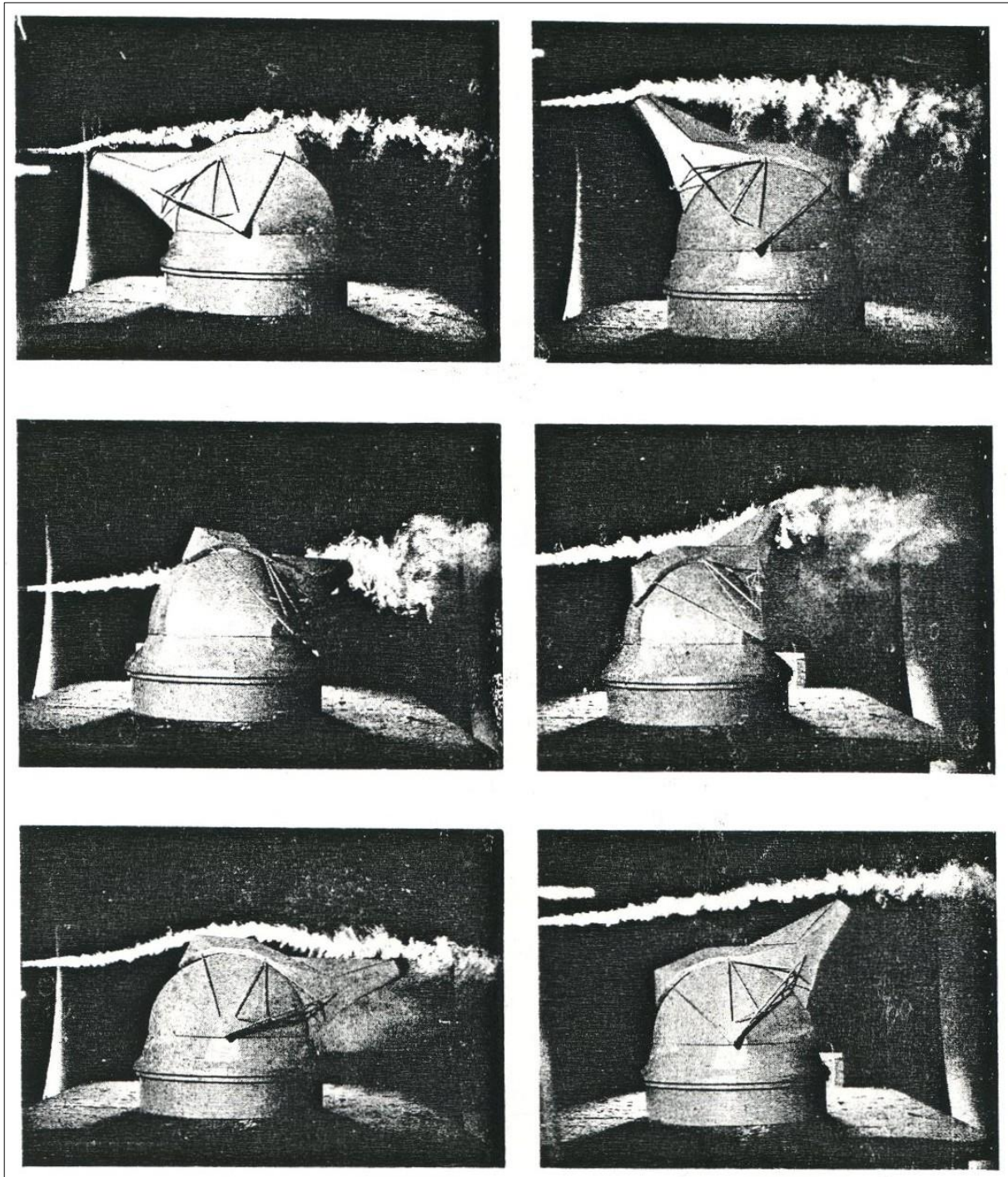

Figure 2: A reduced model of the dome and helmet was tested in a wind tunnel to study the occurrence of turbulent flows under various conditions (courtesy: OMP).

graded 2002) and finally the launch of the Hinode satellite (2006).

Fine structures down to 0.25'' (180 km on the Sun surface, [Figures 6 and 7](#)) could be observed regularly, when the seeing was good, approaching the theoretical resolution of the refractor. Sunspots ([Muller, 1981](#)) were studied. The variability of the photospheric network was investigated from June 1975 to May 1979 with Call K broad-band filters ([Muller, 1983](#), and

[Figure 6](#)) and with G-band filters since June 1980 ([Muller and Roudier, 1984](#), and [Figure 7](#)), revealing fluctuations of bright points as the signature of concentrated magnetic fields. The analysis of the granulation and meso-granulation (groups of granules, 8'' typical size) demonstrated the high quality of the instrument ([Roudier et al., 1998](#)). The exploding granule phenomenon was evidenced. It leads to the formation of trees of fragmenting granules ([Roudier](#)

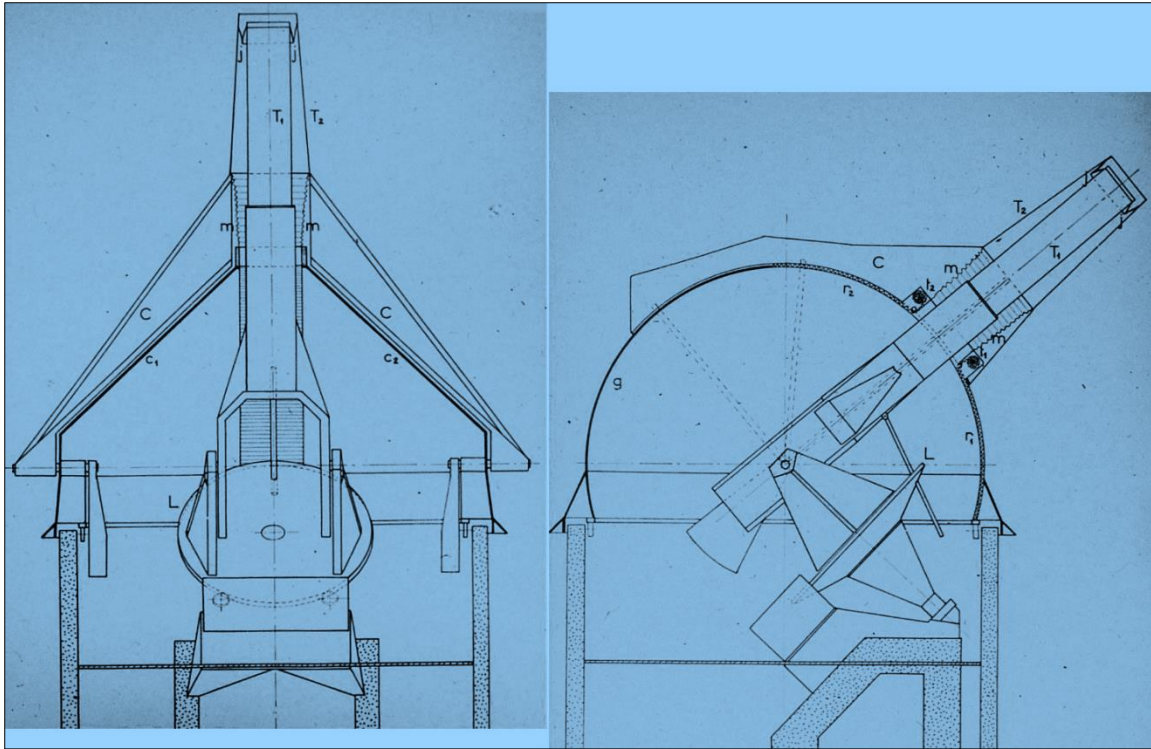

Figure 3: Drawings of the Turret-Dome (1960). C, C_1 , C_2 , T_2 = helmet structure; g = dome; T_1 = refractor tube; j, m = flexible washers; r_1 , r_2 = rolling curtains; L = equatorial table and fork (courtesy: OMP).

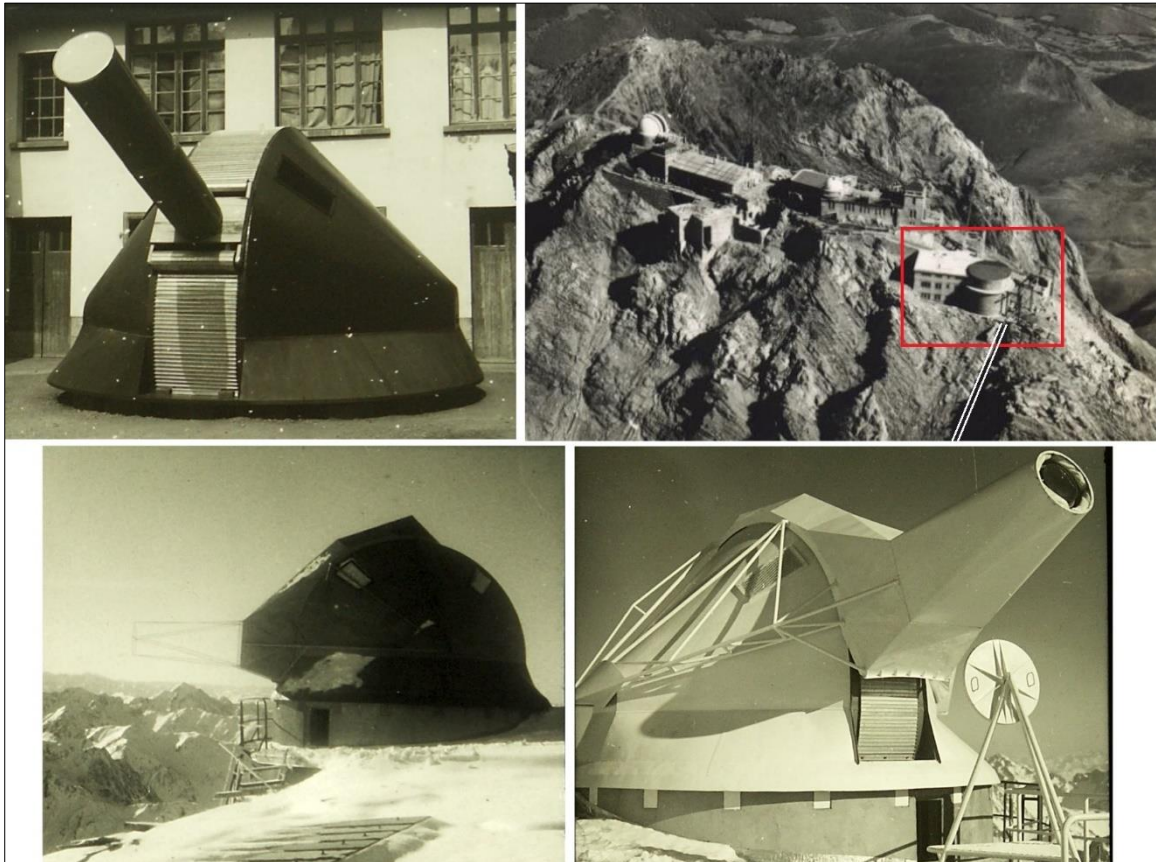

Figure 4: The steps of the construction of the Pic du Midi Turret-Dome. Top: the dome and tube of the refractor in Bagnères de Bigorre between 1954 and 1960; the metallic curtains closing the aperture are visible (left). Much before, in 1947, a 10 m diameter tower was erected at the East crest of Pic du Midi (red box at right) to support a new dome; for that purpose, a funicular (white rails) was installed to transport material during the summer season. Bottom: the dome and helmet during the assembly (left) and the final aspect in 1961 (right) (courtesy: OMP).

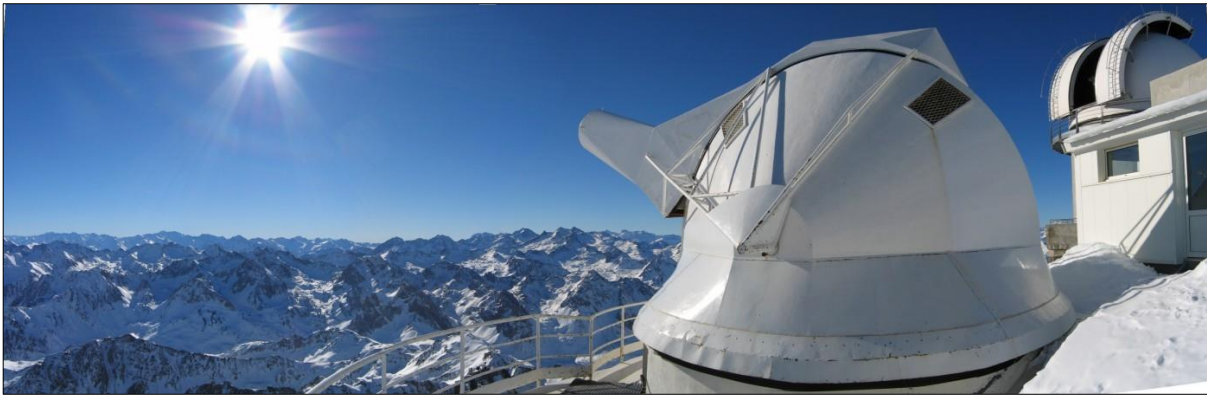

Figure 5: The Pic du Midi Turret-Dome in 2010 (courtesy: S. Rondi).

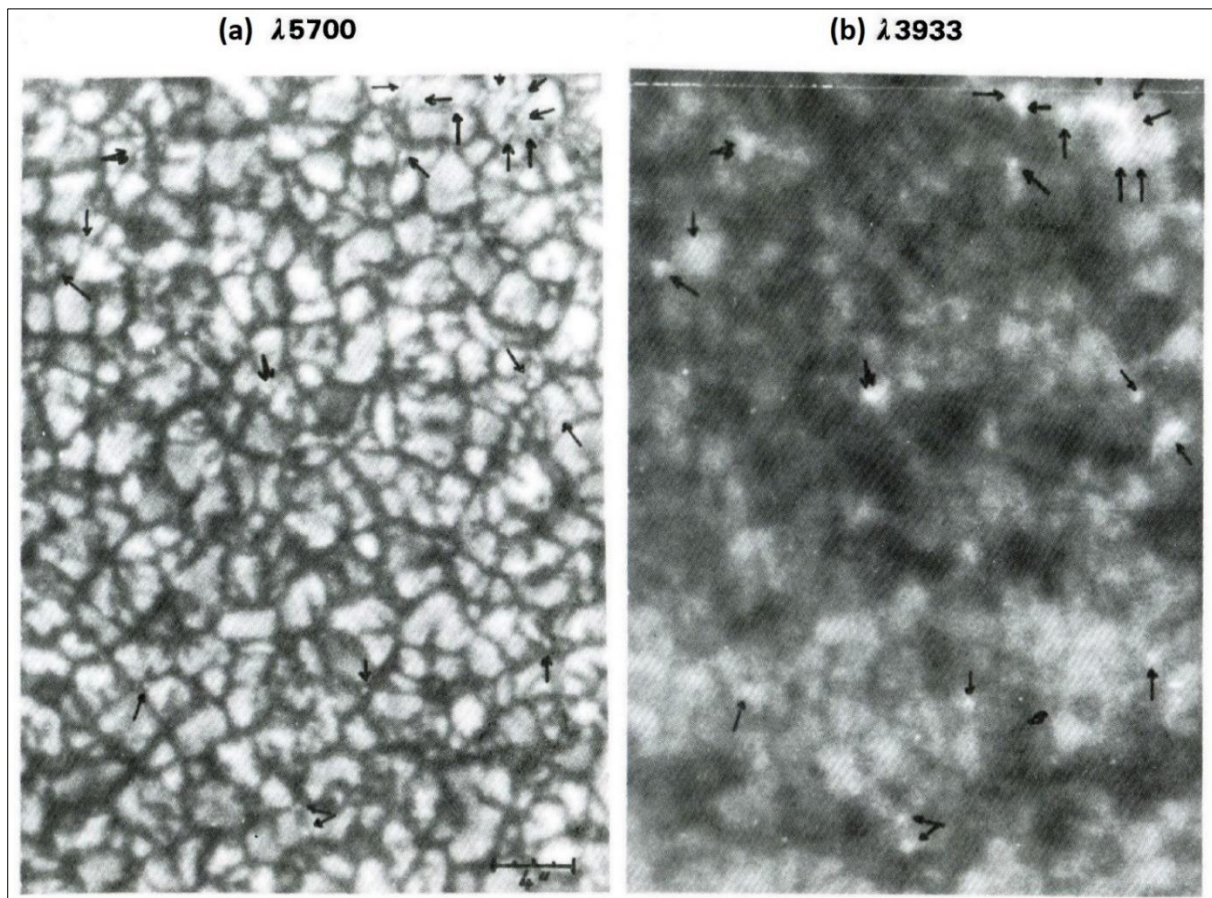

Figure 6: Typical images of the solar granulation obtained at the Pic du Midi Turret-Dome with broad-band filters at 5700 Å, 60 Å FWHM (a), and Cal K 3934 Å, 15 Å FWHM (b). Network bright points are indicated by arrows. The mean size of granules is 1000 km. FOV 30" × 40" (after Muller, 1983: 115).

and Muller, 2004), which compose families corresponding to the meso-granular scale. Horizontal flows were derived from local correlation tracking and could explain the formation of super-granules covering the chromosphere (30" typical size). Power spectra of surface flows were obtained by Rieutord et al. (2010). Espagnet (1994) investigated the relationship between the granulation pattern and the 5-minute oscillations.

A tunable monochromatic filter (the FPSS)

was developed at Meudon Observatory by Audouin Dollfus (1924–2010). It was a complex assembly of two Lyot-type filters and a polarimeter (0.13 Å FWHM at 5800 Å, Figure 8), described by Dollfus et al. (1985), which moved in 1992 to the Turret-Dome. The velocity and magnetic fields of fine structures, in spectral lines such as Fe I 5576 Å (for velocities), Fe I 6173 Å or Na D1 5896 Å (for magnetic fields), were studied in collaboration with R. Muller and Jacques Moity.

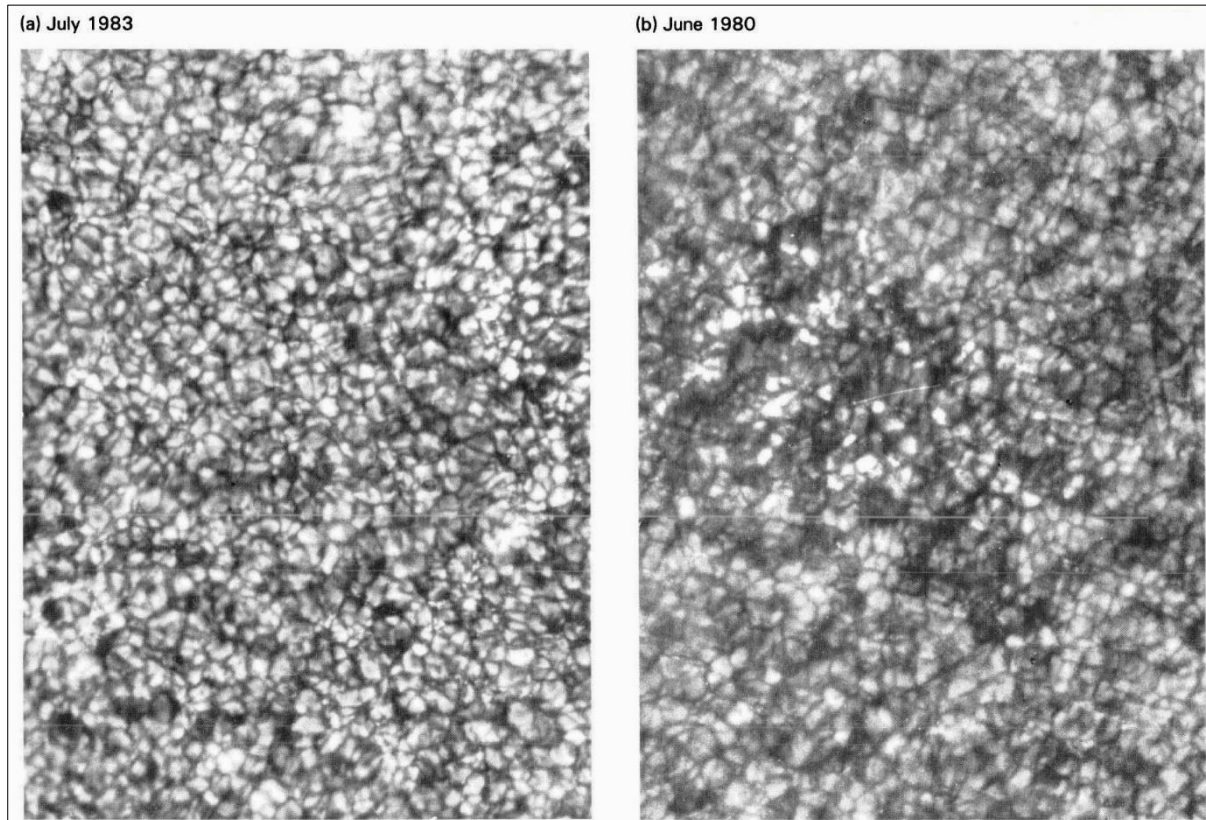

Figure 7: Variation of the photospheric network observed at the Pic du Midi Turret-Dome with a G-band filter (waveband of the CH molecule at 4308 Å, 10 Å FWHM) near solar minimum (a) and solar maximum (b). Bright points (magnetic elements) appear in intergranular lanes. FOV 90" × 120" (after Muller and Roudier, 1984: 36).

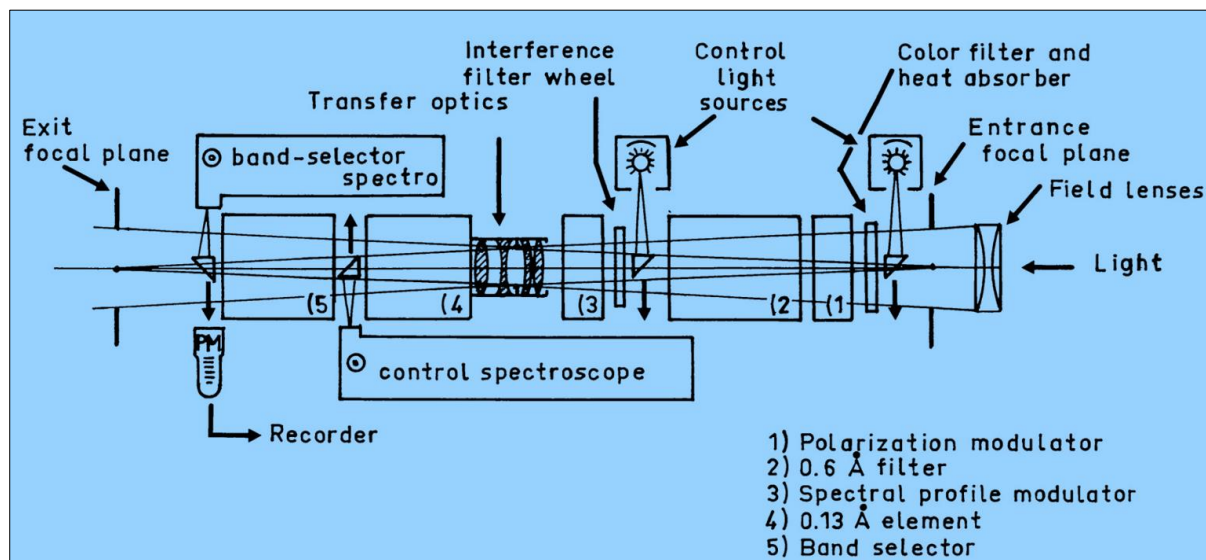

Figure 8: The 'Filtre Polarisant Solaire Selectif' (FPSS) developed at Meudon and installed on the Turret-Dome in 1992 was composed of two Lyot filters and a polarization modulator (after Dollfus et al., 1985: 242).

The high spatial resolution observations of the photosphere continued until the launch (2006) of the Solar Optical Telescope (SOT) onboard Hinode (JAXA/NASA/ESA) which carries a telescope of the same diameter (0.5 m) without any seeing effect, providing until 2016 (camera breakdown) much longer (12–24 hours) and fully homogeneous sequences.

CALAS (Camera for Large Scale Solar surface) was the last imagery project. It started in 2002 with Sylvain Rondi, Nadège Meunier, Michel Rieutord and one of us (T. Roudier). It was the first 4k × 4k CMOS camera dedicated to high frame rate and wide field observations of the Sun's surface (Rondi, 2006, and Figure 9). However, this project met a lot of technical

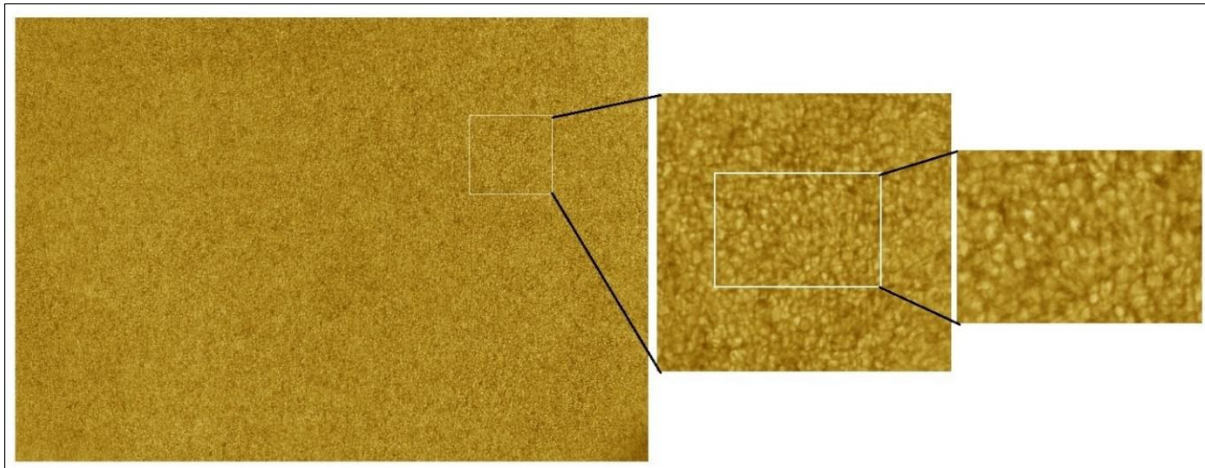

Figure 9: The wide wide field ($10' \times 10'$) of the CALAS camera for photospheric observations (after Rondi, 2006: 102).

problems and was abandoned when Solar Dynamics Observatory (SDO) was launched in 2010 by NASA. Indeed, SDO provides images of the full Sun from space at 45 s cadence with $4k \times 4k$ CCDs, although the spatial resolution ($1''$) is smaller than the one expected from CALAS.

4 SPECTROSCOPY AND IMAGING SPECTROSCOPY OF THE PHOTOSPHERE AND THE CHROMOSPHERE

In the frame of the French program of the International Geophysical Year (IGY 1957), Raymond Michard (1925–2015), with the help of his colleagues, Roger Servajean (1913–1986) and Georges Laborde (1916–1984), decided to build, at Pic du Midi, a new laboratory devoted to solar spectroscopy (see Mein and Mein, 2020, for details).

A horizontal telescope (0.50-m diameter at $f/22$) was fixed and fed by a coelostat (two flat mirrors reflecting the solar light in a constant direction, the primary mirror compensating the Earth's rotation). A 4.0-m flare spectrograph (dispersion $3 \text{ mm}/\text{\AA}$) was installed in the laboratory; it gave a lot of spectra in the range $3550\text{--}8800 \text{ \AA}$ at the maximum of solar cycle 19. Later, a second telescope was introduced together with the larger 9.0-m spectrograph (dispersion $6.5 \text{ mm}/\text{\AA}$). But, in the seventies, the image quality produced by these instruments became insufficient, in comparison with other places around the world. Hence, it was decided to move the spectroscopic observations from the West to the East crest of the Observatory, at the Turret-Dome. However, there was no spectroscopic equipment. In 1975 Zadig Mouradian (Figure 10) proposed to attach a 8.0-m focal length (folded) spectrograph, the Spectro-Turret, above the refractor (Figure 11). As a

counterpart, the spectrograph was moving with the telescope, which affected the stability of the spectra a little.

4.1 The Spectro-Turret

The Spectro-Turret built by Mouradian et al. (1980) is an 8.0-m focal length Littrow-type spectrograph described in Figure 12; the beam was folded two times inside, by two flat mirrors (numbers 11, 12) to reduce the box size to fit with the available space above the refractor (3.0 m). The concave mirror (13) is the collimator. The grating (14) is 316 grooves/mm ruled, $63^\circ 26'$ blaze angle, providing a dispersion of about $5.4 \text{ mm}/\text{\AA}$. The spectra were initially formed on 35 mm or 70 mm films, before the introduction of a CCD in the early 2000s. The orders of spectra were selected by interference filters (100 \AA Full Width at Half Maximum, FWHM). The grating rotated to observe the spectral lines in the range $3800\text{--}8800 \text{ \AA}$.

The primary focus of the refractor was at $f/13$. The solar image (60 mm diameter) was magnified 5 times by a lens (4) to form a sec-



Figure 10: Zadig Mouradian (1930–2020) was the principal investigator of the Spectro-Turret (courtesy: OP).

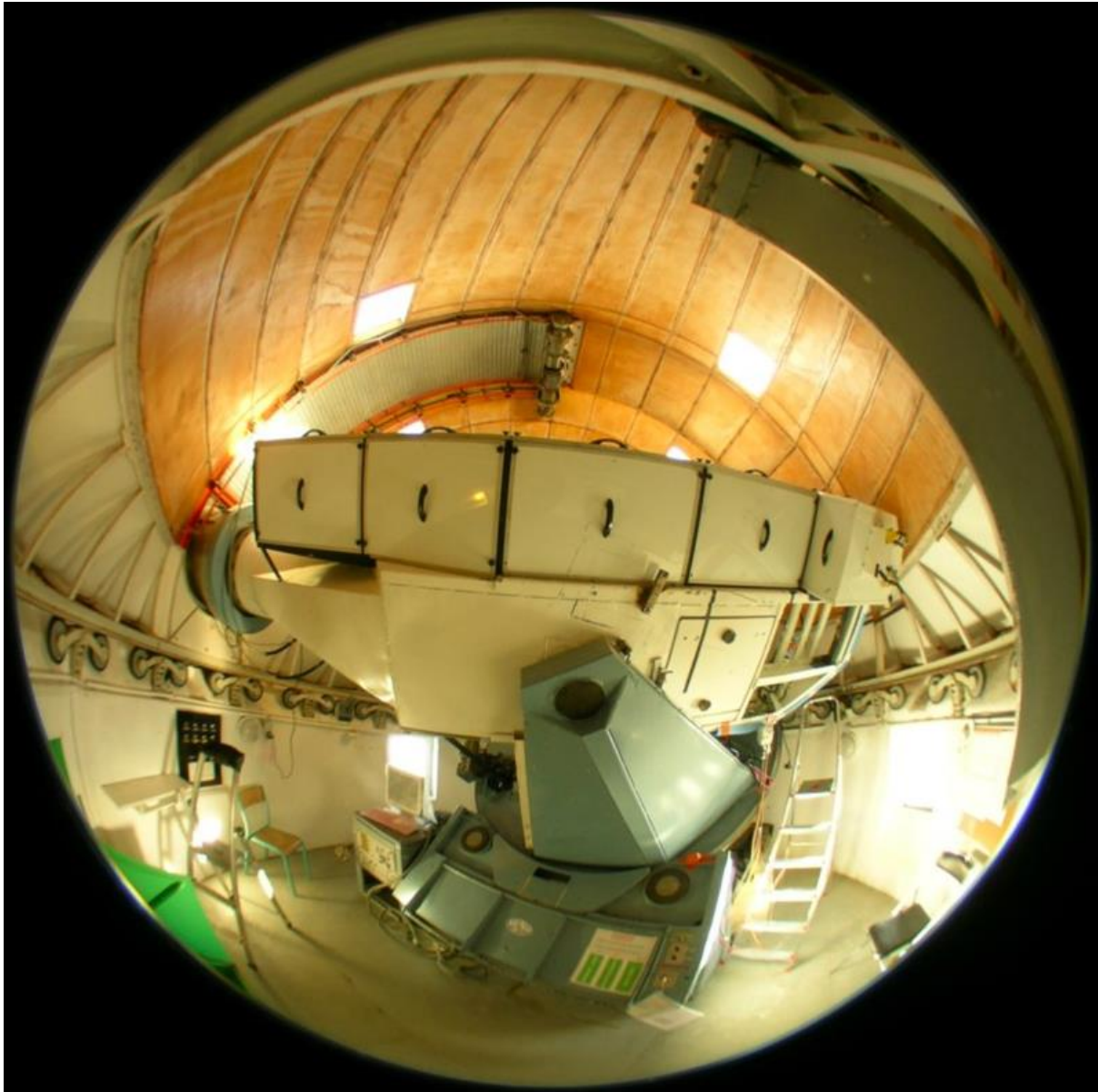

Figure 11: A fish eye view of the 0.5-m / 6.5-m refractor and the 8.0-m focal length spectrograph above (courtesy: S. Rondi).

ondary focus at $f/65$ (300 mm solar diameter) in the focal plane of the spectrograph, where various slits (7) and filters (8) were available. A slit jaw, using 35 mm films and broad band filters, allowed recording of the slit position in the field of view. As the movement of the refractor was not perfect, a guiding system was installed. It was composed of a tip-tilt plate (2) coupled to a white light guiding telescope. Four cells detected the limb and maintained the field centred on the solar target.

The Spectro-Turret was excellent; it produced high quality spectra of fine structures such as spicules at the limb (Figure 13), which are thin jets of plasma ejected from the supergranular network at 20 km/s. The spectrograph also incorporated an imaging spectroscopy mode to study the dynamics of photospheric

and chromospheric structures at a fast rate.

4.2 Imaging Spectroscopy: The Multi-channel Subtractive Double Pass (MSDP)

The MSDP is an imaging spectroscopy technique that has been upgraded many times over the last decades on several telescopes (Mein et al., 2021). The principle was first described by Mein (1977). It is a double pass spectrograph (as usual, the first pass on the grating is dispersive, but the second one is subtractive to form many spectra-images). It uses a 2D rectangular entrance window, which replaces the narrow slit (7) in Figure 12, and a slicer is located in the spectrum (Figure 14), just after the first pass on the grating. The slicer selects N channels (beam-splitter) and realigns the N

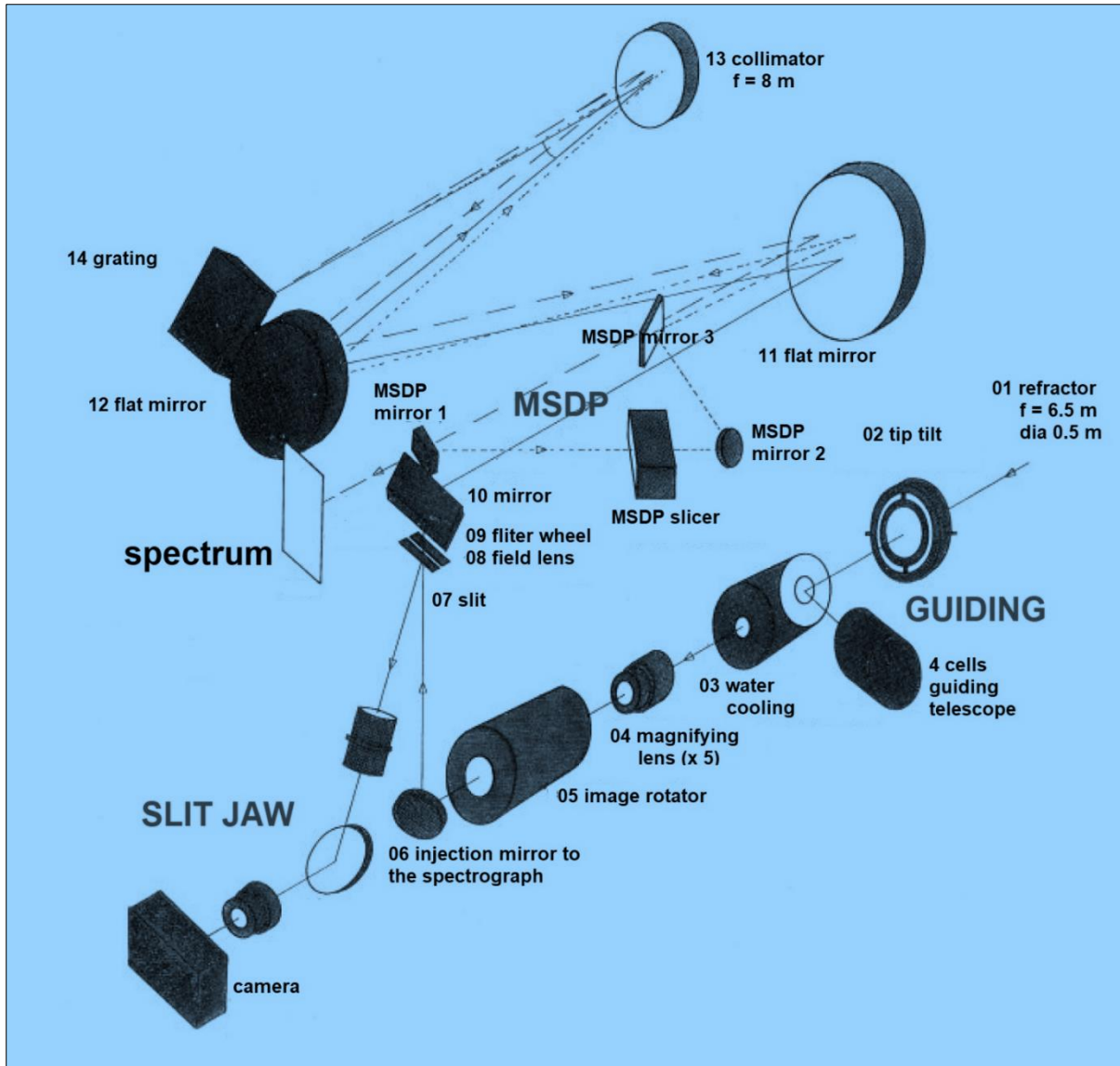

Figure 12: The optical path from the refractor (not drawn) to the spectrum. Two additional optical devices exist around the light path: the guiding telescope and the slit jaw. The MSDP imaging spectroscopy device (slicer plus three folding mirrors) is incorporated in the core of the spectrograph (after Mouradian et al., 1980: 274).

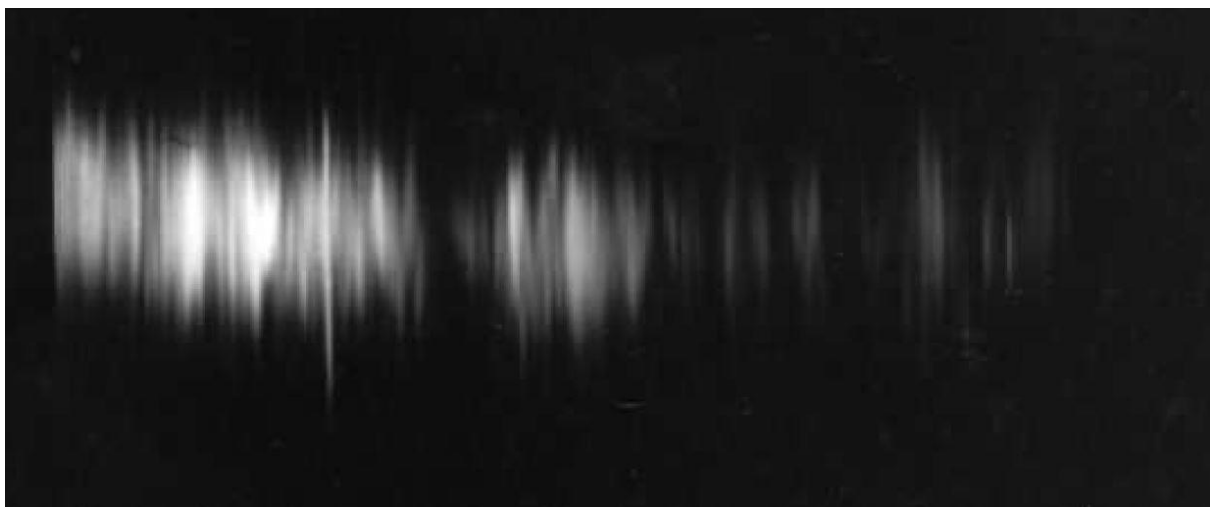

Figure 13: Spectra of spicules (chromospheric plasma jets) at the limb in H α obtained with a curved slit by Z. Mouradian, revealing the Doppler effect. The wavelength is in the y-direction (courtesy: OP).

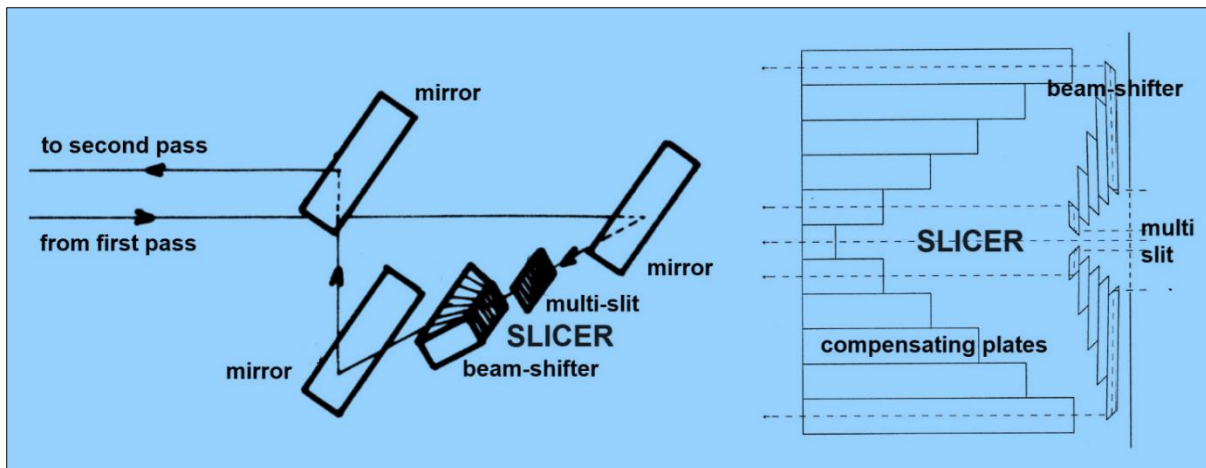

Figure 14: The MSDP device. Left: the slicer in the spectrum is composed of two parts, the beam-splitter (multi-slit) and the beam-shifter which realigns the beams for the subtractive pass on the grating. Right: details of the slicer (the beam-shifter is made of prisms and compensating plates) (after [Mein, 1980: 289](#)).

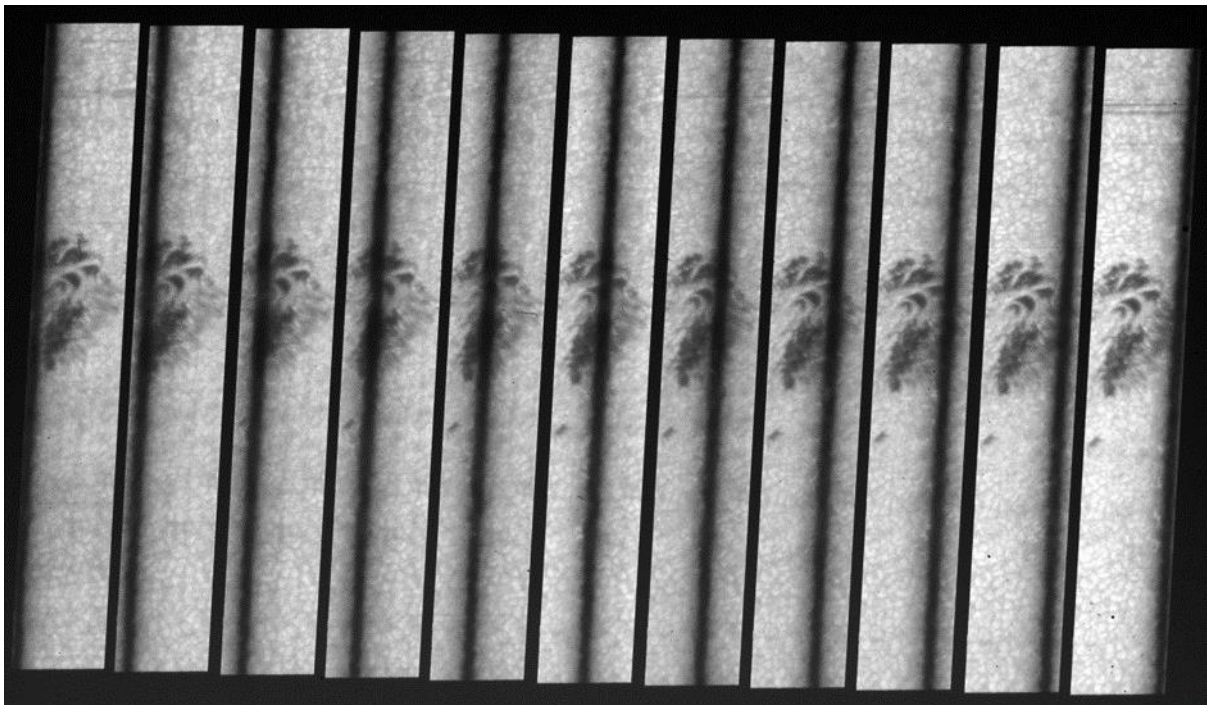

Figure 15: High resolution MSDP spectra-image in Na D1 5896 Å line with 11 simultaneous channels. There is a constant wavelength step between each channel; the wavelength varies linearly from the left to the right side of each channel (after [Malherbe et al., 2004: 748](#)).

channels (beam-shifter) before the subtraction of the dispersion by the second pass. The output of the MSDP is composed of N contiguous spectra-images ($N = 11$ in [Figure 15](#)). There is a constant wavelength step between each spectra-image, but inside each, the wavelength varies linearly along the x -direction. Datacubes (x, y, λ) are extracted from a single exposure. Hence, the MSDP combines the advantages of filters and classical spectroscopy. The frame rate is just limited by the photon flux and the detector speed. At Pic du Midi, two slicers were included ([Mein, 1980](#)), mainly for broad lines such as $H\alpha$ and Na D1, with respective spectral

resolutions of 0.26 and 0.13 Å. The Na D1 line ([Figure 15](#)) provided outstanding observations of the dynamics of the granulation ([Malherbe et al., 2004; Roudier et al., 2003; 2006](#)). The $H\alpha$ line was more intensively used in the frame of international campaigns with space telescopes such as the Solar Maximum Mission (SMM) in the eighties, the YOHKOH/SXT (JAXA), the EIT imager and the SUMER/CDS spectrometers onboard SOHO (Solar and Heliospheric Observatory, ESA/NASA) in the nineties. About 35 research papers were produced. This success inspired P. Mein to incorporate later a more powerful MSDP on the German Vacuum Tower

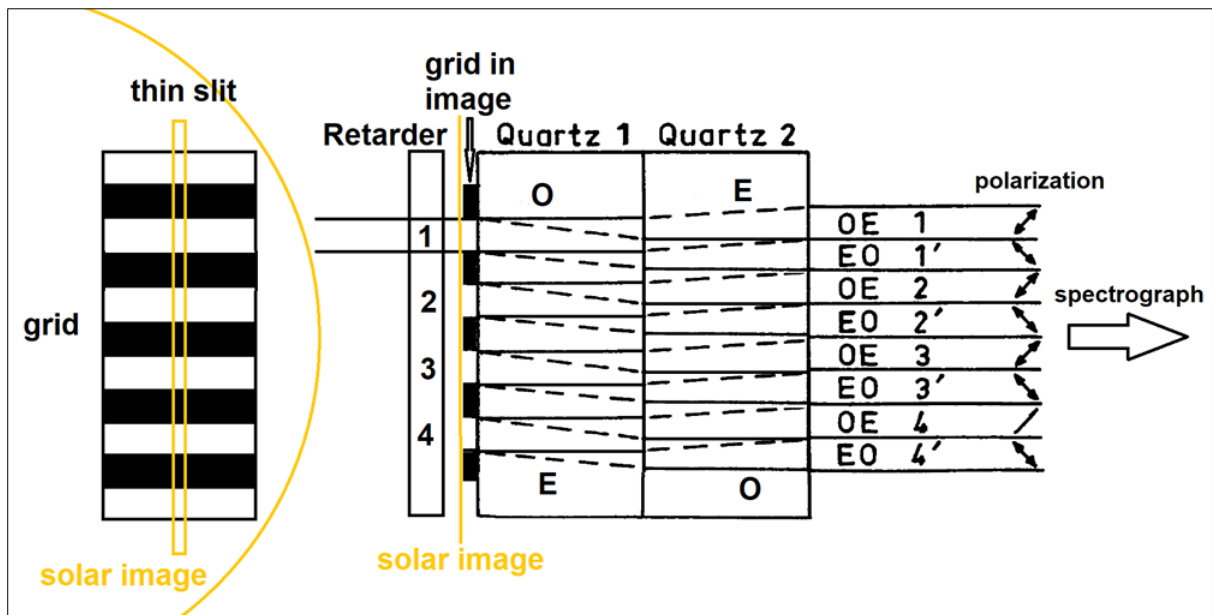

Figure 16: The polarimeter built by M. Semel (1932–2012) is located at the primary focus of the refractor before magnification and injection into the spectrograph. O = ordinary ray; E = extraordinary ray. The grid and the narrow slit are in the solar image at $f/13$ (after [Semel, 1980: 370](#)).

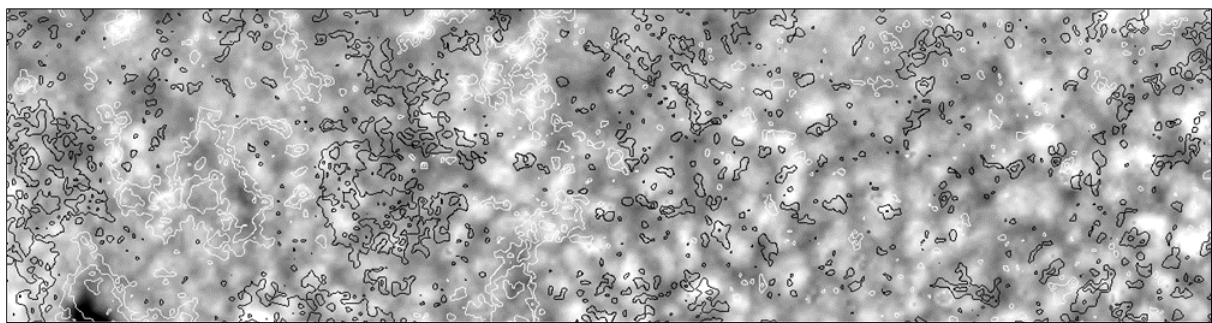

Figure 17: High resolution magnetic fields (black/white isocontours for North/South polarities) in the solar granulation obtained with the MSDP in polarimetric mode (Na D1 5896 Å line) (after [Malherbe et al., 2004: 752](#)).

Telescope (VTT) and the THEMIS telescope in Tenerife, but neither of them overtook the spatial resolution of the MSDP at Pic du Midi.

5 POLARIMETRIC MEASUREMENTS

Polarimetry was introduced by Z. Mouradian and Meir Semel in 1980 with a grid-based device, composed of two quartz analysers, together with achromatic quarter and half wave plates, mounted in a rotating wheel ([Semel, 1980](#); and [Figure 16](#)). This polarimeter was able to deliver $I \pm Q$, $I \pm U$, $I \pm V$ in sequence with three successive exposures, where I , Q , U and V are the Stokes parameters. As a single exposure provided two linear combinations (such as $I \pm V$) with optical path compensation (two quartz plates), this was a high precision polarimeter (10^{-4} or less) dedicated to faint polarizations (such as the ones met in the linearly polarized spectrum of the limb, also called ‘second solar spectrum’). This device was not designed for large fields of view, because of the presence of the grid masking

half of the field.

For this reason, an alternative method was implemented by [Malherbe et al. \(2004; 2007a; 2007b\)](#) using Liquid Crystal Variable Retarders (LCVR). This technique allowed fast measurements of magnetic fields in the solar granulation through the Zeeman effect, with the MSDP at high spatial resolution. In order to select the best spectra-images, high speed (5 Hz) bursts, providing $I+V$ and $I-V$ alternatively, were obtained. Best data of each sequence were aligned and destretched, providing the impressive result shown in [Figure 17](#). Both methods, developed and tested successfully at Pic du Midi, were exported and systematically exploited after 2000 on the THEMIS telescope in the Canary Islands, where Semel’s method provided measurements comparable in precision to the Zürich Imaging Polarimeter (ZIMPOL), the worldwide reference at that epoch.



Figure 18: The 0.15-m coronagraph with its spectrograph at the back, mounted in the fork of the Pic du Midi Turret-Dome (1966), after removal of the 0.38-m refractor (courtesy: OCA).

6 CORONAL SPECTROSCOPY OF THE HIGHLY IONIZED LINES

The coronal plasma is heated by multiple micro-eruptions to temperatures between one and three million degrees. The chemical elements, as iron, are then strongly ionized. The spectrum of such a plasma is characterized by emission lines superimposed to the continuum. Full observational sequences of ionized iron from UV to IR are particularly interesting for probing the coronal medium in terms of electron density and temperature.

The Turret-Dome housed a small coronagraph, 0.15-m diameter at $f/10$, feeding a spectrograph, which was commissioned in 1964 (Figure 18). It was first tested by André Carlier before opting for solar granulation observations. The coronagraph was taken over by one of us (J.P. Rozelot), who made it a systematic use from October 1965 to November 1969, and sporadically until December 1972, when the instrument was dismantled. Until then, it was necessary to remove the refractor to get the light beam on the coronagraph lens. But when the 0.38-m objective was replaced in 1972 by the 0.50-m, the coronagraphic program had to stop, because it was no longer possible to switch it.

J.P. Rozelot focused the scientific program

on the spectroscopy of iron lines, accumulating a wide set of data as quickly as possible. Indeed, the progress of filters opened new opportunities for the ground-based photography of monochromatic emissions (Leroy and Rösch, 1970) and the birth of space-borne instruments, first on rockets and then on satellites, should render the 0.15-m coronagraph obsolete. It was designed by J. Rösch and Marcel Hugon (Figure 19) for its optical part, and was manufactured at the Bagnères de Bigorre workshop under the direction of J. Pageault. The spectrograph was a Czerny-Turner (two spherical mirrors and grating, 17° blaze angle, dispersion of $0.067 \text{ mm}/\text{Å}$). An ingenious system allowed us to explore the corona and record successive spectra around the limb, as shown by Figure 20. This original instrument was extremely efficient and able to take full advantage of the site quality for observations of the highly ionized lines (FeX to FeXV). The UV FeXIII 3388 Å line was easily observable, whereas it had been photographed only twice outside eclipses. The IR FeXI 7892 Å line was also visible, and its observational and theoretical study was done by Noëns and Rozelot (1974), and Rozelot and Noëns (1975). A total of seven emission lines was observed quasi-routinely with the help of the coronagraph and more than 17 research papers were published (e.g. Rozelot, 1970;

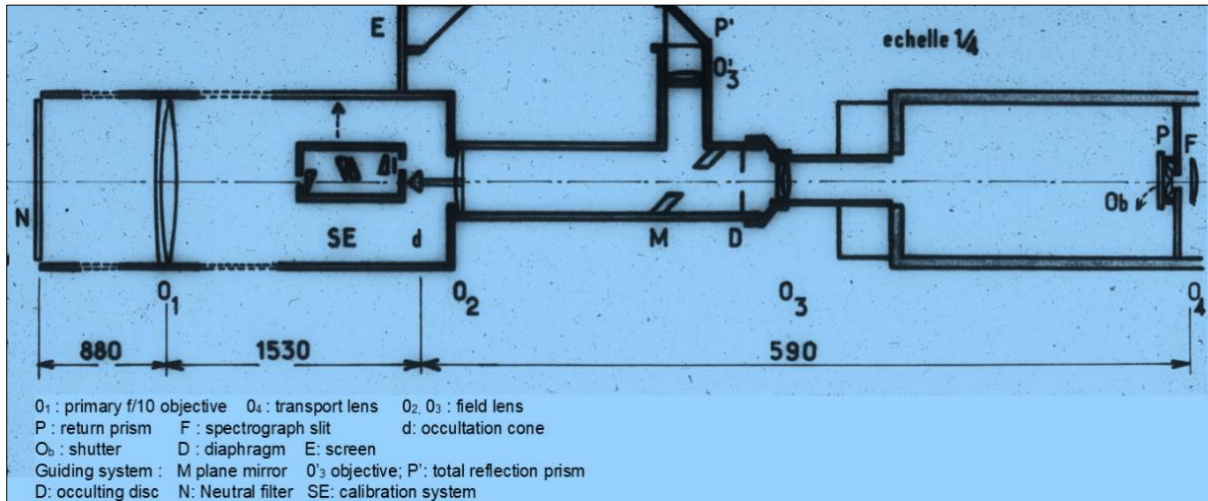

Figure 19: The 0.15 m coronagraph at F/10 designed by J. Rösch in 1964 (the spectrograph is not drawn, the entrance slit F is indicated at right) (courtesy: OCA).

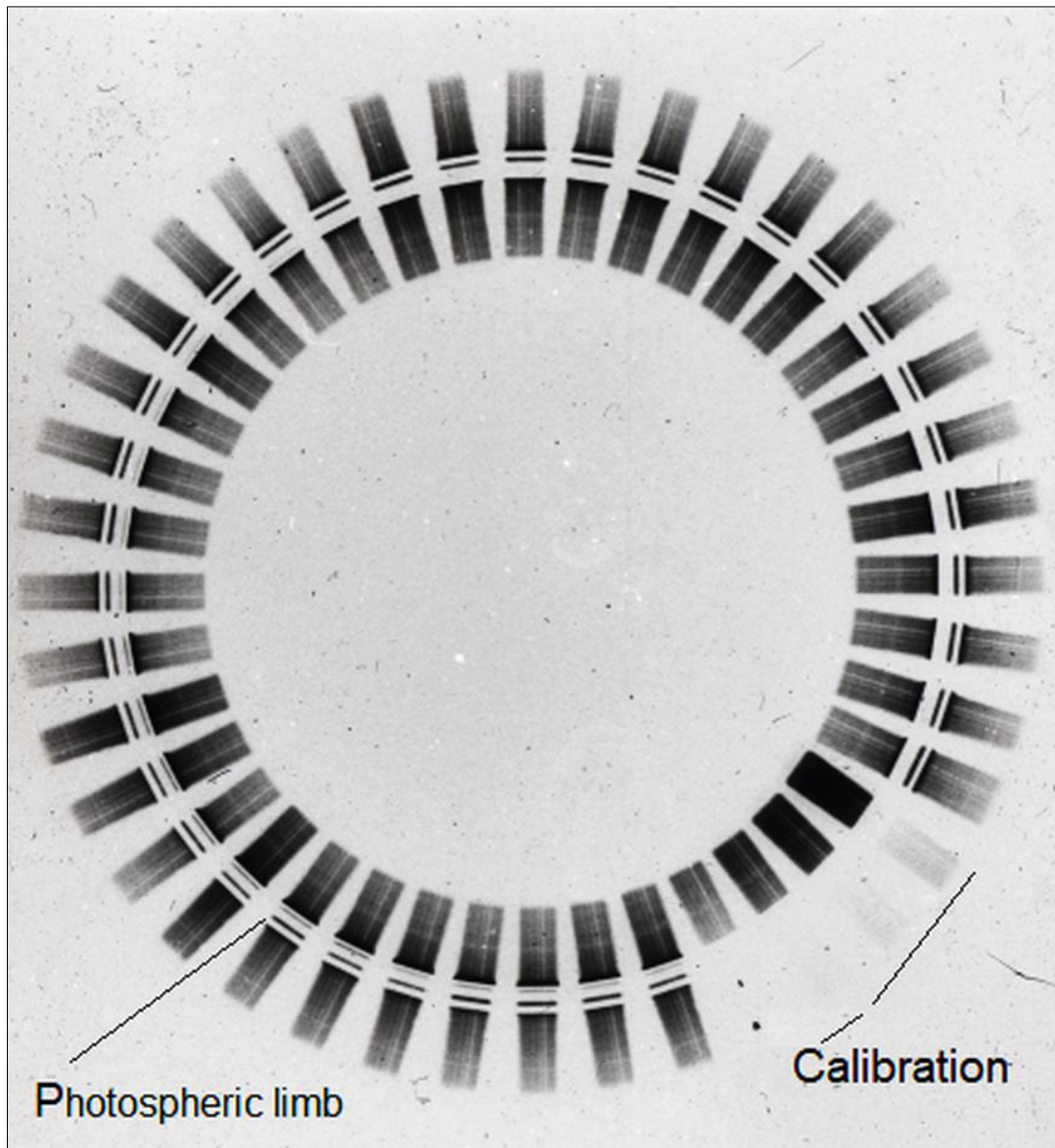

Figure 20: The spectro-coronagraph provided simultaneously the spectra of opposite limbs and was able to explore the corona around the Sun. Plages of calibration were made with successive exposures (courtesy: OCA).

1972). The analysis allowed to better understand the structure of the hot atmosphere, because from the measured intensity of an emission line it is possible to derive electron densities in the corona (Figure 21).

At this epoch, digital detectors did not exist. The electronic camera of André Lallemand (1904–1978) had an advantage over photographic plates, notably by the absence of threshold in the characteristics of the emulsions. As the almost complete darkness could be made in the Turret-Dome, the Lallemand camera was adapted on 8 and 11 May 1972 to the coronagraph for a specific purpose, the study of coronal activity in the polar regions (Rozelot and Despia, 1972). Despite good results, the ex-

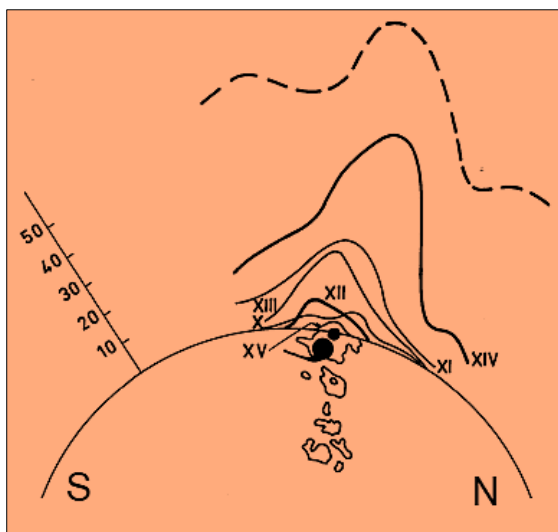

Figure 21: Polar diagram of the emission corona at 60'' from the solar limb, Eastern hemisphere, 19 May 1969, for the six states of ionization of FeX to FeXV. The dashed line represents the intensity of the white corona in arbitrary units. The scale (from 0 to 50) is in millionths of the intensity of a 1 Å band of the solar continuum. The appearance of sunspots has been reproduced from the maps of the Fraunhofer Institute (after Rozelot, 1970: 25).

periment was discontinued because of its complexity and the installation of the new 0.50-m refractor.

At last, the UV FeXII line, identified at 3010 Å by Migeotte and Rosen in 1954, deserves a special mention. This line was observed, under conditions of exceptional sky purity, on 19 May 1969 at 11:00 UT, at 85° of position angle (Rozelot, 1970). However, the wavelength was found at 3027.95 ± 0.08 Å and the analysis of FeXII energy levels showed an incompatibility with the 3010 Å wavelength, raising suspicion of an identification problem (Rozelot, 1969). This issue was resolved later by Del Zanna and De Luca (2018): it was FeX instead.

7 THE SOLAR SHAPE AND THE HELIOMETER

For J. Rösch, the heliometer was from 1968 until his retirement in 1981, one of his main interests, and from that date until his death in 1999, his almost unique research activity. We must go back to the context of 1967. Dicke and Goldenberg (Princeton, USA) had just published a paper in the *Physical Review Letters* on solar flattening. Evry Schatzman (pers. comm., April 1968), a well-known astrophysicist, told J. Rösch: "If Dicke is able to measure a solar flattening nearly at the sea level, one could be able to do so with greater precision at Pic du Midi." So J. Rösch imagined a sophisticated device to determine the diameters of the Sun for all heliographic latitudes, to be installed inside the Turret-Dome and take advantage of the sky quality.

The first operating mode was turned to the analysis of the intensity gradients of solar limbs, and so, the instrument was called 'limbmetre'. The scans were recorded between 30 November 1979 and 15 July 1981 and studied by Rösch and Yerle (1981). They deliberately adopted the definition of the solar diameter as the distance between the inflection points of opposite limbs, as being the most directly observable parameter. To achieve this measurement, the focal image of the Sun given by the refractor (60 mm) was projected onto a Zerodur rod cut with sharp edges, somewhat shorter than a solar diameter. The beams from the opposite limbs were transported by two rhombohedra to project both limbs (after a magnification) onto the same slit and detector (a photomultiplier). In front of the slit, a mirror cube, rotating over about 15°, alternatively clockwise and counter-clockwise, produced successive scans of the limbs (as in Figure 22). Between the limbs, a reference scan was sampled from the centre of the solar disk by the same detector, providing the darkening at any point of the limb. Forty-four scans per second could be produced, at the high speed of 3200"/s, in order to eliminate most atmospheric effects. The analysis was made through oscilloscope tracings showing the signal and its first derivative, from which intrinsic parameters (such as the shift of the inflection points or image blurring) were derived. These fast scans permitted Yerle (1981) to detect from the residuals two main oscillations, the first one of about 160 minutes period and the other one of about 5 minutes. At that time they could be attributed to terrestrial or solar effects, but they are now known to be of solar origin, demonstrating the good quality of the data.

Rösch improved the instrument, which took the name of 'heliometer' (Figure 23), because

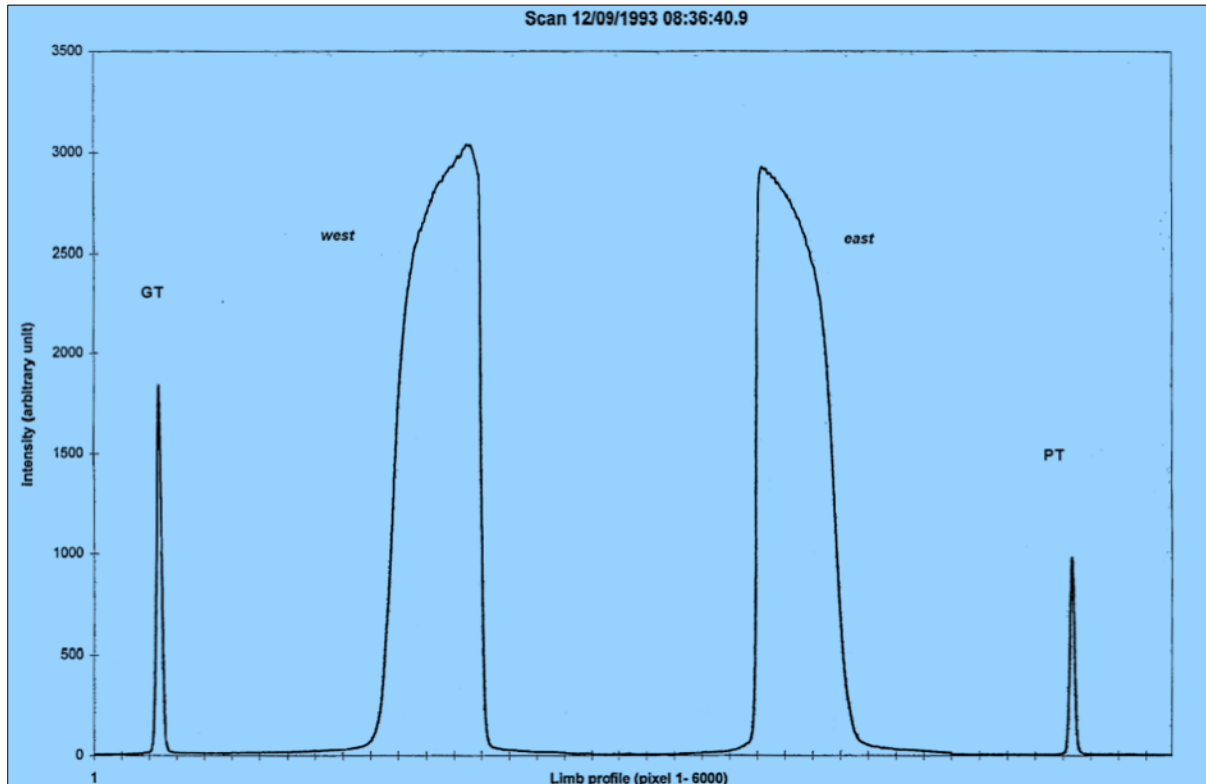

Figure 22: One of the first historical scan, obtained in 1993, showing both solar limbs acquired by the heliometer. The central occulted part was constant and accurately measured to be 1665.1" (courtesy: OCA).

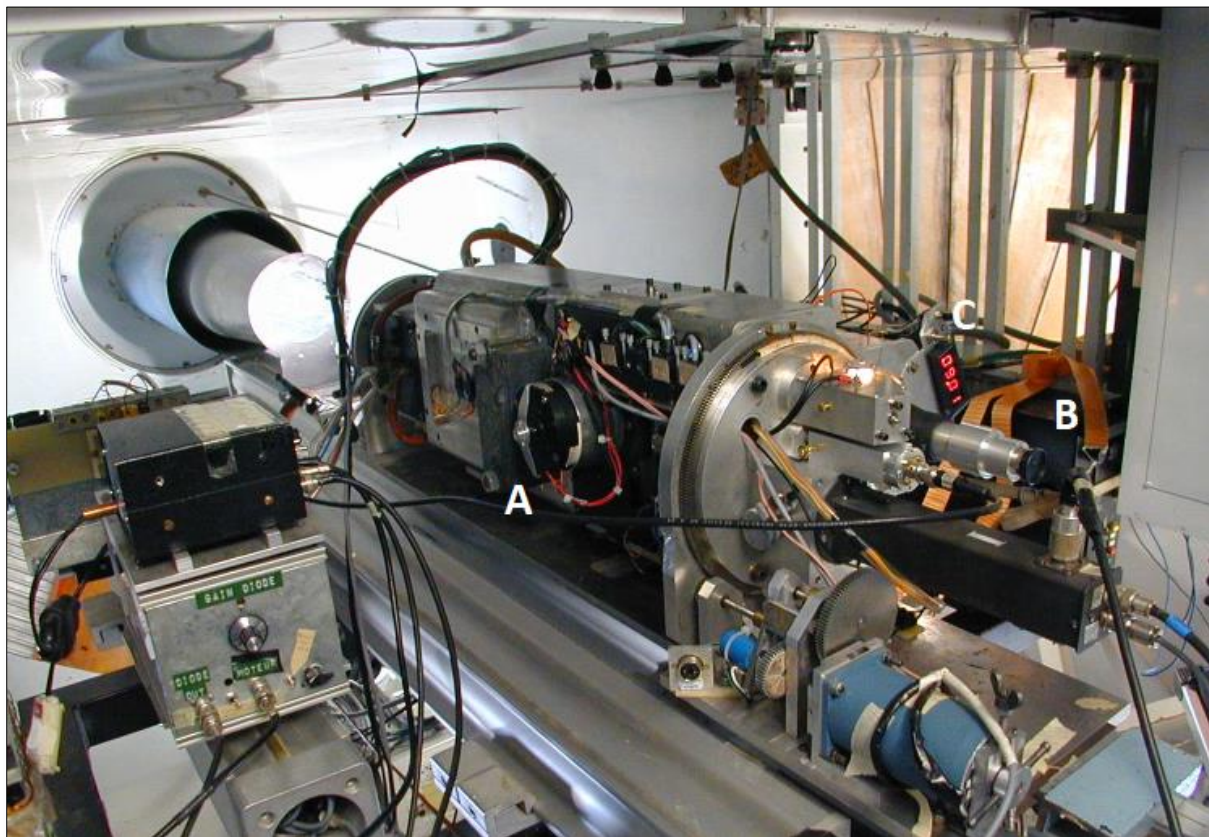

Figure 23: The heliometer mounted in the Turret-Dome. A: servomotor for scanning the light beam (producing the solar limb profiles). B: the output signal recorded through a photomultiplier. C: the digital image slicing counter, a key piece to be sure to pass through the true solar diameter after measuring several chords above and below. The whole system (about 40 kg) was rotating around the optical axis (courtesy: OCA).



Figure 24: J. Rösch (left) and J.P. Rozelot (right) discussing about the heliometer, inside the Turret-Dome where the instrument was mounted (courtesy: OCA).

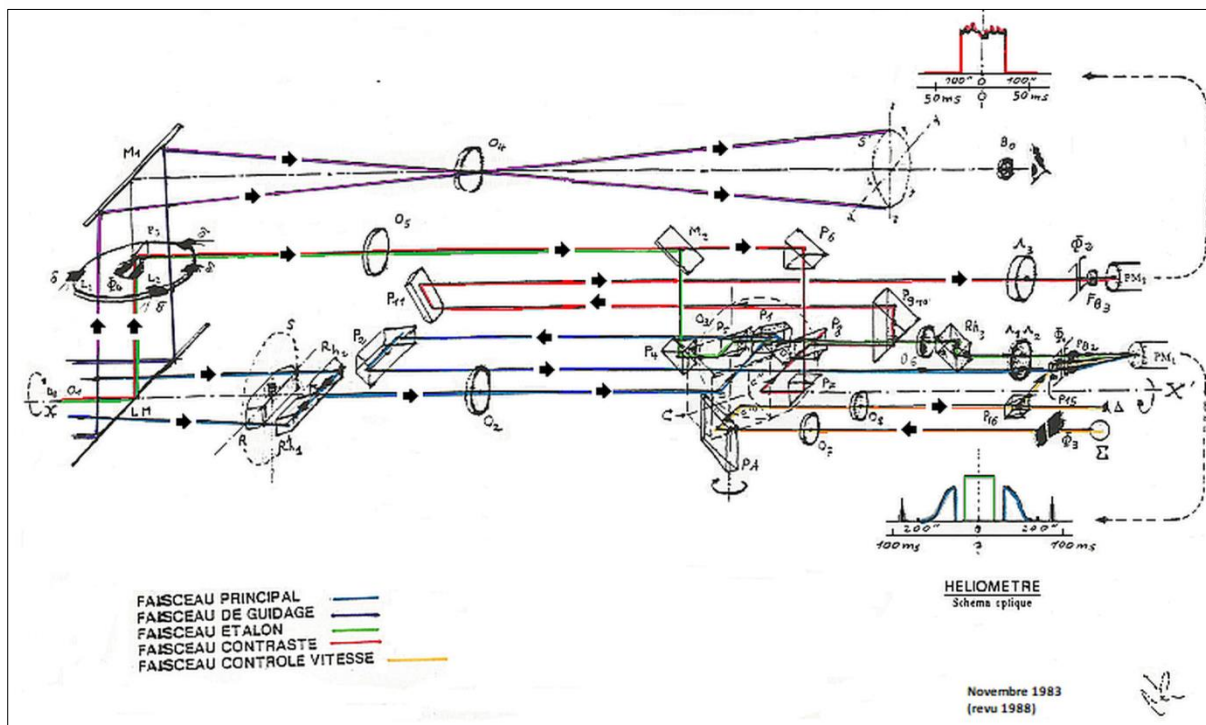

Figure 25: Diagram of the heliometer. Original drawing, dated and signed by J. Rösch, 1983, revised 1988 (courtesy: OCA).

the emphasis was placed on the relative measurements of the distances between the inflection points at any heliographic latitudes, the final objective remaining to detect the real shape of the Sun. According to Davoust (2014), the very first scans were obtained on 8 September 1984. Since then, no new real observational campaign was made until 1993, when the team composed of J. Rösch, J.P. Rozelot (Figure

24), Hervé Deslandes and Valérie Desnoux completely refurbished the instrument (Rösch et al., 1996).

The instrument is very complex and was a concentrated package of ingenuity and subtleties that only J. Rösch could imagine (Figure 25). It consisted of a box, one meter long and about $0.2 \times 0.2 \text{ m}^2$ section, housing the mechan-

ical and optical components. It rotated around the optical axis of the primary objective, thus allowing to measure the diameters of the Sun in any position angle. The radiation entering the heliometer was reduced to the minimum, the excess evacuated by means of a cooling box. Two pairs of photodiodes controlled the guiding in right ascension (α) and declination (δ).

As previously explained, the opposite cross sections of the solar limb were transported closer to the optical axis, since most of the solar diameter is not used. The key point is that the occulted central part, associated with two ‘optical tops’ (Figure 22), is constant regardless the measurement. It thus provided an internal reference frame allowing a perfect calibration of the scans. Each one lasted about 200 ms; an example of an east-west direction scan is displayed in Figure 22. Before reaching the heliometer slit, the beam went through a narrow-band interference filter, centered in the green at 5058 Å (12 Å FWHM), in a part of the solar spectrum free of absorption lines.

On 10 September 1996 Rozelot and Damiani (2011) measured a flattening of 8.9 ± 2.1 milli-arcsec (mas), in perfect agreement with other measurements, as those of Kuhn et al. (1998) onboard SOHO which gave 8.7 ± 2.8 mas (on 19 and 20 March 1997). The flattening measures the difference between the equatorial and polar radius, expressed in mas. This difference is sometimes normalized to the equatorial radius, to obtain the oblateness, a very small and unitless number of about $8.56 \cdot 10^{-6}$. J.P. Rozelot soon reoriented the observing program towards the determination of solar gravitational moments (Rösch and Rozelot, 1997), which was extremely fruitful. The shape of the Sun, as for the Earth or any star, reflects what is going on at the surface or at depth (differential and meridional rotation, subtle motions of magnetic elements, core rotation ...). The resulting non-circular shape is ascribed by the so-called gravitational moments of successive orders, which are at the cutting edge of the detection due to their faint order of magnitude (10^{-7}). The challenge is thus to detect the true shape with enough accuracy to get information relevant for astrophysical purposes, extending as far as general relativity (Eren and Rozelot, 2020).

7.1 Analysis of the Heliometer Data

The adopted observational definition of a solar diameter is the angular distance (for a terrestrial observer, it needs to report the measurement at one Astronomical Unit) between the points on opposite limbs where the brightness gradient is maximum (Rösch and Yerle, 1983). Other def-

initions could be used, for instance the location of the limb at the minimum of temperature, or an equipotential level of gravity which defines the outer shape (Rozelot et al., 2017). A specific advantage of the limb profile method is that each individual scan carries its own measurement of the blurring effect through the maximum gradient of the profile, justifying the correcting procedure explained below.

To be sure to measure the solar diameter at a given heliographic latitude, several successive chords were recorded below and above to rebuild the limb (a digital counter allowed to locate the chords). The ‘true’ diameter was derived from the maximum of the quadratic fit of the data, with an error smaller than 0.002". Each data point was the result of 44 scans acquired in one direction (for instance west-east) and 44 others in the reverse direction (east-west). Using this process we could only obtain daily no more than a dozen diameters around the Sun, the turbulence becoming too strong after noon. The seeing was monitored for each scan and was deduced from the deconvolution by a Fried short exposure time function (approximated by a Gaussian model) plus the transfer function of the system. The fitting of the data gave an adjustment coefficient, checked for each scan, which was rejected below 0.9. Finally, knowledge of the seeing allowed us to compute the parasitic shift of the inflexion point towards the disk. It was an important correction which could reach 80 mas for a seeing of 1.5". Three other corrections, suggested by J. Rösch in 1985, were also applied: the yearly oscillation of the projection onto the celestial sphere of the polar axis of the sun (P angle), the topocentric factor and the atmospheric refraction. The first one is directly given by ephemeris, while the second one was computed using the exact longitude and latitude of the center of the dome, together with the altitude of the equatorial table. For the third one, the formulas given by Smart (1956) in his *Text-Book on Spherical Astronomy* were used.

7.2 Heliometer Observing Campaigns and Results

Observations began on 14 July 1993 and continued until 14 May 1995. During that time 42,812 scans were acquired. For example, the campaign of June 1994 provided series of scans for which the shift of the inflection point was not more than 0.014", a precision required to specify the solar flattening without any ambiguity. The correlation between the site's seeing and the measurement errors is shown in Figure 26. New campaigns were made each year from 2000 to 2008. Unprecedented weather conditions were encountered in September

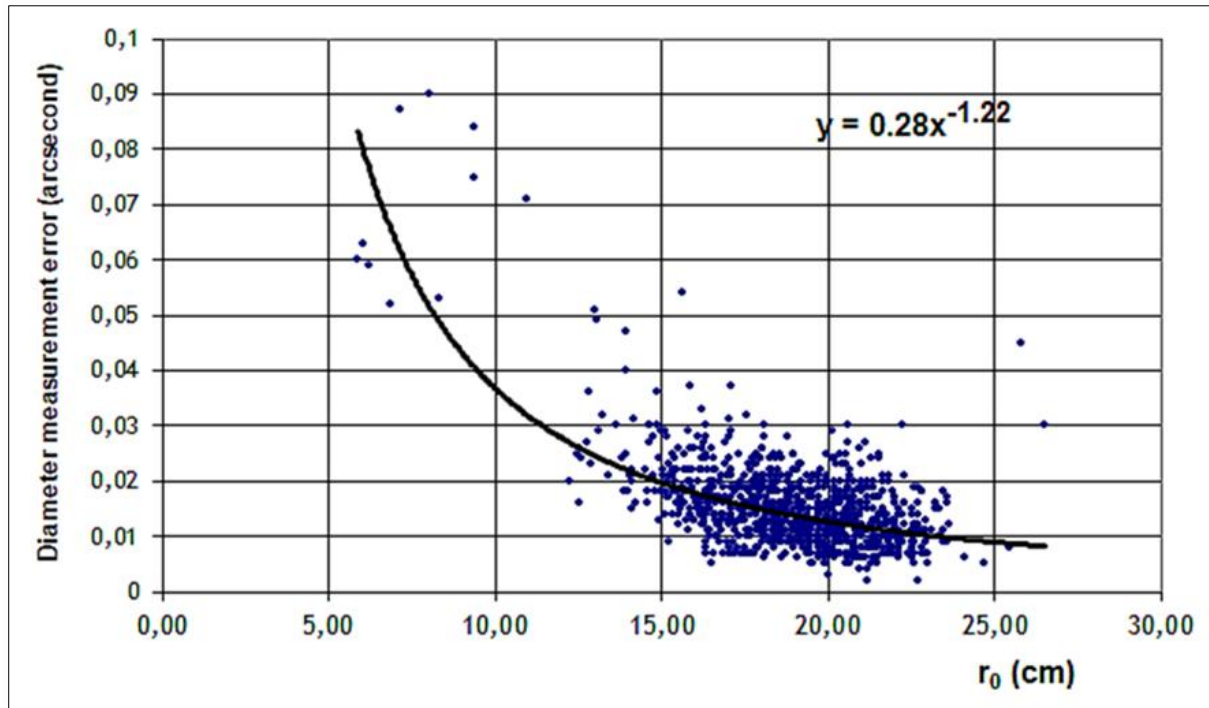

Figure 26: Error in diameter measurements as a function of the Fried parameter r_0 (a parameter characterizing the turbulence, values above 15 cm correspond to good seeing conditions). Data recorded on 6 September 2001, with exceptional weather conditions. Note that the theoretical diffraction limit of the refractor is $0.256''$. The exponent of the fitting is 1.22, close to the theoretical value (1.20). Two points have been obtained for high values of r_0 (i.e., 25.7 and 26.4 cm), which are out of the fitting and probably erroneous (after Rozelot et al., 2003: 45).

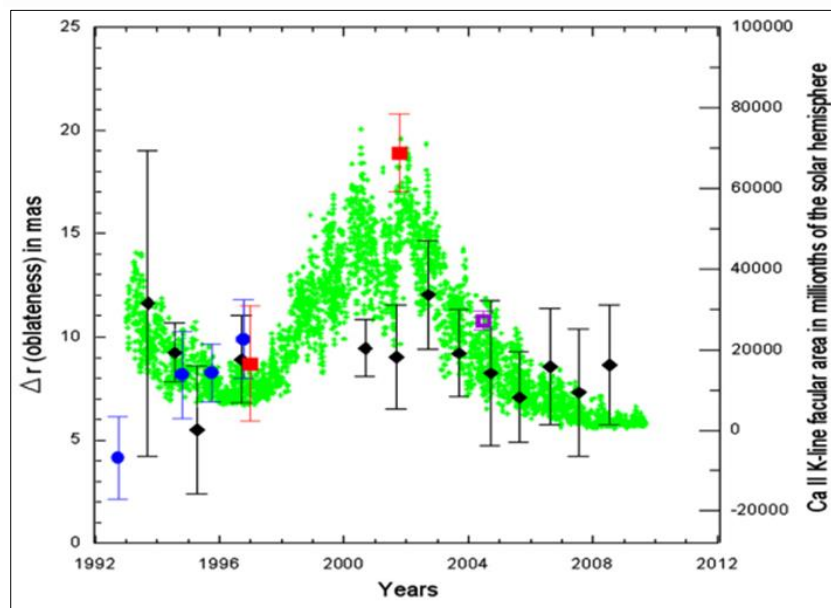

Figure 27: Solar flattening (difference Δr between the equatorial and polar radius) as deduced from Pic du Midi observations (diamonds), Solar Disk Sextant (SDS) balloon flights (circles), SOHO-MIDI (squares) and RHESI space measurements (hollowed out square), plotted together with the faculae area index (green) produced by San Fernando Observatory (USA), as a function of time (after Damiani et al., 2011: 247).

2000 ($r_0 = 14$ cm) and 2001 ($r_0 = 18$ cm). Results were published by Rozelot et al. (2003; 2009) and Damiani et al. (2011). In this last-mentioned paper (see their Table 2) the weighted values of the measured solar oblateness are presented. It was found that a mean difference between the equatorial and polar radii could not exceed 11 mas as an upper limit, the most probable value being 8.83 ± 2.85 mas, demonstrating that values of Dicke and Goldenberg

(1967) obtained in 1966 (41.9 ± 3.3 mas) were largely over-estimated. In comparison, Irbah et al. (2019) found with the space-borne Helioseismic and Magnetic Imager (HMI) instrument onboard the SDO satellite an average of 8.8 ± 0.8 mas in perfect agreement with us.

However, the annual values obtained between 1993 and 2009 suggested a temporal variation, as seen in Figure 27, where heliometer data points were plotted together with re-

sults obtained by space-borne missions (MDI/SOHO, SDS, RHESSI). A dependence with the solar cycle has been detected and analyzed by Emilio et al. (2007) and Rozelot et al. (2009), which suggested the following mechanism to explain these variations: at epochs of high activity, the first solar gravitational moment has a significant effect, but in periods of low activity, the second is predominant, and this generates a decrease of the oblateness. The combination of the two terms leads to a complex shape (a bulge at the equator and a depression at mid-latitudes), suggesting that the outer solar atmosphere expands non-homologously during the cycle (Lefebvre et al., 2007). Hence, Figure 26 emphasizes the great contribution of the heliometer to the determination of a fundamental parameter of the Sun.

8 CONCLUDING REMARKS

The Pic du Midi Turret-Dome was active during five decades (1960–2010) in the domain of high-resolution solar physics. An incredibly original, exhaustive and sophisticated instrumentation has been developed both in imagery and spectroscopy, as well as in imaging spectroscopy and polarimetry, coronagraphy and heliometry.

The Turret-Dome was intensively used to probe the convective cells at the surface of the Sun (granulation) until the launch of Hinode in 2006 by JAXA, which was the first space-borne telescope with the spatial resolution of the Pic du Midi. The Turret-Dome provided observations of solar activity events during coordinated campaigns with the Solar Maximum Mission (SMM) satellite (NASA) in the eighties, and with

the Solar and Heliospheric Observatory (SOHO, ESA/NASA) in the nineties. This instrument was the precursor of the THEMIS telescope (INSU/CNRS, 2000) still in activity at the Teide Observatory (Tenerife).

The Turret-Dome produced about one hundred scientific papers and allowed us to explore, test and develop many innovative techniques dedicated to high cadence and high-resolution solar observations, which are now implemented and used on THEMIS, together with original polarimetric methods. The experience acquired at the Turret-Dome inspired the conception of the SOT on-board Hinode and will also benefit the construction of the giant European Solar Telescope (EST), which will hopefully operate at La Palma (Canary Islands) at the end of the present decade. The coronagraphic program for the study of the highly ionized emission lines will be resumed on the Indian ADITYA-L1 satellite ('Sun', in Sanskrit) after 2022 (Singh et al., 2019), and the solar flattening measurements continue with HMI onboard the SDO mission (NASA).

9 ACKNOWLEDGEMENTS

This paper is dedicated to the memory of Jean Rösch (1915–1999) and Zadig Mouradian (1930–2020) who respectively introduced in France high spatial resolution imagery and spectroscopy in solar physics.

We thank the referees for very helpful comments and suggestions. We are also indebted to the numerous technical teams of Bagnères de Bigorre, Pic du Midi and Paris Observatories that worked for the Turret-Dome during five decades.

10 REFERENCES

- Damiani, C., Rozelot, J.P., Lefebvre, S., Kilcik, A., and Kosovichev A.G., 2011. A brief history of the solar oblateness. A review. *Journal of Atmospheric and Solar-Terrestrial Physics*, 73, 241–250. DOI: 10.1016/j.jastp.2010.02.02.
- Davoust, E., 2014. *Pic du Midi. One Hundred Years of Life and Science at a High-Altitude Observatory*. Toulouse, MSM Editions (English translation by Barbara Jachowicz).
- Del Zanna, G., and De Luca, E.E., 2018. Solar coronal lines in the visible and infrared: a rough guide. *The Astrophysical Journal*, 852(1), article id. 52, 15 pp. DOI: 10.3847/1538-4357/aa9edf.
- Dicke, R.H., and Goldenberg, H.M., 1967. Solar oblateness and General Relativity. *Physical Review Letters*, 18(9). DOI: 10.1103/PhysRevLett.18.313.
- Dollfus, A., Colson, F., Crussaire, D., and Launay, F., 1985. A monochromator for solar quantitative imagery: the instrument FPSS. *Astronomy and Astrophysics*, 151, 235–253.
- Emilio, M., Bush, R.I., Kuhn, J., and Sherrer, P., 2007. A changing solar shape. *The Astrophysical Journal*, 660, L161–L163. DOI: 10.1086/518212.
- Eren, S., and Rozelot, J.P., 2020. Exploring the temporal variation of the solar quadrupole moment from relativistic gravitation contributions: a fortuitous circumstance? *Advances in Space Research*, 65, 2821–2827.
- Espagnet, O., 1994. *La Granulation Solaire: Origine, Pénétration dans la Photosphère et Interaction avec les Oscillations de 5 min*. PhD Thesis, Toulouse University 3, Toulouse, France (in French).
- Irbah, A., Mecheri, R., Damé, L., and Djafer, D., 2019. Variations of solar oblateness with the 22 year magnetic cycle explain measurements apparently inconsistent. *Astrophysical Journal Letters*, 875(2), article id. L26, 7 pp. DOI: 10.3847/2041-8213/ab16e2.
- Kuhn, J.R., Bush, R.I., Scheick, X., and Scherrer, P., 1998. The Sun's shape and brightness. *Nature*, 392, 155–157. DOI: 10.1038/3236.

- Lefebvre, S., Kosovichev, A.G., and Rozelot, J.P., 2007. Helioseismic test of nonhomologous solar radius changes with the 11 year activity cycle. *The Astrophysical Journal*, 658, L135–L138, DOI: 10.1086/515394.
- Leroy, J.L., and Rösch, J., 1970. Un programme de photographie en lumière monochromatique pour les années 1973–1976. *Solar Physics*, 15, 383–386 (in French).
- Malherbe, J.-M., Roudier, Th., Moity, J., Mein, P., and Muller, R., 2004. High resolution solar magnetometry with the spectrograph of the Pic du Midi turret dome. *Astronomy and Astrophysics*, 427, 745–753.
- Malherbe, J.-M., Moity, J., Arnaud, J., and Roudier, Th., 2007a. First observations of the second solar spectrum with spatial resolution at the lunette Jean Rösch. *Astronomy and Astrophysics*, 462, 753–762.
- Malherbe, J.-M., Roudier, Th., Moity, J., Mein, P., Arnaud, J., and Muller, R., 2007b. Spectropolarimetry with liquid crystals. *Memorie delle Società Astronomica Italiana*, 78, 203–209.
- Mein, P., 1977. Multichannel subtractive spectrograph and filament observations. *Solar Physics*, 54, 45–51.
- Mein, P., 1980. Multichannel Subtractive Double Pass Spectrograph. In Moriyama and Hénoux, 285–294.
- Mein, P., and Mein, N., 2020. Raymond Michard and his solar physics group at Paris-Meudon Observatory. *Journal of Astronomical History and Heritage*, 23, 582–600.
- Mein, P., Malherbe, J.M., Sayède, F., Rudawy, P., Phillips, K., and Keenan, F., 2021. Four decades of advances from MSDP to S4I and SLED imaging spectrometers. *Solar Physics*, 296, 30–54.
- Moriyama, F., and Hénoux, J.C., (eds.), 1980. *Proceedings of the Japan France Seminar on Solar Physics*. Tokyo, Tokyo Astronomical Observatory.
- Mouradian, Z., Chauveau, F., Colson, F., Darré, G., Kerlirzlin, P., and Olivieri, G., 1980. The new solar spectrograph at Pic du Midi Observatory. In Moriyama and Hénoux, 271–277.
- Muller, R., 1981. The fine structure of sunspot penumbras. In Cram, L.E., and Thomas, J.H. (eds.). *Proceedings of the Physics of Sunspots. Sunspot N.M., July 14–17 1986*. Sunspot, Sacramento Peak National Observatory. Pp. 340–343.
- Muller, R., 1983. The dynamical behaviour of facular points in the quiet photosphere. *Solar Physics*, 85, 113–121.
- Muller, R., and Roudier, Th., 1984. Variability of the quiet photospheric network. *Solar Physics*, 94, 33–47.
- Noëns, J.C., and Rozelot, J. P., 1974. Observations of the line 7892 Å of FeXI by means of Pic du Midi Observatory coronagraph. *Astronomy and Astrophysics*, 30, 81–85.
- Rieutord, M., Roudier, Th., Rincon, F., Malherbe, J.M., Meunier, N., Berger, T., and Frank, Z., 2010. On the power spectrum of solar surface flows. *Astronomy and Astrophysics*, 512, 4–15.
- Rondi, S., 2006. *CALAS, Une Caméra pour l'Étude des Grandes Échelles de la Surface Solaire*. PhD Thesis, Toulouse University 3, Toulouse, France (in French).
- Rösch, J., and Yerle, R., 1981. Solar diameter measurements: a new approach. In Dunn, R.B. (ed.), *Solar Instrumentation: What's Next? Proceedings of the Conference held in Sunspot, New Mexico, Sacramento Peak National Observatory, October 14–17, 1980*. Sunspot, Sacramento Peak National Observatory. Pp.367–378.
- Rösch, J., and Yerle, R., 1983. Solar diameter(s). *Solar Physics*, 82, 139–150.
- Rösch, J., Rozelot, J.P., Deslandes, H., and Desnoux, V., 1996. A new estimate of the quadrupole moment of the Sun. *Solar Physics*, 165, 1–11. DOI: 10.1007/BF00149086.
- Rösch, J., and Rozelot, J.P., 1997. An upper bound to the solar oblateness. *Solar Physics*, 172, 11–18. DOI: 10.1023/A:1004919823102.
- Roudier, Th., Malherbe, J.M., Vigneau, J., and Pfeiffer, B., 1998. Solar mesogranule lifetime measurements. *Astronomy and Astrophysics*, 330, 1136–1144.
- Roudier, Th., Malherbe, J.-M., Mein, P., Muller, R., Coutard, Ch., Lafon, M., and Grimaud, F., 2003. High spatial resolution capabilities of Doppler measurements with the Pic du Midi spectrograph. *Astronomy and Astrophysics*, 409, 793–797.
- Roudier, Th., and Muller, R., 2004. Relation between families of granules, mesogranules and photospheric network. *Astronomy and Astrophysics*, 419, 757–762.
- Roudier, Th., Malherbe, J.-M., Moity, J., Rondi, S., Mein, P., and Coutard, Ch., 2006. Sub arcsec evolution of solar magnetic fields. *Astronomy and Astrophysics*, 455, 1091–1098.
- Rozelot, J.P., 1969. Le Fe XII dans la couronne d'émission. *Solar Physics*, 8, 91–103 (in French).
- Rozelot, J.P., 1970. Study of ionized iron under coronal conditions. Coronagraph observations of the six coronal ions of the iron group. *Astronomy and Astrophysics*, 6, 18–26.
- Rozelot, J.P., 1972. Analyse des renforcements coronaux à travers quelques acquisitions spectroscopiques récentes des émissions monochromatiques du fer ionisé (X à XV). *Solar Physics*, 22, 88–113 (in French).
- Rozelot, J.P., and Despiau, R., 1972. Adaptation de la caméra électronique au coronographe. *Comptes Rendus Hebdomadaires Académie des Sciences*, 275, 613–616 (in French).
- Rozelot, J. P., and Noëns, J.C., 1975. Intensity ratios of forbidden coronal lines of Fe XI at 7892 Å and 3987 Å. *Journal of Quantitative Spectroscopy and Radiative Transfer*, 15, 379–384. DOI: 10.1016/0022-4073(75)90055-2.
- Rozelot, J.P., Lefebvre, S., and Desnoux, V., 2003. Observations of the solar limb shape distortions. *Solar Physics*, 217, 39–52. DOI: 10.1023/A:102736380304.
- Rozelot, J.P., Damiani, C., and Pireaux, S., 2009. Probing the solar surface: the oblateness and astrophysical consequences. *The Astrophysical Journal*, 703, 1791–1796. DOI: 10.1088/0004-637X/703/2/1791.
- Rozelot, J. -P., and Damiani, C., 2011. History of solar oblateness measurements and interpretation. *The European Physical Journal*, 36, 407–436. DOI: 10.1140/epjh/e2011-20017-4.
- Rozelot, J.P., Kosovichev, A.G., and Kilcik, A., 2017. A brief history of the solar diameter measurements: a critical quality assessment of the existing data. In Rozelot, J.-P., and Babayev, E. (eds.), *Variability of the Sun and Sun-*

- like Stars: From Asteroseismology to Space Weather, Baku, Azerbaijan, 6–8 July 2015.* Paris, EDP Sciences. Pp. 89–108. ISBN: 978-2-7598-2195-2 and arXiv:1609.02710v1.
- Semel, M., 1980. Un analyseur précis de polarisation optique. *Astronomy and Astrophysics*, 91, 369–371 (in French).
- Singh, J., Prasad, B., Venkata, S., and Kumar, A., 2019. Exploring the outer emission corona spectroscopically by using Visible Emission Line Coronagraph (VELC) on board ADITYA-L1 mission. *Advances in Space Research*, 64, 1455–1464.
- Smart, W.M., 1956. *Text-book on Spherical Astronomy*. Cambridge, Cambridge University Press.
- Yerle, R., 1981. Solar oscillations and limb darkening fluctuations. *Astronomy and Astrophysics*, 100, L23–L25.



Dr Thierry Roudier was born in 1957, and started his thesis at the Pic du Midi Observatory in 1983 under the supervision of Richard Muller. He got the degree of Docteur en Astrophysique in 1986 and started his career as a solar physicist at the Centre National de la Recherche Scientifique (CNRS) the same year. He built the national solar data base BASS2000 in 1996 and contributed to the management and exploitation of the French solar telescope THEMIS.

Thierry devoted 25 years to observations and instrumentation at the Jean Rösch Lunette of the Pic du Midi, including 10 years as Manager. He was PI of international Ground-Space observations (JOP 178) to study the generation of filament flares via the action of photospheric motions. He made available to the international community his Coherent

Structure Tracking software in 2020 at MEDOC (IAS). His researches were devoted to understanding the dynamics of the photosphere in relation to the solar activity cycle. The main scientific objective was to determine the nature of the extremely non-linear and multiscale turbulent-convection in the quiet Sun as well as to understand the mechanisms that diffuse the magnetic field at the solar surface.



Dr Jean-Marie Malherbe was born in 1956 and is an astronomer at the Observatoire de Paris. He got the degrees of Docteur de 3ème cycle in 1983 and Docteur d'Etat ès Sciences in 1987.

He first worked on solar filaments and prominences using multi-wavelength observations. He proposed models and MHD 2D numerical simulations for prominence formation, including radiative cooling and magnetic reconnection. He used the MSDP spectrographs of the Meudon Solar Tower, the Pic du Midi Turret Dome, the German Vacuum Tower Telescope and THEMIS (Tenerife) and developed polarimeters. More recently, he worked closely with Th. Roudier on surface structures of the quiet Sun, using HINODE (JAXA), SDO and IRIS (NASA) space-borne telescopes. He is currently finishing two instruments: the first one is an

automated station, dedicated to the solar activity survey at CALERN Observatory, and the second one is related to the dynamics of hot coronal loops (1-2 MK) and based on the latest advances of the MSDP technique proposed by P. Mein.



Dr Jean Pierre Rozelot began his career as a solar physicist at the Pic du Midi Observatory in 1964, by doing a thesis under the supervision of Jean Rösch. Then he completed as a post-doctoral fellow at High Altitude Observatory (USA). He was director of CERGA (Centre d'Etudes et de Recherches en Géodynamique et Astronomie in Grasse) from 1982 to 1987, then deputy director of the OCA (Observatoire de la Côte d'Azur in Nice) in 1988. From 1996 to 2012, he was deputy director at the French Agency CNRS-INSU, part-time, for training in astronomy.

In 1996, he developed with Jean Rösch the heliometer of the Pic du Midi, for the measurement of the shape of the Sun, which ultimately allowed access to gravitational moments. His work, then carried out within an international team (Stanford, BBSO and NJIT in the USA, Turkey, Bulgaria, Iran) allowed him to highlight the key role of the NSSL (Near Sub-Surface Layer) called the 'leptocline'.

He is the author of approximately 350 papers published in international journals. Since his retirement, he has continued to work supervising theses (more than 20 to date) and extending gravitational moments to stars, linking them to relativistic aspects. In 2008 he was elected a (non resident) member of the Accademia Gioenia di Scienze Naturali in Catania (Italy).



Dr Pierre Mein started research in the E. Schatzman Laboratory at the Institut d'Astrophysique de Paris. He obtained his PhD in 1966, and became an astronomer at the Paris Observatory in Raymond Michard's group. Pierre was Director of the Solar Department from 1975 to 1978.

His team showed that the solar corona could not be heated by acoustic waves. After 1977 he developed successive MSDP spectro-imaging devices at Meudon, Pic du Midi and Wroclaw (Poland), and also in Tenerife (Spain) on the German Vacuum Tower Telescope and on the French-Italian THEMIS telescope. Many papers followed, in collaboration with international teams with space vehicles, taking advantage of the high speed of the MSDP. In addition to oscillations, many solar structures were investigated, such as sunspots, flares, filaments, prominences and jets.

After retirement, Pierre Mein continued to work with his colleagues on software for data processing and fast inversion of Zeeman line profiles, and to develop new spectro-imagers for solar eclipses and for exoplanets and galaxies.



Dr Richard Muller starts his career in 1969 as a solar physicist at the Pic du Midi Observatory. In 1977 he defended his thesis under the supervision of Jean Rösch.

In 1970 he succeeded to get an outstanding 3-hours time series of a large and spectacular sunspot, with a 0.3" spatial resolution. Dr Muller visited the Fraunhofer Institut in Freiburg (Germany) in 1971 and the Observatory of the University of Göttingen (Germany) in 1972. He discovered that the penumbral filaments are made up of aligned bright grains that move towards the umbra. Then his main interest shifted to the observation and the study of the small magnetic elements concentrated in the intergranular lanes of the convective granulation at the solar surface. Their observation was improved by the use of a filter centered on the G-band lines of the solar spectrum, at 403.5 nm. Many of their properties were discovered, as well as of the way in which they interacted with the convective granules. Dr Muller also investigated the properties of granulation and mesogranulation in collaboration with T. Roudier. During this period he visited the Sacramento Peak Observatory (USA) and the University of Kyoto (Japan) as an associated scientist.

From 1988 to 1995 Dr Muller was Director of a Research Laboratory of the CNRS. For more than 25 years he was responsible for the Turret Dome, and during that period he contributed to the extension of its use by introducing several new instruments (e.g. spectrograph and filters).