

European catfish density estimation using unnamed aircrafts and underwater census

C Boisneau*, D Conte**, P Gaucher**, Y Guerez***

* UMR CITERES, ** EA LIFAT, *** CETU ELMIS

Université de Tours

Réponse appel à projet poissons migrateurs amphihalins sur le bassin de la Loire 2016

ALOSA 2016-17

Exotic species

- Theorie generalites
- impact

A recently introduced species in western Europe : *Silurus glanis*

- Species from Danube basin
- Carnivorous, opportunistic
- Eurytope
- Very adaptative
- Fourth biggest freshwater fish species



A recently introduced species in western Europe : *Silurus glanis*

- 1980-1990
- Top predator
- Catfish grouping near weirs and dams
- Predation on amphidromous species **camembert**

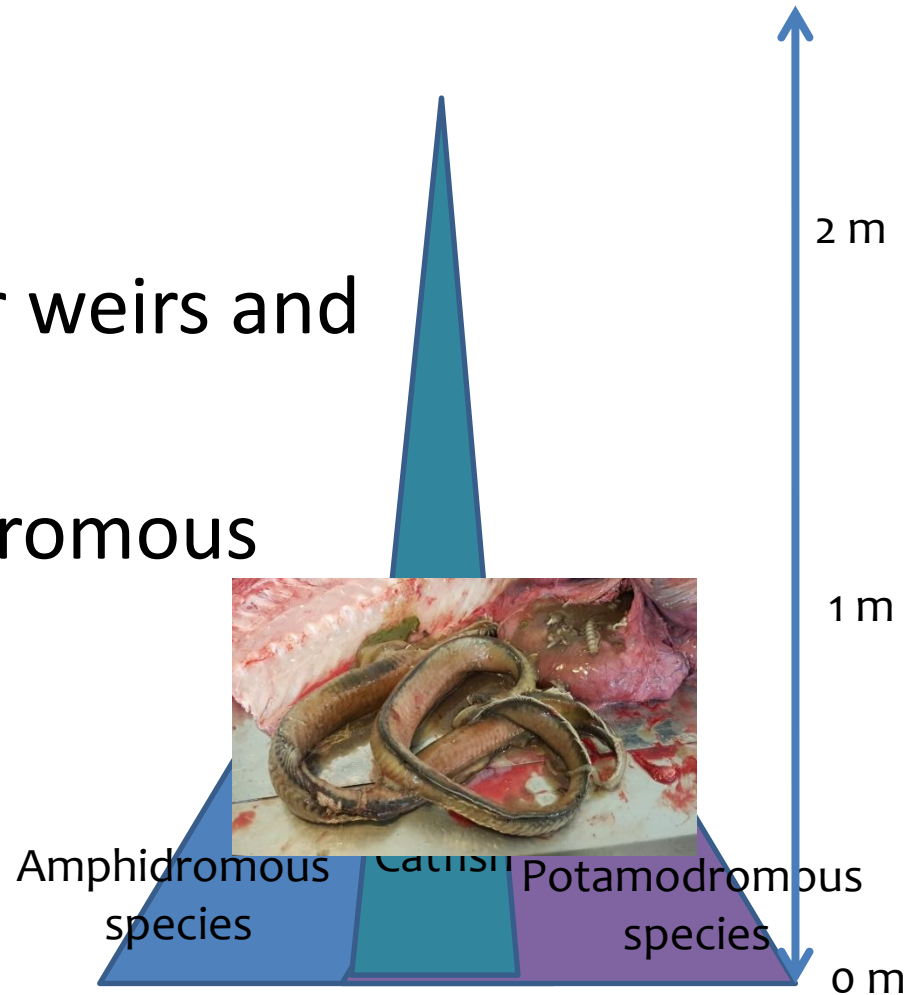

The river Loire

- The longest river with 10/11 amphidromous species

Spawning grounds more than 300 km from the sea

The main axis poorly impacted by dams

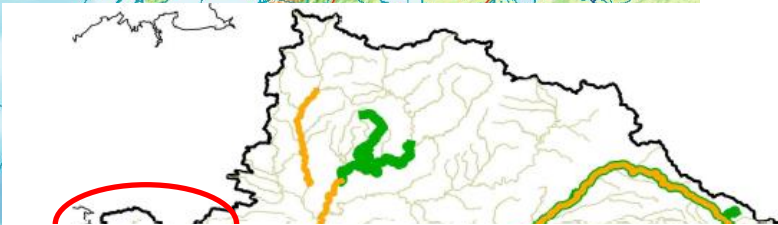

R duction de l'effet cumul  des obstacles   la montaison le long de l'axe Loire

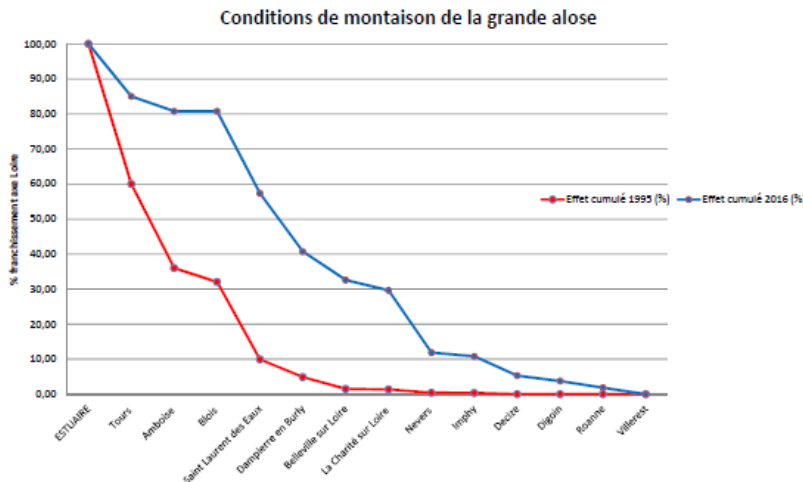

Aims

In sections of rivers without dams, weirs,

Evaluation of the density of catfish in the wild

H0 : density is 1 individual per ha or 10 ind/km

Is it possible to develop an automated method for estimating catfish densities?



Materials and methods

Sampling Sites





Le bassin Loire-Bretagne





C Boisneau© 2016/08/31

Technique choice for field sampling

Technique	Strengths	Weaknesses
 Electrofishing	Efficient along banks, in shallow places for fish < 0,8m	Not suitable for depth >1m, water velocity >1m/s catfish > 0.8m, inside wood piles
 Nets and fish trap	Efficient with a large pannel of mesh size, and mark recapture study	Long term study if MR, resting habitat not sampled, no information of group size
Aerial survey with UAV 	Quick and large survey, not very expensive, systematic	Banks and wood piles are not sampled
Underwater observations 	Access to logs, wood piles and banks, nearly systematic	Not suitable for water velocity >1m/s, catfish < 0.8m

Fish density : Procedure



Open water



Aerial survey methods

UAS



Images analysis

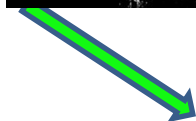
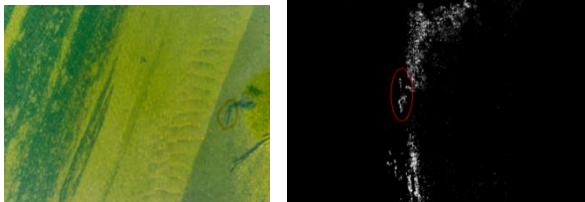

Wood piles



Underwater observations

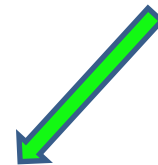

Numbers, distribution, surfaces, fish lengths ...



Density estimation

Image analysis

Open water



Visual selection of catfish and false positives

Analysis of images by an algorithm
of form recognition

Validation

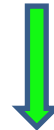

Numbers, distribution, surfaces, fish lengths, habitats,

Density : based on the approach for estimating people

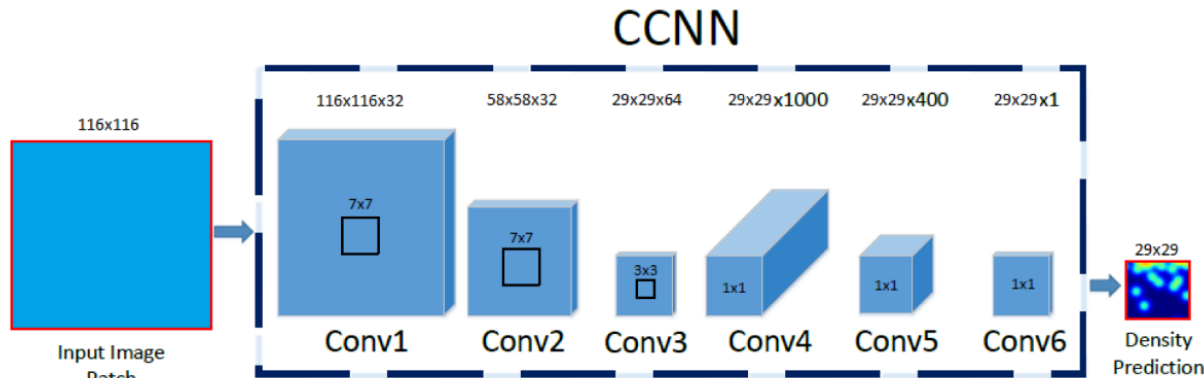
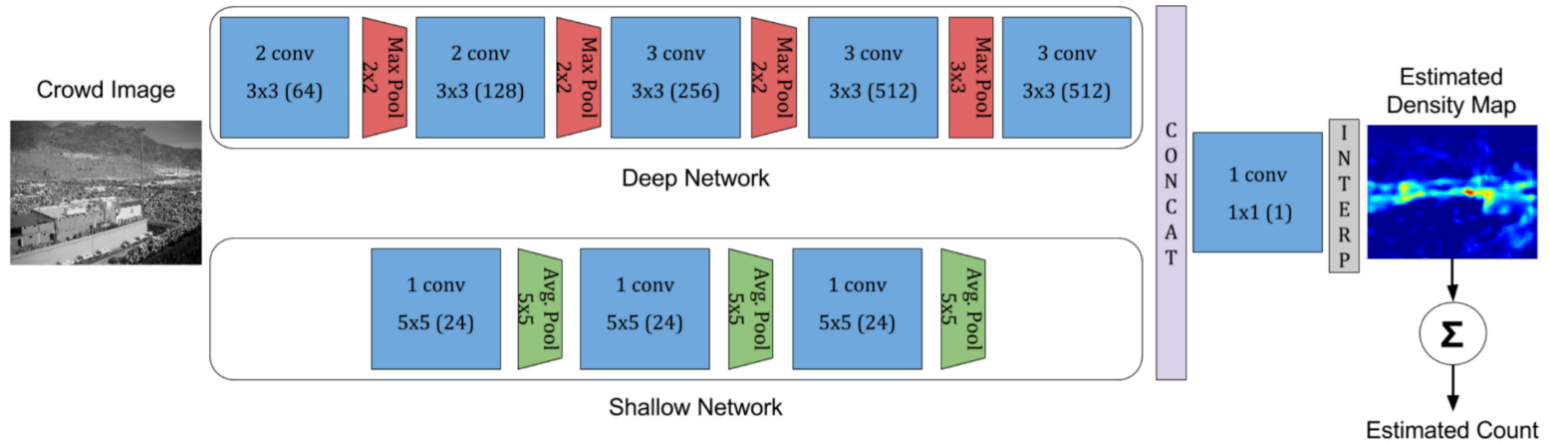

Learning

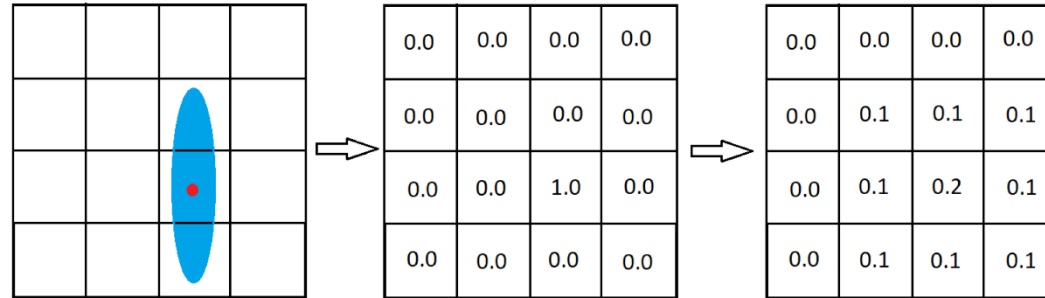

Image with only 1 fish



Image with 1 point in the center of the fish



Image after application of gaussian filter on the center of the fish



Calendar and Hydrology

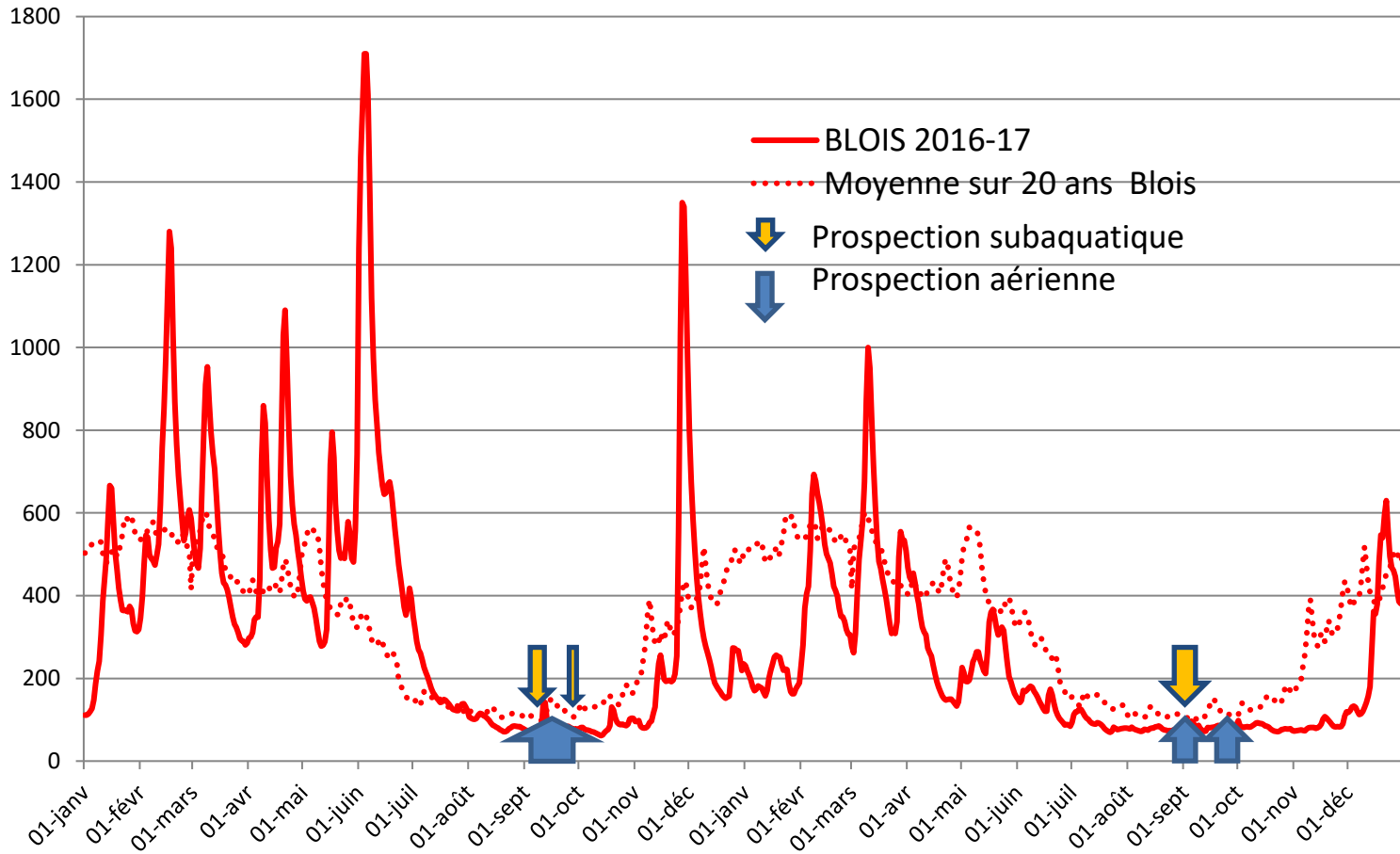



Results

Visual analysis

	2016	2017
Distance (km)	20,7	10,2
Numbers of images	13663	6876
Images containing fish	11,7 %	13 %
N catfish	278	39
False positives	56	8



Visual analysis

Detection and Under estimation

- Shadows of trees on water
- Reflections of clouds
- Wavelets due to the current
- Aggregation of fish
- Fish depth vs water transparency
- Colour of the substrate
- Artifacts : Trunks, logs, filamentous algae

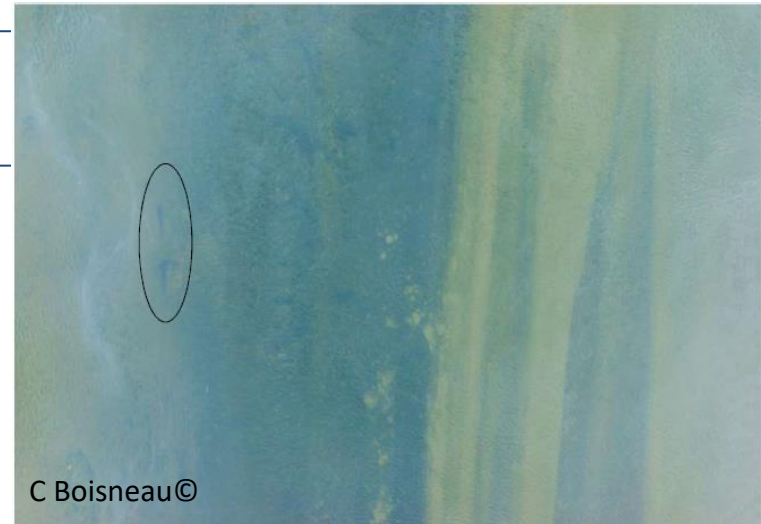



Automatic form recognition

Image	Estimation	Ground-truth
S1/DSC09754.jpg	101.97	2
S1/DSC09755.jpg	99.03	2
S1/DSC09768.jpg	104.23	13
S1/DSC09769.jpg	90.03	14
S1/DSC09770.jpg	96.45	1
S1/DSC09771.jpg	96.33	1
S1/DSC09773.jpg	88.60	1
S2/DSC00403.jpg	219.63	2
S3/DSC00592.jpg	102.89	1
MAE	106.92	
MSE	13017.92	

Table 1: Results on training set at epoch 0.

Image	Estimation	Ground-truth
S1/DSC09754.jpg	0.05	2
S1/DSC09755.jpg	0.02	2
S1/DSC09768.jpg	3.18	13
S1/DSC09769.jpg	0.00	14
S1/DSC09770.jpg	$4.38 \cdot 10^{-4}$	1
S1/DSC09771.jpg	$3.35 \cdot 10^{-5}$	1
S1/DSC09773.jpg	$7.82 \cdot 10^{-4}$	1
S2/DSC00403.jpg	0.01	2
S3/DSC00592.jpg	$7.2 \cdot 10^{-65}$	1
MAE	4.10	
MSE	42.33	

Table 3: Results on training set at epoch 40.



Automatic form recognition : Causes of absence of solution

- Lack of positive data in the learning phase
- Very high variability of image substrate (clear to almost black ranges)

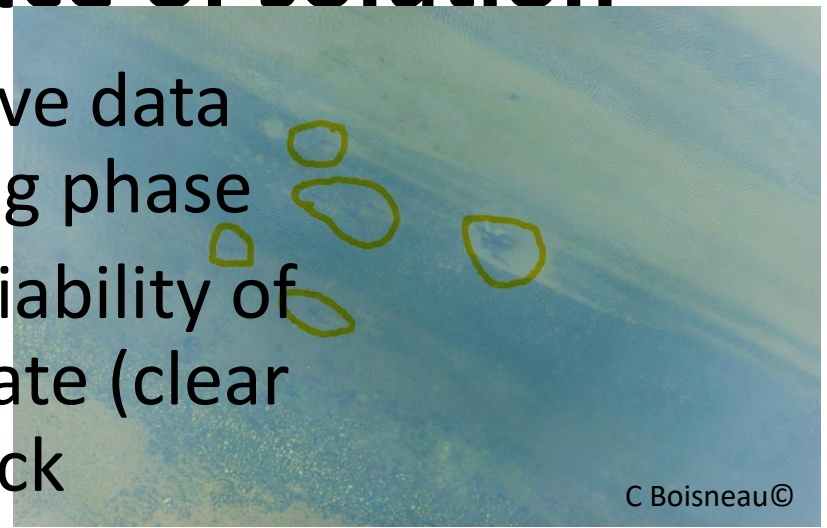
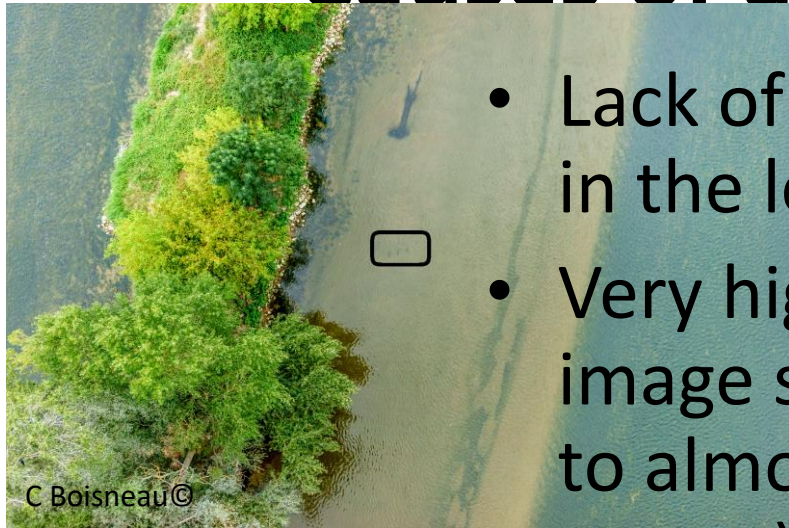

- Numerous artifacts (algae, trunks, vegetation, shade, etc.)

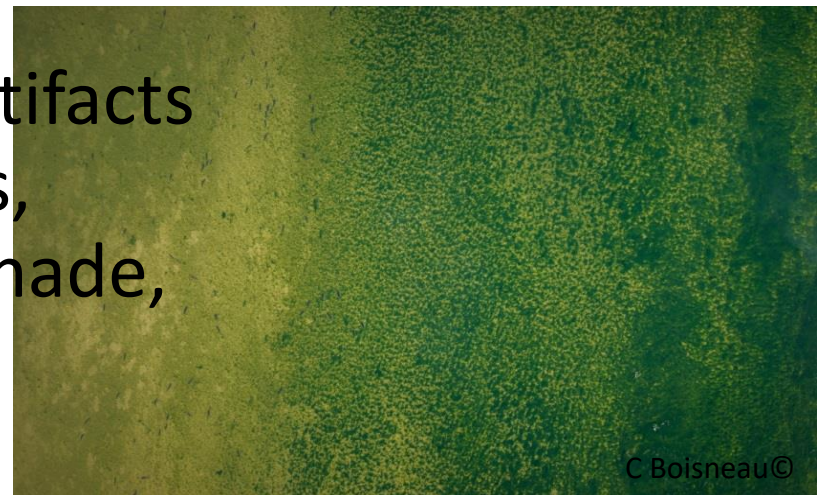

Image analysis

Open water

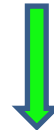

Image analysis

Visual selection of catfish and false positives

**Analysis of images by an algorithm
of form recognition**

Visual analysis by two independant observers



Numbers, distribution, surfaces, fish lengths, habitats,

Underwater observations

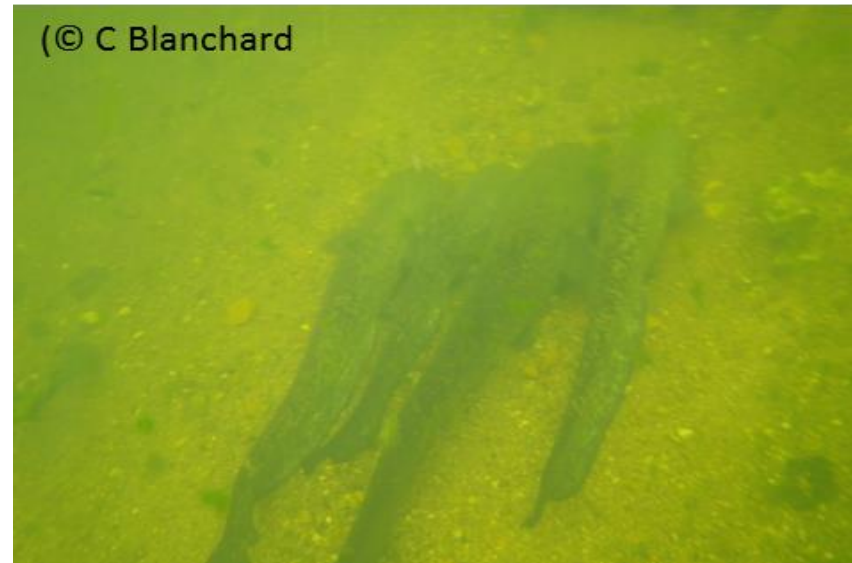

Habitats

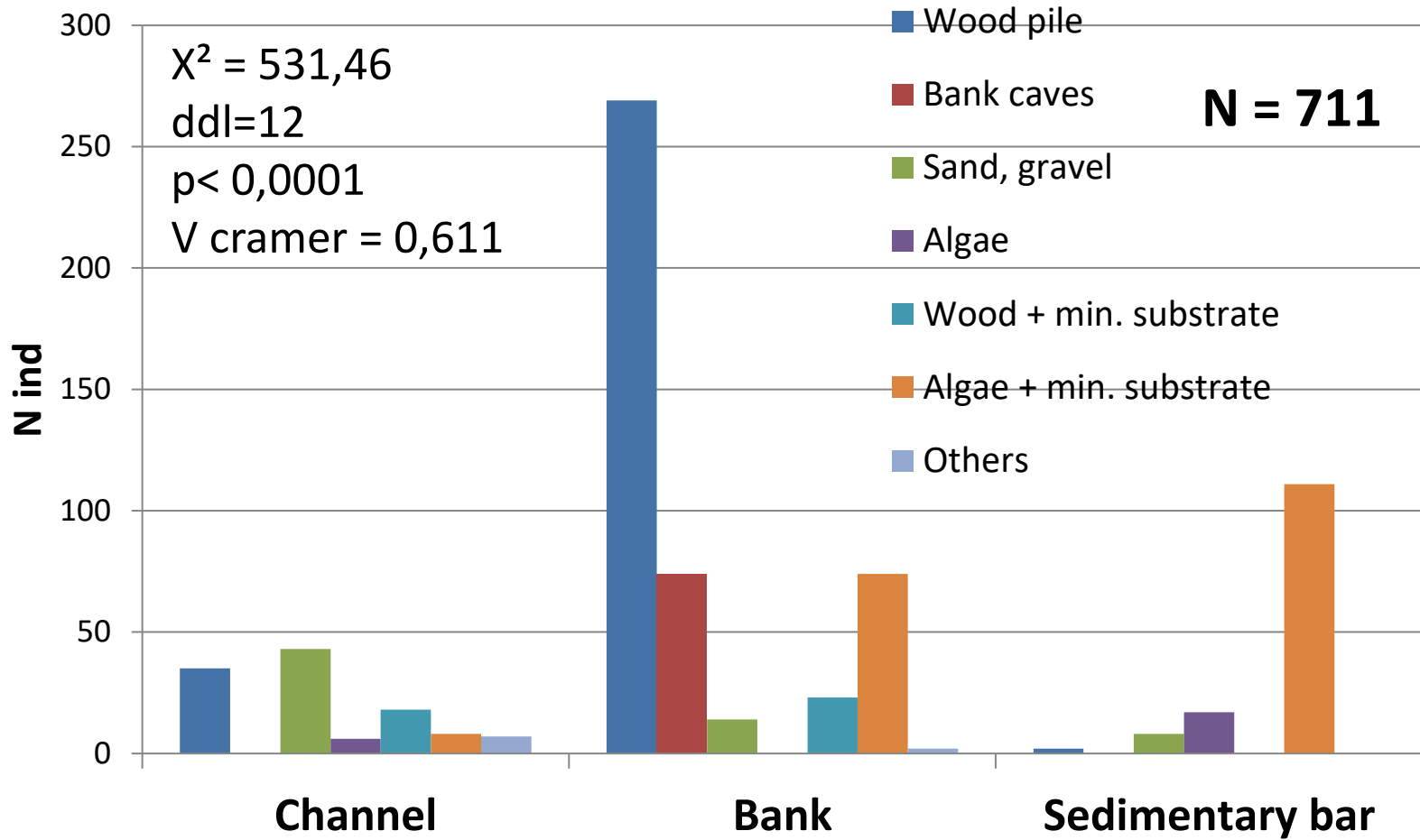

Group size

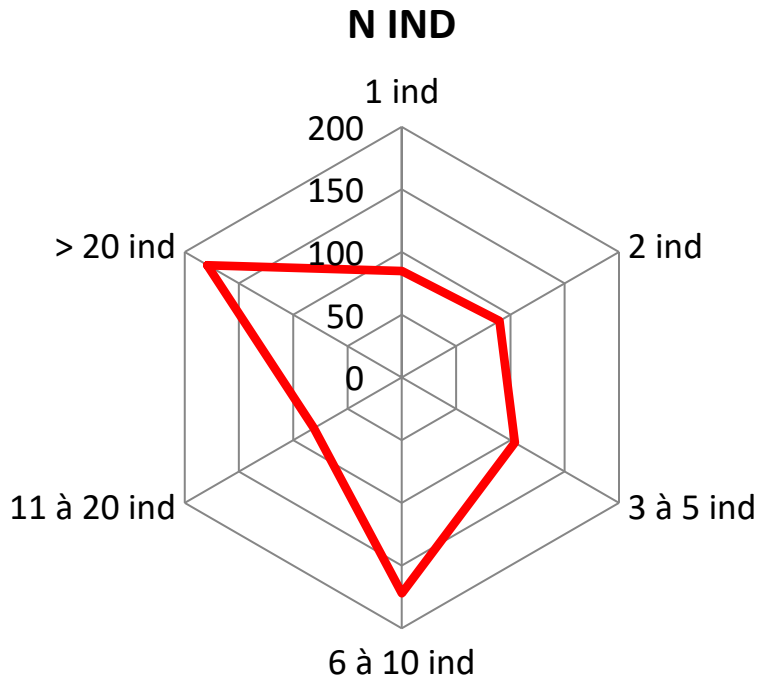

N = 711

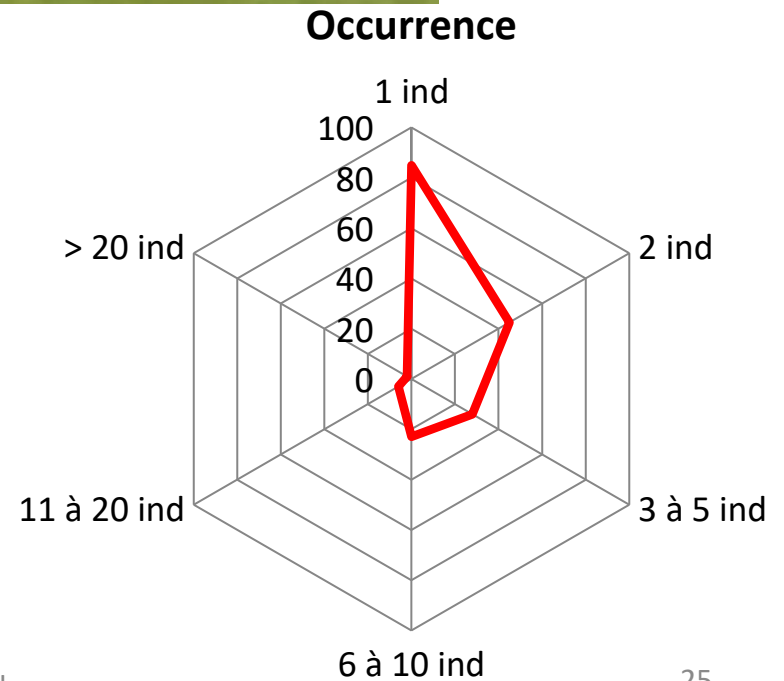
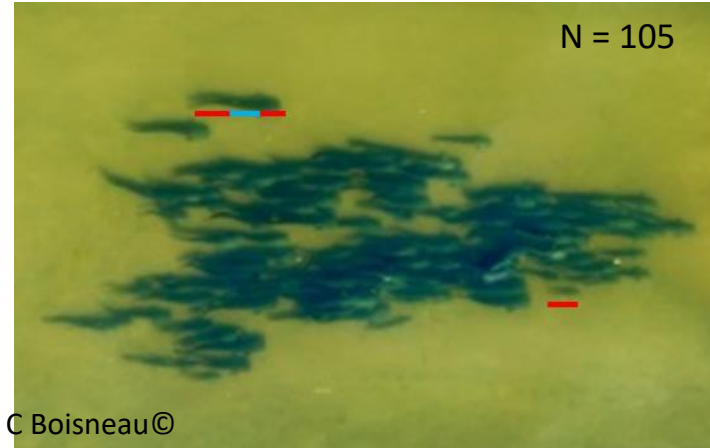

Individual size

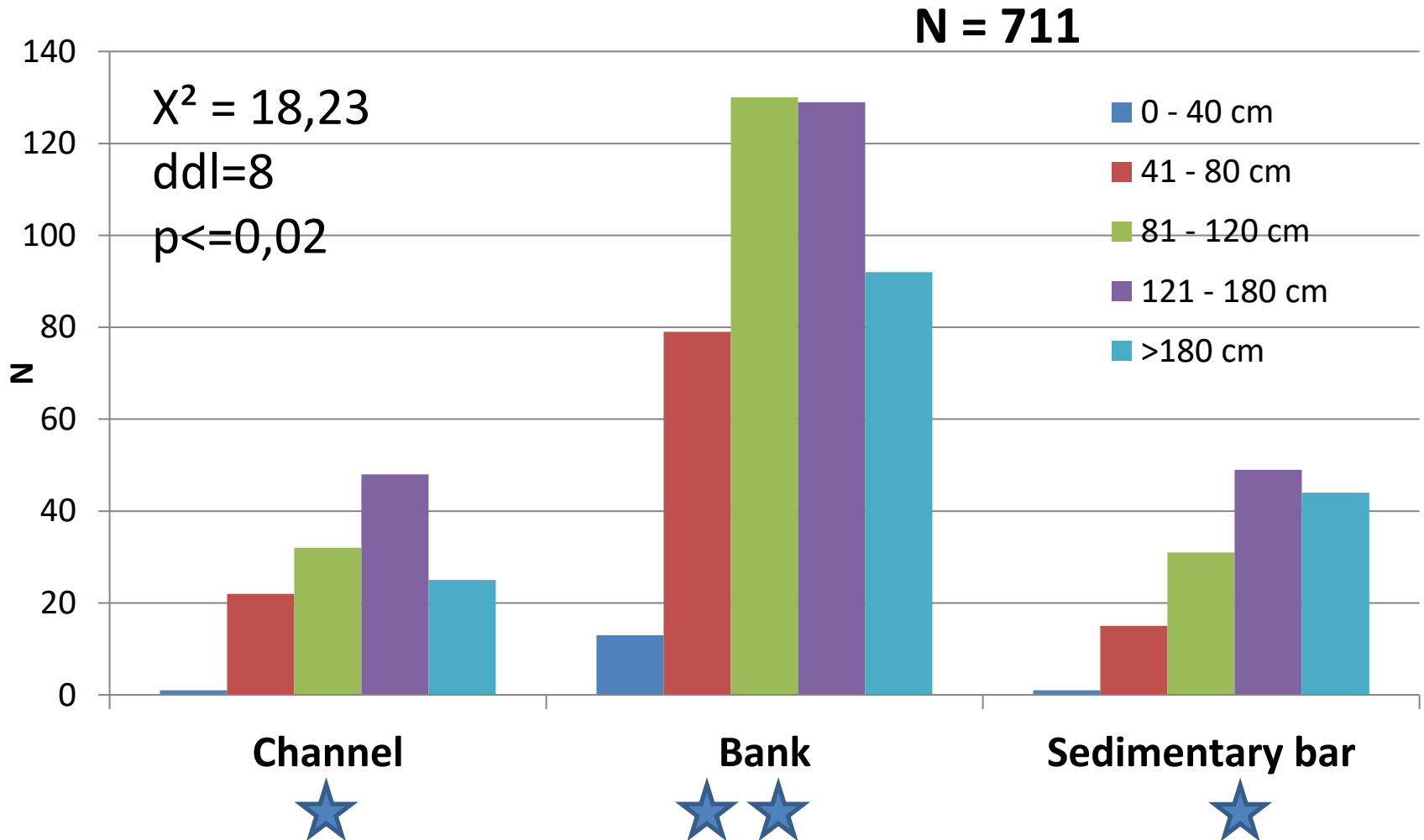

Density

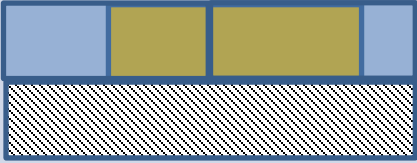
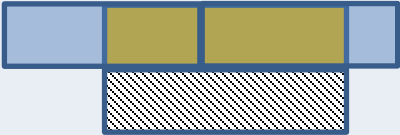
	The fish are moving Selected workforce: maximum observed by one of the two techniques	Fish do not move Selected workforce: sum of individuals observed by both techniques
<p>Maximum length and maximum area sampled by both techniques</p> 	<p>19,5 ind/km 1,1 ind/ha</p>	<p>22,7 ind/km 1,3 ind/ha</p>
<p>Length and area sampled jointly by both techniques</p> 	<p>25,9 ind/km 1,3 ind/ha</p>	<p>31,1 ind/km 1,5 ind/ha</p>

Summary

- Identification of the shooting conditions for the drone
- Feasibility of underwater counts in wood pile
- Difficulties in automatically analyzing photos, videos should be better
- $19.5 \text{ ind / km} < \text{catfish density} < 31.1 \text{ ind / km}$
($> H_0$)

Next step

Estimate predation pressure

- Distribution into size classes
- Density
- Stomach content (biomass)
- Daily / seasonal consumption
- Consumption patterns and models

Acknowledgements

Drone contrast, the free divers from Amboise,
Chinon, Tours NAP, A Proust, Ph Boisneau.

catherine.boisneau@univ-tours.fr



ALOSA 2016-17