



DYNCOMP' 2015

International Conference on Dynamics of Composite Structures

June 2-4, 2015. Arles, France

MODELING AND IDENTIFICATION OF A CLASS OF HYPERVISCOELASTIC MATERIAL BEHAVIOR

**Tayeb Adel^{1,2}, Arfaoui Makrem¹, Zine Abdelmalek², Hamdi Adel¹,
Benabdallah Jalel¹ and Ichchou Mohamed²**

**¹Laboratoire de Mécanique appliquée et Ingénierie
Université de Tunis ElManar, Tunis, TUNISIE**

**²Laboratoire de Tribologie et Dynamique des Systèmes
Université de Lyon, Lyon, FRANCE**

- 1. Context**
- 2. Formulation of hyper viscoelastic model at finite strain**
- 3. Identification procedure**
 - 3.1 Identification of hyperelastic potential and relaxation module**
 - 3.2 Identification of reduced time function**
- 4. Conclusion & perspectives**

Industrial context

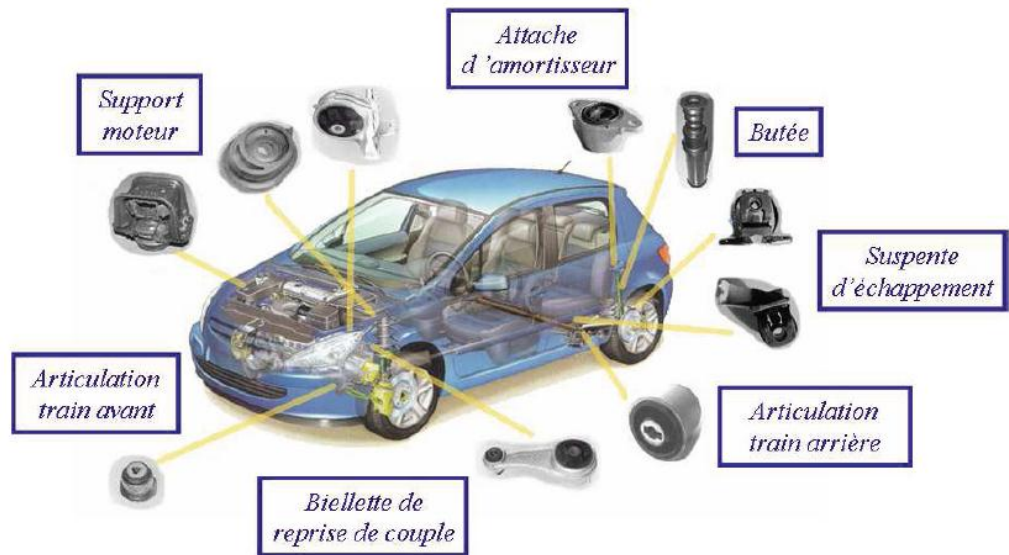

Scientific context

High deformability

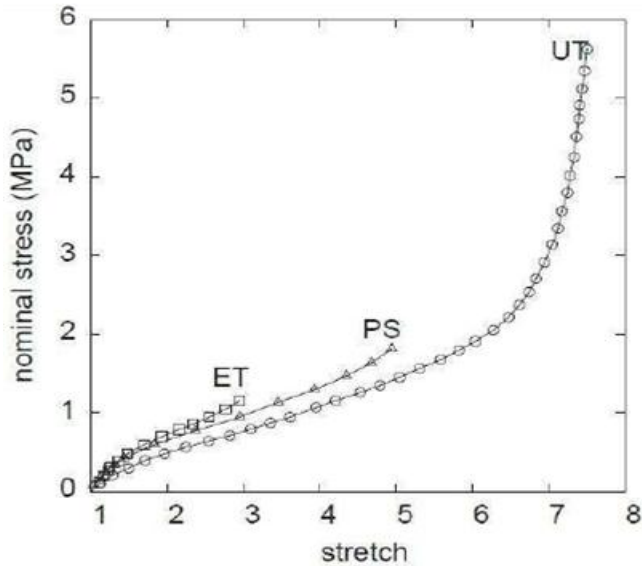

viscosity

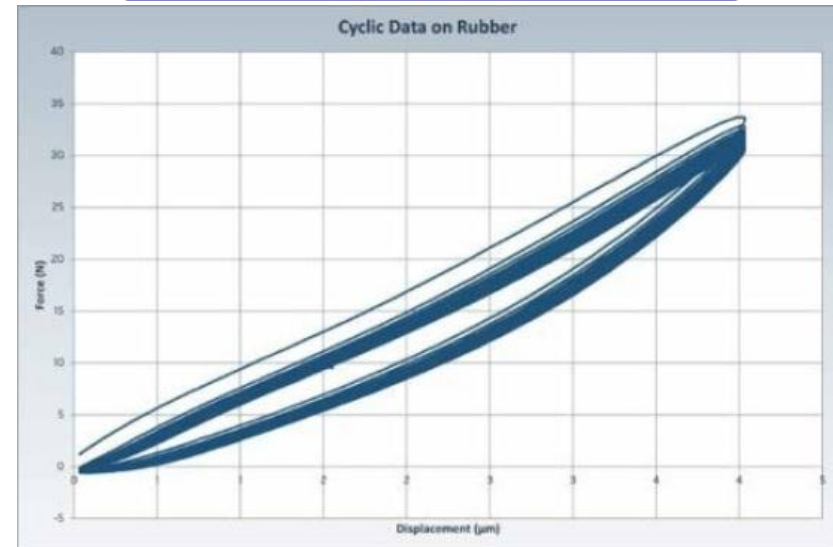

Payne effect

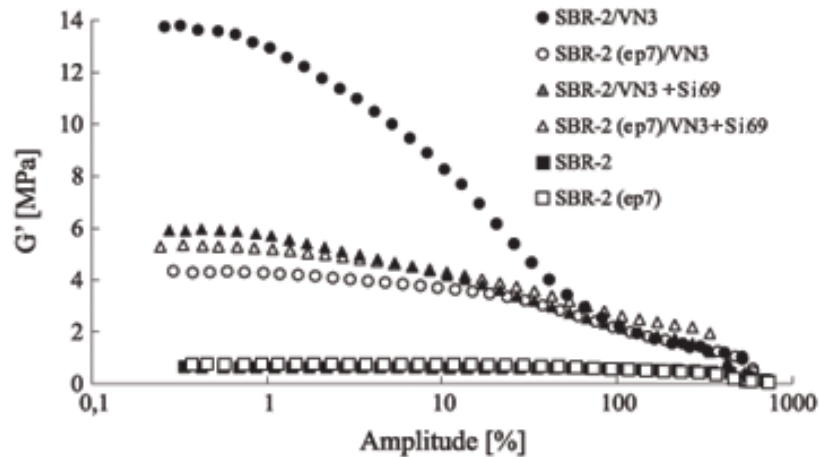

Mullins effect

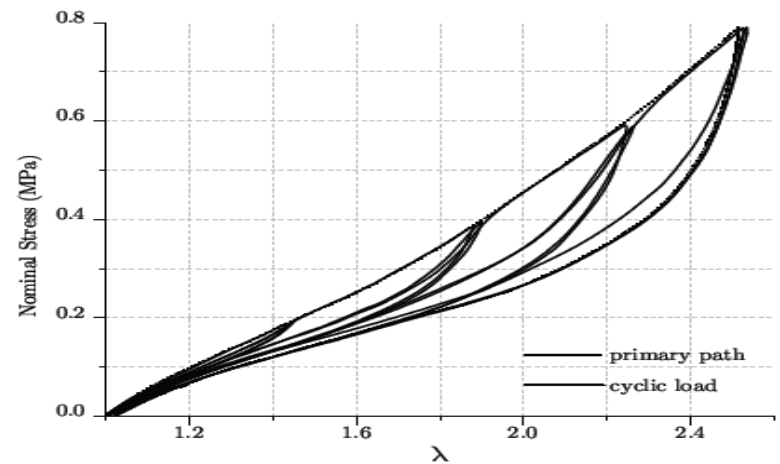

Hyperviscoelastic model

First approach
explicit relation between stress,
strain and temperature :
functional approach



Second approach
implicit relation between stress,
strain and temperature :
internal variables approach

Enrichment :
Introduction of a reduced
time function : strain shift
function

Viscoelastic behaviour law
at finite strain

Rheological model

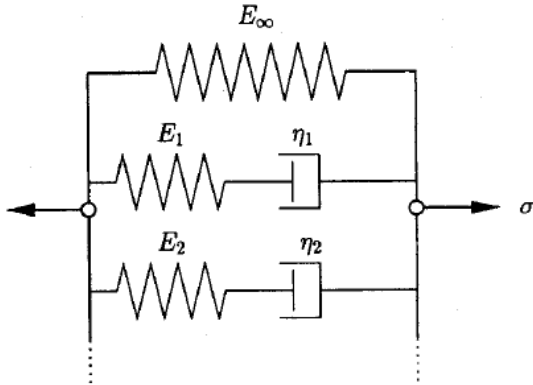

$$\dot{Q}^i + \frac{1}{\tau_i(\varepsilon)} Q^i = \frac{1}{\tau_i(\varepsilon)} \gamma_i \frac{\partial \Psi^o}{\partial \varepsilon}$$

$$\gamma_i = \frac{E_i}{E_0}; \Psi^o = \frac{1}{2} \varepsilon E_0 \varepsilon; E_0 = E_\infty + \sum_i E_i$$

Extending of the model at finite strain domain

form of the free energy density: $\Psi = \Psi^o(\underline{\underline{C}}) - \underline{\underline{Q}}^i : \underline{\underline{C}} + \frac{1}{4\mu_o(1-\gamma_i)} \underline{\underline{Q}}^i : \underline{\underline{Q}}^i$

evolution law of the internal variable: $\underline{\underline{\dot{Q}}}^i + \frac{1}{\tau_i(\underline{\underline{C}})} \underline{\underline{Q}}^i = 2 \frac{\gamma_i}{\tau_i(\underline{\underline{C}})} \left[\frac{\partial \Psi^o(\underline{\underline{C}})}{\partial \underline{\underline{C}}} \right]$

Hyperviscoelastic model

Expression of Cauchy stress tensor

$$\underline{\underline{\sigma}}(t) = 2\underline{\underline{F}}(\xi) \frac{\partial \Psi^o(\underline{\underline{C}})}{\partial \underline{\underline{C}}} \underline{\underline{F}}^t(\xi) + \underline{\underline{F}}(\xi) \int_0^\xi \frac{\partial G(\xi - \xi')}{\partial \xi'} \left(2 \frac{\partial \Psi^o(\underline{\underline{C}})}{\partial \underline{\underline{C}}} \right) d\xi' \underline{\underline{F}}^t(\xi) - p \underline{\underline{I}}$$

$$2\underline{\underline{F}}(\xi) \frac{\partial \Psi^o(\underline{\underline{C}})}{\partial \underline{\underline{C}}} \underline{\underline{F}}^t(\xi): \text{instantaneous stress}$$

$G(\xi)$: shear relaxation function

p : Lagrange multiplier due to incompressibility

$\underline{\underline{F}}(\xi)$: transformation gradient tensor

Reduced time function

$$\xi(t) = \int_0^t a(\underline{\underline{C}}(t')) dt'$$

- ❑ Similar formulation to the model implemented in Abaqus
(implementation simplicity)
- ❑ Simplicity of the identification of relaxation function and free energy density
- ❑ Covers linear and nonlinear viscoelastic models
- ❑ Only difficulty: the identification of reduced time function

Identification methodology

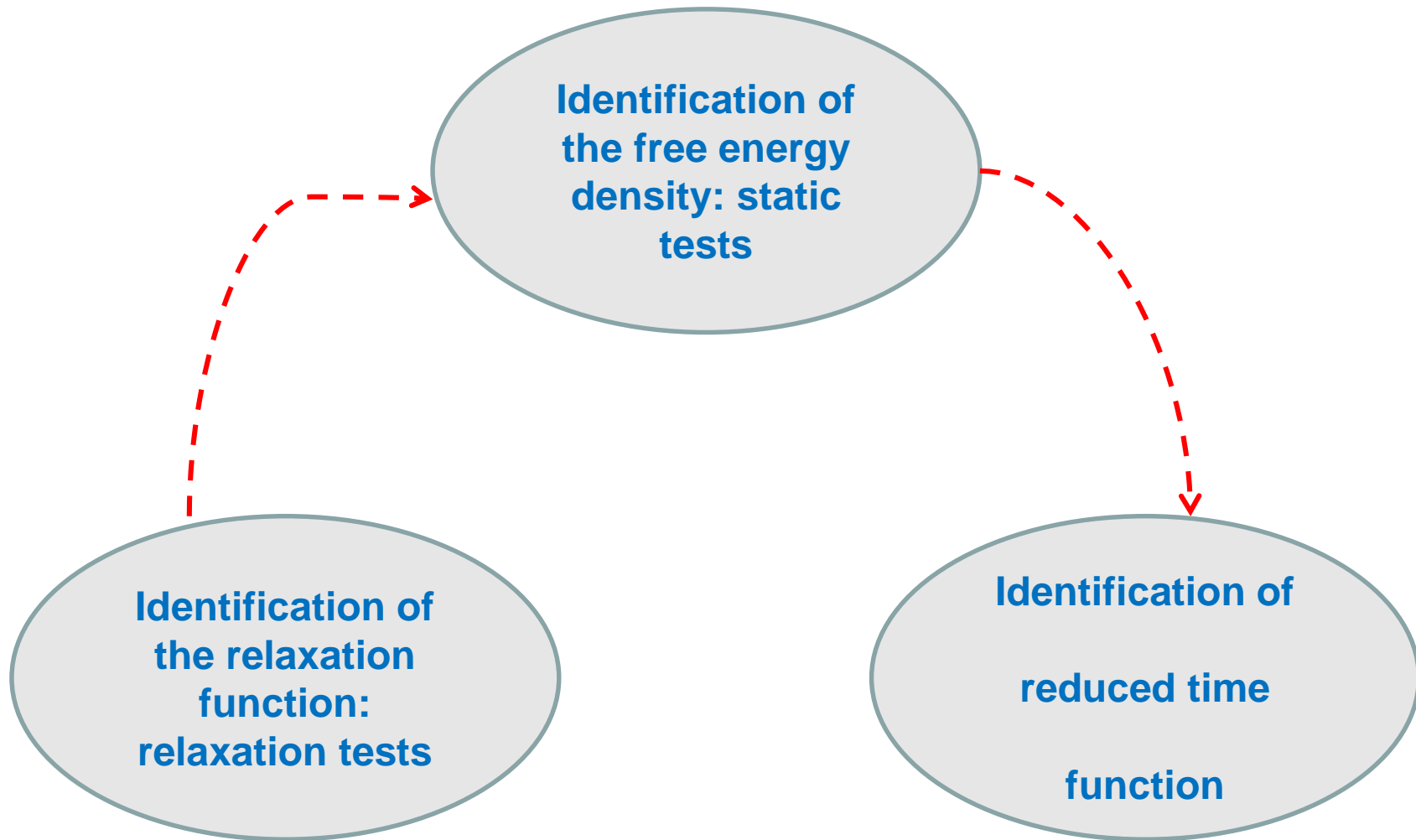

Free energy density

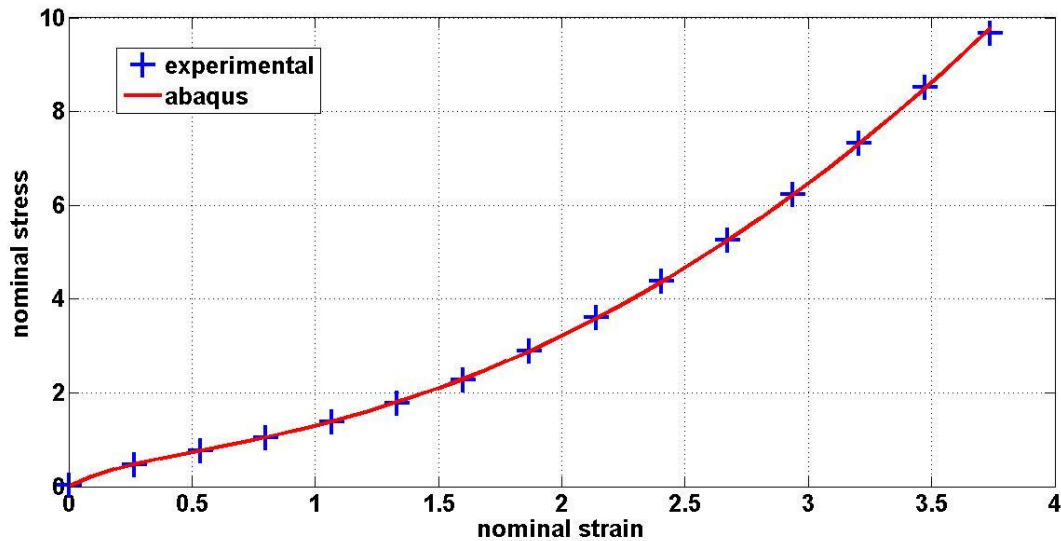
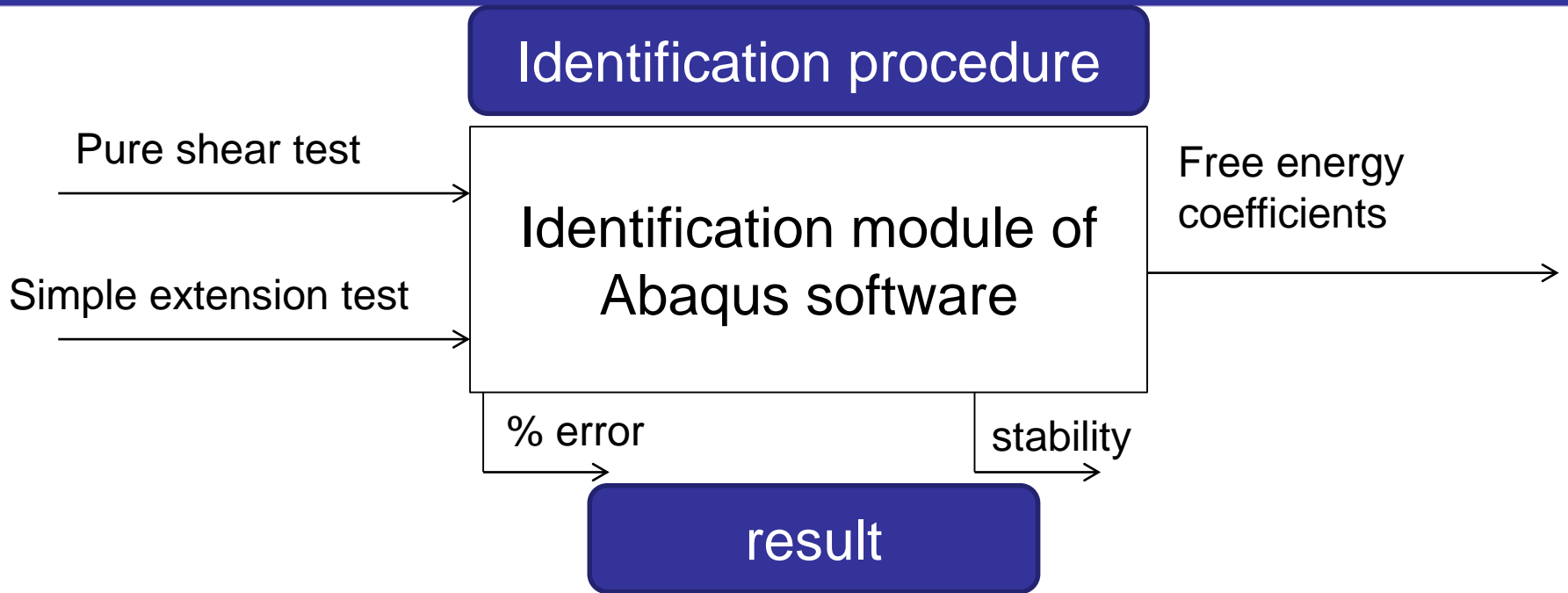

Relaxation function

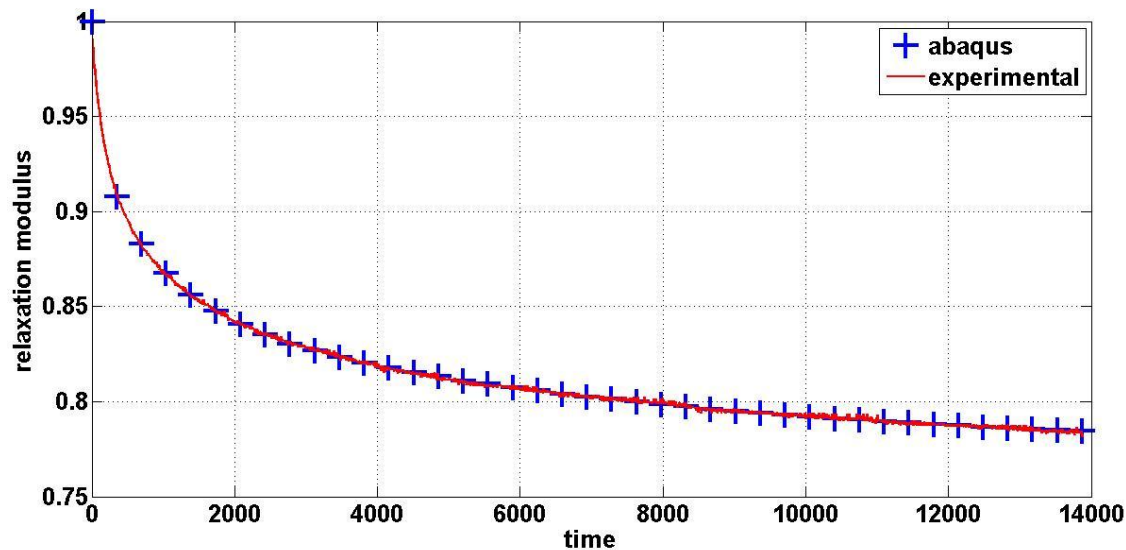
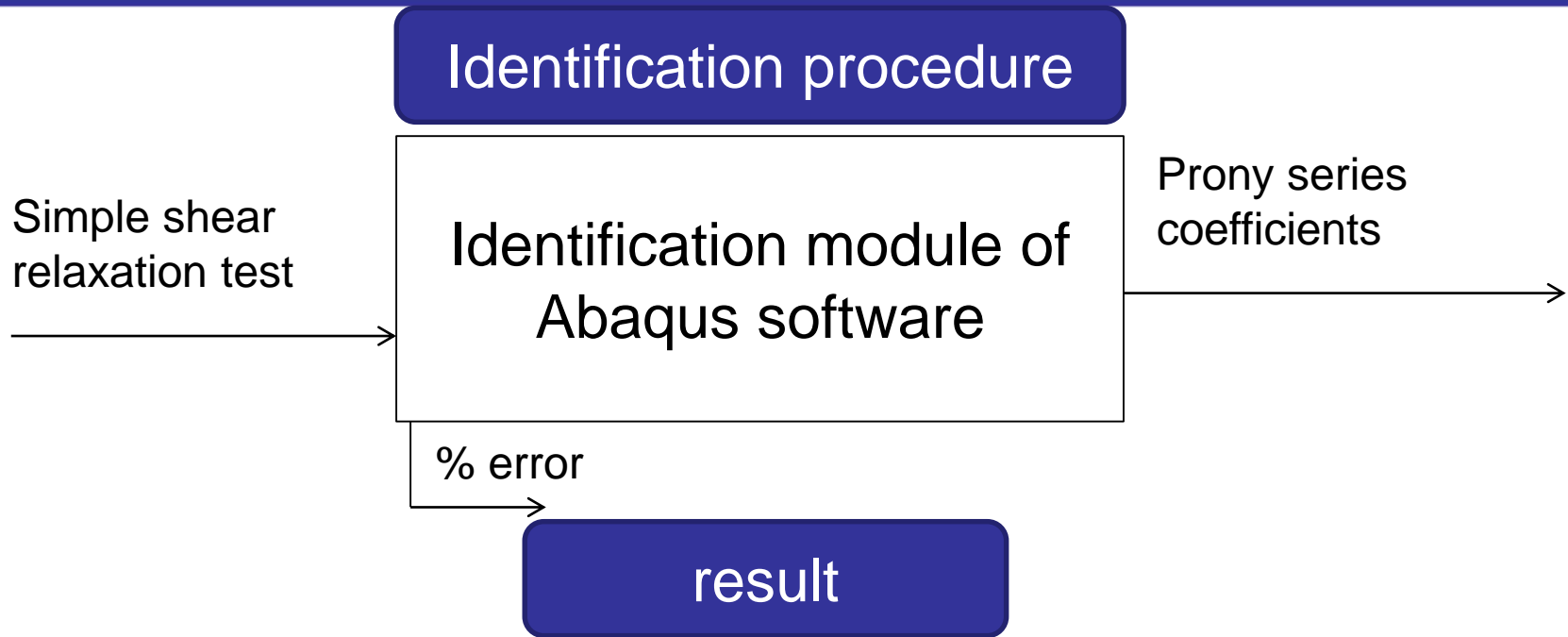

Identification of reduced time function

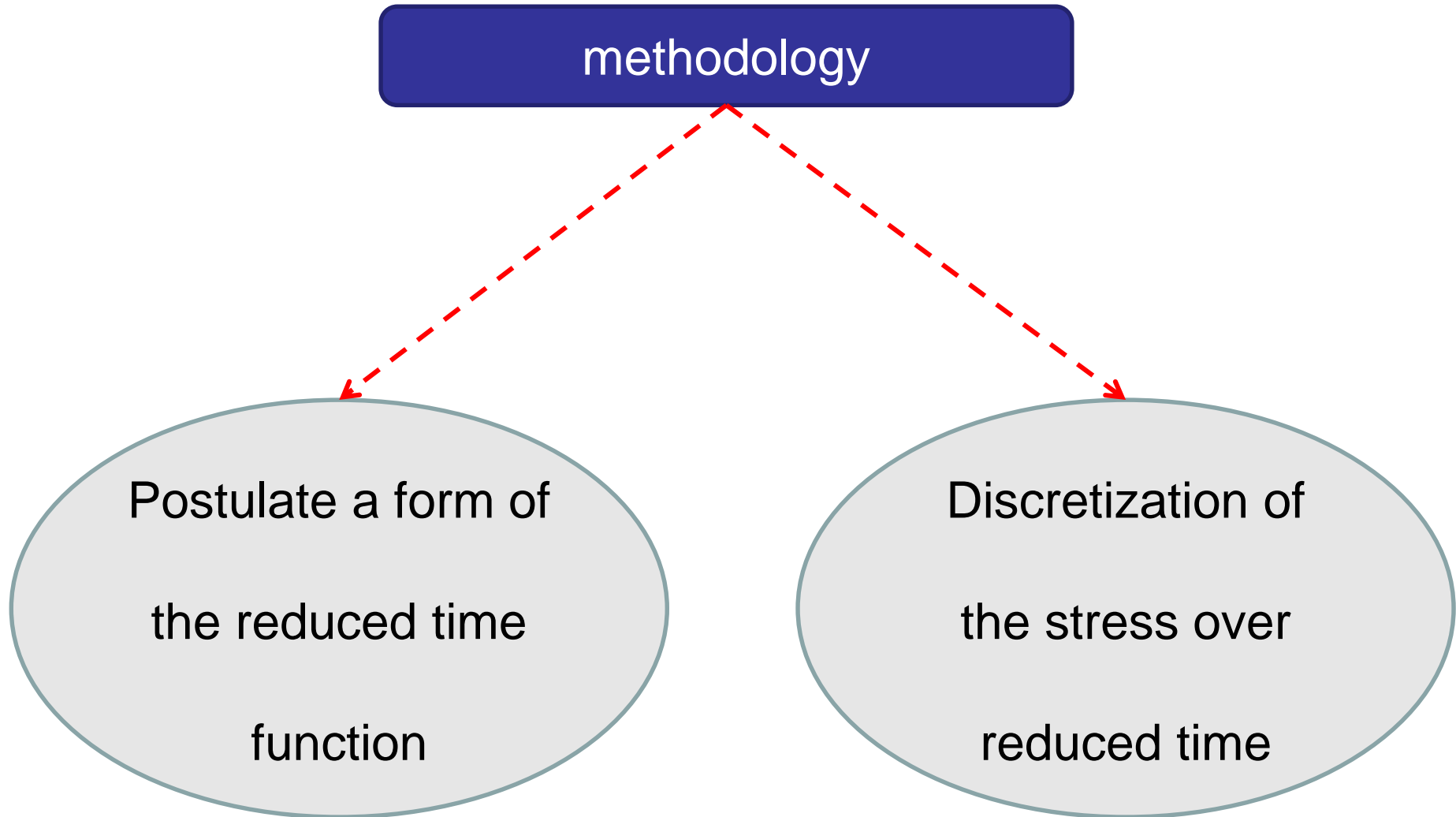

Identification of reduced time function: first approach

Form of the reduced time function

$$\xi(t) = \int_0^t c_1 (I_1(t') - 3) + c_2 (I_2(t') - 3) dt'$$

Absolute error of the stress

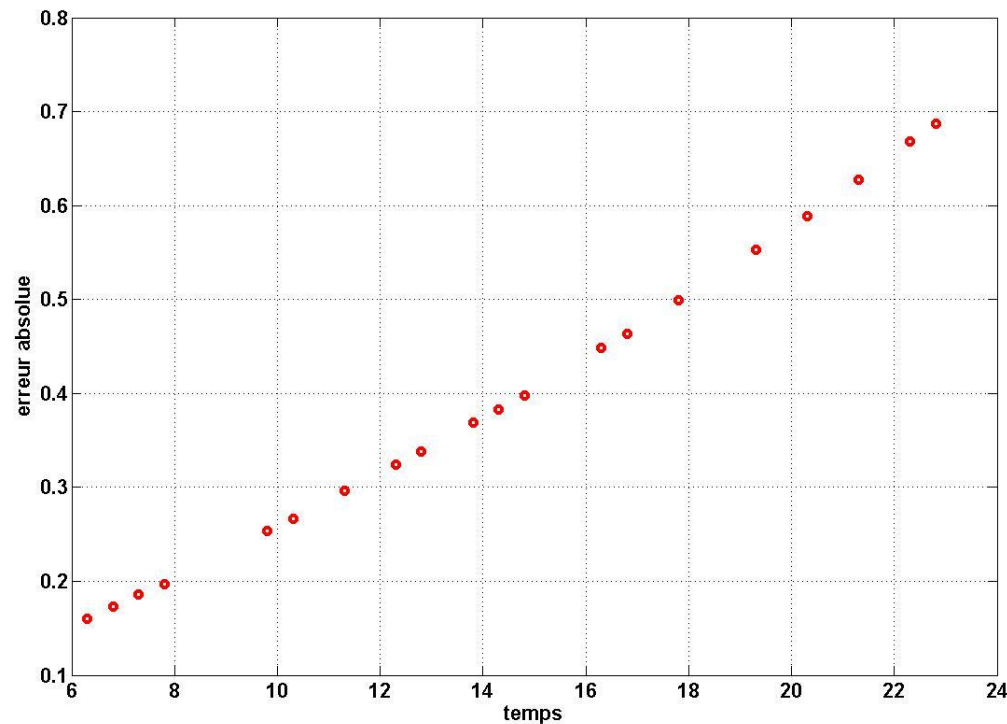

Error expression

$$E(\xi_0) = \left| \sigma(\xi_0) - \sigma^{\text{exp}}(\xi_0) \right|$$

$$E(\xi_{n+1}) = \left| \sigma(\xi_{n+1}) - \sigma^{\text{exp}}(\xi_{n+1}) \right| + E(\xi_n)$$

E : stress error function

σ^{exp} : experimental stress



Necessity of the discretization of the stress over reduced time

Discretization formula

$$\underline{\underline{\sigma}}(\xi_{n+1}) = \underline{\underline{\sigma}}_0^D(\xi_{n+1}) + \sum_{i=1}^N \underline{\underline{\sigma}}_i^D(\xi_{n+1}) - p \underline{\underline{I}}$$

$$\underline{\underline{\sigma}}_i^D(\xi) = \frac{g_i}{\tau_i} \int_0^\xi \underline{\underline{F}}_{\xi}^{-1}(\xi - \xi') \underline{\underline{\sigma}}_0^D(\xi - \xi') \underline{\underline{F}}_{\xi}^{-T}(\xi - \xi') \exp\left(-\frac{\xi'}{\tau_i}\right) d\xi'$$

$$\underline{\underline{\sigma}}_i^D(\xi_{n+1}) = \alpha_i g_i \underline{\underline{\sigma}}_0^D(\xi_{n+1}) + \beta_i g_i \hat{\underline{\underline{\sigma}}}_0^D(\xi_n) + \gamma_i \hat{\underline{\underline{\sigma}}}_i^D(\xi_n)$$

with

$$\gamma_i = \exp\left(-\frac{\Delta\xi}{\tau_i}\right); \alpha_i = 1 - \frac{\tau_i}{\Delta\xi}(1 - \gamma_i); \beta_i = \frac{\tau_i}{\Delta\xi}(1 - \gamma_i) - \gamma_i$$

$$\hat{\underline{\underline{\sigma}}}_i^D(\xi) = \underline{\underline{F}}_{\xi}(\xi + \Delta\xi) \underline{\underline{\sigma}}_i^D(\xi) \underline{\underline{F}}_{\xi}^T(\xi + \Delta\xi)$$

Validation of the discretization formula

- Geometry: VER
- Material: hyper viscoelastic material of Mooney-Rivlin
- Loadings :
 - Simple extension:
 - Relaxation :
 - Sinusoidal loading:

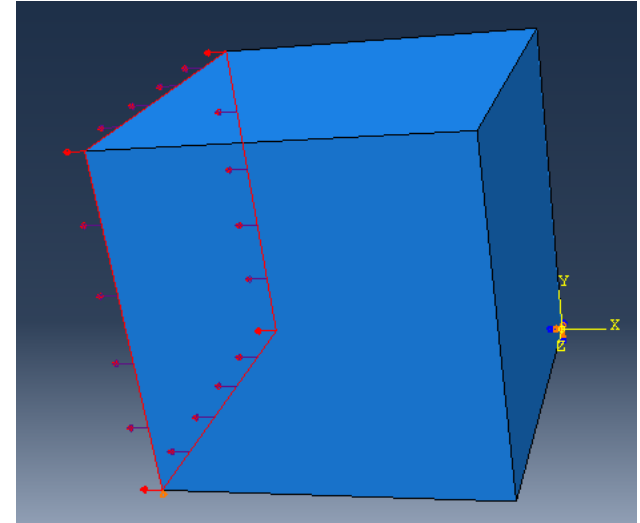

$$\lambda(t) = 1 + at$$

$$\lambda(t) = cste > 1$$

$$\lambda(t) = 1 + a \sin(\omega t)$$

Identification of reduced time function: second approach

relaxation

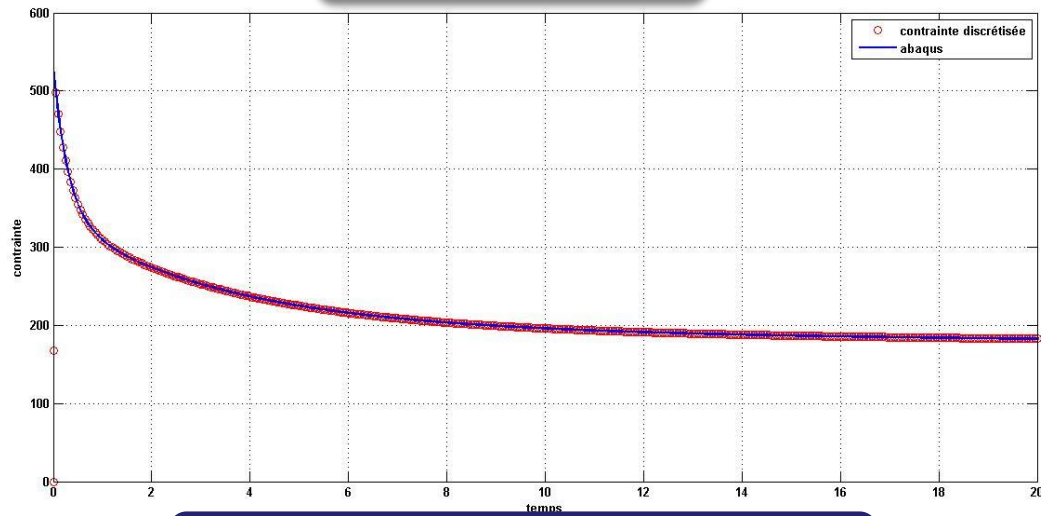

Simple extension

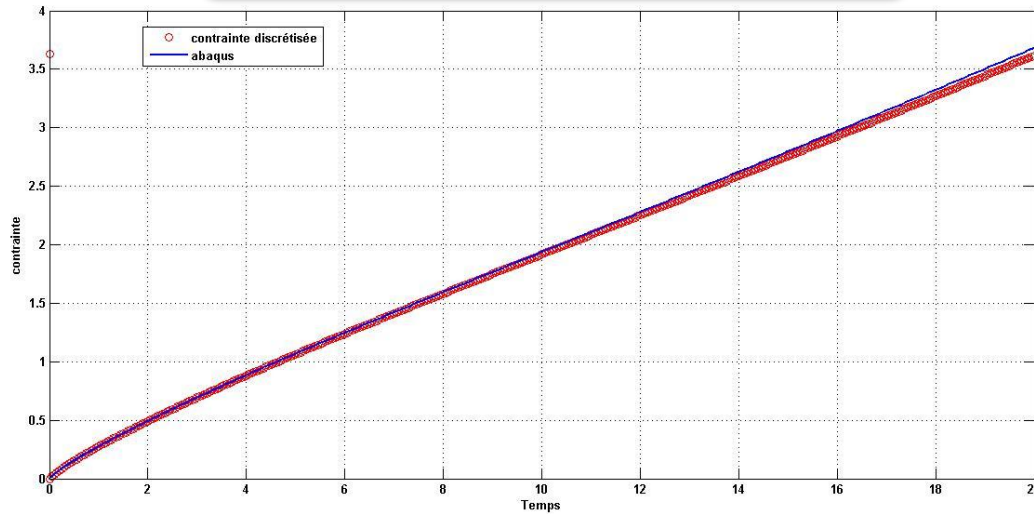

Sinusoidal loading

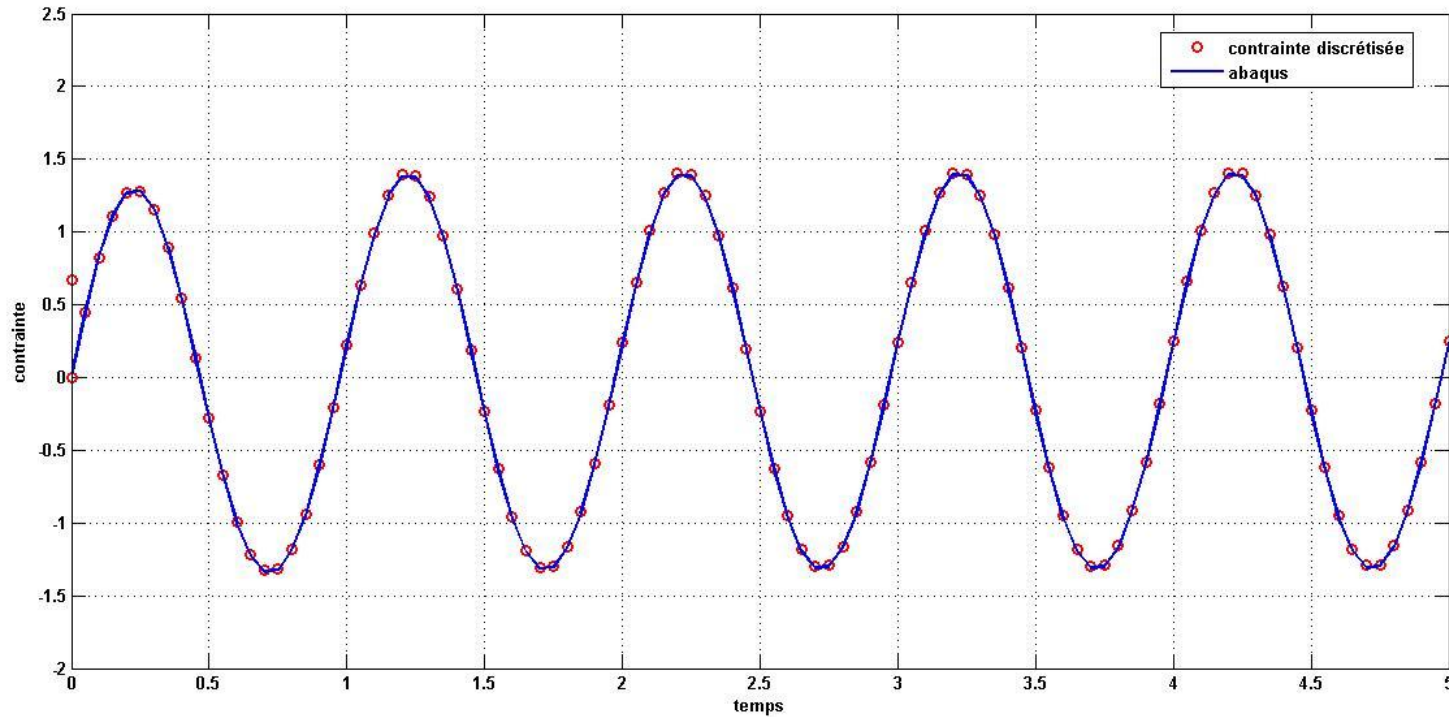

- ❑ Development of an hyperviscoelastic model using a combined approach (internal variables and functional approach)
- ❑ Development of the identification procedure
- ❑ Finalize the identification and validate the model for dynamic and static loadings