



HAL
open science

Environmental assessment of urine, black and grey water separation for resource recovery in a new district compared to centralized wastewater resources recovery plant

Mathilde Besson, Sylvaine Berger, Ligia Tiruta-Barna, Etienne Paul, Mathieu Spérandio

► To cite this version:

Mathilde Besson, Sylvaine Berger, Ligia Tiruta-Barna, Etienne Paul, Mathieu Spérandio. Environmental assessment of urine, black and grey water separation for resource recovery in a new district compared to centralized wastewater resources recovery plant. *Journal of Cleaner Production*, 2021, 301, 10.1016/j.jclepro.2021.126868 . hal-03340311

HAL Id: hal-03340311

<https://hal.science/hal-03340311v1>

Submitted on 10 Sep 2021

HAL is a multi-disciplinary open access archive for the deposit and dissemination of scientific research documents, whether they are published or not. The documents may come from teaching and research institutions in France or abroad, or from public or private research centers.

L'archive ouverte pluridisciplinaire **HAL**, est destinée au dépôt et à la diffusion de documents scientifiques de niveau recherche, publiés ou non, émanant des établissements d'enseignement et de recherche français ou étrangers, des laboratoires publics ou privés.

Environmental assessment of urine, black and grey water separation
for resource recovery in a new district compared to centralized
wastewater resources recovery plant

BESSON Mathilde^{1*}, BERGER sylvaine², TIRUTA-BARNA Ligia¹, PAUL Etienne¹, SPERANDIO Mathieu¹

¹TBI, Université de Toulouse, CNRS, INRAE, INSA, Toulouse, France - 135 avenue de Ranguel

31077 Toulouse CEDEX 04

²Solagro, France - 75 Voie du TOEC – CS 27608 – 31076 TOULOUSE Cedex 3

*Corresponding author: mbesson@insa-toulouse.fr +33 (0)5 61 55 97 55

Bâtiment 39, TBI, 135 avenue de Ranguel, 31077 Toulouse CEDEX 04, FRANCE

Type of paper: **Original article.**

Highlights

- Source separation scenarios were compared to centralized resource recovery facility
- Urine and black water separation reduce by 45 % and 34 % greenhouse gas emissions
- Nitrogen recovery can lead to neutral GHG emissions plant
- Greywater reuse increases climate change impact due to high energy consumption for MBR

Abstract

Current trends show that wastewater treatment plants (WWTPs) will intend to shift towards water resources recovery facility (WRRF), however nutrients recovery in WRRF is limited by the need of highly concentrated stream for the process. Source separation can help to increase this potential, but assessment is necessary to evaluate the whole system at district scale.

In this study three scenarios based respectively on urine diversion, blackwater and greywater separation were compared to the conventional end-of-pipe strategy with adjunction of treatment at the centralized WRRF for producing renewable fertilizers and energy. Life cycle assessment was used to compare environmental impacts. The study was performed to represent the implementation of a new district in an urban context. Treatments have been chosen among the best technologies available for resource recovery.

Results show that for maximizing nutrients recovery and limiting the greenhouse gas emissions, urine and blackwater separation are better scenarios than conventional mixing option and centralized WRRF. Indeed it allows to mitigate by at least 60 % the nitrous oxide (N₂O) emissions and to avoid nitrogen fertilizer production which emits large amount of greenhouse gases (8.6 kg CO₂-Eq/kgN). Urine source separation is particularly beneficial by recovering nitrogen at a low environmental footprint: impact on climate change decreases by 45 % compared to the Reference. The separation of blackwater treated at decentralized scale shows a decrease of 34 % of impact on climate change compared to *Reference*, thus a little worse than *Urine* due to a higher external energy demand at decentralized scale for nitrogen recovery. Phosphorus can be recovered in all the source separation system without additional climate change impact.

If the priority is given at water reclamation the treatment of blackwater and greywater separately is a valuable option. However energy balance and greenhouse gases emissions analysis do not support this scenario if highly energy consuming technology is used for greywater treatment (more than 0.56 kWh/m³ treated). It would become acceptable in case of decarbonized energy or if tap water production is a high greenhouse gases emitter.

Keywords

Source separation, wastewater treatment, resource recovery, life cycle assessment, urine, blackwater

32 **Graphical abstract**

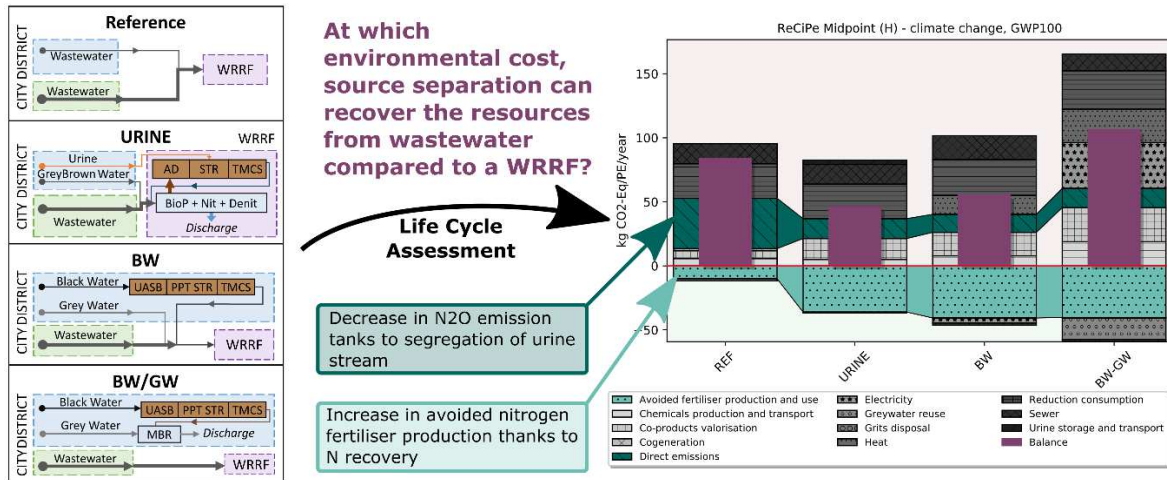

35 **Abbreviations**

- 36 BOD₅: Biological oxygen demand at 5 days
- 37 BW: Scenario with blackwater separation and treatment in the district, greywater is sent to the WRRF
- 38 BW-GW: Scenario with blackwater and greywater separation and with a decentralized treatment
- 39 COD: Chemical oxygen demand
- 40 GHG: Greenhouse gases
- 41 LCA: Life Cycle Assessment
- 42 TN: Total nitrogen
- 43 TP: Total phosphorus
- 44 U: Urine
- 45 WRRF: Water resources recovery facility
- 46 WWTP: Wastewater treatment plant

47

48 1. Introduction

1
2
3 49 Current trends show that wastewater treatment plants (WWTPs) will intend to shift towards Water
4 50 Resources Recovery Facility (WRRF), with the aim, not only to preserve water bodies but also to
5
6 51 produce resources (Guest et al., 2009; Diaz-Elsayed, et al., 2019) such as water, energy and carbon,
7
8 52 phosphorus and nitrogen compounds. However the current processes can only be applied on highly
9
10 53 concentrated stream, conventionally nutrients are recovered from liquid portion of the anaerobically
11 54 digested sludge or directly from solid sludge or even sludge ash. The amount of nutrient recovery is thus
12 55 limited by the capture efficiency in primary and secondary sludge from waterline treatment.
13
14
15 56

16
17 57 In addition to improvements developed for WWTPs, several studies investigated the possibility of a
18 58 shift in sanitation systems, where wastewater can be segregated at the source (within households).
19
20 59 Indeed, a large proportion of pollutants (nutrients and organic matter) in wastewater comes from human
21 60 excreta (Larsen and Gujer, 1996). Although urine alone represents only 1% of the total effluent volume,
22 61 between 70 % and 80 % of total nitrogen and around 50 % of the phosphorus in wastewater come from
23 62 urine. Therefore, source separation would be efficient to concentrate the nutrients and hence avoid
24 63 downstream dilution and mixing with other molecules.
25
26
27
28
29

30 64 Two strategies have been tested in northern Europe: 1) projects with a urine source separation approach
31 65 (Larsen et al., 2013) and 2) projects with separation of blackwater at the source, i.e. effluent from
32 66 domestic toilets (Skambraks et al., 2017). As low volume is involved, urine can be collected by truck
33 67 and urine source separation aims to produce a fertilizer rich in nutrients. Blackwater separation is able
34 68 to recover the organic matter fraction from blackwater, which represents around 50 % of organic matter
35 69 coming from the wastewater. It allows energy production (via biogas produced from anaerobic
36 70 digestion) but also nutrients extraction in the following treatment steps. Moreover the greywater can be
37 71 reused for non-potable uses. This option of blackwater/greywater separation could be therefore a more
38 72 promising approach because the entire wastewater can be turned into a resource. In order to optimize
39 73 blackwater treatment through anaerobic digestion and avoid dilution with too large flush water, vacuum
40 74 collection would need to be implemented with vacuum toilet. High energy consumption of this
41 75 technology forces the treatment to be decentralized. Therefore source separation transforms the whole
42 76 wastewater management system with changes in the collection, treatment and valorization.
43
44
45
46
47
48
49
50
51
52
53
54

55 78 Several studies have already attempted to evaluate the efficiency and the environmental impact of
56 79 different resource recovery solutions by modelling and comparing them to conventional sanitation
57 80 systems thanks to life cycle assessment. It can be highlighted that the boundaries of these studies can
58
59
60
61
62
63
64
65

81 integrate different subsystems, such as potable water production, biowaste management, fertilizer
82 production and obviously waste water management, making the comparison difficult.

83 However the majority of the studies conclude that there is an environmental benefits of urine source
84 separation. Several keys point can be highlighted: 1) the nitrogen of urine must be recovered and
85 valorized as a fertilizer (Bisinella de Faria et al., 2015); 2) the spreading of urine or by-product is a
86 sensitive parameter to avoid emissions into air (Tidåker et al., 2007). Acidification is most of the time
87 increased by urine source separation due to higher emissions of NH₃ in the air (losses during storage
88 and spreading) and NO_x (transport of urine and urine collection equipment). Moreover urine source
89 separation scenarios considers most of the time a low water flush (0.05 L/flush) (Igos et al., 2017; Ishii
90 and Boyer, 2015; Landry and Boyer, 2016). This value is very unlikely for a large deployment, the toilet
91 paper is not trained enough, as it has been reported in real pilot project (Winker et al., 2013).

92
93 Regarding blackwater separation scenario, conclusion is less obvious and depends on 1) energy
94 consumption for vacuum sewer and 2) the choice of greywater treatment. Vacuum sewer energy
95 consumption varies from 8 kWh_{el}/m³ (Thibodeau et al., 2014b) to 15 kWh_{el}/m³ (Meinzinger et al., 2010)
96 which is similar to real case pilot projects. With the lowest value, energy balance can be positive but it
97 is not the case with the highest. Finally greywater treatment is also a key parameter which can switch
98 the conclusion. Indeed rustic treatment of greywater (septic tank and reed bed filter) allows to have a
99 positive energy balance (Thibodeau et al., 2014b) but not with high-tech processes as membrane
100 bioreactor (Remy, 2010). In this latter study, large amount of greywater need to be recycled to have an
101 environmental benefit.

102 Moreover, several parameters are less integrated, as for example the direct emissions from wastewater
103 treatment in the atmosphere and the emissions from spreading of by-product (Ishii and Boyer, 2015;
104 Landry and Boyer, 2016). Theses emissions have been proven to be a major contributor to environmental
105 impact (Bisinella de Faria et al., 2015) and cannot therefore be omitted.

106 The majority of these studies compare the alternative scenarios with a conventional wastewater
107 treatment plant without any resource recovery. The functions of those systems are thus not equivalent
108 which be in favor of source separation system where best technology available are applied. When plant
109 retrofitting is considered (Bisinella de Faria et al., 2015; Igos et al., 2017; Wilsenach and van
110 Loosdrecht, 2006), only the redesign of the treatment process for nitrogen removal and not nutrient
111 recovery is included.

112 Finally all of these studies implement source separation to a large extent in the city. Only one
113 investigates the implementation at the district scale (Kavvada et al., 2017) as it is the case in real pilot
114 projects. Only few studies analyze source separation at district scale for on-site sanitation (Mbaya et al.,

115 2017; Xue et al., 2016). Greywater treatment and reclamation has yet shown the importance to take into
1 116 account the scale and the different type of urbanism (Bonoli et al., 2019; Jeong et al., 2018) and the
2
3 117 same effect can be supposed in source separation scenarios. Therefore a tool capable of district scale
4
5 118 analysis is necessary.
6

7 119 To fulfil these gaps, this study aims to develop a methodology and a tool allowing the modelling and
8
9 120 comparison of different wastewater management options with resource recovery, in a new district. The
10
11 121 developed methodology and tool should enable evaluating to what extent source separation (blackwater,
12
13 122 urine, and greywater management) could help increasing the resource recovery and decreasing
14
15 123 environmental impacts of wastewater management for a new district compared to the system without
16
17 124 separation. It could identify the potential interest for shifting from centralized WRRF to a scenario of
18
19 125 source separation with better environmental performance. The tool is based on mass and energy balance
20
21 126 modelling of the involved processes, from collection to effluent discharge in the environment. For
22
23 127 illustrating the methodology and the tool capabilities, three scenarios representative of several pilot
24
25 128 projects already undertaken around Europe have been modelled and compared. The simulation results
26
27 129 are then used for Life Cycle Assessment (LCA) of the proposed scenarios and of the centralized WRRF
28
29 130 in order to compare their environmental performances.
30
31
32
33
34
35
36
37
38
39
40
41
42
43
44
45
46
47
48
49
50
51
52
53
54
55
56
57
58
59
60
61
62
63
64
65

2. Materials and methods

2.1 General methodology

The general methodology is composed of three steps:

1) The district typology and topography is generated according to the topologies identified by (Bonhomme et al., 2012). A geographic information system is used to associate the buildings and their characteristics (surface of floor, number of inhabitants and employees, height). Influent characteristics and transport requirements are then calculated and the decentralized technologies are defined.

2) Modelling of the different wastewater recovery facilities treating effluents from the new district and from the existing city. For this purpose, the SUMO[®] (Dynamita v19 2019) software is used with an integrated model based on an activated sludge and anaerobic model coupled to gas exchange.

3) LCA of the defined scenarios, based on data obtained from the first two steps. To this end, an automated link between the SUMO results (output) and LCA Umberto software (input) was used, previously implemented by (Bisinella de Faria et al., 2015).

The different steps of the modelling strategy provide an analysis with different boundaries. Results on mass and energy balance are analyzed at the level of the processes involved, from the effluent collection to the effluent treatment, while the LCA results are analyzed with extended boundaries to take into account the benefits provided by fertilizer production, water reused or energy production.

This study focuses on the new district, however, the new district is part of a city, where the number of inhabitants is larger than the new district. The impact of the new district needs to be highlighted. For this purpose the centralised WRRF treating the city effluent before the implementation of the new district has been modelled (*City* scenario). Then, the results obtained from the *City* are subtracted to the results of simulation of the whole system including the new district (Equation 1). In this sense, only the extra environmental costs of the district are taking into account.

$$Results_{District} = Results_{District+City} - Results_{City} \quad \text{Equation 1}$$

The methodology description follows the three steps cited above.

2.2 Generation of district data

2.2.1 District generation

A new district is considered, built in a city which is already equipped with a WRRF treating 56 003 PE with a flow rate of 12 900m³/d. The urban planning of the district is described as discontinuous blocks according to the work of (Bonhomme et al., 2012). With a surface of 6.25 ha this type of planning is composed in majority of collective buildings for residence purposes. Besides the 921 inhabitants, 469 external people are employed on site which together represents 697 PE to treat. The planning of the district is presented in Figure S 1 in SI. A flat topography has been considered in this study.

2.2.2 Studied scenarios

Three different source separation and one reference centralized scenarios are compared (Figure 1) with an increasing decentralized scale of treatment meaning that the treatments of wastewater are more and more located in the district and less in the centralized WRRF:

- i) the centralized WRRF scenario (*Reference*) where nitrogen and phosphorus recovery take place,
- ii) the urine source separation scenario (*Urine*) with treatment at the centralized WRRF,
- iii) the scenario of decentralized treatment of blackwater and centralized treatment of greywater in WRRF (*BW*),
- iv) the scenario of black and greywater source separation and their treatment in a decentralized system (*BW-GW*).

The three source separation scenarios are representative of several pilot projects already undertaken around Europe. Phosphorus recovery is performed through struvite precipitation in each scenario. Nitrogen recovery within separated waste effluents is the only treatment which has been added since it is not implemented in these projects. The choice of technology for nitrogen recovery has been based on two criteria: 1) the lowest energy consumption and 2) a demonstration of the process efficiency with at least pilot plant scale (see Table S 1 in supplementary information). Transmembrane chemisorption (TMCS) is currently one of the best emerging technologies for nitrogen recovery with its low energy consumption (2.55 kWh_{elec}/kgNH₄-N_{recovered} (Böhler et al., 2018) compared to 76 kWh_{elec}/kgN for nitrification/distillation (Udert and Jenni, 2013; Udert and Wächter, 2012) and 7.2 kWh_{elec}/kgN for ammonia stripping (Maurer et al., 2003)). It consists on hydrophobic membranes which allow ammonia gas to transfer to an acidic solution and form a nitrogen salt. This technology has been tested at pilot scale for urine treatment (Damtie et al., 2020; Zhang et al., 2013) but it is already installed at full scale in the WWTP of Altenrhein and Yverdon-les-Bains (Böhler et al., 2018) treating approximately 37 m³/day of rejected water from anaerobic digestion. Therefore relevant and realistic data are available for this study. More information on treatment is given in the following section 2.3.2.

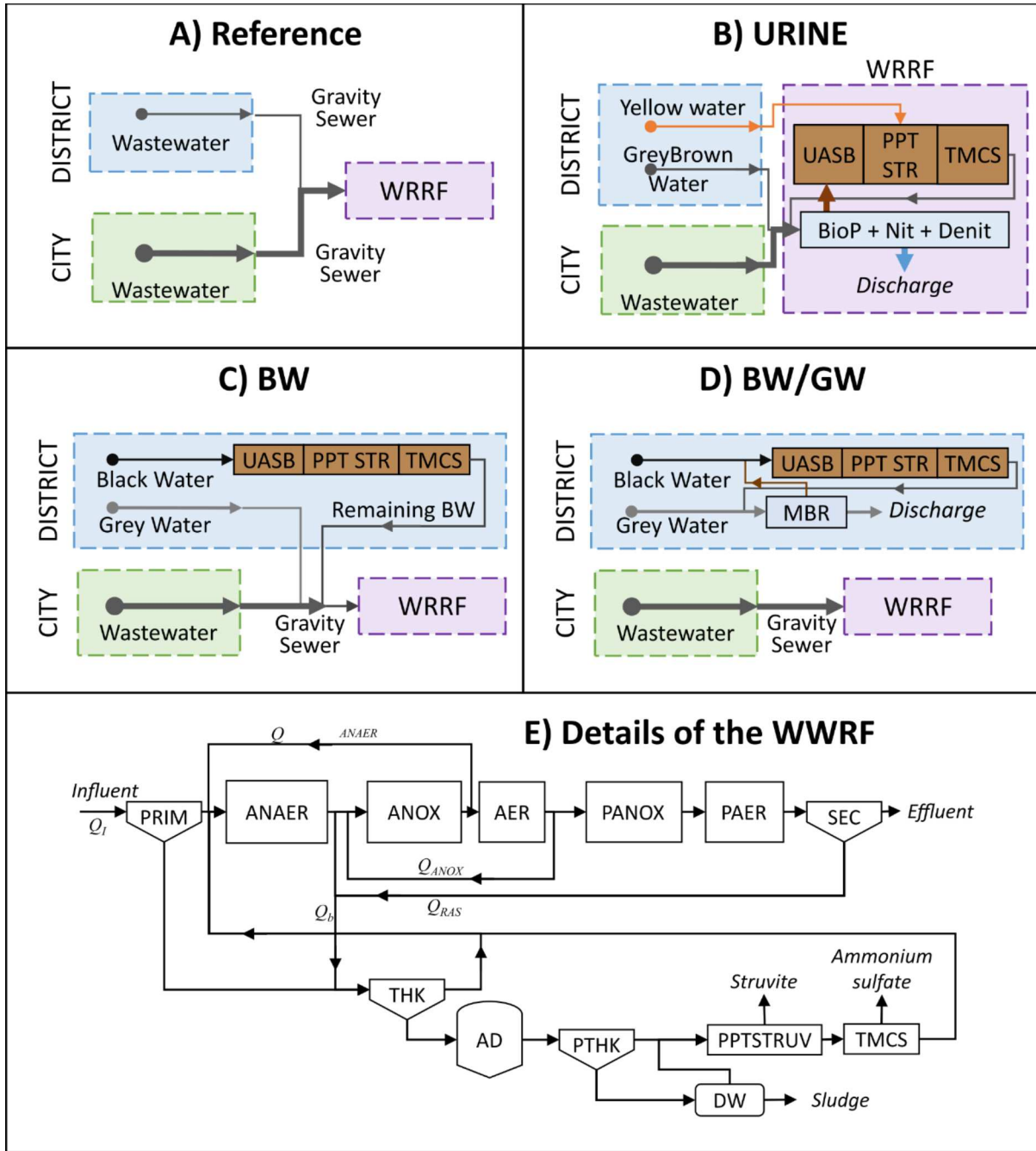

196 *Figure 1: Scheme of the four scenarios and of the WRRF. WRRF: Wastewater recovery facility, AD: Anaerobic digester,*
 197 *PPTSTRU: Struvite precipitation, TMCS: transmembrane chemisorption, UASB: upflow active sludge blanket, MBR:*
 198 *membrane bioreactor, ANAER: anaerobic tank, ANOX: anoxic tank, AER: aerated tank, PANOX: post-anoxic tank, PAER:*
 199 *post aerobic tank, THK: thickening, PTHK: post-thickening, DW: dewatering.*

200 In the *Reference* scenario, wastewater is collected with a gravity sewer line. The volume of flushed water
 201 is 3 L after urination and 6 L after defecation (Arocha and McCann, 2013).

202 In the *Urine* scenario, urine is collected in tanks and then transported once a week by truck (10m³ trucks,
 203 two rounds per week) to the WRRF. The remaining wastewater is transported as usual through the
 204 gravity sewer line. Considering 3 L or 6 L toilet flushes, it is considered that only 0.2 L of every flush

205 goes into the urine compartment and storage, while the remaining volume is flushed in the feces
 206 compartment. Only 80 % of urine is separated which corresponds to the best performances observed in
 207 pilot projects (data from (Jönsson et al., 1998) and (Peter-Fröhlich et al., 2007) respectively for
 208 Understenshöjden et Palsternackan projects in Sweden and SCST project in Germany). The remaining
 209 20 % is transported with feces. This urine recovery is influenced by the design of the toilet which allows
 210 more or less urine retention but also the willingness of the user to facilitate the separation. Indeed, urine
 211 separation toilet still requires gents to sit down when urinating.

212 In both *BW* and *BW-GW* scenarios, blackwater is collected through a vacuum toilet (1.2 L per flush,
 213 Evac Toilet (EVAC, n.d.)) followed by a vacuum sewer until reaching a vacuum station in the middle
 214 of the district where the treatment takes place. The greywater obtained in the *BW* scenario is sent to the
 215 WRRF through a gravity sewer line. In the *BW-GW* scenario, blackwater and greywater are treated in
 216 decentralized systems in the middle of the district.

217 The influent characteristics used for each scenario are presented in the Table 1 and are extracted from
 218 the literature review described in SI (Section 1.3).

219 *Table 1: Influent characteristics for each scenario (see Figure 1 for the definition of the flow)*

Scenario	All	Reference	Urine		BW and BW-GW			Unit
			Yellow water	Grey brown water	Black water	Grey water	Remaining BW	
Flow rate	12900	111.4	1.7	109.7	6.1	95.5	5.5	m ³ /d
COD	601	864	4154	814	7897	507	565	g COD/m ³
BOD₅	261	375	3143	333	2700	283	331	g O ₂ /m ³
TN	68	88	3546	36	1429	12	450	g N/m ³
NH_x	50	67	3331	18	1191	2	213	g N/m ³
TP	11.	14	304	10	184	5	40	g P/m ³
SPO₄	6	12	290	8	168	3	19	g P/m ³

220
 221 As explained in the general methodology in section 2.2, each scenario has been modelled at the city
 222 scale with both decentralized treatment and the modeling of the centralized WRRF. The results analysis
 223 allows to take into account only the impact of the new district by the subtraction with the result of the
 224 modeling of *City* scenario (Equation 1).

226
1
2
3
4
5
6
7
8
9
10
11
12
13
14
15
16
17
18
19
20
21
22
23
24
25
26
27
28
29
30
31
32
33
34
35
36
37
38
39
40
41
42
43
44
45
46
47
48
49
50
51
52
53
54
55
56
57
58
59
60
61
62
63
64
65

2.3 Modelling of wastewater management

2.3.1. Wastewater collection

Gravity sewer is designed to achieve the transport of the peak flow by choosing the appropriate couple diameter / slope of the pipe according to (BERLAND, 2014; Bourrier, 2008; Monfront, 2009; Okun et al., 2010). This couple needs to fulfill three self-cleansing conditions to avoid sedimentation in the pipes. Moreover, when depth is too high (assumed to be 4 meters in our model), a pumping station is placed and designed.

Vacuum sewer works with air transport instead of water transport as in gravity sewer. A lift in series allows to maintain the transport of the wastewater. The design rules of (Bowne et al., 1991; Islam, 2017; Roediger Vacuum, 2012; SQAE, 1994) have been followed with a minimum slope of 0.002 m/m and a maximum depth is 1.5m below surface. The pressure drop is calculated based on the recommendations of (Bowne et al., 1991; Islam, 2017; SQAE, 1994) for static pressure drop and of (Jinming and Jingxuan, 2006) for frictional pressure drop.

Urine transport by truck is optimized to minimize the total distance thank to an ant algorithm (Bullnheimer et al., 1999; Dorigo and Gambardella, 1997), to solve the vehicle routing problem. It has been assumed that urine is stored for one week before collection by a 10 m³ truck and centralized at the WWRF, 10 km away.

More information can be found in supplementary information 1.1.

2.3.2. Decentralized treatments

In this section the decentralized treatments implemented in *BW* and *BW-GW* scenario are presented, more information about their design can be found in SI in section 1.2. For both, blackwater are digested in an upflow anaerobic sludge blanket (UASB) reactor which allows reaction and decantation to take place in the same unit. Bacteria are aggregated in granules and flocs and are maintained within the reactor by balancing the settling velocity and the upflow velocity of the liquid.

This reactor has been successfully applied by (de Graaff et al., 2010) when treating blackwater at ambient temperature and with a SRT of 75 days. A production of methane between 54 % and 60 % of the blackwater COD have been respectively reported by (de Graaff et al., 2010) and (Tervahauta et al., 2014) studies. The higher value has been chosen in this study.

After digestion, the effluent is processed for P and N recovery through struvite precipitation and transmembrane chemo-sorption (TMCS). (de Graaff and van Hell, 2014) chose a molar ratio of 1.5 Mg/P to precipitate the P with struvite, leading to the removal of 86 % phosphate and 4 % for other phosphorus compounds. In the TMCS process only the gas form of ammonia can transfer through the

260 pores. Thus both pH and temperature values have to be controlled. However, optimal values of pH and
261 temperature are still not defined and such topics need to be more intensively investigated. In this study,
262 applying a pH of 9.6 and a temperature of 45 °C allows to obtain 88.5 % of ammonia. To achieve such
263 alkaline pH values, caustic soda is injected before the membrane separation. 90 % of ammonia is
264 assumed to be removed in the TMCS module. A heating system is required to increase the temperature
265 from the operational temperature of UASB (25°C) to 45°C.

266 Greywater produced in the *BW-GW* scenario, is also treated in a decentralized system, by using a
267 membrane bioreactor (MBR). Aeration is used to prevent membrane clogging which involves a higher
268 energy consumption compared to conventional activated sludge treatment systems. However, membrane
269 separation, although being energy intensive, offers a better quality and stability of output effluents as
270 stated in literature (Winward et al., 2008). Water recovery hence seems very promising with this
271 technology whether applied on small or large scales. In this present study, the MBR is designed to
272 perform biological removal of phosphorus and denitrification. The effluent of blackwater treatment is
273 sent to the MBR with a mass flow of nitrogen. The sludge obtained through the MBR is also sent to the
274 digester for mineralization and the out coming phosphorus can then be captured with struvite
275 precipitation.

277 2.3.3. Modelling the centralized WRRF

278 As previously described, the advanced WRRF (Figure 1) is designed to recover as much as possible of
279 nutrients and organic matter. WRRF is based on biological removal of phosphorus coupled to sludge
280 digestion and struvite precipitation of digested sludge. Magnesium is added with a constant ratio
281 between magnesium added and to total phosphorus in entrance.

282 Nitrogen will also be recovered after precipitation by using the TMCS with the same operating
283 conditions than at decentralized scale: pH of 9.6 and a temperature of 45 °C. Moreover, to prevent
284 fouling of the membrane, solid separation is needed. Pre-treatment is modelled by considering a
285 retention of 100 % of the solids.

286 In case of urine separation, the collected urine is added to the output effluent of the digester to undergo
287 struvite precipitation and TMCS filtration. In the *BW* scenario, both greywater produced and the effluent
288 obtained after blackwater treatment, are both mixed with the city sewage in the main sewer line.

289 The same discharge regulations have been applied to each scenario fixed at 10 mgN/L and 1 mgP/L.
290 Even if regulation standards could allow higher concentrations in *BW-GW* scenario, due to the small
291 load to treat, the purpose of this study is not to increase the release of nutrients. The risk of eutrophication
292 is therefore maintained at the same level for all scenarios.

293 To achieve these standards, controls in the process are performed by using the SUMO software. The
294 two recirculation flowrates, r_{ANOX} and r_{ANAER} , are proportional to the influent flowrate entering the
295 primary decanter. Methanol flow is controlled to achieve the 10 mg TN/L (total nitrogen) by improving
296 the post-denitrification efficiency. Iron chloride is added to respect 1 mg TP/L (total phosphorus) for
297 the chemical removal of phosphorus. Finally, magnesium is added for struvite precipitation according
298 to a fixed ratio of 1.49 mol Mg / mol TP_{in}.

2.4 Life cycle assessment

299
300
301 LCA is the third step of the methodology and was applied following its four steps (ISO 14040-14044):
302 1) goal and scope definition, 2) life cycle inventory (LCI) building, 3) life cycle impact assessment
303 (LCIA), and 4) results interpretation.

2.4.1 Goal and scope

304
305 The goal of LCA study is to assess and compare several sanitation systems for a new district which aims
306 firstly to protect the receiving environment from eutrophication and secondly to maximize the resource
307 recovery.

308 The function of the system can be defined as “*collect and treat wastewater produced in the district while*
309 *respecting the discharge limit of 10 mg-N/L and 1 mg-P/L, and this for one year*”. The functional unit
310 is thus 1PE considering the EU normalized definition: 1 PE = 60 gDBO₅/d.

311 The system boundaries (Figure 2) includes the collection and treatment of wastewater (foreground
312 processes) but also production and transport of chemicals, electricity and heat and infrastructure
313 (background processes). As the WRRF systems produce fertilizers and treated water in addition to above
314 defined function, avoided processes are taken into account for fertilizer and tap water production.

2.4.2 Life Cycle Inventory

315
316 The inventory has been built by using the mass and energy data obtained from the two previous steps:
317 simulation results of collection and transport at district scale and with centralized facilities (step 1),
318 simulation results of treatment processes (step 2).

319 The life cycle inventory framework follows the work of (Bisinella de Faria et al., 2015) with the
320 adjunction of effluent collection and transport in the foreground part of the life cycle system. Figure 2
321 presents the extended system boundaries of the LCA.

322 Regarding sewer infrastructure, the inventory takes into account the diesel used for excavation, pipe
323 production and transport (in PE for vacuum network and PVC in gravity network) and the material to
324 fill trenches (sand, gravel), the infrastructure for inspection is also integrated (manholes and inspection
325 chambers). The bitumen used for building the road is not taken into account as it is allocated to road
326 creation (Petit-Boix et al., 2014). Regarding urine collection, storage tanks are assumed to be placed in

327 the district, one per building. The tanks are assumed to be in polyethylene (PE) with 40 years of lifespan,
328 and a mass of HDPE per tank volume of 28.412 kg/m³ is assumed (Ishii and Boyer, 2015).

329 Evaluation of the energy consumption within the WRRF is one of the most important task and follows
330 the work of (Bisinella de Faria et al., 2015) which takes into account: pumping of wastewater and
331 chemicals in the WRRF, mixing the non-aerated tank, energy for aeration, scraping sides of the decanter
332 and energy for dewatering and thickening the sludge. The energy consumption is also related to the heat
333 demand for digestion but also heat production through cogeneration. In this present study the energy
334 consumption of the TMCS was added in the inventory. Consumption of pumps are taken into account,
335 as well as the heat requirement in order to reach 45°C prior to ammonia stripping, which is supplied by
336 cogeneration or by a boiler if necessary. The energy consumption of TMCS is assumed to be
337 1.887 kWh/kgNH₄-N_{recovered} from data of the pilot plant of Yverdon-les-Bains in Switzerland (Böhler et
338 al., 2018) (CO₂ stripping and coagulation / flocculation pre-treatments and ventilation are excluded).

339 N₂O emissions from the biological treatment of wastewater are not incorporated in SUMO model. The
340 emissions factor from (IPCC, 2019) has been used: 1.6 % of the nitrogen entering the water line or
341 MBR. The remaining emissions into air, water or soil are the same as the ones used in (Bisinella de Faria
342 et al., 2015).

343 By-products (sludge, ammonium sulfate and struvite) are spread on agricultural land and can replace
344 part of nitrogen and phosphorus fertilizer considering the bio-availability of the components and the
345 post-spreading emissions from (Bisinella de Faria et al., 2015).

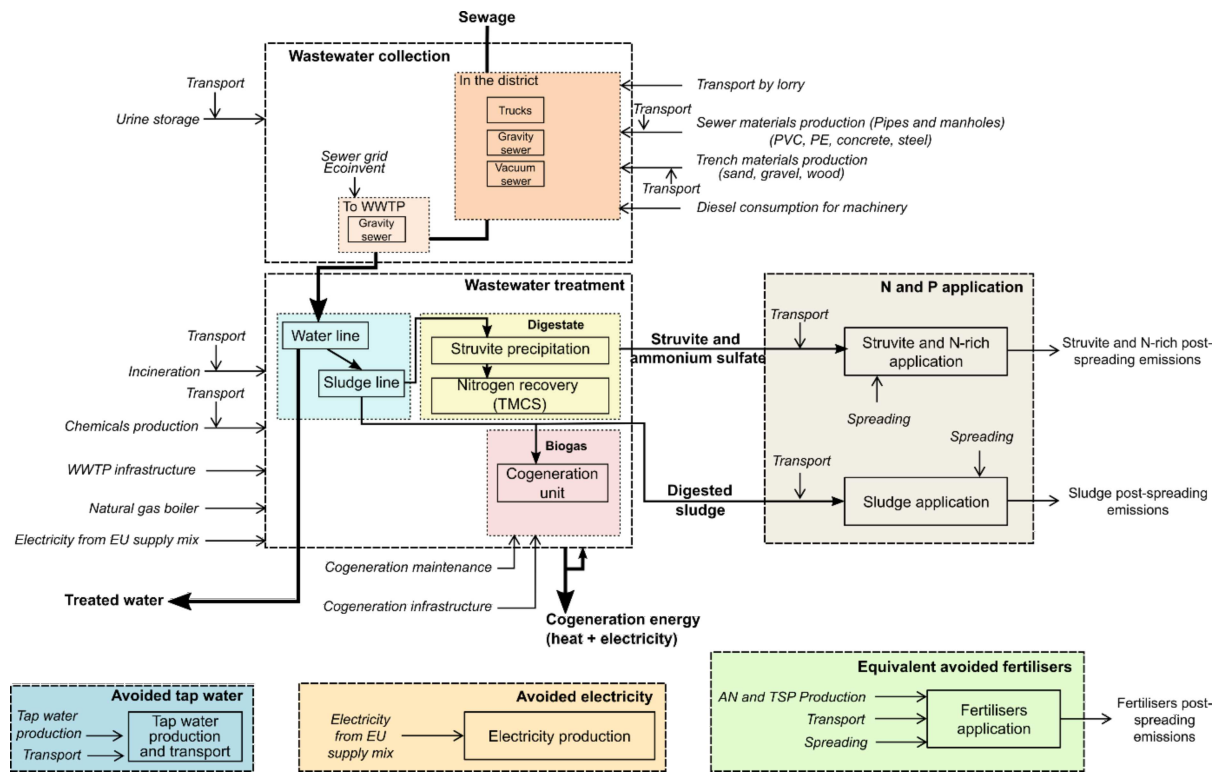

Figure 2: Extended system boundaries for LCA (adapted from (Bisinella de Faria et al., 2015))

2.4.3 Life cycle impact assessment (LCIA)

Environmental impacts were evaluated with endpoint ReCiPe (H, A) and midpoint ReCiPe (H) (Goedkoop et al., 2009). Attributional LCA was performed with UMBERTO software and ecoinvent database v2.2.

2.5 Sensitivity analysis

A sensitivity analysis has been conducted on several parameters that have been identified as uncertain in the literature and relevant to the results. Four parameters have been studied: (1) Emission factor of nitrous oxide from wastewater treatment, (2) efficiency of urine collection in the urine diverting toilet, (3) energy consumption of MBR for greywater treatment, (4) vacuum sewer energy consumption.

Nitrous oxide emissions from WWTP are difficult to evaluate as they vary during the year and with the operating conditions (Vasilaki et al., 2019). Long-term monitoring is therefore necessary but few studies report these data. Thus, nitrous oxide emissions shows a wide range even within similar groups of wastewater treatment processes. Whereas the IPCC value has been used as a baseline (1.6 % of the nitrogen mass flow entering the treatment plant (IPCC, 2019)), the following range of emissions factors have been studied: the emission factor of an activated sludge with extended aeration (0.19 %) from (Filali et al., 2016); the average value (0.87 %) reported by (Vasilaki et al., 2019), the yearly average of emission factor for two biofilters (nitrifying and denitrifying) treatment plant determined from (Bollon, 2016; Bollon et al., 2016).

367 Efficiency of urine collection by the toilet is an uncertain parameter due to limited data related to the
1 368 first generation of urine diverting toilet. Data of (Jönsson et al., 1998, Peter-Fröhlich et al., 2007,
2 369 Vinnerås, 2002, Vinnerås et al., 2006) range indeed from 50 % to 70 % in average. In our study 80 %
3 370 was assumed considering recent improvement with the NoMix toilet from Roediger and the more recent
4 371 toilet Save! from Laufen.
5
6
7

8
9 372 In this study, vacuum sewer consumption is calculated based on the pressure loss according to the sewer
10 373 design (pathway, elevation, design of the lift). However the topography of the district was considered
11 374 flat and vacuum sewer consumption can be impacted by this simplification. In this sensitivity analysis,
12 375 two values from pilot projects have been used: 15 kWh/m³ from Flintenbeite project in Germany
13 376 (Albold, n.d.; OtterWasser GmbH, 2009) and 5.6 kWh/m³ in the Waterschoon project in the Netherlands
14 377 (de Graaff and van Hell, 2014).
15
16
17
18

19 378 Finally, the evaluation of MBR energy consumption for decentralised treatment is really challenging as
20 379 it depends on the type of membrane, the size of the plant and it is in constant evolution. A range from
21 380 0.3 to 8 Nm³/h/m² have been applied in MBR treating greywater at pilot scale (Jefferson et al., 2001;
22 381 Lesjean and Gnirss, 2006; Merz et al., 2007; Peter-Fröhlich et al., 2007). In our study the value of 1.2
23 382 Nm³/h/m² of membrane has been used which is equivalent to 1.5 kWh/m³ of water. However the
24 383 minimum value observed in the literature is around 0.4 kWh/m³ (Jeong et al., 2018, Atanasova et al.,
25 384 2017). Moreover recent studies show also a decrease of full scale MBR treating mixed wastewater, up
26 385 to 0.4 kWh/m³ for MBRs commissioned after 2014 (Brepols, 2020). In the sensitivity analysis, the
27 386 following values have been considered: 1 kWh/m³ and 0.4 kWh/m³.
28
29
30
31
32
33
34
35
36
37
38
39
40
41
42
43
44
45
46
47
48
49
50
51
52
53
54
55
56
57
58
59
60
61
62
63
64
65

387 3. Results

388

389

3.1 Material recovery

390 The recovery efficiency is presented in Figure 3 below and as Sankey diagrams in SI (Figure S 20,
391 Figure S 21 and Figure S 22).

392 3.1.1 Nutrients

393 3.1.1.1 *Reference* scenario

394 In the *Reference* scenario, results show that 14 % of the nitrogen and 82 % of the phosphorus entering
395 the WRRF is captured in the sludge, and only 6 % of nitrogen is converted into a fertilizer (ammonium
396 sulfate and struvite) and 13 % of phosphorus (struvite). Sludge still contains a significant proportion of
397 nutrients which are valorized through sludge spreading but with lower bioavailability than fertilizer.

398 Not surprisingly nitrogen recovery efficiency into fertilizer is limited because most of nitrogen is lost in
399 atmosphere during denitrification. The nitrogen capture would be slightly higher if activated sludge
400 process was operated at higher rate, or if external carbon source or external sludge was provided. For
401 instance (van der Hoek et al., 2018) found 27 % of the N captured in the digester liquor (against 23 %
402 in our study) but with 44% of external sludge treated in the anaerobic digester. (Shi, 2011) reported 12%
403 in the sludge and 10.9% in the centrate after digested sludge dewatering. (Baker et al., 2001) found a
404 value even lower, i.e. only 10 % in the sludge. (See also Table S 21 for a comparison)

405 Regarding phosphorus a major part remains in solid sludge in this *reference* scenario due to the
406 combination with metallic cations as chemical phosphorus removal was performed in complement to
407 biological P removal in the WRRF. The limited amount of nutrients captured as struvite in the digester
408 liquors has been already reported by previous studies and our *reference* result is within the range of
409 reported values. The recovery potential as struvite from digester liquor with respect to the WWTP
410 influent phosphorus load is between 10–25% (Egle et al., 2015). Higher values were obtained for
411 systems with pure biological P removal. For instance (Shi, 2011) reported 20.4% of P measured in the
412 dewatering centrate after anaerobic digestion.

413 3.1.1.2 Source separation scenarios

414 The present study shows that all the source separation scenarios at the level of new district increase the
415 recovery rate of nitrogen up to 48 % in the *Urine* scenario and 54 % for *BW* scenario. The same trend is
416 observed for phosphorus recovery with 58 % for the *Urine* and *BW-GW* scenarios and 73 % for *BW*
417 scenario, thanks to struvite precipitation. It is assumed that urine contains 76 % of the nitrogen of
418 domestic sewage, and only 80 % of the total amount is here collected and sent to recovery. Results show
419 that 60 % of the nitrogen in *Urine* scenario reach TMCS treatment whilst 88.5 % can be recovered in

the blackwater. Therefore, blackwater separation might be slightly more efficient in terms of nitrogen recovery.

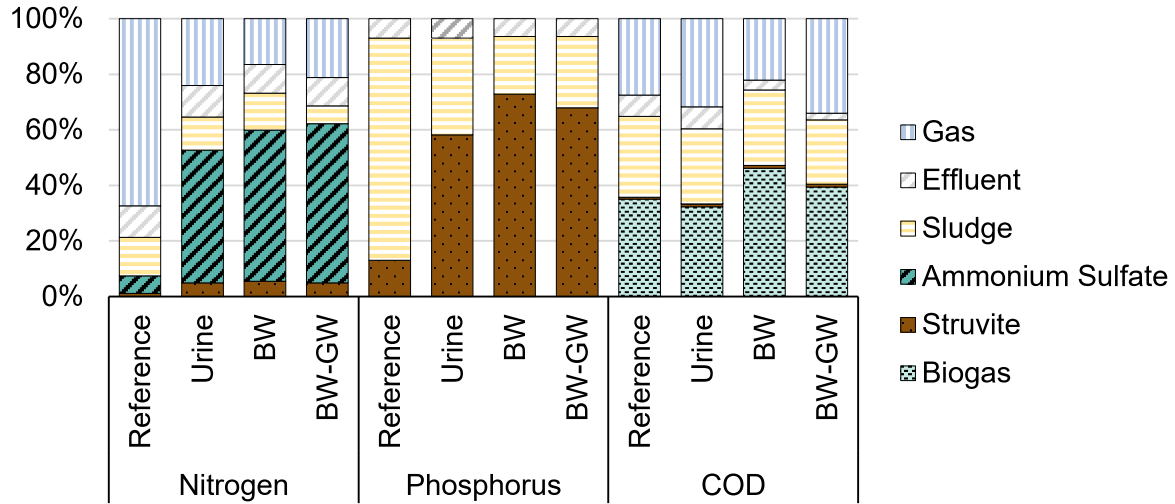

Figure 3: Recovery rates for each scenario and each compound at district scale

Higher phosphorus recovery rate is feasible in source separation scenarios compared to the *Reference* scenario by enhancing biological removal of phosphorus implemented in the WWTP. Indeed, these scenarios showed a slight increase in the ratio of biodegradable COD versus total phosphorus entering the water line and more organic carbon is available for biological P removal as less is used for denitrification (more nitrogen being recovered as ammonia). As showed in Figure S 23 in SI, less iron chloride per entering phosphorus (molar ratio) is thus necessary. Moreover, in both scenarios involving blackwater separation the use of vacuum toilet, reduces the flush water consumption, and in the meantime the effluent concentration is kept to 1 mgP/L. Thus the mass flow in the effluent decreases (7.0 % of the entering phosphorus in the *Reference* scenario and only 6.4 % for *BW* and *BW-GW* scenarios) and the phosphorus recovery in sludge was higher than in the other scenarios.

3.1.2 Organic matter

COD recovery is performed through the production of biogas. In the *Reference* scenario, 35 % of the influent COD is converted into biogas. The digestion of blackwater increased the COD recovery up to 46 % in *BW* scenario and up to 39 % for *BW-GW* scenario. Beside, urine separation was less efficient than the *Reference* scenario (only 32 % of recovery), which can be explained by the fact that 7 % of COD produced by this district is found in the urine and is partly degraded before entering the digester. Moreover by modifying the COD/TN/TP ratio of the wastewater, source separation reduces the need of methanol in post denitrification, necessary to reach the discharge standard for nitrogen. In this perspective, if methanol is considered as the COD inlet, the COD recovery in biogas will be different as

444 presented in Table S 22 in SI. *Reference* scenario presents the worst efficiency with only 32 % of COD
445 converted into biogas whereas for *Urine* and *BW* scenarios it reaches up to 34% and 49% respectively.

446

447 **3.2 Energy balance**

448 If we considered the WRRF of the reference scenario treating effluents from the new district and the
449 city, the system consumes 0.33 kWh/m³ of treated water. By implementing cogeneration with biogas
450 production, electricity and heat are produced. The production of electricity represents only 81 % of the
451 consumption. However, the production of heat by cogeneration is enough to cover twice the actual heat
452 demand. The advanced treatment plant of this study presents rather low energy consumption values
453 compared to current wastewater treatment plants which show power consumptions ranging from 0.3 to
454 0.8 kWh/m³, without any recovery processes. These recovery processes accounted for 3 % of the total
455 electricity demand in WRRFs and 58 % of the demand in heat.

456 As stated previously, only the additional environmental costs for managing the sewage from the new
457 district are then analyzed. The electricity balance of the four scenarios are compared in Figure 4 for the
458 entire sanitation system with transport and treatment. The black bars represent the balance between extra
459 consumption and extra production compared to the operation of WRRF without the new district. A
460 negative value means higher extra production than extra consumption. In the Figure 4, the electricity
461 needed for the nutrients recovery installed in the WRRF are taken into account in the category “WRRF”,
462 whereas the electricity consumption for MBR in *BW-GW* scenario and nutrients recovery in *BW* and
463 *BW-GW* scenario are detailed in the “Decentralized treatment” category.

464 For electricity balance, the scenarios are all energy positive except *BW-GW*. Reference scenario and
465 *Urine* scenario are close (-8 to -9 kWh_{elec}/PE/year), *BW* scenario is less beneficial (- 4.4
466 kWh_{elec}/PE/year) whereas the last scenario *BW-GW* needs 6 times more electricity than it can produce.
467 It has to be highlighted that even if for the first three scenarios the overproduction of biogas compensated
468 the electricity consumption, the WRRF is still not energy neutral. Indeed for the new district, the
469 production of electricity increases faster than the consumption.

1
2
3
4
5
6
7
8
9
10
11
12
13
14
15
16
17
18
19
20
21
22
23
24
25
26
27
28
29
30
31
32
33
34
35
36
37
38
39
40
41
42
43
44
45
46
47
48
49
50
51
52
53
54
55
56
57
58
59
60
61
62
63
64
65

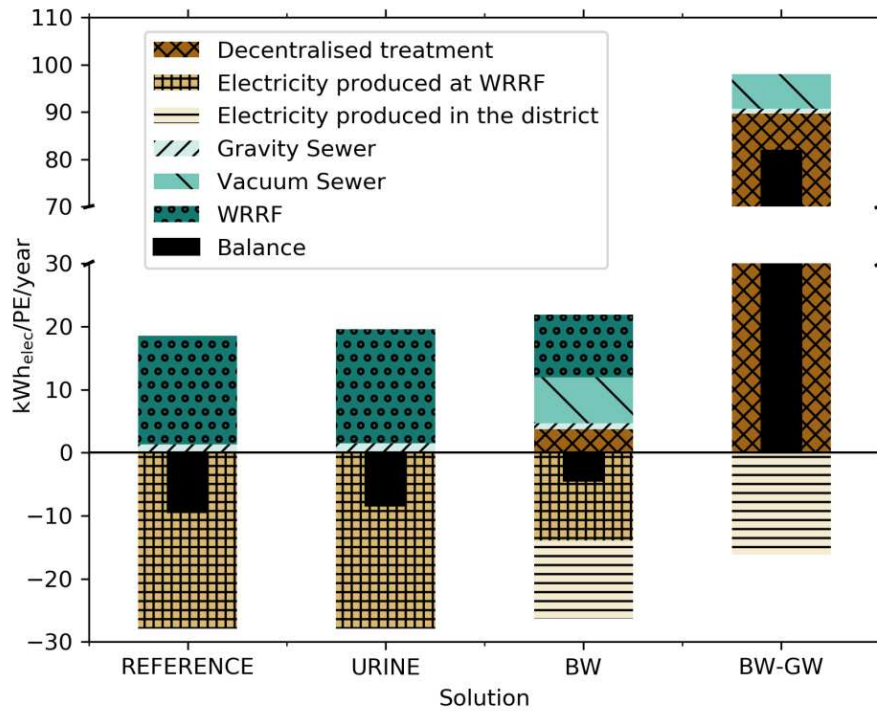

Figure 4: Electricity balance for each scenario taking into account transport and treatment needs and production

Urine separation increases the electricity consumption due to a higher demand from the nitrogen recovery process train (see also Figure S 24 in SI with a focus on WRRF balance), energy consumption increasing proportionally with the nitrogen recovered by TMCS. In the meantime, as previously discussed, the production of electricity from biogas decreased in the *Urine* scenario, and leads to a slightly less beneficial balance.

In the *BW* scenario, blackwater is treated in the district and greywater is sent to WRRF. Moreover energy consumption is added for the transport of blackwater by using a vacuum sewer. Results show that the consumption in the WRRF is around two-fold lesser (1.7) than those in the Reference (9.9 kWh/PE/year versus 17.2 kWh/PE/year). This gain is related to a decrease in the need for aeration in the centralized plant since nitrogen is previously removed and treated at the district scale. The production of electricity is shared respectively in the WRRF and in the district, with the same range of production than in the *Reference* scenario. As a conclusion *BW* scenario presents a beneficial energy balance (electricity) but provides less energy compared to the *Reference*.

In the last scenario including decentralized treatment of greywater (*BW-GW*), results show that the greywater treatment needs much more electricity than all the other scenarios, with a total consumption around 100 kWh_{elec}/PE/year compared to around 20 kWh_{elec}/PE/year for all the other scenarios. This is due to the treatment systems for greywater. Indeed, the energy demand of the membrane bioreactor at district scale varies between 0.3 and 8 Nm³/h/m² (1.2 Nm³/h/m² was used in this simulation). Even if the

491 best performance is used for airflow consumption, such as 0.27 Nm³/h/m² (Atanasova et al., 2017), this
492 scenario will still present a higher electricity consumption (34 kWh/PE/year) and not a beneficial
493 balance. Finally, the production of electricity in *BW-GW* scenario is lower than all the other scenarios,
494 even though the organic matter recovery rate is higher (39 % against 35 %). This is due to the fact that
495 at a small scale, cogeneration production unit provides more heat than electricity.

3.3 LCA result

3.3.1 Endpoint impact categories

501 The first analysis undertaken on endpoint impacts shows (Figure 5) that climate change impact
502 dominates the human health and ecosystem quality categories. For all scenarios, human health category
503 is the most impacted with on average 53 % overall impacts, followed by resources (around 26 %) and
504 ecosystem quality (around 22 %). *Urine* and *BW* scenarios present a reduction of impacts for all three
505 categories of damage (ecosystem quality human health and resources). Benefits are provided by the
506 diminution of fossil depletion and climate change impact on both human health and ecosystems.
507 Moreover the two impacts (climate change and fossil depletion) are correlated. Source separation
508 scenarios did not significantly change particulate matter formation and toxicity towards humans
509 (micropollutants were not considered). The individual impacts will also be analyzed in mid-point impact
510 category hereafter.

1
2
3
4
5
6
7
8
9
10
11
12
13
14
15
16
17
18
19
20
21
22
23
24
25
26
27
28
29
30
31
32
33
34
35
36
37
38
39
40
41
42
43
44
45
46
47
48
49
50
51
52
53
54
55
56
57
58
59
60
61
62
63
64
65

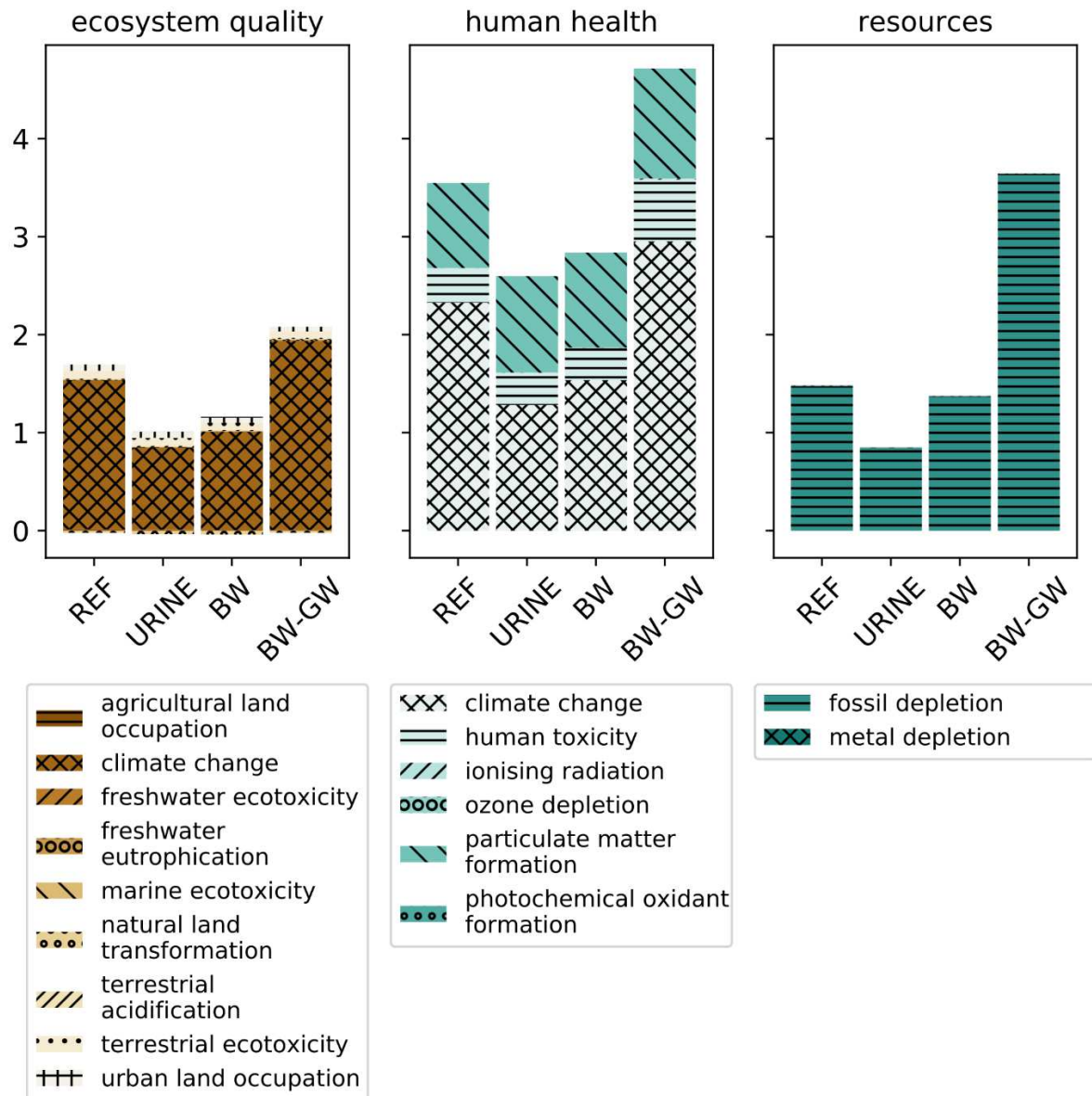

Figure 5: Endpoint results for ecosystems quality, human health and resources depletion impact categories

3.3.2 Midpoint methods

The endpoint results revealed that climate change (accompanied by fossil depletion) is the major contributor. The contribution analysis on this impact category is first presented. Then, the midpoint results will be analyzed by comparing the scenarios for each impact category.

Detailed graphics can be found in SI (from Figure S 25 to Figure S 41).

3.3.2.1 Contribution analysis

Figure 6 shows the impact on climate change for each scenario, positive values represent impacts caused by our system. The negative values of the graph represent impacts which are avoided. Avoided impacts are generated outside the boundaries of the studied system, for example avoided conventional fertilizer,

523 tap water production, but also the emissions linked to spreading of conventional fertilizers. The black
524 bars, which represent the balance between impacts and avoided impacts, help to compare different
525 scenarios: the smallest the bar, the better the scenario. Moreover, when we refer to the “impact of the
526 system”, only the positive values are considered.

527 It can be concluded that both *Urine* and *BW* scenarios have less impact on climate change compared to
528 the *Reference*. *Urine* and *BW* separation can reduce by 45 % and 34 % climate change impact. On the
529 contrary, *BW-GW* scenario shows an increase by 27 % of climate change impact.

530 The main contributions for the *Reference* scenario are the WRRF infrastructure, sewer infrastructure
531 and direct emissions: nitrous oxide (N₂O), methane, CO₂ into air and discharge water emissions. Thanks
532 to the substitution of nitrogen and phosphorus fertilizer, separation scenarios can reduce climate change
533 impact. However, the avoided phosphorus fertilizer production contributes less to the avoided fertilizer
534 production and use (from Figure 6) than avoided nitrogen fertilizer production. Indeed avoided P-
535 fertilizer production represents 26 % of the avoided fertilizer production and use for *Reference* scenario
536 and only 8 % for the source separation scenario. Avoided N-fertilizer production contributes to 56 %
537 for the *Reference* and up to 70 % for source separation scenarios. The remaining contributor to this
538 category are the avoided emissions linked to the fertilizer spreading and the post-spreading emissions.
539 This avoided impact of fertilizer production compensates the increase of emissions from the new specific
540 infrastructure for both *Urine* and *BW* scenarios. Indeed, the *Urine* scenario needs collection transport
541 which contributes to 4 % of the total emissions. More recovered fertilizer is spread into fields which
542 increases greenhouse gas emissions (title co-products valorization in Figure 6). While higher recovery
543 is described, a significant decrease of direct emissions is visible (60 %). This is due to less N₂O
544 emissions explained by a reduced amount of nitrogen entering the WRRF. The *BW* scenario is less
545 beneficial than *Urine* scenario for climate change because more energy (heat) is needed for the nitrogen
546 recovery process in the case of blackwater compare to *Urine* (due to nitrogen concentration). The
547 emissions related to this energy demand (boiler operated with natural gas) represent 15 % of the total
548 emissions.

549

ReCiPe Midpoint (H) - climate change, GWP100

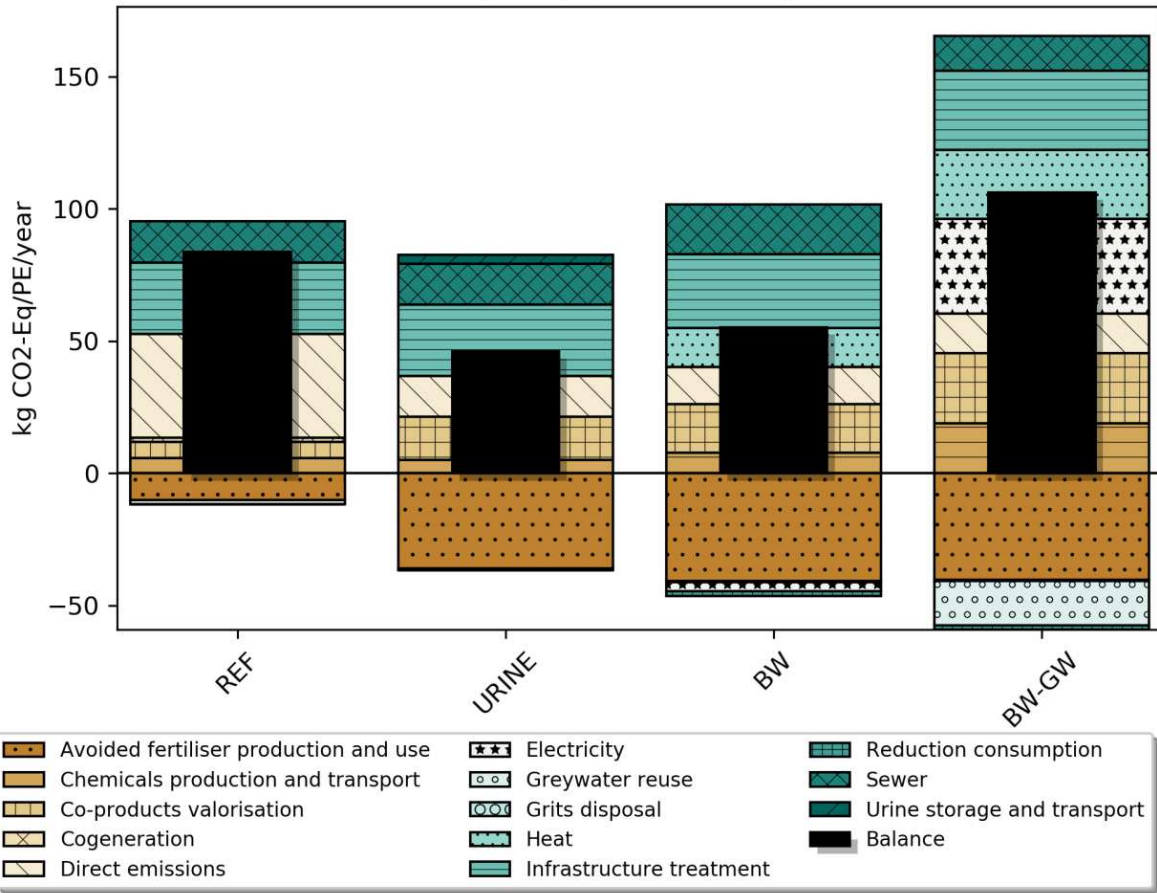

Figure 6: Comparison of the four scenarios on climate change impact (ReCiPe Midpoint H)

For the last scenario with decentralized blackwater and greywater treatment systems (*BW-GW*), the total balance increases by 27 % compared to the *Reference*. The emissions related to energy consumption (heat and electricity) represent 37 % of climate change impact, thereby increasing the emissions compared to the *Reference* scenario. Heat demand is once again a major source of impact with 16 % of the emissions. As described in *Urine* and *BW* scenarios, the direct emissions are reduced significantly (62 %) by reducing N₂O emissions. Nevertheless, the overall emissions are not balanced by avoided impacts, such as production of fertilizer and reuse of greywater for non-potable use.

3.3.2.2 Integrated analysis

All impact results with midpoint methods are summarized in Figure 7. They are normalized with the value of the *Reference* scenario, meaning that if the value is above 1, the impact is higher than the *Reference*. If we consider significant only the variation of 20 % of the impact categories compared to *Reference*, *Urine* scenario have similar results for most the categories (11), and impact better for 5 of them and only 2 worse than the reference: ionizing radiation and water depletion. The degradation of

567 water depletion is linked to the production of magnesium and is not compensated, in this scenario, by
 568 decrease in water consumption.

569 *BW* scenario presents 5 improved categories and 4 with a worse impact than *Reference*.

570 The *BW-GW* scenario represents the worst situation with 6 impact categories with values reaching 1.5
 571 times higher than the *Reference*. These categories are all negatively impacted by to the high energy
 572 consumption of greywater treatment.

573 Agricultural land occupation and natural land transformation are strongly reduced with the source
 574 separation scenario thank to the increase of avoided fertilizer production and especially nitrogen.

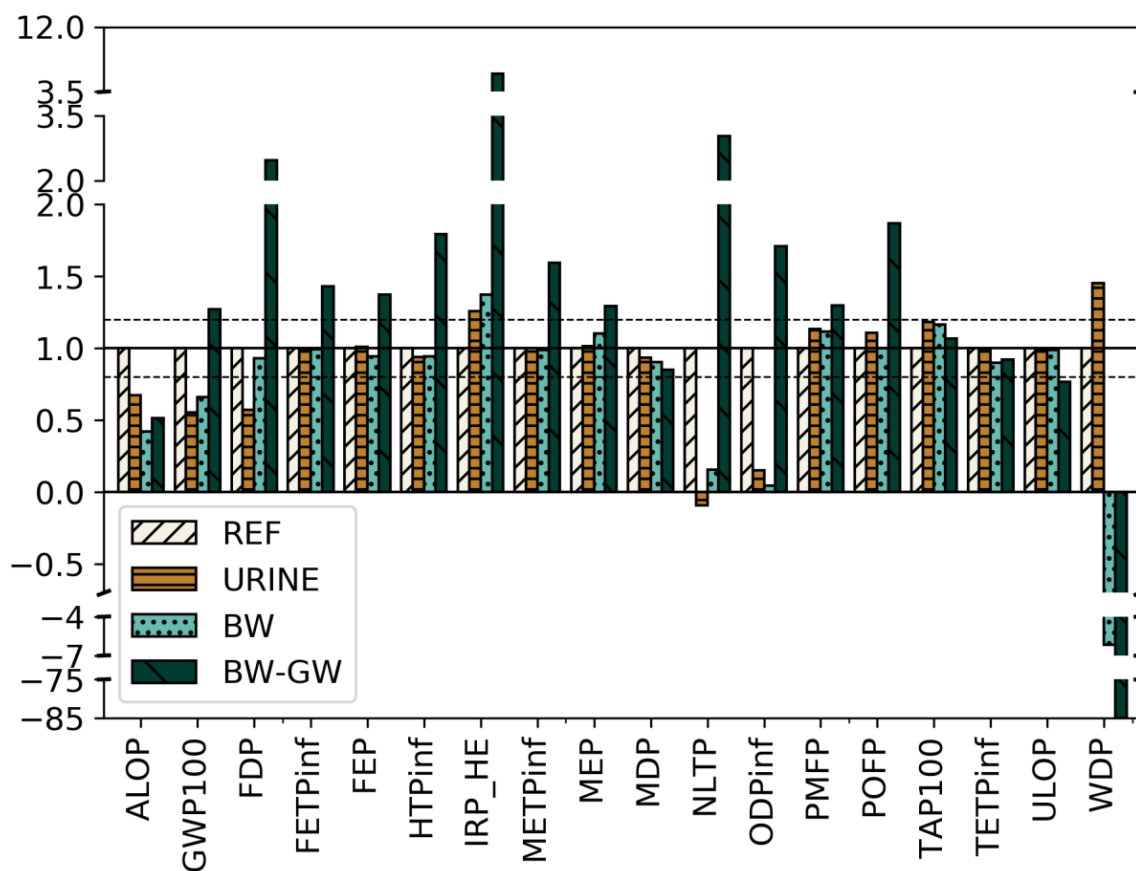

575
 576 *Figure 7: Normalized comparison of all scenarios to the reference scenario, for each category of impact at midpoint level*
 577 *(ReCiPe H). ALOP: agricultural land occupation, GWP100: climate change, FDP: fossil depletion, FETPinf: freshwater*
 578 *ecotoxicity, FEP: freshwater eutrophication, HTPinf: human toxicity, IRP_HE: ionising radiation, METPinf: marine*
 579 *ecotoxicity, MEP: marine eutrophication, MDP: metal depletion, NLTP: natural land transformation, ODPinf: ozone*
 580 *depletion, PMFP: particulate matter formation, POFP: photochemical oxidant formation, TAP100: terrestrial acidification,*
 581 *TETPinf terrestrial ecotoxicity, ULOP: urban land occupation, WDP: water depletion.*

582 **3.4 Sensitivity analysis**

1 583 In the following paragraphs, only the impact on climate change has been discussed. The results for the
2
3 584 other impact categories are presented in the supplementary Tables S27, S28 and S29.
4

5 585 3.4.1 Nitrous oxide emissions from wastewater treatment

6 586 The four emissions factors studied in the sensitivity analysis show that the rank of each scenario is not
7
8 587 modified concerning the climate change impact. However with low emission factor (0.19%) *Urine*
9
10 588 scenario can only decrease climate change impact by 25 % compared to the *Reference* scenario and only
11
12 589 14 % decrease is observed for *BW* scenario. On the contrary, with high N₂O emissions factor *BW-GW*
13
14 590 scenario has a similar impact on climate change than the *Reference* (7 % increase).
15

16 591 3.4.2 Efficiency of urine collection in the toilet

17 592 For all the studied efficiencies of urine collection, *Urine* scenario still presents an improvement
18
19 593 regarding climate change impact with a GHG emission reduction from 27 % to 45 % compared to
20
21 594 *Reference*. However below 65 % of urine collection efficiency, the climate change impact of *Urine*
22
23 595 scenario is similar to *BW* scenario.
24

25 596 3.4.3 Energy consumption for the vacuum sewer

26 597 Regarding climate change impact, *BW* scenario still presents a better balance (11 % of improvement)
27
28 598 than the *Reference* scenario even with 15 kWh/m³ consumed for the vacuum collection of blackwater.
29
30 599 With an energy consumption higher than 21 kWh/m³, *BW* scenario presents a worse balance on climate
31
32 600 change impact. For *BW-GW* scenario this does not change the conclusion. Even without energy
33
34 601 consumption for vacuum sewer, this scenario still increases by 11 % the climate change impact of the
35
36 602 system.
37

38 603 3.4.1 Energy consumption of the membrane bioreactor

39 604 MBR energy consumption has a strong effect on the climate change impact for *BW-GW* scenario. Indeed
40
41 605 the emissions vary from 79 kgCO₂eq/PE/year to 106 kgCO₂eq/PE/year by varying from 0.4 kWh/m³ to
42
43 606 1.5 kWh/m³. Above the value of 0.56 kWh/m³ for MBR electricity consumption, *BW-GW* scenario
44
45 607 presents a degraded climate impact compared to the *Reference* scenario. A reduction of more than twice
46
47 608 the current value would be necessary to reach a similar impact as reference.
48

49 609

50 610

51

52

53

54

55

56

57

58

59

60

61

62

63

64

65

611 4. Discussion

612

613 4.1 Benefits of urine and black water separation scenarios

614 In this study three different wastewater management scenarios with source separation were compared
615 to a centralized WRRF operating with nutrient recovery. Globally the results shows that *Urine* and *black*
616 *water* separation can reduce by 45 % and 34 % climate change impact respectively. Climate change is
617 the most important category regarding LCA (contribution to endpoint). High nitrogen recovery is the
618 major explanation for such improvement, because it reduces direct N₂O emissions and decreases the
619 needs for chemical fertilizers. Nevertheless nitrogen recovery process can generate significant energy
620 demand (heat), which negatively impacts the results for the *BW* scenario for instance. The *BW-GW*
621 scenario including greywater recovery is very beneficial regarding the water depletion criterion (WDP),
622 but it is negatively impacted by the high energy needs of decentralized membrane treatment technology
623 (MBR) resulting in more impact on climate change. Moreover to achieve *BW-GW* scenario, all the
624 greywater needs to be reused by replacing tap water, but the flush water volume will only represent 6 %
625 of the available amount of greywater. To reach this water recovery level, new applications need to be
626 found, such as for irrigating green spaces, cleaning roads...

627 In this study, urine and blackwater separation showed comparable phosphorus recovery thank to the
628 biological removal of phosphorus in the centralized WRRF. In this way, the P from the feces was also
629 recovered in the digestate. (Meinzinger et al., 2010) showed different P recovery rates when chemical
630 removal of phosphorus was implemented in the WRRF. Indeed, phosphorus recovery was found to be
631 3 times higher for blackwater separation compared to *Urine*.

632 Regarding energy, the *Urine* and *BW* scenarios showed close electricity balances compared to the
633 *Reference*. Source separation did not significantly improve the recovery of COD in the form of methane,
634 compared to the WRRF. The extra consumption due to the collection steps using vacuum pumps was
635 compensated by the reduction in aeration in the WRRF. Moreover the production of electricity was not
636 improved with direct digestion of blackwater (*BW* and *BW-GW* scenarios) because of the lower
637 electricity efficiency of CHP with a decentralized scale. (Thibodeau et al., 2014a) found a similar
638 conclusion for blackwater separation: the energy production from blackwater digestion was reduced
639 compared to wastewater digestion, because organic matter from greywater was not degraded. For the
640 *BW-GW* scenario, energy consumption by the MBR was not compensated by the energy production
641 which led to an unfavorable electricity balance. (Remy, 2010) found similar conclusions on MBR
642 consumption and energy balances of the *BW-GW* scenario. Finally, the use of TMCS for N recovery
643 consumed large amounts of heat. If installed at the centralized WRRF, the extra heat requirements can
644 be fulfilled by the extra heat produced by the wastewater coming from the city, which is not the case at

645 decentralized plants. Moreover blackwater is more diluted than the supernatant from digestate and more
1 646 energy is required to heat it up to 45°C.

3
4 647 Regarding endpoint damages, the impact of the wastewater management system compared to the
5 648 *Reference* was reduced for *Urine* and *BW* scenarios but increased for *BW-GW*. The main contributors
6
7 649 were climate change and particulate matter formation on human health, fossil depletion and climate
8
9 650 change on ecosystem quality.

10
11 651 Regarding midpoint impacts, no clear conclusion can be drawn from the analysis of the 18 impact
12
13 652 categories. However, *BW-GW* scenario presented the most categories with worst results, mainly due to
14
15 653 the high energy consumption of the MBR. Reduction of climate change impact observed in the *Urine*
16 654 and *BW* scenarios, was due to the reduction of N₂O emissions and the avoided production of nitrogen
17
18 655 fertilizer. (Thibodeau et al., 2014a) reported different conclusions between a *reference* and a *BW*
19
20 656 scenarios with an increase of 23 %. However, authors did not take into account any direct emission from
21
22 657 WWTP, nor any post spreading emissions from mineral fertilizers.

23
24 658 It has to be emphasized that the WRRF used as a reference already provides high environmental
25
26 659 performances. For example, compared to average value for conventional WWTP, a 14 % of decrease in
27
28 660 climate change impact is observed for our advanced WRRF (0.9 kgCO₂eq/m³ for our reference
29
30 661 compared to 1.05 kgCO₂eq/m³ for conventional WWTP of (Bisinella de Faria et al., 2015) (with the
31
32 662 same N₂O emission factors and without sewer). In this perspective, source separation, and especially
33
34 663 *Urine* separation is currently the best option to significantly reduce the impact on climate change (in our
35
36 664 study, 45 % of decrease for *Urine* scenario at district scale).

37
38 665 Finally, in this study, the European energy mix of 2004 has been used for the LCA analysis. Changing
39
40 666 the energy sources will have a major effect on the related impact categories i.e. climate change, fossil
41
42 667 depletion, particulate matter formation. Electricity mix varies from a country to another and will change
43
44 668 in the near future by increasing the proportion of renewable resources.

45
46 669 Indeed, the European electricity mix of 0.5 kgCO_{2-eq}/kWh is assumed, however, for example,
47
48 670 prospective scenarios in Spain can achieve 0.039 kgCO_{2-eq}/kWh in 2050 with 80 % GHG emission
49
50 671 reduction compare to 2005 (García-Gusano et al., 2017).

51
52 672 Moreover, if the current French mix is used, a low impact on climate change category will be observed
53
54 673 since the emission factor in France is only 0.078 kgCO_{2-eq}/kWh due to the large proportion of nuclear
55
56 674 energy. However, the ionizing radiation impact will show an increase since the emission factor is 0.53
57
58 675 against 0.37 kg U235-eq/kWh. Whatever the energy resources, the ranking of the four scenarios (if placed
59
60 676 on the same geographic context) will not change since it is determined by the energy consumption. The
61
62 677 remaining question is if a green energy could justify the choice of an energy intensive scenario. Even if
63
64 678 in the future fossil energy will be more and more replaced by renewable one, the humanity is constrained
65

679 at drastically reduce the energy consumption (IPCC, 2018) from now on, since renewable resources are
680 limited and less efficient.

681

682 **4.2. Possible directions for optimization and future research**

683 From this study several directions for future research can be proposed in relation with energy balance
684 and associated climate change impacts.

685 First, regarding the nitrogen recovery approaches, technologies still need to be optimized and validated.
686 Attention should be paid to the energy demand and practical applicability regarding different effluent
687 sources. Here the TMCS was assumed to be the optimal process ($2.55 \text{ kWh}_{\text{elec}}/\text{kgN}_{\text{recovered}}$ (Böhler et al.,
688 2018; Zhang et al., 2020)) whereas other commercialized techniques can be much more energy
689 consuming (ex: Nitrification/distillation: $76 \text{ kWh}_{\text{elec}}/\text{kgN}_{\text{recovered}}$ (Udert and Jenni, 2013; Udert and
690 Wächter, 2012), stripping: $7 \text{ kWh}_{\text{elec}}/\text{kgN}_{\text{recovered}}$ (Maurer et al., 2003; Zhang et al., 2020) or even
691 nitrification/denitrification: $4 \text{ kWh}_{\text{elec}}/\text{kgN}_{\text{recovered}}$ (Maurer et al., 2003)). Even if the TMCS process for
692 nitrogen recovery seems relevant to implement, heat consumption should be optimized. Several options
693 should be investigated. Firstly, heat recovery from the effluent could be installed in order to pre-heat the
694 inlet. Secondly, greywater heat can also be recovered. Indeed, this can account for a large source of heat
695 but at a low temperature (below 40°C). Moreover, reducing the heat demand by limiting the flowrate
696 can be an option for blackwater treatment. In a final step, other sources of heat can also be investigated
697 to reduce the impact on climate change. For instance, using a boiler with wood pellets has only an
698 emission factor of $0.016 \text{ kgCO}_{2\text{-eq}}/\text{MJ}$ (Ecoinvent database v3.6), against $0.07 \text{ kgCO}_{2\text{-eq}}/\text{MJ}$ for the
699 natural gas boiler (Ecoinvent Database v2.7).

700 Future research should also focus on a detailed integration of treatment infrastructure in life cycle
701 assessment in order to refine the results for decentralized infrastructure. Indeed in this study, the
702 infrastructure is only based on the treated PE and Ecoinvent database for WWTP infrastructure.

703 For future scenarios analysis one should also consider the possible transformation of treatment train
704 regarding emerging technologies on the mainstream. For instance COD recovery can be improved by
705 producing more primary sludge with an enhanced primary sedimentation tank, or high-rate activated
706 sludge. In addition the combination of biological removal of phosphorus and anammox bacteria in the
707 mainstream is a promising alternative but still needs to be demonstrated (for both centralized and
708 decentralized treatment). A current challenge is to guaranty performance of anammox systems in the
709 mainstream under cold climate whereas successful trial was reported by (Cao et al., 2017) under warm
710 climate. However, from an environmental point of view, a mitigation strategy of N_2O emissions should
711 be found for partial nitritation and anammox applications, as a very small increase of such emission can
712 completely reverse the advantages in terms of energy saving (Besson et al., 2017).

713 To improve the energy balance of *BW* and *BW-GW* scenarios, increasing the heat production from
714 cogeneration can also be an option. By considering the decentralized treatment, co-digestion of
715 blackwater with kitchen waste can be imagined as it is considered in future scenarios deployed in
716 Northern European countries for instance (Skambraks et al., 2017). This strategy shows valuable
717 environmental results (Thibodeau et al., 2014a; Vergara-Araya et al., 2020).

718 Greywater treatment at small scale is another research topic to investigate as energy consumption of
719 MBR revealed to be highly impacting on climate change. Moreover progress have been made to reduce
720 the energy consumption of full scale MBR up to 0.4 kWh/m³ for MBRs commissioned after 2014
721 (Brepols, 2020). These progress can be beneficial if they can be extended to small scale MBR treating
722 greywater. Indeed with such level of energy consumption the same climate change impact as the
723 *Reference* scenario could be achieved.

724 5. Conclusions

725 A tool was developed to model the collection and decentralized treatment at the district scale. The effect
726 on the centralized treatment plant is taken into account through plant-wide modelling. Results obtained
727 from the simulation are used as inventory for the LCA. This study aimed to compare several options in
728 order to enhance the recovery of resources from wastewater by using a WRRF coupled with, or without,
729 source separation systems. The mains results from this study are:

- 730 • Both *Urine* and *BW* scenarios can reduce greenhouse gas emissions by respectively 45 % and
731 34 %.
- 732 • At endpoint level, climate change is the most important category for all the scenarios. Regarding
733 other LCA midpoint categories, *Urine* and *BW* scenarios show similar results in most impact
734 categories, whilst the *BW-GW* scenario only improved water depletion category.
- 735 • Nitrogen recovery is the most impacting aspect regarding LCA results. Source separation of
736 urine or blackwater can achieve a much better recovery compared to centralized WRRF. This
737 benefit is related to both chemical fertilizer substitution and reduction of N₂O emissions from
738 biological treatment. However nitrogen recovery technique (here TMCS) is a sensitive
739 consumer of energy, and future effort should be paid to ensure proper design and operation of
740 this process for source separation.
- 741 • Greywater water reuse scenario appears globally negative for climate change. This is due to
742 high energy demand of decentralized membrane treatment (MBR) which is not compensated by
743 avoided potable water production. However the benefit of water recycling and reducing the
744 pressure on water bodies should be more considered in the future. Conclusion would be different
745 depending on the context (decarbonized energy or drinking water production with high GHG
746 emissions).

747 **6. Acknowledgment**

1
2
3 748 This work was supported by the Water Board of Adour Garonne (Agence de l'eau Adour Garonne,
4 749 France) for the MUSES project and the French Agency of Research (ANR) [grant numbers ANR-17-
5
6 750 CE22-0017] for the DESIGN project.
7
8
9
10
11
12
13
14
15
16
17
18
19
20
21
22
23
24
25
26
27
28
29
30
31
32
33
34
35
36
37
38
39
40
41
42
43
44
45
46
47
48
49
50
51
52
53
54
55
56
57
58
59
60
61
62
63
64
65

751 **7. References**

- 1
2
3 752 Albold, A., n.d. Flintenbreite. Available at :
4 753 [http://www.findera.fi/files/20130514Flintenbreite%20\(2\).pdf](http://www.findera.fi/files/20130514Flintenbreite%20(2).pdf)
5
6
7 754 Arocha, J.S., McCann, L.M.J., 2013. Behavioral economics and the design of a dual-flush toilet. *Journal*
8 755 *- American Water Works Association* 105, E73–E83. <https://doi.org/10.5942/jawwa.2013.105.0017>
9
10
11 756 Atanasova, N., Dalmau, M., Comas, J., Poch, M., Rodriguez-Roda, I., Buttiglieri, G., 2017. Optimized
12 757 MBR for greywater reuse systems in hotel facilities. *J. Environ. Manage.* 193, 503–511.
13 758 <https://doi.org/10.1016/j.jenvman.2017.02.041>
14
15
16 759 Baker, L.A., Hope, D., Xu, Y., Edmonds, J., Lauver, L., 2001. Nitrogen Balance for the Central Arizona-
17 760 Phoenix (CAP) Ecosystem. *Ecosystems* 4, 582–602. <https://doi.org/10.1007/s10021-001-0031-2>
18
19
20
21 761 BERLAND, J.-M., 2014. Assainissement des agglomérations. *Tech. Ing. Gest. Eau base documentaire :*
22 762 *TIB234DUO.*
23
24
25 763 Besson, M., Tiruta-Barna, L., Spérandio, M., 2017. Environmental Assessment of Anammox Process in
26 764 Mainstream with WWTP Modeling Coupled to Life Cycle Assessment, in: *Frontiers in Wastewater*
27 765 *Treatment and Modelling*. Presented at the Frontiers International Conference on Wastewater Treatment
28 766 and Modelling, Springer, Cham, pp. 392–397. https://doi.org/10.1007/978-3-319-58421-8_62
29
30
31
32 767 Bisinella de Faria, A.B., Spérandio, M., Ahmadi, A., Tiruta-Barna, L., 2015. Evaluation of new
33 768 alternatives in wastewater treatment plants based on dynamic modelling and life cycle assessment (DM-
34 769 LCA). *Water Res.* 84, 99–111. <https://doi.org/10.1016/j.watres.2015.06.048>
35
36
37
38 770 Böhler, M., Hernandez, A., Gruber, W., Fleiner, J., Seyfried, A., 2018. POWERSTEP. WP4 : Nitrogen
39 771 management in side stream. D 4.3: Operation and optimization of membrane ammonia stripping
40 772 (Deliverable No. 4.3). Eawag.
41
42
43 773 Bollon, J., 2016. Full-scale post denitrifying biofilters: sinks of dissolved N₂O? *Science of the Total*
44 774 *Environment* 9.
45
46
47 775 Bollon, J., Filali, A., Fayolle, Y., Guerin, S., Rocher, V., Gillot, S., 2016. N₂O emissions from full-scale
48 776 nitrifying biofilters. *Water Research* 102, 41–51. <https://doi.org/10.1016/j.watres.2016.05.091>
49
50
51
52 777 Bonhomme, M., Ait Haddou, H., Adolphe, L., 2012. GENIUS: A tool for classifying and modelling
53 778 evolution of urban typologies. Presented at the 28th Conference, Opportunities, Limits & Needs
54 779 Towards an environmentally responsible architecture, PLEA2012, Lima, Peru.
55
56
57
58
59
60
61
62
63
64
65

780 Bonoli, A., Di Fusco, E., Zanni, S., Lauriola, I., Ciriello, V., Di Federico, V., 2019. Green Smart
781 Technology for Water (GST4Water): Life Cycle Analysis of Urban Water Consumption. *Water* 11, 389.
782 <https://doi.org/10.3390/w11020389>

783 Bourrier, R., 2008. *Les réseaux d'assainissement - calculs, applications, perspectives (5e éd.)*. Lavoisier.

784 Bowne, W.C., Naret, R.C., Otis, R.J., 1991. *Manual - alternative wastewater collection systems (Manual*
785 *No. EPA/625/1-91/024)*. U.S. Environmental Protection Agency, Office of research and development,
786 National risk management research laboratory., Cincinnati, Ohio, USA.

787 Brepols, C., 2020. 9 - Sustainable adoption and future perspectives for membrane bioreactor
788 applications, in: Mannina, G., Pandey, A., Larroche, C., Ng, H.Y., Ngo, H.H. (Eds.), *Current*
789 *Developments in Biotechnology and Bioengineering*. Elsevier, pp. 205–233.
790 <https://doi.org/10.1016/B978-0-12-819854-4.00009-5>

791 Bullnheimer, B., Hartl, R.F., Strauss, C., 1999. Applying the ANT System to the Vehicle Routing
792 Problem, in: Voß, S., Martello, S., Osman, I.H., Roucairol, C. (Eds.), *Meta-Heuristics: Advances and*
793 *Trends in Local Search Paradigms for Optimization*. Springer US, Boston, MA, pp. 285–296.
794 https://doi.org/10.1007/978-1-4615-5775-3_20

795 Cao, Y., Kwok, B.H., van Loosdrecht, M.C.M., Daigger, G.T., Png, H.Y., Long, W.Y., Chye, C.S.,
796 Ghani, Y.A.B.D., 2017. The occurrence of enhanced biological phosphorus removal in a 200,000 m³
797 /day partial nitrification and Anammox activated sludge process at the Changi water reclamation plant,
798 Singapore. *Water Sci. Technol.* 75, 741–751. <https://doi.org/10.2166/wst.2016.565>

799 EVAC, n.d. Vacuum technology [WWW Document]. Evac. URL <https://evac.com/vacuum-technology/>

800 Damtie, M.M., Volpin, F., Yao, M., Tijning, L.D., Hailemariam, R.H., Bao, T., Park, K.-D., Shon, H.K.,
801 Choi, J.-S., 2020. Ammonia recovery from human urine as liquid fertilizers in hollow fiber membrane
802 contactor: Effects of permeate chemistry. *Environmental Engineering Research* 26.
803 <https://doi.org/10.4491/eer.2019.523>

804 de Graaff, M.S., Temmink, H., Zeeman, G., Buisman, C.J.N., 2010. Anaerobic Treatment of
805 Concentrated Black Water in a UASB Reactor at a Short HRT. *Water* 2, 101–119.
806 <https://doi.org/10.3390/w2010101>

807 de Graaff, R., van Hell, A.J., 2014. *Nieuwe Sanitatie Noorderhoek, Sneek deelonderzoeken (New*
808 *Sanitation Noorderhoek, Sneek sub-studies) (No. 2014–48)*, STOWA. STOWA, Amersfoort -
809 Netherlands.

810 Diaz-Elsayed, N., Rezaei, N., Guo, T., Mohebbi, S., Zhang, Q., 2019. Wastewater-based resource
811 recovery technologies across scale: A review. *Resources, Conservation and Recycling* 145, 94–112.
812 <https://doi.org/10.1016/j.resconrec.2018.12.035>

813 Dorigo, M., Gambardella, L.M., 1997. Ant colonies for the travelling salesman problem. *Biosystems*
1 814 43, 73–81. [https://doi.org/10.1016/S0303-2647\(97\)01708-5](https://doi.org/10.1016/S0303-2647(97)01708-5)
2
3
4 815 Egle, L., Rechberger, H., Zessner, M., 2015. Overview and description of technologies for recovering
5 816 phosphorus from municipal wastewater. *Resources, Conservation and Recycling, Losses and*
6
7 817 *Efficiencies in Phosphorus Management* 105, 325–346. <https://doi.org/10.1016/j.resconrec.2015.09.016>
8
9
10 818 Filali A., Bollon J., Fayolle Y., Gillot S.. Emissions de protoxyde d’azote par les procédés intensifs et
11 819 extensifs de traitement des eaux usées. Journées Information Eaux JIE, Oct 2016, Poitiers, France. 6 p.
12
13 820 hal-01467423
14
15 821 García-Gusano, D., Garraín, D., Dufour, J., 2017. Prospective life cycle assessment of the Spanish
16 822 electricity production. *Renew. Sustain. Energy Rev.* 75, 21–34.
17
18 823 <https://doi.org/10.1016/j.rser.2016.10.045>
19
20
21 824 Goedkoop, M.J., Heijungs, R., Huijbregts, M., De Schryver, A., Struijs, J., Van Zelm, R., 2009. ReCiPe
22 825 2008, A life cycle impact assessment method which comprises harmonised category indicators at the
23
24 826 midpoint and the endpoint level (First edition No. Report I: Characterisation).
25
26
27 827 Guest, J.S., Skerlos, S.J., Barnard, J.L., Beck, M.B., Daigger, G.T., Hilger, H., Jackson, S.J., Karvazy,
28 828 K., Kelly, L., Macpherson, L., Mihelcic, J.R., Pramanik, A., Raskin, L., Van Loosdrecht, M.C.M., Yeh,
29
30 829 D., Love, N.G., 2009. A New Planning and Design Paradigm to Achieve Sustainable Resource Recovery
31
32 830 from Wastewater. *Environ. Sci. Technol.* 43, 6126–6130. <https://doi.org/10.1021/es9010515>
33
34 831 Igos, E., Besson, M., Navarrete Gutiérrez, T., Bisinella de Faria, A.B., Benetto, E., Barna, L., Ahmadi,
35 832 A., Spérandio, M., 2017. Assessment of environmental impacts and operational costs of the
36
37 833 implementation of an innovative source-separated urine treatment. *Water Res.* 126, 50–59.
38
39 834 <https://doi.org/10.1016/j.watres.2017.09.016>
40
41
42 835 IPCC, 2018: Global Warming of 1.5°C. An IPCC Special Report on the impacts of global warming of
43 836 1.5°C above pre-industrial levels and related global greenhouse gas emission pathways, in the context
44
45 837 of strengthening the global response to the threat of climate change, sustainable development, and efforts
46
47 838 to eradicate poverty [Masson-Delmotte, V., P. Zhai, H.-O. Pörtner, D. Roberts, J. Skea, P.R. Shukla, A.
48 839 Pirani, W. Moufouma-Okia, C. Péan, R. Pidcock, S. Connors, J.B.R. Matthews, Y. Chen, X. Zhou, M.I.
49
50 840 Gomis, E. Lonnoy, T. Maycock, M. Tignor, and T. Waterfield (eds.)]. In Press.
51
52 841 IPCC, 2019. Wastewater treatment and discharge, in: 2019 Refinement to the 2006 IPCC Guidelines for
53
54 842 National Greenhouse Gas Inventories. IPCC, Switzerland.
55
56 843 Ishii, S.K.L., Boyer, T.H., 2015. Life cycle comparison of centralized wastewater treatment and urine
57
58 844 source separation with struvite precipitation: Focus on urine nutrient management. *Water Res.* 79, 88–
59
60 845 103. <https://doi.org/10.1016/j.watres.2015.04.010>
61
62
63
64
65

- 846 Islam, M.S., 2017. Comparative evaluation of vacuum sewer and gravity sewer systems. *Int. J. Syst.*
847 *Assur. Eng. Manag.* 8, 37–53. <https://doi.org/10.1007/s13198-016-0518-z>
- 848 Jefferson, B., Laine, A.L., Stephenson, T., Judd, S.J., 2001. Advanced biological unit processes for
849 domestic water recycling. *Water Sci. Technol. J. Int. Assoc. Water Pollut. Res.* 43, 211–218.
- 850 Jeong, H., Broesicke, O.A., Drew, B., Crittenden, J.C., 2018. Life cycle assessment of small-scale
851 greywater reclamation systems combined with conventional centralized water systems for the City of
852 Atlanta, Georgia. *J. Clean. Prod.* 174, 333–342. <https://doi.org/10.1016/j.jclepro.2017.10.193>
- 853 Jinming, D., Jingxuan, Z., 2006. Studies on frictional pressure drop of gas-non-Newtonian fluid two-
854 phase flow in the vacuum sewers. *Civ. Eng. Environ. Syst.* 23, 1–10.
855 <https://doi.org/10.1080/10286600500431904>
- 856 Jönsson, H., Burström, A., Svensson, J., 1998. Mätning på två urinsorterande avloppssystem (Report
857 No. 228). Uppsala.
- 858 Kavvada, O., Tarpeh, W.A., Horvath, A., Nelson, K.L., 2017. Life-Cycle Cost and Environmental
859 Assessment of Decentralized Nitrogen Recovery Using Ion Exchange from Source-Separated Urine
860 through Spatial Modeling. *Environ. Sci. Technol.* 51, 12061–12071.
861 <https://doi.org/10.1021/acs.est.7b02244>
- 862 Landry, K.A., Boyer, T.H., 2016. Life cycle assessment and costing of urine source separation: Focus
863 on nonsteroidal anti-inflammatory drug removal. *Water Res.* 105, 487–495.
864 <https://doi.org/10.1016/j.watres.2016.09.024>
- 865 Larsen, T.A., Gujer, W., 1996. Separate management of anthropogenic nutrient solutions (human urine).
866 *Water Sci. Technol.* 34, 87–94.
- 867 Larsen, T.A., Udert, K.M., Lienert, J. (Eds.), 2013. Source separation and decentralization for
868 wastewater management. IWA Publ, London.
- 869 Lesjean, B., Gnirss, R., 2006. Grey water treatment with a membrane bioreactor operated at low SRT
870 and low HRT. *Desalination* 199, 432–434. <https://doi.org/10.1016/j.desal.2006.03.204>
- 871 Maurer, M., Schwegler, P., Larsen, T.A., 2003. Nutrients in urine: energetic aspects of removal and
872 recovery. *Water Sci. Technol. J. Int. Assoc. Water Pollut. Res.* 48, 37–46.
- 873 Mbaya, A.M.K., Dai, J., Chen, G.-H., 2017. Potential benefits and environmental life cycle assessment
874 of equipping buildings in dense cities for struvite production from source-separated human urine. *J.*
875 *Clean. Prod.* 143, 288–302. <https://doi.org/10.1016/j.jclepro.2016.12.111>
- 876 Meinzinger, F., Otterpohl, R., Londong, J., 2010. Resource efficiency of urban sanitation systems: a
877 comparative assessment using material and energy flow analysis, *Hamburger Berichte zur*

878 Siedlungswasserwirtschaft. Ges. zur Förderung und Entwicklung der Umwelttechnologien an der
1 879 Techn. Univ. Hamburg-Harburg, Hamburg.

2
3
4 880 Merz, C., Scheumann, R., El Hamouri, B., Kraume, M., 2007. Membrane bioreactor technology for the
5 881 treatment of greywater from a sports and leisure club. *Desalination* 215, 37–43.
6
7 882 <https://doi.org/10.1016/j.desal.2006.10.026>

8
9
10 883 Monfront, L., 2009. Dimensionner les canalisations d’assainissement pour assurer leur performance
11 884 hydraulique. (Sewer design to insure hydraulic performance) (Rapport Etude & Recherche No. 158.E–
12 885 2), Les Editions du CERIB. CERIB, France.

13
14
15 886 Okun, D.A., Wang, L.K., Shammas, N.K., 2010. *Water Supply and Distribution and Wastewater*
16 887 *Collection*. John Wiley and Sons.

17
18
19 888 OtterWasser GmbH, 2009. Ecological housing estate, Flintenbreite, Lübeck, Germany (Case study of
20 889 sustainable sanitation projects), Sustainable Sanitation Alliance (SuSanA).

21
22
23 890 Peter-Fröhlich, A., Bonhomme, A., Oldenburg, M., 2007. Sanitation concepts for separate treatment of
24 891 urine, faeces and greywater (SCST) (Final report: EU-demonstration project No. Contract :
25 892 LIFE03ENV/D000025). KompetenzZentrum Wasser Berlin gGmbH.

26
27
28
29 893 Petit-Boix, A., Sanjuan-Delmás, D., Gasol, C.M., Villalba, G., Suárez-Ojeda, M.E., Gabarrell, X., Josa,
30 894 A., Rieradevall, J., 2014. Environmental Assessment of Sewer Construction in Small to Medium Sized
31 895 Cities Using Life Cycle Assessment. *Water Resour. Manag.* 28, 979–997.
32
33 896 <https://doi.org/10.1007/s11269-014-0528-z>

34
35
36 897 Remy, C., 2010. Life cycle assessment of conventional and source separation systems for urban
37 898 wastewater management. <https://doi.org/10.14279/depositonce-2370>

38
39
40 899 Roediger Vacuum, 2012. *Vacuum Sewer Systems Construction Manual*. Pipe laying and installation of
41 900 RoeVac® collection chambers and valves.

42
43
44 901 Shi, C.Y., 2011. *Mass Flow and Energy Efficiency of Municipal Wastewater Treatment Plants*. IWA
45 902 Publishing.

46
47
48 903 Skambraks, A.-K., Kjerstadius, H., Meier, M., Davidsson, Å., Wuttke, M., Giese, T., 2017. Source
49 904 separation sewage systems as a trend in urban wastewater management: Drivers for the implementation
50 905 of pilot areas in Northern Europe. *Sustain. Cities Soc.* 28, 287–296.
51
52 906 <https://doi.org/10.1016/j.scs.2016.09.013>

53
54
55
56 907 SQAÉ, 1994. *Assainissement des eaux usées dans les petites collectivités : techniques particulières de*
57 908 *collecte des eaux usées*. Volume 3 : Le réseau d’égouts sous vide. SQAÉ, Menviq, EAT Environnement.

58
59
60
61
62
63
64
65

909 Tervahauta, T., Bryant, I., Leal, L., Buisman, C., Zeeman, G., 2014. Improved Energy Recovery by
1 910 Anaerobic Grey Water Sludge Treatment with Black Water. *Water* 6, 2436–2448.
2
3 911 <https://doi.org/10.3390/w6082436>
4
5 912 Thibodeau, C., Monette, F., Bulle, C., Glaus, M., 2014a. Comparison of black water source-separation
6 913 and conventional sanitation systems using life cycle assessment. *J. Clean. Prod.* 67, 45–57.
7
8 914 <https://doi.org/10.1016/j.jclepro.2013.12.012>
9
10 915 Thibodeau, C., Monette, F., Glaus, M., 2014b. Comparison of development scenarios of a black water
11 916 source-separation sanitation system using life cycle assessment and environmental life cycle costing.
12
13 917 *Resour. Conserv. Recycl.* 92, 38–54. <https://doi.org/10.1016/j.resconrec.2014.08.004>
14
15 918 Tidåker, P., Mattsson, B., Jönsson, H., 2007. Environmental impact of wheat production using human
16 919 urine and mineral fertilisers – a scenario study. *J. Clean. Prod.* 15, 52–62.
17
18 920 <https://doi.org/10.1016/j.jclepro.2005.04.019>
19
20 921 Udert, K.M., Jenni, S. (Eds.), 2013. Biological nitrogen conversion processes, in: *Source Separation and*
21 922 *Decentralization for Wastewater Management*. IWA Publ, London.
22
23 923 Udert, K.M., Wächter, M., 2012. Complete nutrient recovery from source-separated urine by
24 924 nitrification and distillation. *Water Res.* 46, 453–464. <https://doi.org/10.1016/j.watres.2011.11.020>
25
26 925 van der Hoek, J., Duijff, R., Reinstra, O., 2018. Nitrogen Recovery from Wastewater: Possibilities,
27 926 Competition with Other Resources, and Adaptation Pathways. *Sustainability* 10, 4605.
28
29 927 <https://doi.org/10.3390/su10124605>
30
31 928 Vasilaki, V., Massara, T.M., Stanchev, P., Fatone, F., Katsou, E., 2019. A decade of nitrous oxide (N₂O)
32 929 monitoring in full-scale wastewater treatment processes: A critical review. *Water Research* 161, 392–
33 930 412. <https://doi.org/10.1016/j.watres.2019.04.022>
34
35 931 Vergara-Araya, M., Lehn, H., Poganietz, W.-R., 2020. Integrated water, waste and energy management
36 932 systems – A case study from Curauma, Chile. *Resour. Conserv. Recycl.* 156, 104725.
37 933 <https://doi.org/10.1016/j.resconrec.2020.104725>
38
39 934 Vinnerås, B., 2002. Possibilities for sustainable nutrient recycling by faecal separation combined with
40 935 urine diversion, *Acta Universitatis Agriculturae Sueciae Agraria*. Swedish Univ. of Agricultural
41 936 Sciences, Uppsala.
42
43 937 Vinnerås, B., Palmquist, H., Balmér, P., Jönsson, H., 2006. The characteristics of household wastewater
44 938 and biodegradable solid waste—A proposal for new Swedish design values. *Urban Water J.* 3, 3–11.
45 939 <https://doi.org/10.1080/15730620600578629>
46
47
48
49
50
51
52
53
54
55
56
57
58
59
60
61
62
63
64
65

940 Wilsenach, J.A., van Loosdrecht, M.C., 2006. Integration of Processes to Treat Wastewater and Source-
1 941 Separated Urine. *J. Environ. Eng.* 132, 331–341. [https://doi.org/10.1061/\(ASCE\)0733-
3 942 9372\(2006\)132:3\(331\)](https://doi.org/10.1061/(ASCE)0733-9372(2006)132:3(331))
4
5 943 Winker, M., 2013. Susana Forum: Roediger NoMix toilets - good or bad? And SANIRESCH final report
6 944 (urine diversion project with UD flush toilets and treatment reactors in Eschborn, Germany). available
7 945 at [https://forum.susana.org/urine-diversion-flush-toilets/3406-roediger-nomix-toilets-good-or-bad-and-
8 946 saniresch-final-report-urine-diversion-project-with-ud-flush-toilets-and-treatment-reactors-in-
9 947 eschborn-germany?start=12.](https://forum.susana.org/urine-diversion-flush-toilets/3406-roediger-nomix-toilets-good-or-bad-and-saniresch-final-report-urine-diversion-project-with-ud-flush-toilets-and-treatment-reactors-in-eschborn-germany?start=12)
10
11
12
13
14 948 Winward, G.P., Avery, L.M., Frazer-Williams, R., Pidou, M., Jeffrey, P., Stephenson, T., Jefferson, B.,
15 949 2008. A study of the microbial quality of grey water and an evaluation of treatment technologies for
16 950 reuse. *Ecol. Eng.* 32, 187–197. <https://doi.org/10.1016/j.ecoleng.2007.11.001>
17
18
19
20 951 Xue, X., Hawkins, T., Schoen, M., Garland, J., Ashbolt, N., 2016. Comparing the Life Cycle Energy
21 952 Consumption, Global Warming and Eutrophication Potentials of Several Water and Waste Service
22 953 Options. *Water* 8, 154. <https://doi.org/10.3390/w8040154>
23
24
25
26 954 Zhang, J., Xie, M., Tong, X., Liu, S., Qu, D., Xiao, S., 2020. Recovery of ammonium nitrogen from
27 955 human urine by an open-loop hollow fiber membrane contactor. *Sep. Purif. Technol.* 239, 116579.
28 956 <https://doi.org/10.1016/j.seppur.2020.116579>
29
30
31
32
33
34
35
36
37
38
39
40
41
42
43
44
45
46
47
48
49
50
51
52
53
54
55
56
57
58
59
60
61
62
63
64
65

1
2
3
4
5
6
7
8
9
10
11
12
13
14
15
16
17
18
19
20
21
22
23
24
25
26
27
28
29
30
31
32
33
34
35
36
37
38
39
40
41
42
43
44
45
46
47
48
49
50
51
52
53
54
55
56
57
58
59
60
61
62
63
64
65