



**HAL**  
open science

## Controlling the rheology of a solid emulsion with phase-changing droplets

Elina Gilbert, Anniina Salonen, Christophe Poulard

► **To cite this version:**

Elina Gilbert, Anniina Salonen, Christophe Poulard. Controlling the rheology of a solid emulsion with phase-changing droplets. *European Colloid & Interface Society* 35, Sep 2021, Athènes, Greece. hal-03339317

**HAL Id: hal-03339317**

**<https://hal.science/hal-03339317>**

Submitted on 9 Sep 2021

**HAL** is a multi-disciplinary open access archive for the deposit and dissemination of scientific research documents, whether they are published or not. The documents may come from teaching and research institutions in France or abroad, or from public or private research centers.

L'archive ouverte pluridisciplinaire **HAL**, est destinée au dépôt et à la diffusion de documents scientifiques de niveau recherche, publiés ou non, émanant des établissements d'enseignement et de recherche français ou étrangers, des laboratoires publics ou privés.

# Controlling the rheology of a solid emulsion with phase-changing droplets

Elina Gilbert<sup>1</sup>, Anniina Salonen<sup>1</sup> and Christophe Poulard<sup>1</sup>  
<sup>1</sup>LPS, Université Paris-Saclay, Orsay, France  
 elina.gilbert@universite-paris-saclay.fr

## Motivation

Emulsions are interesting systems whose rheological properties depend on the continuous and dispersed phases and the interface between them. By solidifying the continuous phase around the dispersed phase, we can create a composite viscoelastic material that can be tuned by changing the moduli of both the dispersed phase and the continuous phase, and/or the surface properties.

→ Viscoelastic composite with decorrelated storage and loss moduli?

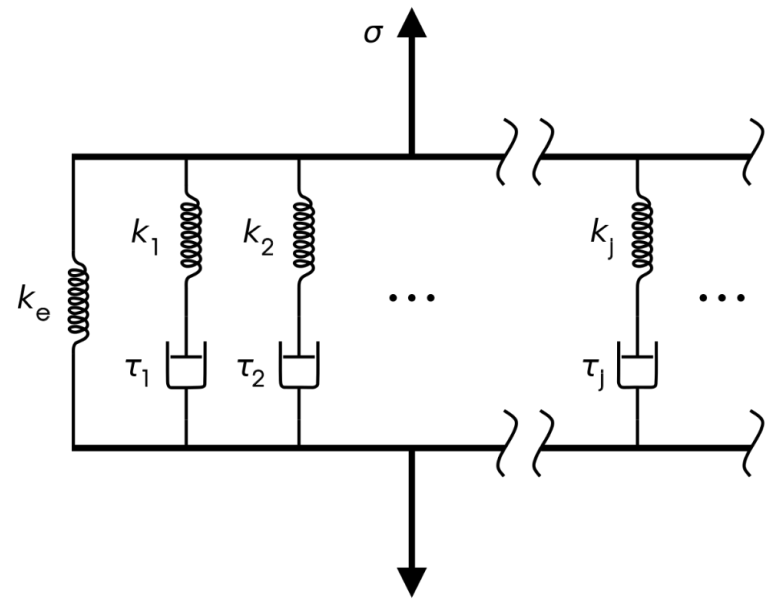

Glue photo by Babi Hijau  
Public Domain

By Pekaje at English Wikipedia - Transferred from en.wikipedia to Commons., Public Domain

## Sample generation

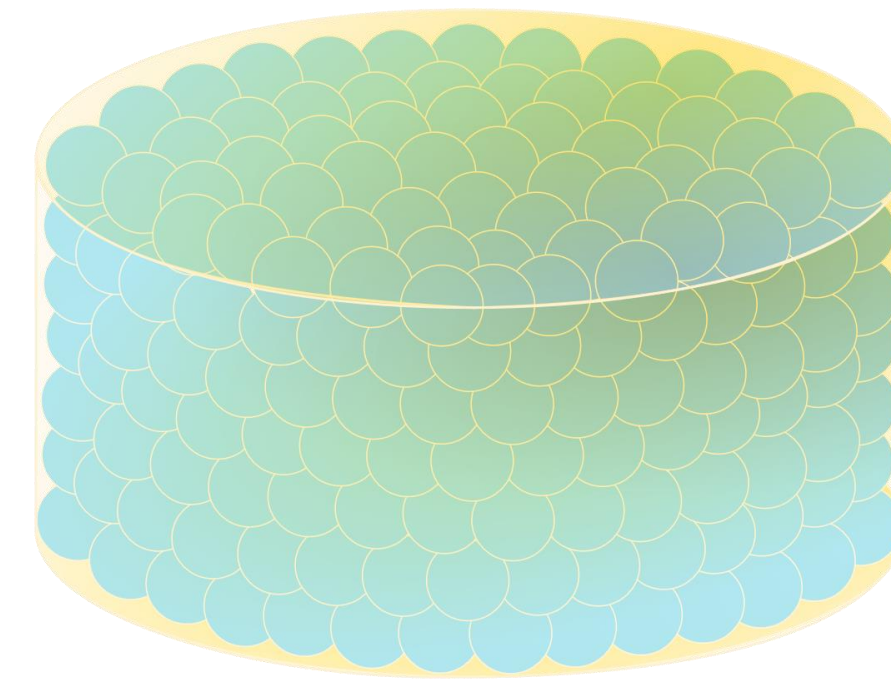

« polymer emulsion »

- Solid **continuous phase**, elastic (PDMS)
- Liquid **dispersed phase**, Newtonian fluid (PEG)

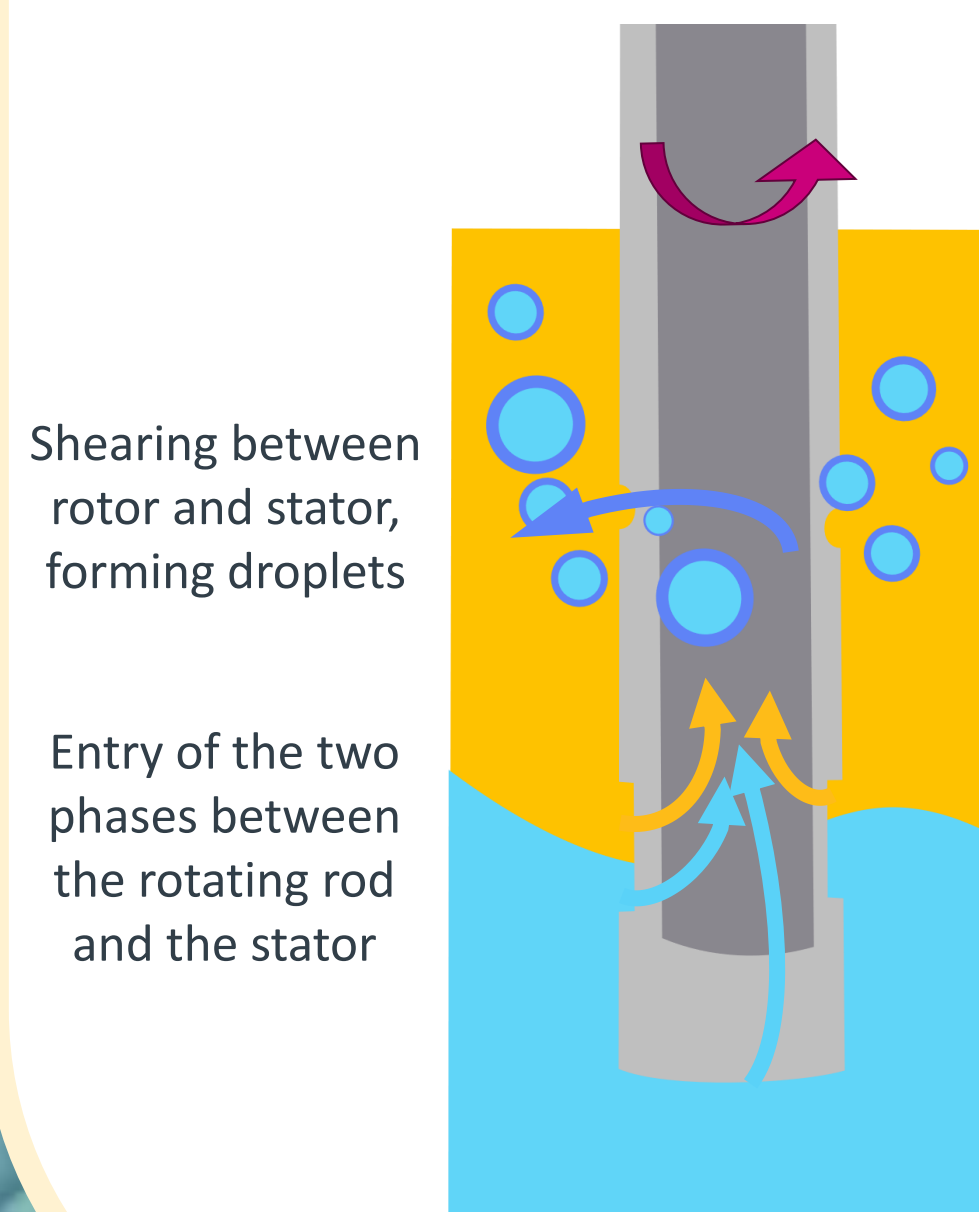

Generation by breakup under shear (control over the volume fraction  $\Phi$ )

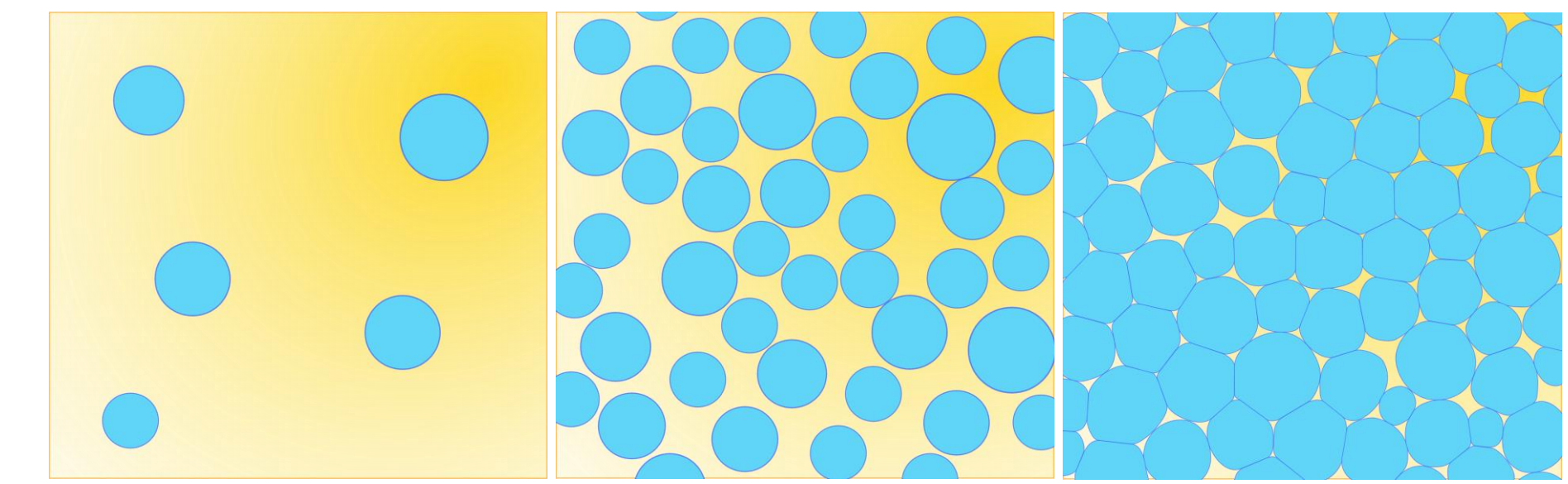

0,3      0,6  
Volume fraction of dispersed phase

## Frequency sweep

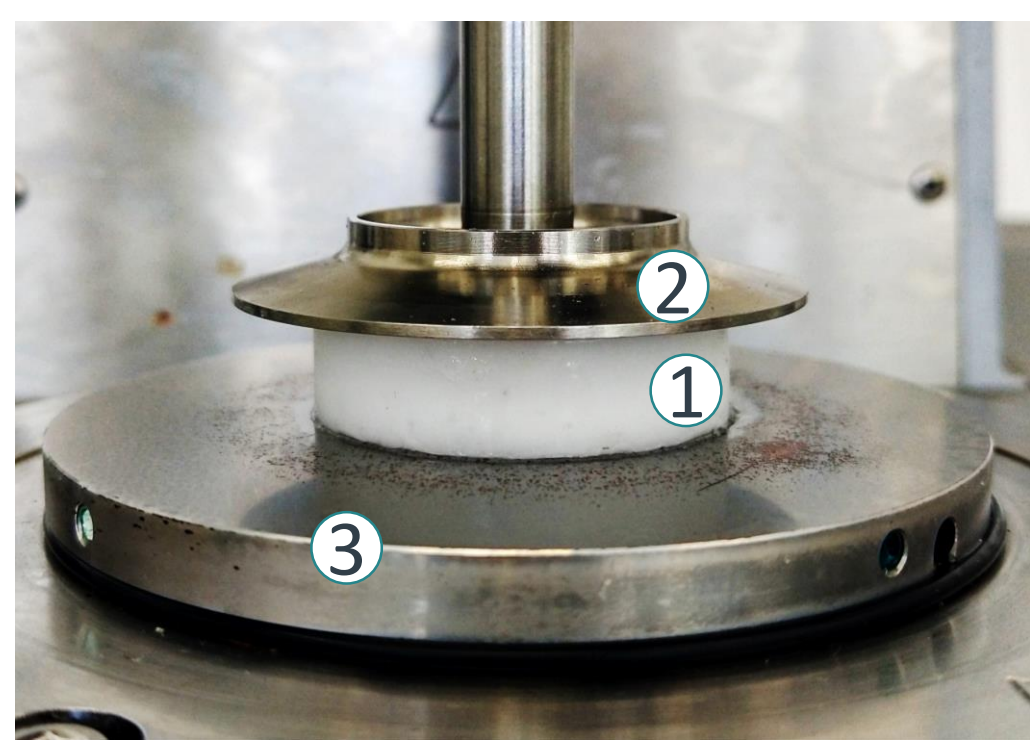

1. Sample, fixed to the rheometer with a layer of crosslinked PDMS
2. Rotating plane measuring system
3. Peltier plate for temperature control

Example of moduli measurement at a given volume fraction and temperature

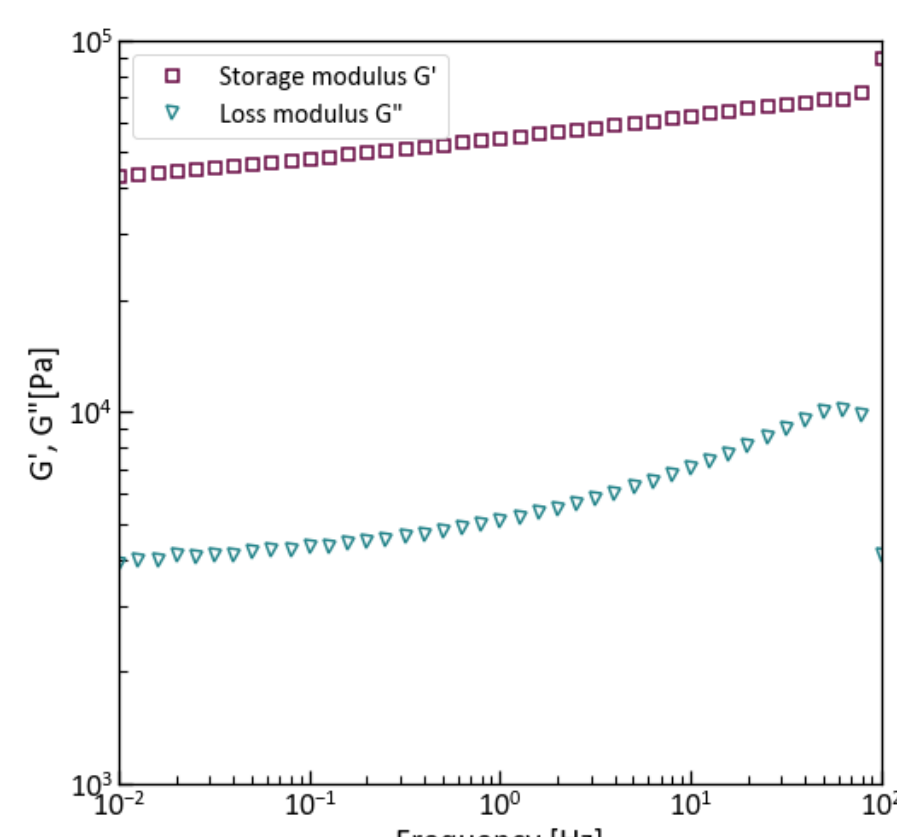

Modulus of the continuous phase  
 Complex modulus of the composite  
 $G^* = f(G_c^*, G_d^*, \sigma, R, \Phi)$   
 Surface tension  
 Modulus of the dispersed phase  
 Average droplet radius  
 Volume fraction

## Playing with the moduli

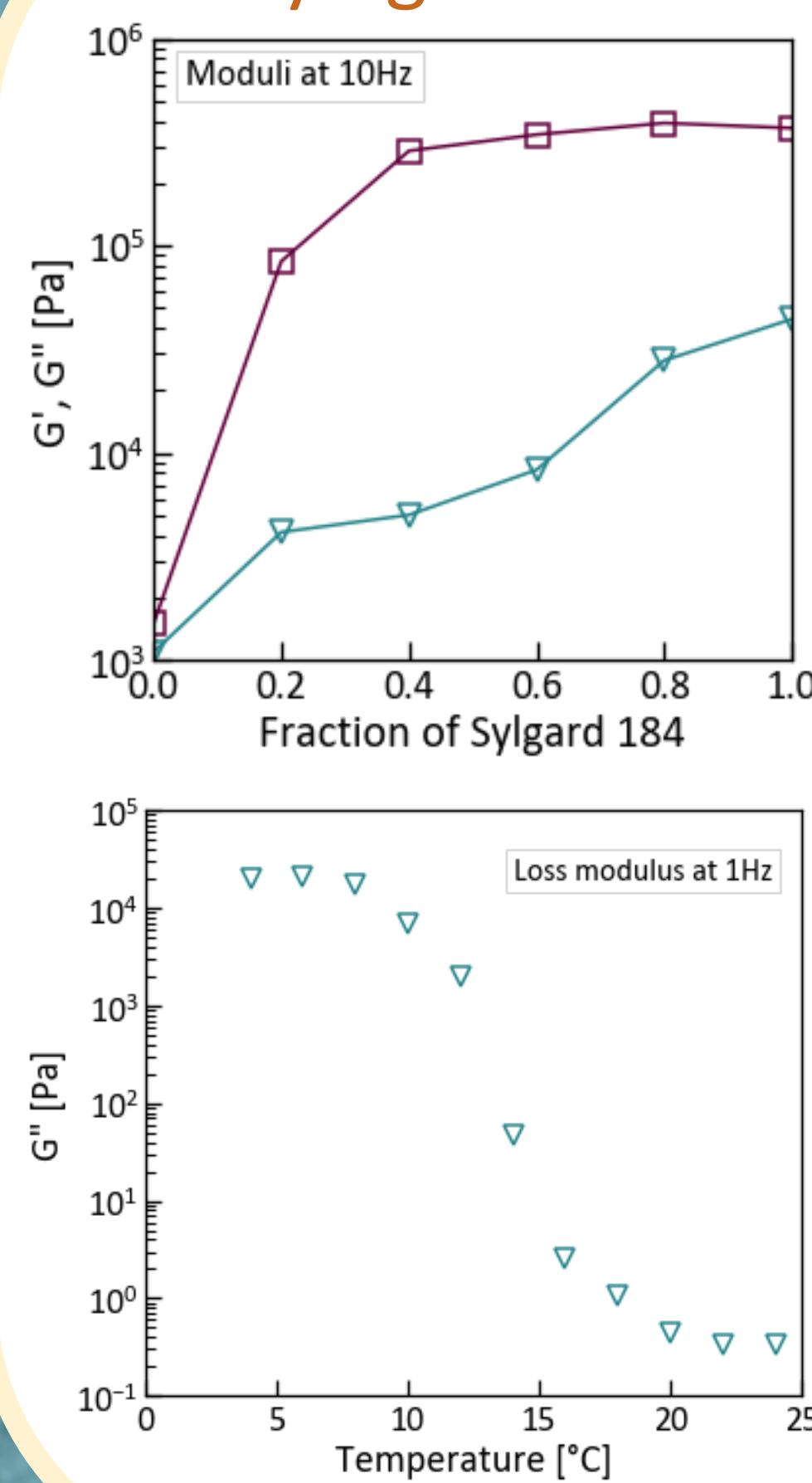

## Sample stabilization

Surfactant: block copolymer

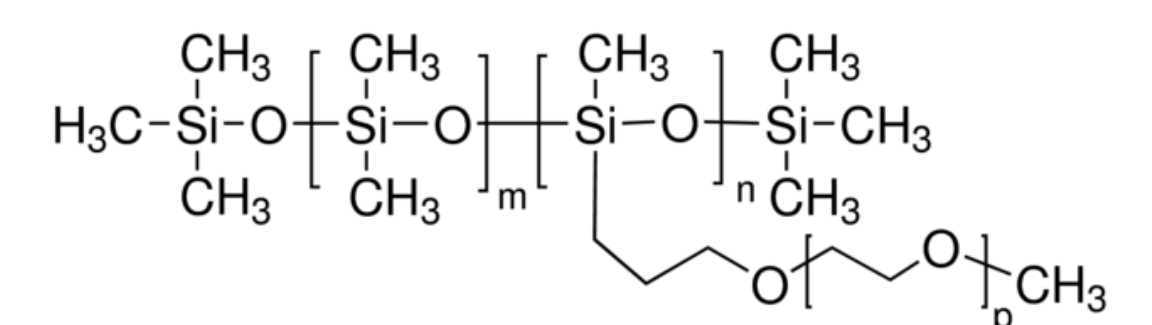

Formation of unstable cocontinuous phase for  $\Phi > 60\%$

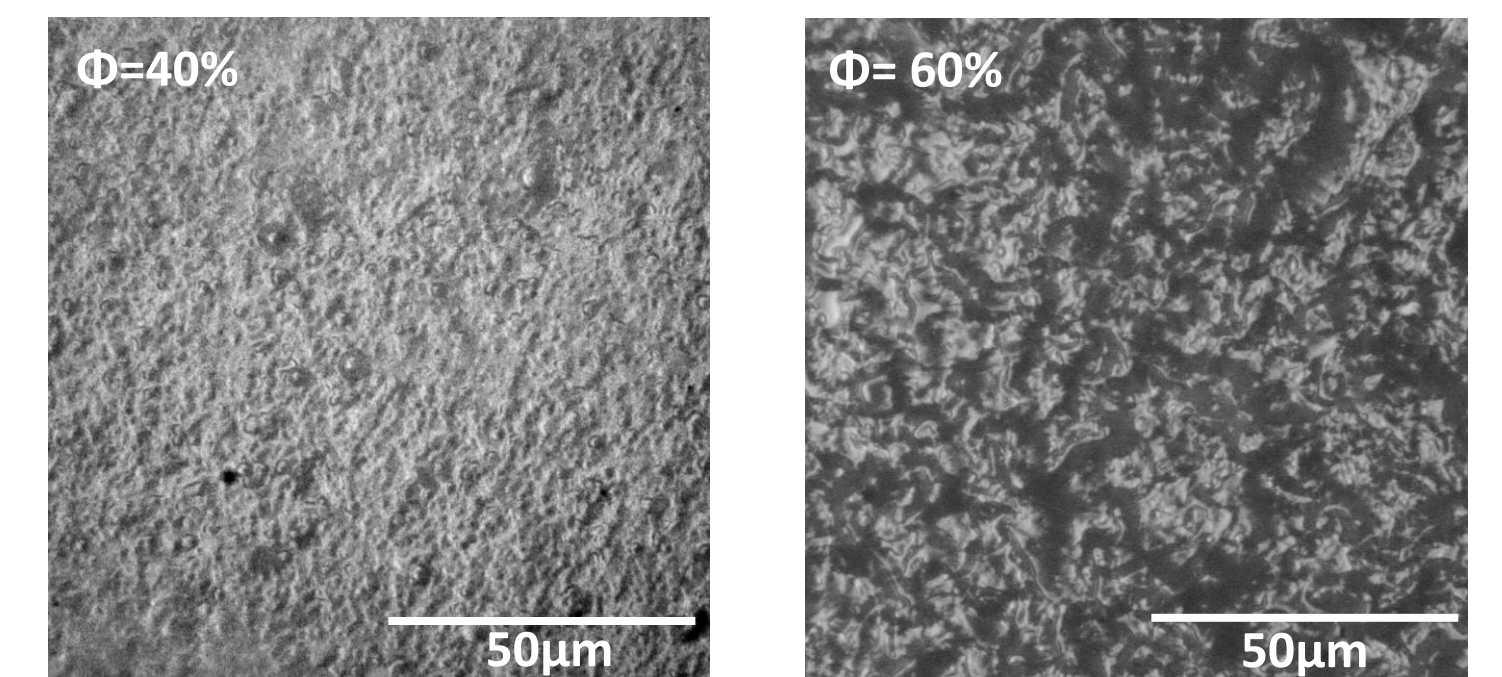

## Dependency on volume fraction and temperature

Decorrelation of storage and loss moduli at low volume fractions

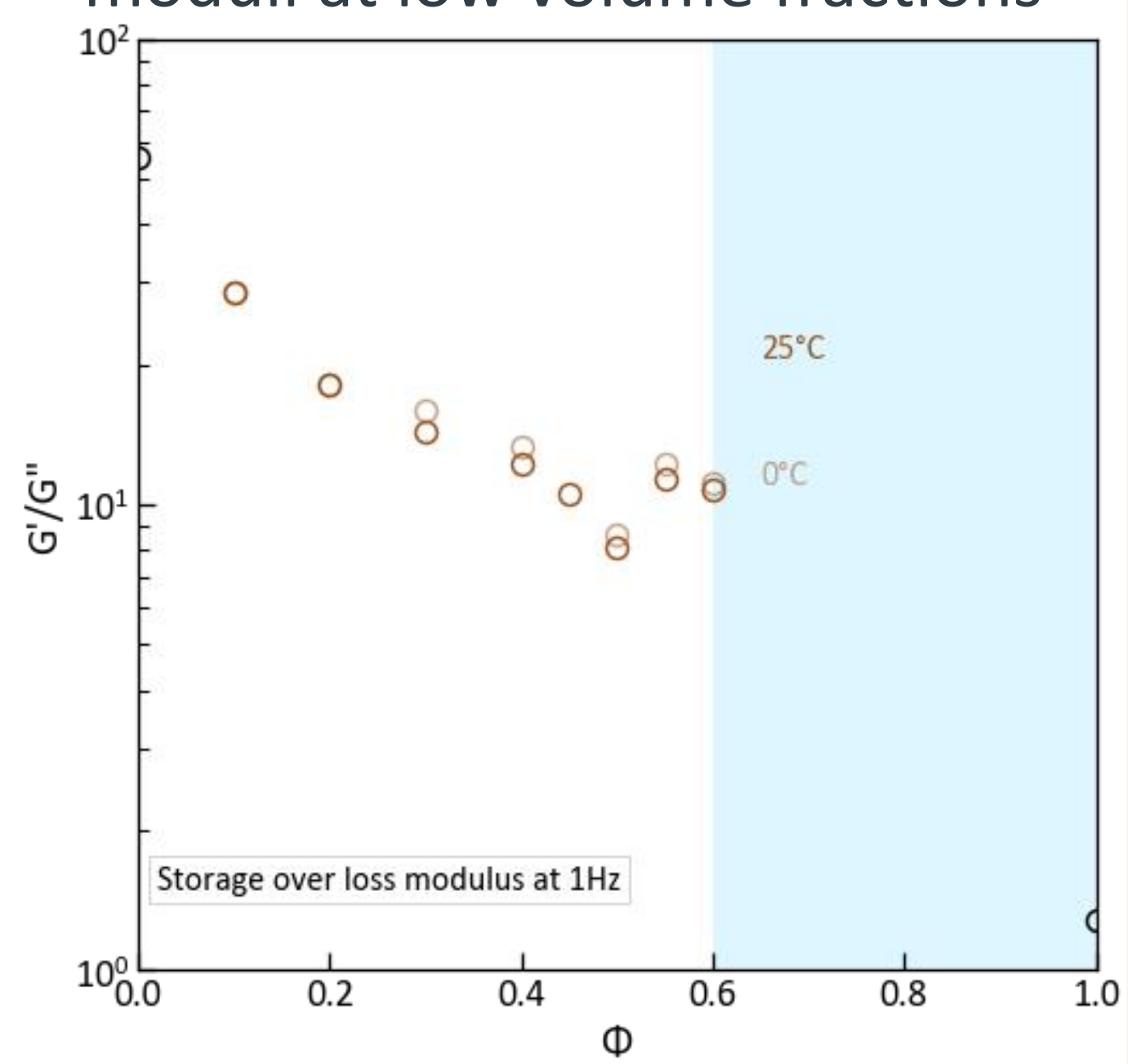

Moduli for a concentrated composite at 25°C (darker colors) and 0°C (lighter colors)

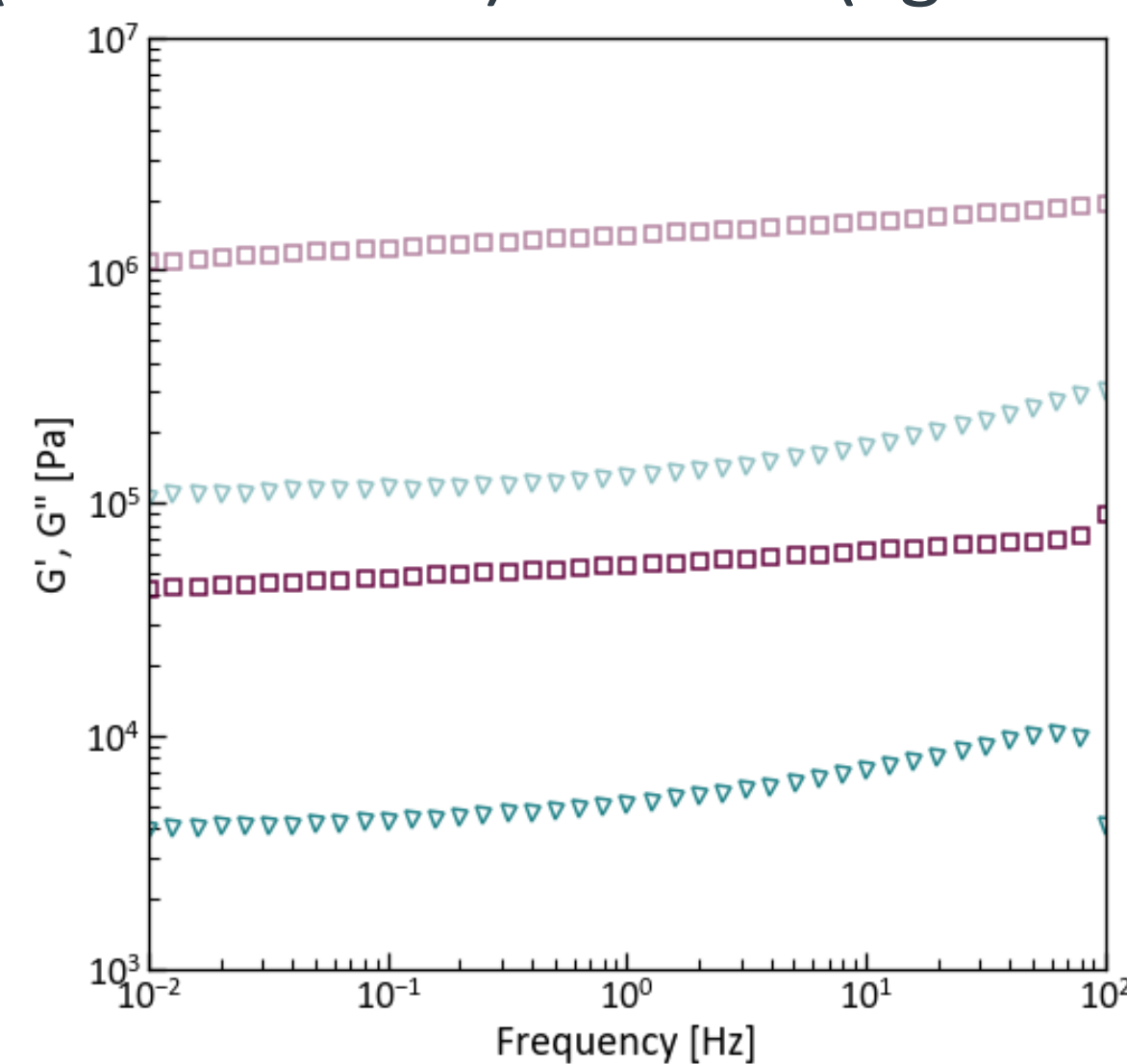

At low temperature (crystallized dispersed phase) Krieger-Dougherty like increase of the moduli with the volume fraction

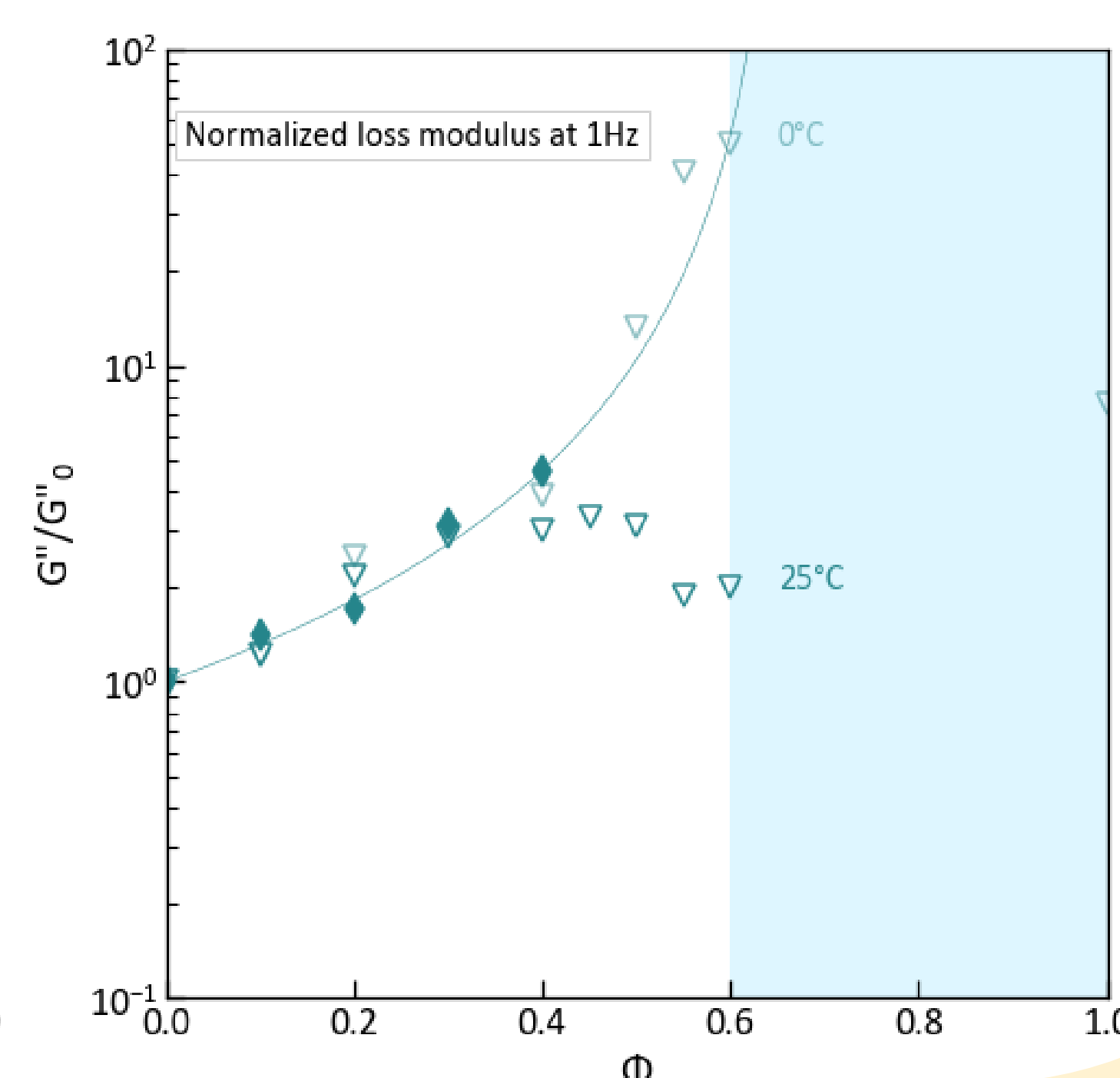
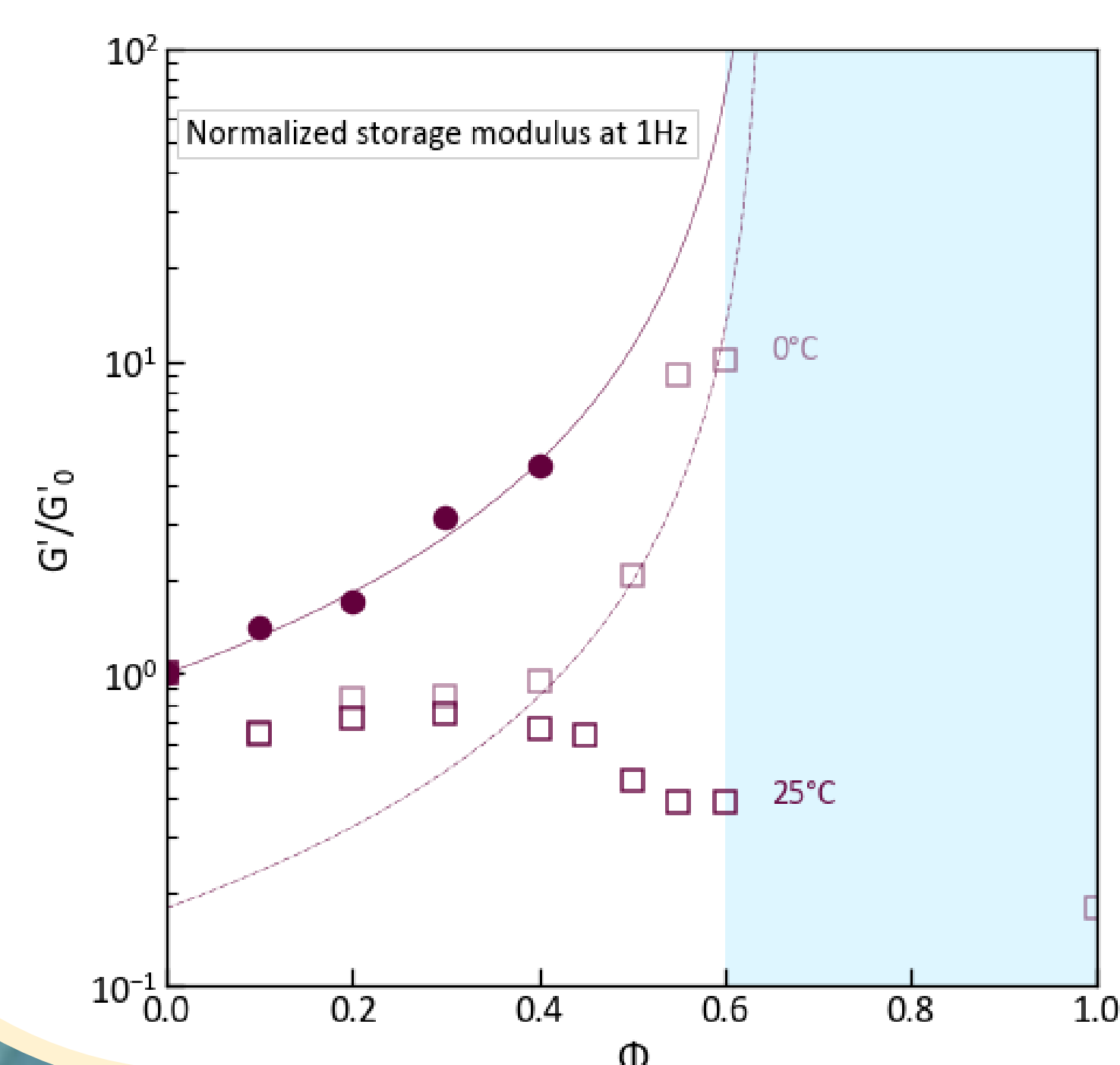

## Conclusion & Perspectives

- Strong influence of the dispersed phase on the loss modulus: apparent decorrelation of loss and storage moduli at low to middle volume fraction
- Crystallization of the dispersed phase shows unexpected behavior of the samples

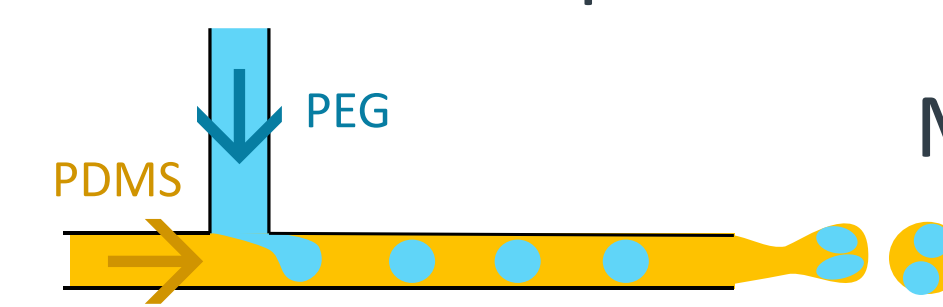

Microfluidic generation for control of the radius

Reactive interface for stabilization at  $\Phi > 60\%$

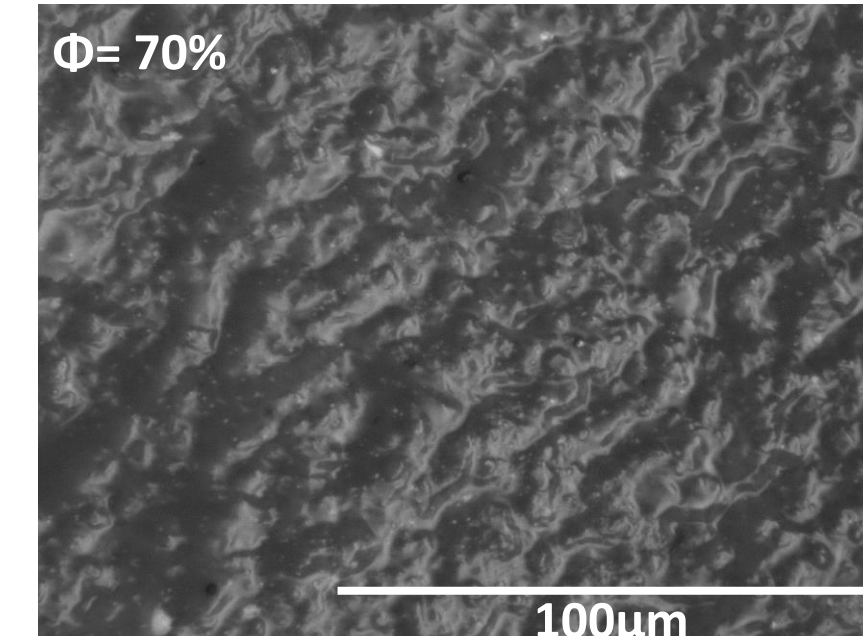

Complex liquids for the dispersed phase

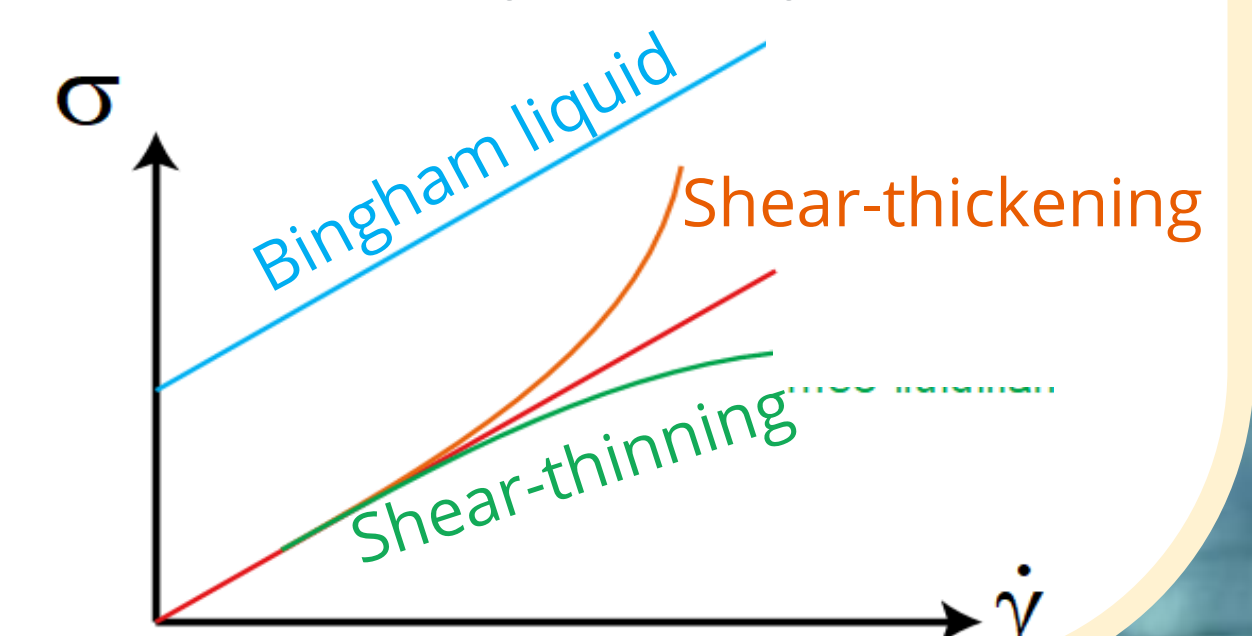

## References

- I. M. Krieger et T. J. Dougherty, « A Mechanism for Non-Newtonian Flow in Suspensions of Rigid Spheres », *Transactions of the Society of Rheology*, vol. 3, no 1, p. 137-152, **1959**, doi: 10.1122/1.548848
- J. F. Paliere, « Linear rheology of viscoelastic emulsions with interfacial tension », *Rheologica Acta*, vol. 29, no 3, p. 204-214, **1990**, doi: 10.1007/BF01331356.
- L. A. Utracki, « On the viscosity-concentration dependence of immiscible polymer blends », *Journal of Rheology*, vol. 35, no 8, p. 1615-1637, **1991**, doi: 10.1122/1.550248.
- U. Sundararaj et C. W. Macosko, « Drop Breakup and Coalescence in Polymer Blends: The Effects of Concentration and Compatibilization », *Macromolecules*, vol. 28, no 8, p. 2647-2657, **1995**, doi: 10.1021/ma00112a009.
- R. Pal, « Rheology of simple and multiple emulsions », *Current Opinion in Colloid & Interface Science*, vol. 16, no 1, p. 41-60, **2011**, doi: 10.1016/j.cocis.2010.10.001.