



HAL
open science

The Qalhât Development Project. First season: January 21st-April 21st 2013. Final Report of Excavations at Buildings B19, B20, B21 and B94

Magalie Dartus, Axelle Rougeulle, Daniel Etienne, Fabien Lesguer, Corinne Gosset, Apolline Vernet, H el ene Renel, Gulsu Simsek, Herv e Monchot

► **To cite this version:**

Magalie Dartus, Axelle Rougeulle, Daniel Etienne, Fabien Lesguer, Corinne Gosset, et al.. The Qalh at Development Project. First season: January 21st-April 21st 2013. Final Report of Excavations at Buildings B19, B20, B21 and B94. [Research Report] CNRS; Ministry of Heritage and Culture (Sultanat d'Oman); Eveha International. 2014. hal-03336924

HAL Id: hal-03336924

<https://hal.science/hal-03336924v1>

Submitted on 7 Sep 2021

HAL is a multi-disciplinary open access archive for the deposit and dissemination of scientific research documents, whether they are published or not. The documents may come from teaching and research institutions in France or abroad, or from public or private research centers.

L'archive ouverte pluridisciplinaire **HAL**, est destin ee au d ep ot et  a la diffusion de documents scientifiques de niveau recherche, publi es ou non,  emanant des  tablissements d'enseignement et de recherche fran ais ou  trangers, des laboratoires publics ou priv es.

The Qalhât Development Project

First season : January 21st – April 21st 2013

- "Final Report of Excavations at Buildings B19, B20, B21 and B94"

- Vol. 1 -



Magalie Dartus (Éveha)

Daniel Étienne (Éveha), Fabien Lesguer (Éveha), Corinne Gosset (Éveha),
Apolline Vernet (Éveha), Hélène Renel (CNRS - Umr 8167),
Dr Gülsü Simsek (Labex MiChem, CNRS – UMR7075),
Dr Hervé Monchot (Labex Resmed, UMR 8167 “Orient & Méditerranée”)

and

Dr Axelle Rougeulle (CNRS - Umr 8167)



Sultanate of Oman
Ministry of Heritage & Culture



سُلْطَنَة عُومَان
وَنَزَارَة الْبَرَاءَة وَالثَّقَافَة



The Qalhât Development Project
First season : January 21st – April 21st 2013

**" Final Report of Excavations at Buildings B19,
B20, B21, B94 "**

- Vol. 1 -

Magalie Dartus (Éveha)

Daniel Étienne (Éveha), Fabien Lesguer (Éveha), Corinne Gosset
(Éveha), Apolline Vernet (Éveha), Hélène Renel (CNRS - UMR
8167), Dr Gülsü Simsek (Labex MiChem, CNRS – UMR 7075), Dr
Hervé Monchot (Labex Resmed, UMR 8167 “Orient &
Méditerranée”)

and

Dr Axelle Rougeulle (CNRS - UMR 8167)

Ministry of Heritage & Culture

P. O. Box 668 – P. C. 100

Muscate,

Sultanate of Oman

CNRS- Umr 8167

Orient & Méditerranée

27 rue Paul Bert

94204 Ivry-sur-Seine

France

umr8167@ivry.cnrs.fr

Éveha International

24 avenue des Bénédictins

87000 Limoges

France

contact@eveha-

international.com

The first season of excavations of the Qalhât Development Project (QDP) took place from January 21st to April 21st 2013. The expedition was held under the authority of the Ministry of Heritage and Culture (MHC) of the Sultanate of Oman, with the financial support of the MHC and of the French National Centre for Scientific Research (CNRS) for the participation of various specialists. It was directed by Dr Axelle Rougeulle, from the CNRS – UMR 8167, "Orient & Méditerranée", and realized on the field by a team from Éveha, a French archaeological consulting agency specialized in contract archaeology and heritage development, under the direction of Mrs Magalie Dartus.

Members of the team were:

Dr Axelle Rougeulle (CNRS - UMR 8167, Paris), archaeologist, scientific director of the Qalhât Development Project, director of the excavation component,

Magalie Dartus (Éveha), archaeologist, field director.

Daniel Etienne (Éveha), archaeologist, assistant field director.

Corinne Gosset (Éveha), archaeologist.

Fabien Lesguer (Éveha), archaeologist

Apolline Vernet (Éveha), archaeologist.

Hélène Renel (CNRS - UMR 8167, Paris), ceramologist, registration and study of the material.

Dr Gülsü Simsek (Labex MiChem, CNRS - UMR 7075, University Pierre et Marie Curie, Paris) chemist, chemical analysis of the material, ceramics and glass.

Dr Hervé Monchot (Labex ResMed, CNRS - UMR 8167, Paris), archaeozoologist, study of the mammal bones.

Our deepest thanks are due to the Ministry of Heritage and Culture of the Sultanate of Oman for its strong involvement in the Qalhât Development Project. Our gratitude goes especially to H.E. Salim bin Mohammad Al Mahruqi, Undersecretary for Heritage Affairs, to Mr Hassan Mohammad Ali al-Lawati, Director General for Archaeology and Museums, to Sultan Saif Nasser al-Bakri, Director of the Department of Excavations and Archaeological Studies, and to Mr Khamis Nasser al-‘Amri, representative of the Department in the Sur region, for their very efficient and friendly help and support all along the expedition.

The main object of the season was to excavate extensively and clear completely a part of the northwest quarter of the city, several buildings around a small square, and prepare the conservation work for display to the public in the future archaeological park.



Fig.1_Location of Qalhât

1. Qalhât

Qalhât is one of the most famous and impressive archaeological sites of the Sultanate of Oman, a huge ruin field 35ha wide, all that is left of a main Omani harbour city of the Middle Ages. It is located near the city of al-Sûr, c. 50km north of the Ra's al-Hadd in the Sharqiya Province (fig.1).

Qalhât was a main harbour of the Indian Ocean but was little documented in texts. According to an Omani tradition, it already existed in the beginning of the Christian era, when Mâlik ibn Fahm, the mythic king of the 'Azd tribe is reported to have migrated from Hadramawt to Oman. The country was at that time under Persian occupation and the 'Azd are reported to have left their properties at the village of Qalhât before defeating the Persians in a battle at Salût near Nizwa. Mâlik would have then founded one of his capital cities at Qalhât (Bhacker MR & Bhacker B 2004: 25-26). Another tradition mentions that a later migration headed by Muhammad Dirhem-Koh sailed from Qalhât in the 11th century, to Iran where it founded the Hormuzi kingdom. Dirhem-Koh built "in that port a city, inasmuch as it was a place suitable for those of the country to trade with the ships that passed that way", leaving his son as a governor (Teixeira & Sinclair 1902: 153-155, 256-257).

This last tradition is more in accordance with Yaqût al-Rûmî, who visited Oman in the beginning of the 13th century and reported that Qalhât was a recent city, founded around 500 H. i.e. around the beginning of the 12th century AD (Yaqût 1868, iv: 393). In any case, Qalhât is first mentioned in texts around the middle of the 12th century, especially by al-Idrisî around 1150 (fig.2), and the harbour was mainly famous in the 13th to 15th centuries, when it became the second capital of the kingdom of Hormuz which at that time dominated most of the trade routes in the Western Indian Ocean. It was one of the main ports of Oman and of the Islamic world, the emporium of Indian goods, the main centre for the export of Arab horses, as well as the lock of the Gulf of Oman (Polo 1980, ii: 498-499).

One of the most famous characters in the history of Qalhât was Ayâz, the governor of the city who became the ruler of the Hormuz kingdom at the end of the 13th century. He conducted many naval battles and was the one who decided in 1300 to move Hormuz from the Mînâb mainland (old Hormuz) to the Jarun island (new Hormuz), a stroke of genius which made the fortune of Hormuz. His wife Maryam, who ruled Qalhât in his absence, built a mausoleum which is the only edifice still standing on the site, one of the most famous tourist spots in the region (fig.3).

The harbour was supplanted by Muscat as the chief port of Oman in the 15th

صُورَةُ الْأَرْضِ لِلشَّرِيفِ الْإِدْرِيسِيِّ لِثَوْنِي سَنَةِ ٥٦٠ هـ

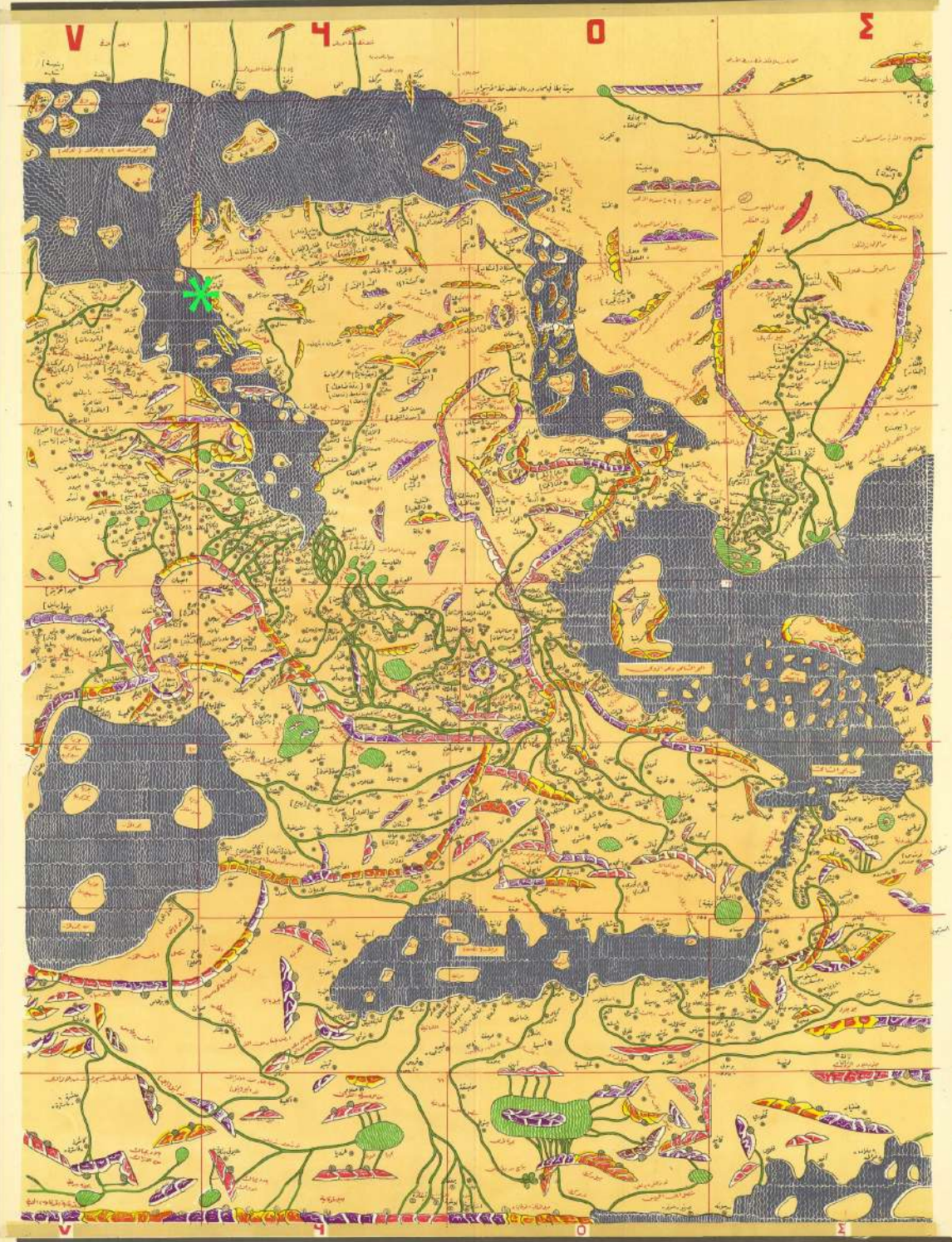

جمع أجزاء هذه الخريطة من قبل الشريف الإدريسي في سنة ١١٥٠ م، وأعادها إلى أمهها المرموقة بحفرة الأندلس بعد هجرته إلى الأندلس، وقد ساعد في تصحيحها وتصويرها بمسورة من كتاب
 نسخة المشتاق فاضل الأقاليم وراعي دولة المغرب العربي، وهو ما استند إليه المستشرق المذكور من مخطوطات الإدريسي في كتابه «الجزيرة الإسلامية» في سنة ١٣٢٠ هـ - ١٩٠٧ م. مطبعة دار الجمهورية - أشراف مكتب مطبع
 وضع المجمع العلمي العراقي الطبعة الأولى في سنة ١٣٧٠ هـ - ١٩٤١ م بمطبعة مديرية المساحة العامة وأعادها ونسختها الهندس في العراق طبعها في سنة ١٣٢٠ هـ - ١٩٠٧ م. مطبعة دار الجمهورية - أشراف مكتب مطبع

Fig.2_Qalhat on Idrisi's map,
 around 1150

century and was probably damaged by an earthquake in the end of the 15th (Bhacker MR & Bhacker B 2004: note 44). However, it was still one of the main coastal cities of Oman when the Portuguese sacked it in 1508 (de Albuquerque 1874, i: 64-66, 221). It subsequently became a station for the Portuguese fleet and was definitely abandoned at the end of the 16th (Bhacker MR & Bhacker B



Fig.3_The mausoleum of Bibi Maryam

2004: 19, 39). It was never reoccupied nor pillaged for stones or anything else and the medieval city therefore lies untouched under its ruins, as a unique testimony of the past of Oman.

2. The Qalhât Project (QP, 2008-2012)

Despite its importance in Oman history and heritage, Qalhât had been little studied in the past and the Ministry of Heritage and Culture (MHC) of the Sultanate therefore decided in 2007 to start an important research project at the site in the final aim to create an archaeological park, in cooperation with a French team. After a preliminary visit in 2007 by Dr A. Rougeulle of the French National Centre for Scientific Research (CNRS) at the invitation of the MHC, and after the subsequent agreement of the CNRS and the Archaeological Committee of the French Ministry of Foreign Affairs (MAE), the Project started in 2008 and five seasons were conducted until 2012. The Qalhât Project was thus

an Omani-French project of archaeological study of the site of Qalhât. It was directed by Dr Axelle Rougeulle (CNRS - UMR8167, Paris) under the authority of the MHC and jointly financed by the MHC, the CNRS and the MAE. Supports were also granted by the French archaeological agency EVEHA which collaborated to the excavations since 2008, and by the Total Company which financed the Cartographical Project held at the site. These excavations brought quite a lot of information on Qalhât (see reports 2008-2012).

History

Excavations gave a rather clear idea of the general history of the city. The earliest occupation is dated to around 1100, a dating in accordance with Yaqut's and Turan Shah's assessments. No trace was found of a pre-Islamic occupation which could confirm the legend of Malik b. Fahm. During the 12th-13th centuries the town was rather small, limited to the central quarter near the beach although the actual fortifications were built in the beginning of the 13th, probably in 1218 according to Ibn al-Mujâwir. The city underwent a main development in the end of the 13th century and especially under the reign of Ayâz and Bibi Maryam (c. 1285-1320): a new large Friday Mosque was built at that time, together with a large official residence, and the peripheral quarters were then founded. The expansion of trade activities was clearly quite important, together with the growth of population. Traces were found which seem to confirm the reality of the 1497 earthquake mentioned in Egyptian chronicles and the notation by Portuguese that the inhabitants of Qalhât were rebuilding their city at the time of their arrival. The mosque in particular was recently restored at that time and some houses were inhabited by squatters. Although the texts mention the rapid decline of the city after its destruction in 1508, some buildings were still inhabited until the second half of the 16th century. But no trace of the 17th century was found and the city was totally abandoned at the end of the 16th.

The cartographical project, spatial organization of the city

One of the main objects of the Qalhât Project was to get information about the plan of the city as it was during its main period of occupation in the 14th-15th centuries, from surface survey and study. This Cartographical Project was realized by two specialists from the CNRS, thanks to a special funding of the French Total Company. A detailed cartographical survey of the surface with a GPS produced a preliminary map (fig.4) and 3D models of the medieval city, which will be completed later from the results of further excavations and surveys. The town focused on a central quarter, located along the beach/harbour and centred on the Great Mosque and an important official building which could be the residence of the governor. Wide peripheral quarters surround it to the north, west and south, with craft activities and large buildings, houses and stores, organized along streets or around squares. To the west was the funerary quarter, with many graves and funerary structures. The city was enclosed and protected by impressive fortification walls with towers and several gates, and two look-out posts were standing on the mountain overlooking the harbour and coastal road. Beside two cisterns, the water supply was mostly provided by wells in the Wadi Hilm.



Fig.4_Preliminary plan of the medieval city in the 14th-15th centuries according to the results of the Cartographical Project

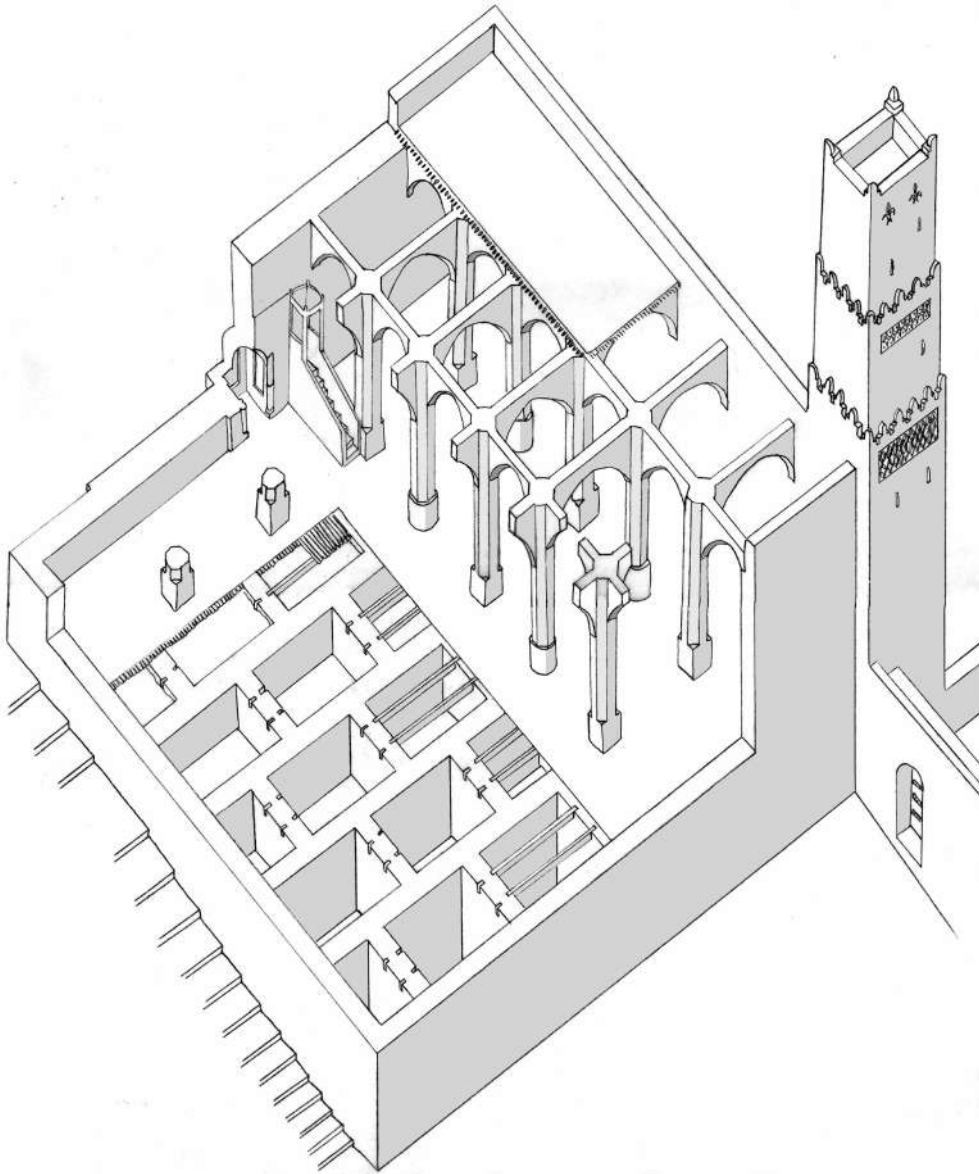

Fig.5_Tentative restitution of the Great Mosque of Qalhât (built c.1300 A.D.) according to the results of the 2008-2011 excavations

Main buildings, the great mosque and the residence

Excavations were made in several buildings, the residence, large houses and stores, one small mosque on a platform, a ceramic factory, the cisterns and the fortifications. But the main improvement of the Qalhât Project was the discovery and excavation of the Great Mosque of Qalhât which was discovered near the beach during the preliminary visit in 2007. This mosque was a very impressive building, 25 x 27m, with five naves and six bays, which was erected on a massive basement 5m high (fig.5). Altogether the building must have been more than 10m high on the seaside and a tall minaret was standing at the north-east

corner. As described by Ibn Battuta and Bras de Albuquerque it was highly decorated, and several pieces of Iranian Kashan glazed tiles with lustre and cross-and-star bleu glazed tiles of probable local origin were found. Two courtyards at different levels, limited by a retaining wall, were located north and west, accessible from the city side and the beach.

Ceramics, trade and society

Excavations at Qalhât delivered a huge amount of material, especially ceramics. A detailed study of that ceramics is in progress, the local production as the many imported wares, on the typological, technological and historical point of view. More than dating, it also allows reconstructing the degree of technical ability of the local craftsmen, the social organization of the population and its daily life, the varied commercial networks of the harbour. Besides ceramic imports, many characteristics of the site also confirm the cosmopolitan character of the city.

3. The Qalhât Development Project (QDP, 2013 sq)

In the context of the expansion of infrastructures and tourism in Oman and especially in the region of Sûr (fig.6), a development project was planned at Qalhât since the beginning of the Qalhât Project in 2008. The French mission



Fig.6_The new highway Sûr-Quriyat at the edge of the site

was originally supposed to take over the scientific study only, but the MHC quickly asked the mission to take care also of the development aspect of the Project (2009), and then of the conservation part of it (2011). Several preliminary drafts of a management plan were conceived during this period. Finally, proposals for a large five-year Development Project entitled “The Qalhât Development Project. Excavation, Conservation and Tourism Development of the archaeological site of Qalhât, Sultanate of Oman”, was sent to the MHC at its request in April 2012, under the scientific direction of Dr Axelle Rougeulle from the CNRS-UMR8167 Orient & Méditerranée. The official agreement of the MHC about the Excavation and Conservation Components of the Project was received end of July 2012, the Tourism Development component postponed to a later date.

Two field missions are planned each season, about 3 months each, one in October-December and one in January-March with Christmas holidays in-between. Six archaeologists and several specialists will take part to the Excavation Component, under the direction of Dr A. Rougeulle, one heritage architect and one site supervisor to the Conservation Component, under the direction of Mr P. Blanchard and the World Monument Fund. 40 workers will be needed for the Excavation Component, 5 craftsmen and 15 workers for the Conservation Component. The first season of the Excavation Component took place this winter/spring, a short 3 months season from January 21st to April 20th 2013.

The main objective of this season was to excavate part of the north-west quarter, several buildings around squares. Three buildings were totally cleared, the twin houses B94, the large building B21 and the small platform mosque B19.

B 94, earliest building and twin houses

Building B94 is located in the north-western quarter of the ancient city of Qalhât (fig.7), just south of building B21 (infra). It was already partly excavated during the fourth season of the Qalhât Project, in 2011, when the general plan was cleared and soundings opened in all the rooms and outside to have an evaluation of the stratigraphy and the history of the building.



Fig.7_Location of B94

This year, the first season of the Qalhât Development Project had the objective to excavate and clear the building extensively (fig.8), to complete the data about its plan, function and chronology and prepare it for conservation and display to the public.



*Fig.8_General view
of B94*

1. Earliest Building

This season confirms the existence of a previous building under the one visible on the surface. As a matter of fact, several structures were found on the bedrock and sometimes in a backfill, under the floors in several rooms of the later building (fig.9).

- Under room 94D :

During this early phase, irregularities in the bedrock were levelled by a backfill (UF2647-2648, UF1654, UF2603). Then a series of postholes was dug in the bedrock (ST153, ST151, ST152, ST150, ST148, ST149, ST145, ST142). According to the ceramic this phase could be a 14th century occupation.

- Under room 94R :

The first phase of construction in this area is a floor built on a layer levelling the bedrock (UF1723). This floor is associated with a wall (ST052), both coated with the same grey mortar.

The floor is running under the south wall (ST007) and west wall (ST004) of room B94R. A small sounding on the other side of this west

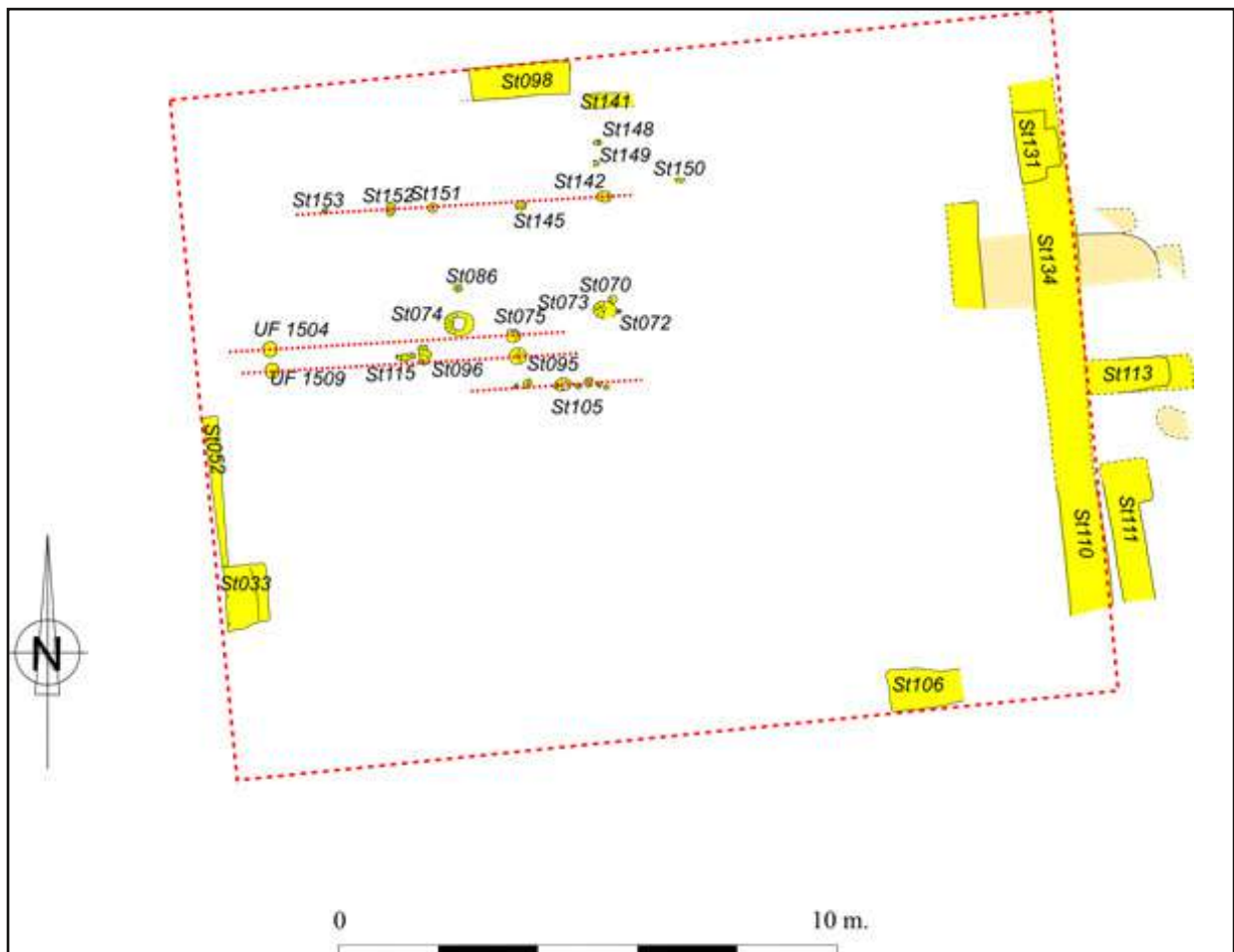

Fig.9_Plan of the vestiges of the early building under B94, second half of the 13th-first half of the 14th century A.D.

wall shows that the early floor is extending in this direction (UF1950), but we cannot determine its maximal extent.

Even though some elements show that there was a restructuring in the initial plan of the house, the same former floors and wall are still in used before the abandonment of the earliest building.

- Under room 94I :

Many traces of occupation related to the earlier building were found in this area, and especially postholes which were probably linked to a grinding activity (see annexe artefacts).

Directly dug in the bedrock, at least eight postholes were discovered, but not necessary linked together.

Two of them (ST096, ST115) are so close that we cannot really say they were working together and we don't really know their function. In fact ST96 is rather made of three post-holes combined in one with only one digging.

Three other postholes seem to have been linked somehow (ST070, ST072, ST073). As for "postholes", we should rather give another

explanation. The hypothesis the most valuable is that ST073 could be a fitting to receive a grinding stone. And the other two holes could have been used to place posts in order to maintain the grinding stone's base. The general idea is somehow an installation for grinding stone have been used at this place, probably in the same period of the postholes, then everything was cleaned and backfilled.

None of those structures was associated to a floor; except for UF 1769 which could either be a floor trace (less probably) or the last layer of a pit filling. This could indicate that everything has somehow been cleaned out before setting up the later surface.

Furthermore, this occupation seems to belong to the earliest house. Indeed, it appears that the layers UF 1793 and UF 1994 are sealed by the wall ST 013 installation. The same situation is visible for the layers UF 1997/1815, UF 1998/1816 and UF 1999.

- Under room 94M :

This phase is characterized by a layer of leveling of the bedrock (UF 1492), of two north / south directed walls (ST 039 and ST 040) (fig 10) and of a layer of occupation (UF 1489).

Walls ST 039 and ST 040 are parallels and spaced out of 0,20m. They are directly both built on the bedrock and only 10cm are preserved. After a backfill (UF 1492) is settled to level the bedrock. It consists of a very dry and compact orange-coloured, clayey sediment mixed with small pebbles. This layer have been observed on the East and on the West both walls. It would seem that this layer was also a ground, the layer (UF 1489) is directly put on. It consists of one sooty earth with a thickness of 0,05m. This layer seems to correspond to the occupation of the early building. It was not observed at the east of the wall ST 040. The inside of the building would be on the West of the wall ST 039. This last one is coated on its western facing.

Both walls, layer of leveling and layer of occupation cross under the foundations of the walls of the room M what proves their anteriority.

- Under room 94P :

The level covering the bedrock (UF 2592 and UF 2586) and passing under the walls ST 021 and ST 018 is undoubtedly prior to the construction of the walls and so reasonably related to the older occupation. On the south-eastern corner of the room, a small remain of a floor (UF 2597) made of strong grey mortar goes under the wall ST 018 and is probably the same floor as the one found outside the room. Also probably, the two levels (UF 1912 and UF 1913, which are probably the same), over which was built the wall ST 113, might be the

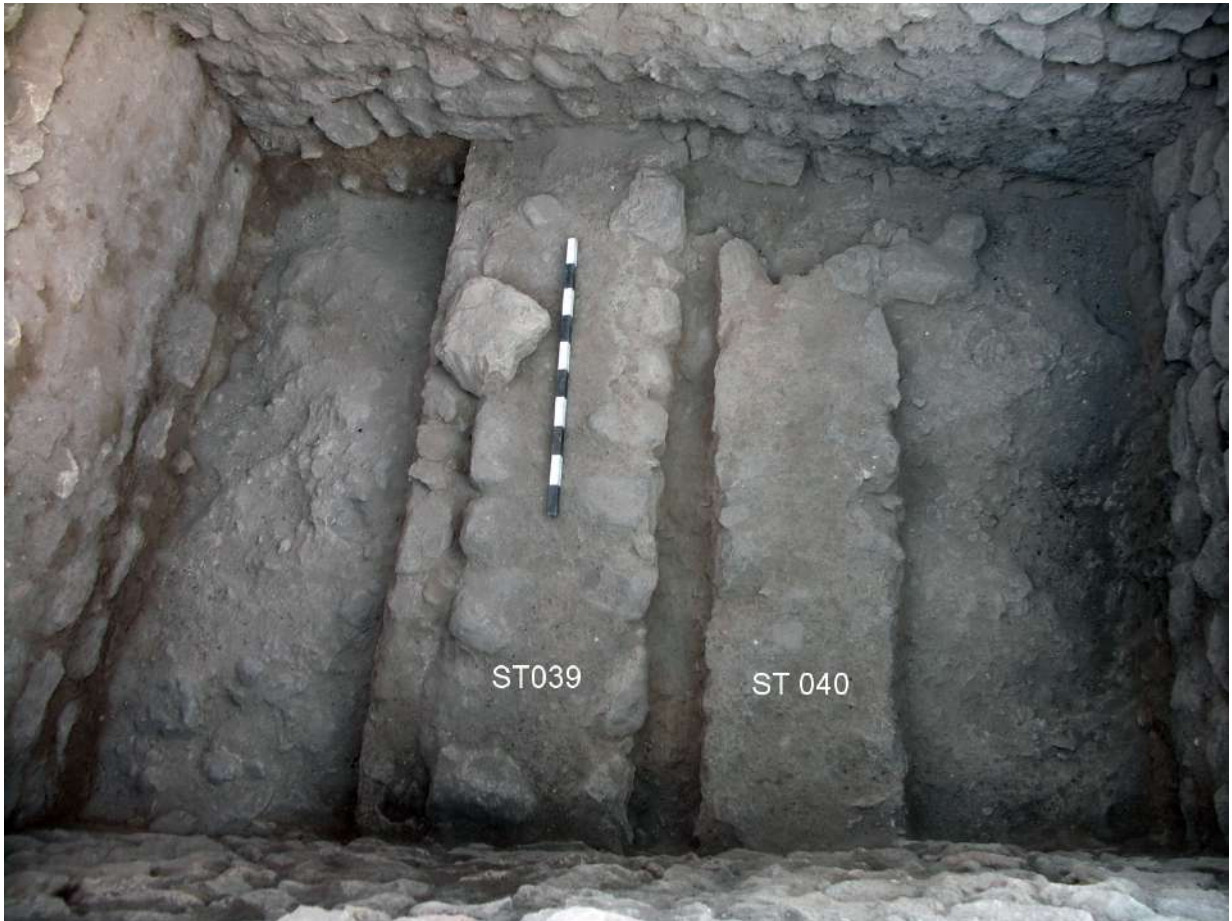

Fig.10_general view of room B94M

levels of this older occupation. And with no other evidence that it was visibly cut by the construction of the wall ST018, the aforementioned wall ST 113 could be possibly linked with that phase.

The early occupation is more obvious in the north-eastern corner (fig.11) . The wall ST 134, which is probably the same as one (ST 039) of those found in the room M and certainly the same as the one (ST 131) found outside north of the wall ST 017, is part of this occupation and works quite certainly with the lower black coated part of the wall ST 019. Between those two walls stood probably a floor, also made of black coating, but it was destroyed by later refitting. The wall ST 134 is also connected, on its eastern side, to a floor (UF 2598) made of strong mortar. The edges of these floors are marked, on the northern and eastern sides, by a small step suggesting the former presence of walls which were entirely destroyed. Few stones are also visible along those edges and can be interpreted as the last remains of a recovered wall (ST 135) over which the wall ST 018 was partially built. The space occupied by the former wall ST 135 is mainly covered by a level of ashes and charcoal (UF 2596), especially around the north-eastern corner of the room, where found, in a small cavity of the bedrock, a small unfired pottery filled with ashes and a small metal tip, covered with a piece of fired pottery. This unusual laying might indicate the



*Fig.11_early occupation
in room B94P*

place of a hypothetical threshold, if it is assumed that all those constructions belong to a prior building.

- Exterior West :

The most ancient floor in this area (UF 1950) is a compact earth level lying directly on the bedrock or on the backfill, depending of the topography of the bedrock. It runs under the west wall (ST 004) and under the south wall of B94 (ST 007). It seems to correspond to the floor discovered in room R in association with the oldest wall (ST 052, supra). This floor therefore belongs to the first building.

- Exterior East :

Several floors were discovered east of house B94. The older one (UF 2600), made of strong grey mortar, has partially been observed in the south-eastern and south-western parts of the sounding, and shows a visible edge that can be interpreted as the traces of a destroyed wall which would have been roughly parallel with the three former walls ST 110-131-134. The floor and its edge are covered by a level (UF 2621) made of charcoals and ashes, showing some similarity with the observations made on the construction prior to the house B94 observed in the north-eastern corner of the room P, so it can be concluded that this floor belongs to the same early phase as the walls ST 134 and ST 135 and floor UF 2595, but without any real proof.

- Outside structure :

Structure 106_1 is located of the outside angleof rooms M and Q.

The first construction is made of a course of square stones standing on a filling of packed earth levelling the bedrock (UF 1978) (fig.12) . Above it there is an occupation layer consisting of packed earth with chalk and charcoal (UF 1971).

Fig.12_the outside structure during the early phase (ST 106_1)

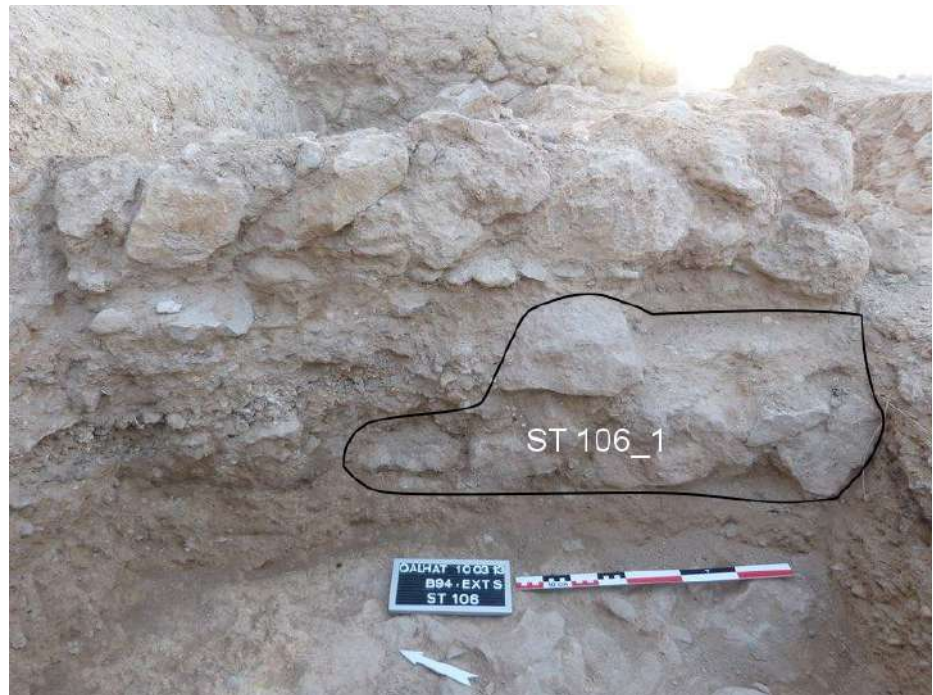

2. The Twin Houses

The main occupation phase in this area is a large building whose ruins were clearly visible on the surface. As already stated excavations started here in 2011. Most of the collapse layer was then removed and the general plan of the construction was revealed. Six rooms were completely cleared (A, H, J, K, L and M), and soundings opened in the others rooms and outside, to have an evaluation of the stratigraphy and the history of the building (see Qalhât Project 2011 report).

This year, the objective was to clear extensively the building (fig.13), excavating all intern area and part of the surroundings to complete the data from the 2011 mission. Concerning the occupation of the house, this season brought much information about the function of the rooms and courtyards (D and I) and confirmed that the building was made of two contiguous houses without communication between them (fig.14).

1.1 The Northern House

The northern house measures about 16m east-west and 8m north-south.



*Fig.13_general view of B94
from the north-western
corner*



Fig.14_final plan of B94

It is accessible through a door 1.60m wide which is located at its eastern extremity, near the corner with the room P (fig.15) .

This house had six rooms in the ground floor, and probably some more

Fig.15_the gate to the northern house



in the first floor. The entrance room (F) includes a staircase to reach to the second floor. Crossing this room, there is an access to a courtyard (D), a little store (C) and a workplace (A). Two little rooms were built in a second time, outside of the house, probably a shop (J) and a store (K). Five main architectural phases were determined during the excavations. The first one is dated to the end of 13th century or beginning of the 14th century, the last one to the 16th century. This dating was defined by the preliminary study of the pottery.

PHASE I (fig.16)

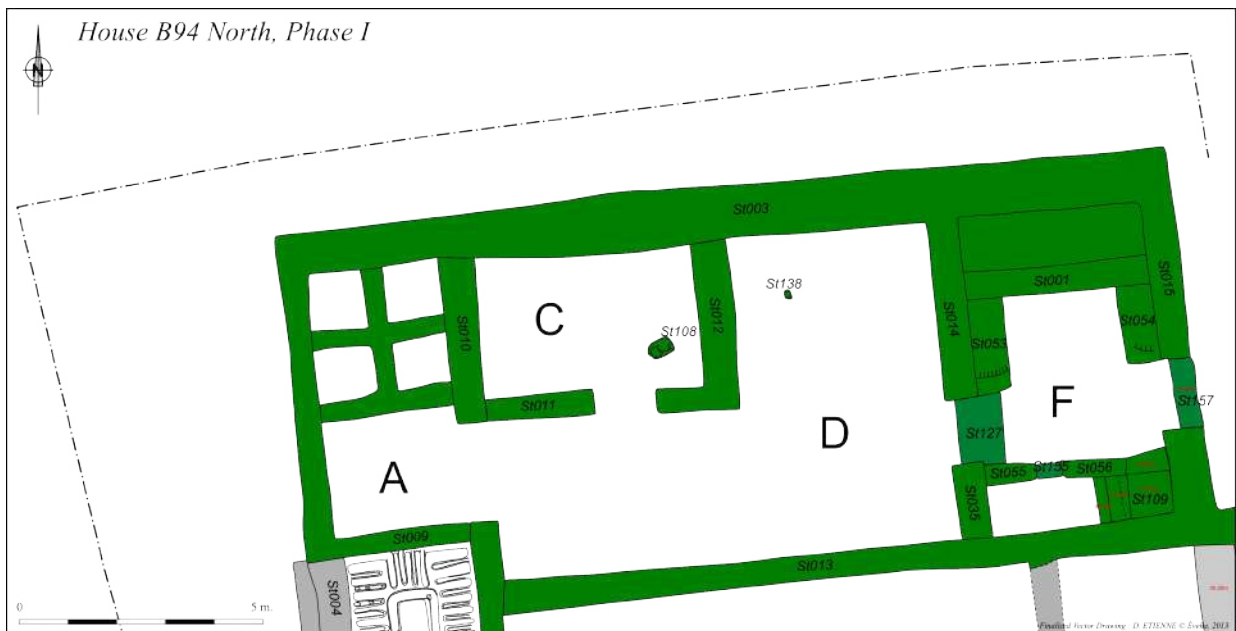

Fig.16_plan of the Northern House during phase I

- Room F :

The gate to the northern house was leading to an entrance room (F) which measures 6.5m north-south and 4m east-west (fig.17), i.e. an area of 26m². Nearly opposite, in the west wall, is a second door leading to a courtyard (D, see infra).

South of this passage, straight to the left of the gate in the south-east corner of the room, is a staircase in two perpendicular flights (ST 109)



Fig.17_general view of room B94F

leading to the first floor. Four steps built in stones, coral and wood are now preserved,, and six beam prints inside the south wall show the presence of further steps upstairs The staircase has a width of 1 m and rises to 3 m in height, which also gives the higher of the floor. Steps have 31 cm of height on average, the two first steps are 40 cm high. The space under the upper flight of stairs was closed by a thin wall of 50 cm (to make a small closet, of 2 m², with a narrow door of 60 cm width (ST 013).

To the right of the passage, two benches 60cm wide and 80cm high (ST 053, ST 054), covered with a strong coating, were located against the east and west walls of the entrance room. They have an armchair on their south side along the jambs of the doors, and they abutted to the north against a cistern (ST 001) 1.20m wide which was occupying the

entire northern extremity of the room, i.e. 4m large. This cistern was coated inside by a strong cement and was limited by a small wall 30cm wide and 1m high; its maximum capacity was therefore about 4.5m³. At the foot of the wall of the cistern, 1.40m far from the west wall of the room, a post-hole 15cm deep and 20cm in diameter was set in the cemented floor; it was probably part of a system to draw water out.

- Courtyard D :

Opposite the gate of the house, in the western wall of the entrance room, a second door, 1.30m wide, was leading to room D, most probably a courtyard as the volume of the collapse layer suggests that it was not roofed. It has a L shape, 9.40 m long east-west and 3.20 m to 6.50 m wide north-south, altogether 44 m² in area. Only one structure is dating back to this first phase, it's a post-hole (ST 138) 20 cm in diameter and 10 cm deep which is located to the north-west of the courtyard.

- Room C :

The room C is a small square room, 5 x 3,5 m, located in the northwest



*Fig.18_irregular
bedrock in room B94C*

corner of the courtyard, with a door 1.30 m wide in its south wall (fig.18) .

The surface of the bedrock was very irregular under this room, with a deep natural hole to the south, and, although no trace of the early building was found there, a thick layer of backfill was laid to fill the hole and level the surface before the construction of the original floor of the room. This backfill (UF1437) includes many small pebbles/gravel and few medium sized stones, with a lot of pottery sherds as well as some illegible coins and half part of a cornelian



Fig.19_Cornaline archer ring from the construction backfill in room 94C, phase I

archer ring (fig.19), all of them mixed with a brown and soft earth. Just above, UF1444 also contain a lot of ceramic associated with small fragments of limestone mixed with a brown and compact earth. The floor (UF1426) is a homogeneous layer made of beaten soft and light brown sediment including few small pebbles, at at ca. 29 m 60 maximum.

There was a hearth (ST 108) in this floor (UF 1839) which is dated by the preliminary study of the associated ceramics covering the surface to around the 14th century.

- Room A :

This room is located at the western end of the courtyard and house, accessible by the threshold identified in the survey B94D1 (D1 : sounding made in 2011). It measures 2.80 x 5.30 m, i.e. 14.80m² (fig.20). The walls are of varying thickness, 50 to 90cm, built of mixed materials and preserved up to about 2.50 m. They are associated with a floor built directly on the bedrock at 29.82 rating, solid coating, and four shallow square basins were built in the northern part of the room, about 1m² in area and 60 cm deep each, separated by low walls (1 m high).



*Fig.20_general
view of room B94A*

PHASE II (fig.21)

- Room F :

This phase is a period of renovation of the entrance room. A new mortar (UF2571) was laid everywhere on the floor and benches and a layer of stones filled the cistern (ST001) which was sealed by a strong mortar, thus now transformed into a small platform. The closet under the staircase was still there Between the wall ST055 and ST056, there

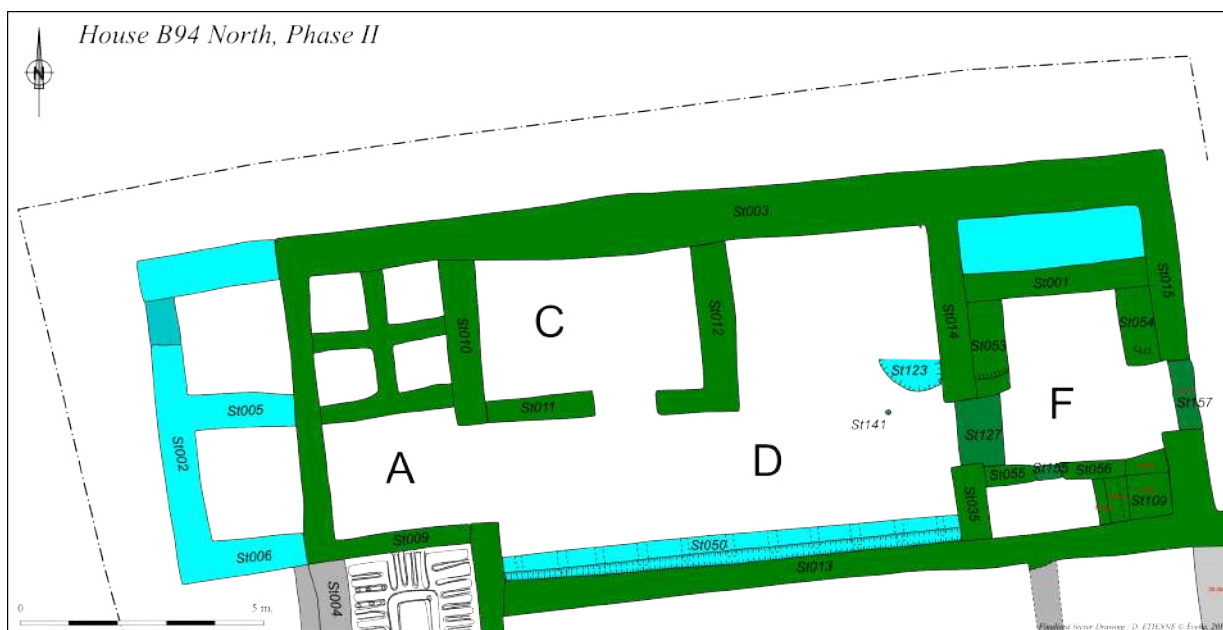

Fig.21_plan of the Northern House during phase II

is a small opening that provides access to a small closet located under the staircase. In both sides of the opening, inside the room F, there are two post-hole (ST128, ST129), probably the traces of a door or closure system of the space under the staircase. During this phase, there is a layer of ashes (UF2654) on the floor.

- Courtyard D :

During this phase, a structure (ST050) is built over a thin layer of earth (UF2607) along the southern wall of the courtyard (fig.22). It is a masonry 0,80 m high and 0,44 wide, which is running all along the wall of the courtyard, on 9,35 m of length. On top of it is a kind of small channel and on the facade are ten rectangular openings leading to small chambers, regularly spaced. The channel and the chambers do not seem connected and the function of ST050 remains unclear. During this phase there are a lot of fish bones and scales (UF 2570) in the northern part of the courtyard and the structure could therefore be linked to some kind of activity related to fish.

- Room A :

During this phase a small bench was built against the west wall, partly covering the basins, which were destroyed, and the whole room was backfilled and leveled with a new floor, accessible by a small ramp in the threshold.



*Fig.22_structure ST
050 along the
southern wall of the
courtyard B94D*

- Room J :

During phase II, two contiguous small rooms were built against the



*Fig.23_view of rooms
J and K from the
north-western corner*

western façade of the house (fig.23) . To the north, room J is a small square room, about 2.10 x 2.10 m, which is only opening onto the street by a door 1m wide in its western wall. The threshold was then probably at street level, later raised during Phase III as shown by a line in the masonry. The interior of the room is entirely covered with a

strong gray coating on the floor and walls (fig.24). The floor is covered directly by three levels of collapse and no occupation level was found which could provide information on the function of this room, possibly a small shop.



*Fig.24_general view of
room B94J*

- Room K :

The room K is in the south of the room J, and has roughly the same dimensions, 2 x 2,20 m. The walls are made in a quite irregular masonry and are not linked with the west wall of B94 but are with those of the room J. So these two rooms seem to have been built during the same phase. The floor is built on a heterogeneous backfill that contains potteries dated to the early 15th century. This floor is a poorly preserved clay surface, it forms a bench along the west wall of B94. No door was found for this room, whose walls are preserved up to 1.10 m. It could therefore be a storage room, with an access further up.

PHASE III (fig.25)

- Room D :

In phase III, a rectangular masonry (ST140), 1,50 m long, 0,82 m wide and 0,22 m high, was built in the northeastern part of the courtyard. It was erected inside a depression of the bedrock which it nearly completely filled. Its function is unknown, maybe a foundation or a base to support a structure related to a specific activity in this part of the courtyard which was weakened by the presence of the depression in the bedrock. A new floor (UF1965, UF1982) is built at that time and the associated material is dated to around the 16th century according to the study of the pottery.

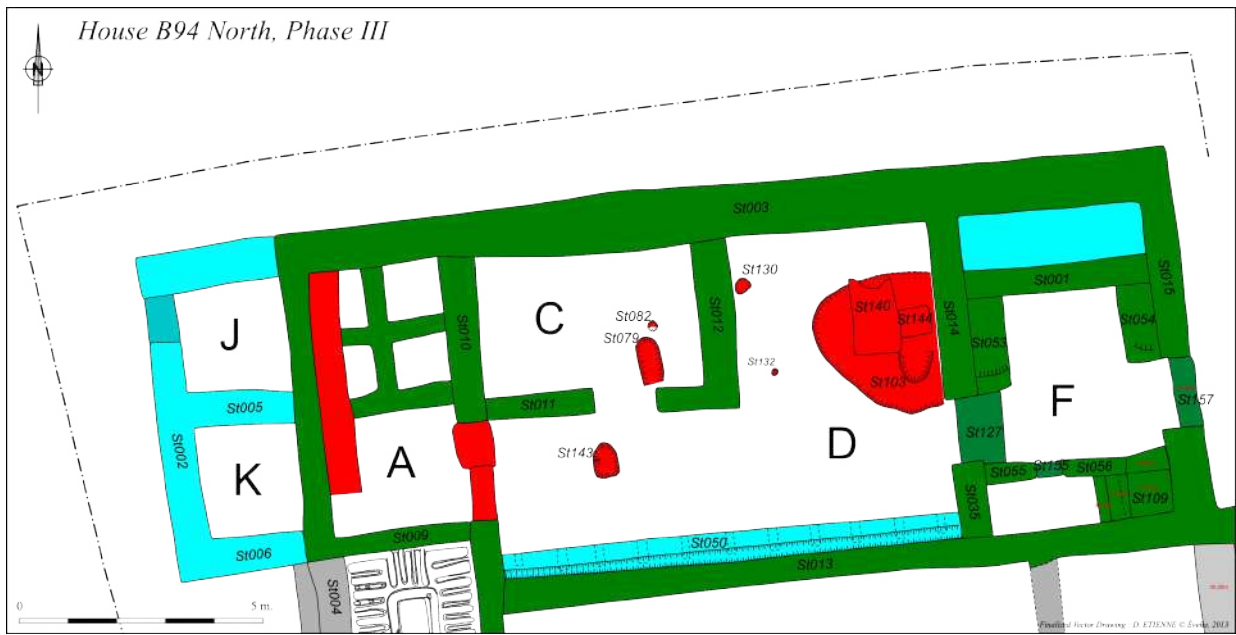

Fig.25_plan of the northern house during phase III

PHASE III bis

- Room D :

In phase IIIbis, a lot of fish was burnt in a pit (ST100) located just over the structure ST140 of phase III. As a matter of fact, phases IIIbis and III are probably of the same period. The wall ST098 was levelled during this phase.

PHASE IV (fig.26)



Fig.26_plan of the Northern House during phase IV

- Room D :

In this phase, a circular stonework as a billot (ST083) with rivulet (ST122) was built on the levelled top of wall ST098 (fig.27). Beside,



*Fig.27_the courtyard
B94D in phases II-V*

on the ancient floor (UF1982), there is the mortar layer of construction (UF2569) of the structure ST083. On the new associated floor (UF1724), were found three complete potteries, dated to the 16th century (fig.28), and one stone anchor (fig.29). Two hearths (ST77, ST104) are also in relation with this floor.

- Room C :

During this phase a new floor is built in room C (UF1768). Firstly in the phase, a post-hole (ST092) was dug. After, there is a little thermic degradation (ST082) in relation with a hearth (ST079). Finally in this phase, three pits were dug in the second floor in the eastern part of the room. In pit ST069, a big black jar was put down (fig.30). Between the pit and the jar there is an organic layer, which is probably an organic propping. The two others pits (ST80, ST81) did not contain jars anymore but only jars fragments. One of these jars was probably blocked in the pit with mortar. During this phase the threshold of the

Fig.28_Pitcher found on the floor UF1724 of the courtyard, phase IV

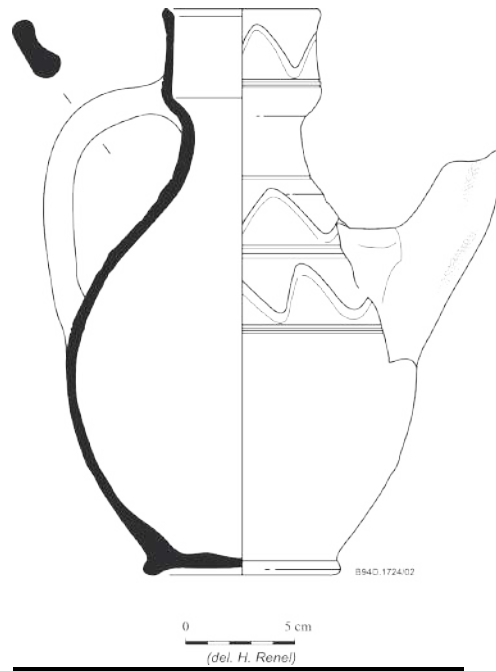

Fig.29_Stone anchor found in the courtyard B94D, phase IV



Fig.30_Large jar in situ in room B94C



room was raised. This phase is dated between the 15th and the 16th centuries by the ceramic.

PHASE V

- Room F :

The phase V is a reoccupation of the room showing the presence of many animals. All the thresholds are raised (fig. ???) (ST156, ST154, ST57) and the closet under the staircase is covered with an organic layer which could be linked with the presence of poultry (UF2655, UF2656, UF1902).

The cistern was at that time filled with a backfill with many stones (UF1711), which delivered ceramics of the 16th century (fig.37). It was then sealed with a strong plaster coating thus transformed into a platform.

- Room D :

The last phase of occupation is the same as in room F, a re-occupation for animal husbandry. There is an organic layer (UF1969) in the northern part of the courtyard which seems to indicate the presence of animals. The associated ceramics are dated to the 16th century.

- Room C :

The phase corresponds to the level of abandonment and collapse of the room (UF1754).

- Room A :

The first level of collapse is characterised by the presence of numerous fragments of an organic vegetal or animal material, as a felt tissue, which most probably comes from the ceiling or the upper floor. The upper levels are collapsing with some traces of squatter re-occupation.

- Room J :

Only a few vestiges of occupation have been discovered in the collapse levels, they probably come from the occupation of the second floor.

- Room K :

Several levels of collapse have been identified. The oldest has delivered a large amount of organic material identical to the one found in room A and probably coming from the roof of the room, or from the first floor of room A as it is probable that room K had no upper floor.

1.2. The Southern House

The southern house is bordered to the west and south by a street leading to the area of the ceramic workshop B41.

It includes eight rooms, or separate spaces (B, R, L, G, H, Q, M and P), and a courtyard (I). It is accessible through a gate in the southern facade leading to an entrance room.

PHASE I (fig.31)

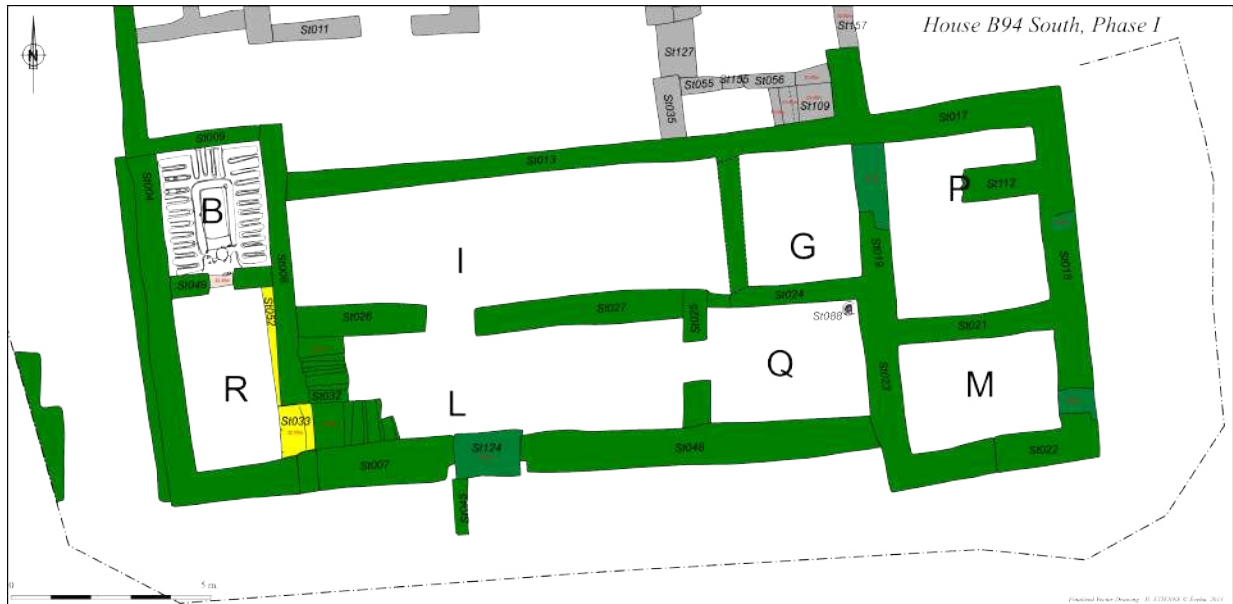

Fig.31_General plan of the southern house in phase I

- Threshold south :

The original doorway (ST126), 1.20m wide, is bound on a packed earth just above the bedrock (UF2572). The threshold consists of small stones in a packed earth mortar, and can be associated with the construction of a long wall seat to the west, along the wall ST007. The face of this wall seat was coated with waterproof mortar, later demolished in the second phase.

- Exterior South :

The first construction is made of a course of square stones standing on a filling of packed earth levelling the bedrock (UF1978). Above it there is an occupation layer consisting of packed earth with chalk and charcoal (UF1971).

- Room L :

The gate of the southern house was leading into an elongated entrance room ??? x ???m, i.e. ???m². Against the left side (west) of the room was located a staircase leading to the first floor, with an intermediary platform giving access to the door of room R/B (see infra) (fig.32). The walls, floor and stairs were all covered with a strong plaster. To the right (east) hand side, a door was leading to room Q (infra). And opposite the entrance was another passage leading north into the



Fig.32_The staircase in the entrance room B94L of the southern house, with the door to room B94R

courtyard of the house, room I.Courtyard I :

All those constructions have been cleaned, backfilled and covered by a floor (UF 1736, UF 1819). This leads to the second main occupation of the courtyard.

- Room B/R :

Room B/R is located to the left hand side of the entrance room, at the western extremity of the southern house. It is accessible through a door 0.60m wide located on the intermediary turning step of the staircase leading to the first floor, 60 cm higher than the level of the floor of the entrance room and the room R/B (fig.33) .

This room is divided into two spaces by a low partition wall (ST049) 55 cm thick and 90 cm high, with an access in the centre (UF1710).

The rear part of the room (B,8 m²) includes a madbasa (fig.34), a typical traditional Omani domestic structure for the production of date honey (dibs). Many examples of madbasas are still standing in the old dwellings structures or forts in Oman, used to make date juice or honey, called dibs. They are made of network of parallel small canalisations separated by low ditches and converging down to a final container. Dates of a special specie are piled up on top of the ditches, most often in tissue bags or palm baskets, and under the action of heat they exude the juice which flows down to a basin or a buried jar. The

Fig.33_ East wall of room B94R based on top of a wall of the early building



Fig.34_ The madbasa in room B94B



madbasa in B94 is constructed with mortar armed with little stones (coral), the ditches and canalisation covered with mortar. The network of drains has a slight slope from north to south, and conducts the dibs juice to a buried jar situated at the end of the slope, just in front of the access in the low partition wall. A little platform was located in the centre of the structure, permitting an access to put the date bags on the rear part of the madbasa.

The madbasa seems to have been built directly on the bedrock and no former layer could be identified underneath. It is surrounded west, north and east by the original walls of the room (ST004; 008; 009), and south by the partition wall with space R, covering the entire surface of space B.

The front part (R) of room B/R, 9 m², was probably a storage area, et two complete grinding stones were found there (fig.35). The floor associated with the madbasa is also associated with the ancient walls which was reused to make the base of the eastern wall of the room, and is therefore the same as the one already in use in this area at the time of the earliest building, (UF1720, see supra). In the south a filling of dark and sandy earth containing fish bones and ceramics was put between



*Fig.35_Grinding stone
in room B94R*

the floor of room R (UF1745) and the later wall (ST07).

- Room Q :

Room Q measures 11m² and is located on the right hand side of the entrance room, to the east. The room construction began with the building of the northern wall (ST024), belonging to what was probably a tower of the house (infra, room G). Its foundation is made of packed earth with big stones. After this first construction phase, the bedrock

was levelled with a heterogeneous layer containing coral, fish bones and charcoal (UF1835), on top of which was built the wall (ST048), southern wall of the house, which is contemporaneous with the construction of the earliest floor of the room. The material of this

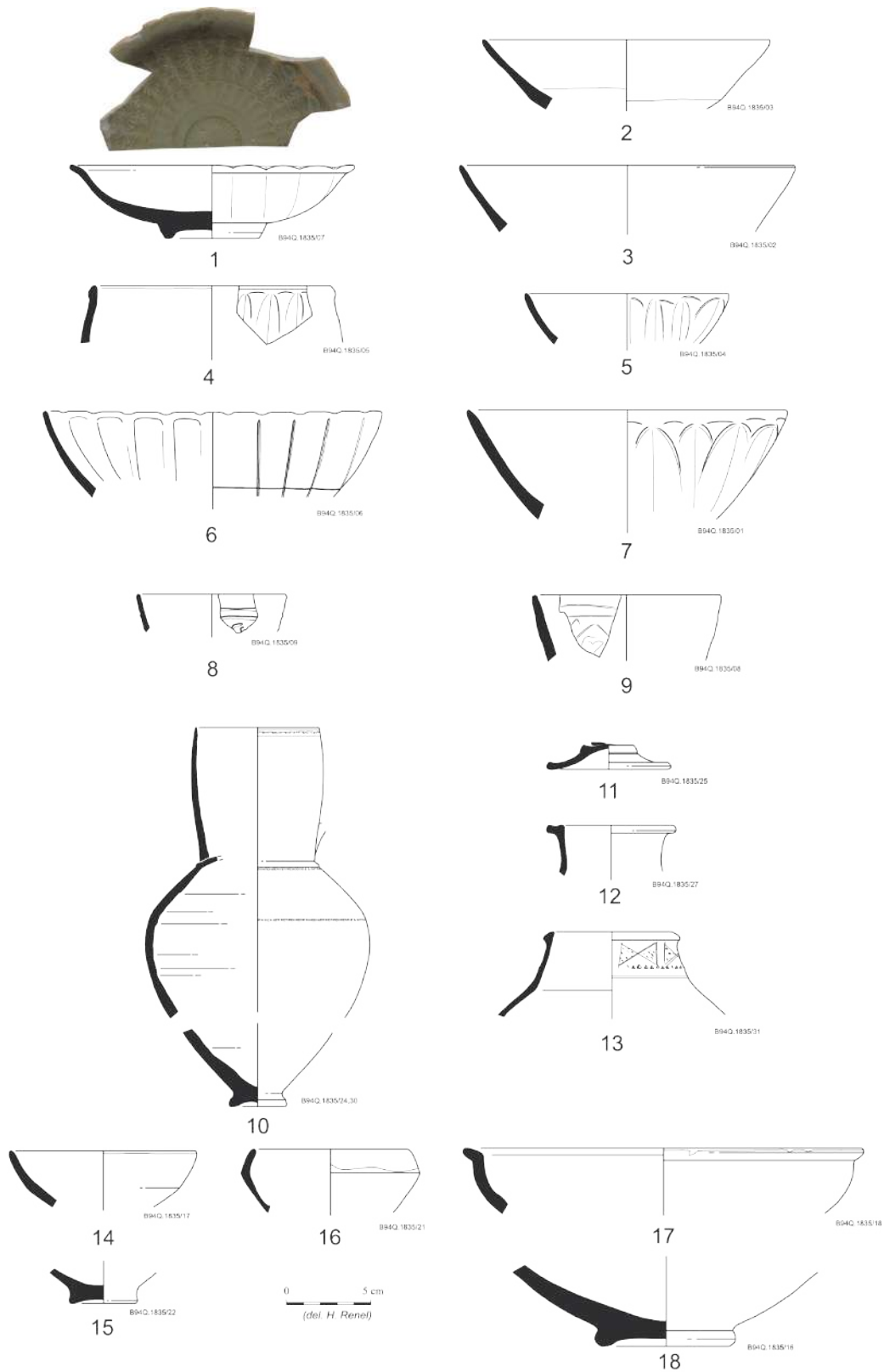

Fig.36_ Ceramics from the construction backfill of room B94Q (UF1835), 14th century

backfill construction level of the house is rather abundant and varied, with many imports and local productions, and can be dated to the first half of the 14th century (fig.36)

The first occupation layer in room Q is a thin grey earthen floor (UF1805), which lies on a thin filling (UF1831). We can notice a small post hole (ST088) on the corner of the eastern wall (ST023).

- Room M :

The phase 1 corresponds to the construction of the room M with four



Fig.37_Excavations in room B94M

walls (ST018, 021, 022 and 023) (fig.43), a layer of occupation (UF1455 and 1451) and three layers of demolition (UF1443, 1471 and 1434) (fig.37).

- Room G :

Room G, 9 m², is located east of the courtyard. The lower level is a compact backfill (UF1795) made of earth and gravel levelling the bedrock, whose associated material is dated to the 14th century (fig.38). Over it was built the eastern wall (ST019) and also probably the southern and northern walls (ST024 and ST013), although safety reasons in excavations prevent visual observations in those two cases. Over this first backfill, a second one (UF1786), made of brown orange compact earth mixed with small stones, was laid, leaning against the foundation of the wall ST019, probably also against ST024 and ST013, and on top of which was built the west wall ST036. Over this second backfill was built the original floor of the room (UF1780), made of limestone powder and strongly compact in surface. It is associated with remains of an occupation level (UF1893 and UF1894).

Fig.38_Ceramics from the construction level of room B94G, first half of the 14th century



- Room P :

After the early occupation of the area about which very few can be said (supra), the first evidence are the external walls themselves and probably the inside partition wall ST112, which precise use is still unknown. Several levels of backfill also probably date from this first occupation.

After the peripheral walls of the room were built, a first backfill was laid leaning against the walls, with brown soft earth mixed with many gravels in the northern part of the room (UF1932), and brown soft earth mixed with gravels and medium-sized stones in the southern part (UF1923). On this backfill was erected the partition wall ST112. South of the wall ST113, three successive layers of backfill were then deposited : the level UF1930, made of brown compact earth mixed with some charcoals and very few small stones, the level UF1929, made of brown and black soft earth, and the level UF1927, made of brown compact earth,. All those five levels are probably part of the same phase, to create a horizontal surface for occupation of the room. In that case, the really badly preserved level UF1926, made of really compact earth with traces of plaster can be identified as the floor of the room in phase I.

- Exterior West :

In the street west of B94, the first level associated with the house (UF1951), up the level dated to the early building (supra), is a compact earth level. It is associated with a structure ST085 discovered at the edge of the sounding outside B94 and with the west wall (ST004) of B94.

- Exterior East :

The second floor discovered east of B94 (UF2550), made of strong yellow and white mortar, is partly covering the previous floor (supra) but not entirely. Some irregularities of the bedrock were also not covered by it. It is yet difficult to link this ground level to a precise phase of occupation, either to the earliest building or to the first phase of construction and occupation of the house B94.

PHASE II (fig.39)

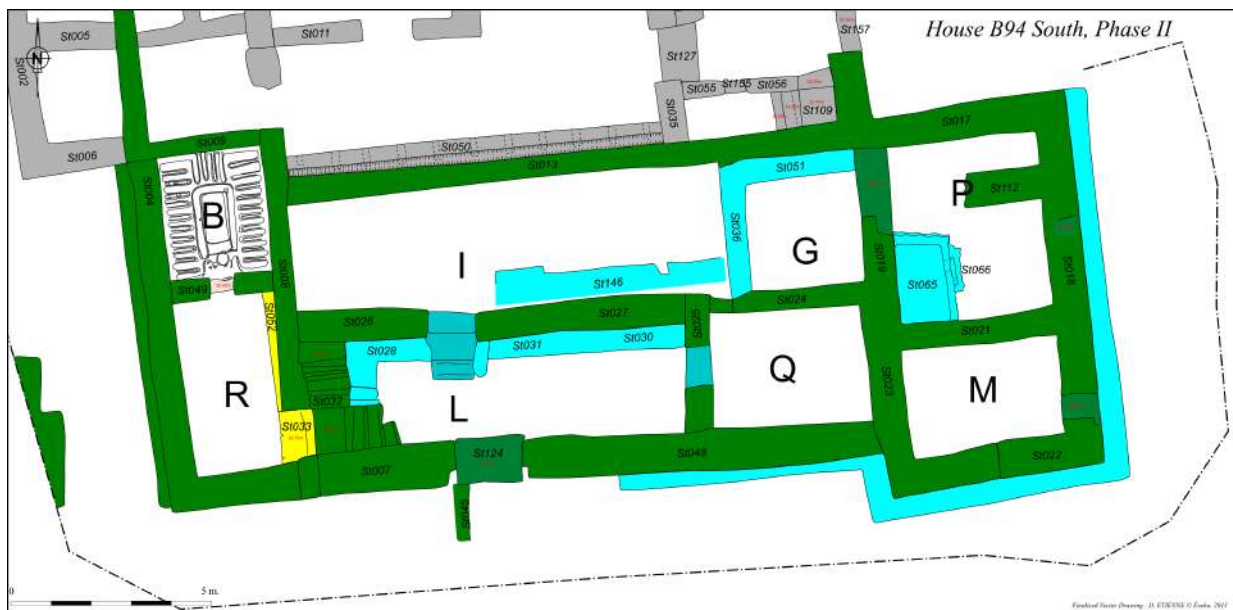

Fig.39_General plan of the southern house in phase II

- Threshold South :

The floor of the first phase was raised with a backfill of packed earth (UF1981) to make a second floor (UF1980). It runs with a threshold made of a row of large stones, which shows a hole maybe to insert a pivot.

- Room L :

During phase II benches with armchairs were built against the north and west walls of the entrance room. The whole room, including benches and staircase, was covered with a strong sarouj mortar, giving to the guests an inviting space (fig.40) .

- Room Q :

A second floor testifies to the second phase of activity in this part of the house (UF1791). It consists of an earth beaten floor just on the top



*Fig.40_General view
of the entrance room
B94L with benches*

of the occupation layer of the previous phase. It may be running with a small firing place in the south side of the room (ST090). Small finds related to this phase (UF1771).

- Room G :

At a time that cannot be precised yet, the western wall of room G against the courtyard collapsed, or was destroyed, and it was rebuilt together with a reinforcement wall (ST051) thickening the existing northern wall ST013, to provide more stability to the rebuilding. In this rebuilding phase, the wall ST051 was built over the floor and occupation level of phase I, while the new wall ST036 was built by pushing the foundation blocks of the previous west wall inside these two levels, the main parts of them having probably split into the courtyard. After this rebuilding, a new level (UF1772), made of brown compact earth with few small stones, was laid. Over this level, close to the new wall ST036, a thin layer of charcoals and ashes indicates the presence of a small hearth. Both levels are covered by a thick soft level (UF1764), made of brown and black earth with many charcoals and artefacts, either an occupation layer or a backfill with reject of waste.

Above this level was laid a new backfill, 1m thick, made of four layers. The two lowest ones (UF1763 and UF1764) are made of brown soft earth mixed with different proportions of gravels, the third (UF1761) is made of medium-sized stones without earth, and the last

one (UF1760) is made of brown compact earth, mixed with gravels, a few small stones and some charcoals. Above this last level, a thin layer (UF1759) of compact beige earth, partially observable, may indicate the presence of a new floor, very badly preserved, raising the ground level around 1m higher than the previous floor. Above this presumed floor, a relatively thick level (UF1713), made of soft brown and black earth mixed with very few small stones, possible very small chips of

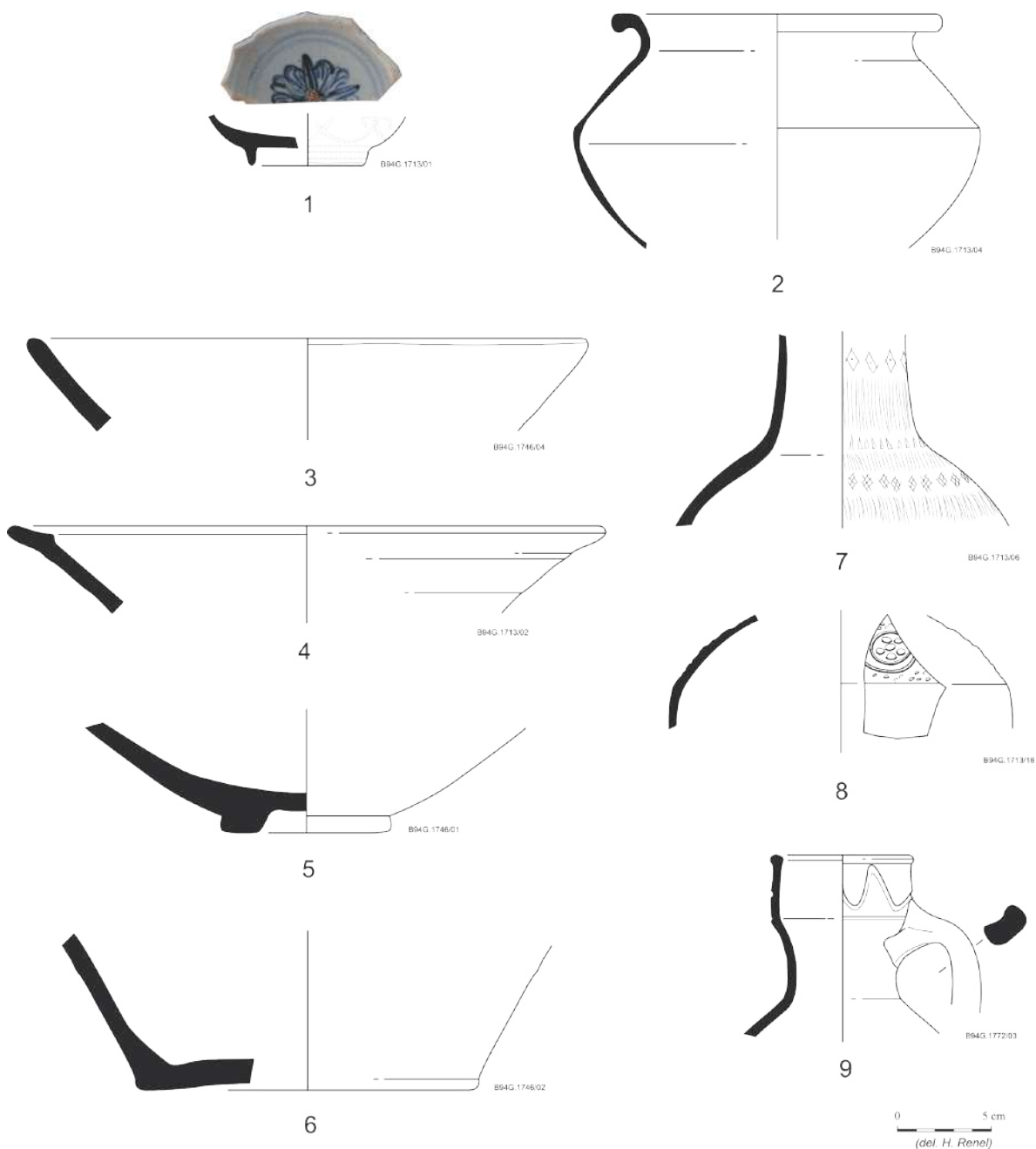

Fig.41_Ceramics from the last occupation of room B94G (UF1713, 1746), 16th century

plaster and many charcoal and artifacts, could be the occupation level associated to the aforementioned hypothetical floor. In that case, this level must be considered as the last phase of permanent human occupation of the room. It is dated by the ceramic study to the 16th century (fig.41).

- Room P :

This phase shows an important raising of the level by successive deposits of backfill, most of them having been thrown from the top of the wall ST112. South of the wall ST112, the lowest deposit (UF1907) is made of brown soft earth mixed with some medium-sized stones. Above it the level UF1922 is also made of brown soft earth but mixed with more stones of a larger size. Above it stands the level UF1921, made again of brown soft earth mixed with less stones of a smaller size. The fourth backfill level (UF1898) is made of gravels and small-sized stones almost without earth, and the course of excavation shows that it is the same level as one (UF1899) north of the wall ST112, where its height is lower and shows more earth.

All those levels were covered by an irregular but thick level (UF1879) made of brown soft earth mixed few medium-sized stones, leaning on the peripheral walls but covering entirely the partition wall ST112. Above this level was finally put down the backfill UF1834, made of brown and beige soft earth mixed with many stones of all sizes.

A tank (ST065), 3 x 1.5 m and 1 m deep, was built inside this level, probably also down inside the level UF1879 (fig. 42). A waterproof



Fig.42_The tank in room B94P, phase II

coating conduit (ST066), running along and through the eastern wall, can be interpreted as a water-conduit bringing water from above, which suggests that the tank was possibly a cistern although no coating is visible on its walls. It could be that such a waterproof coating was originally present and later collapsed, but no trace of it was found on the bottom of the tank. This one was covered by a level (UF1741), made of brown and black compact earth without stone and the same kind of deposit (UF1742) was found inside the conduct ; both could be interpreted as the final stage of use of the structure or the first stage of abandonment.

- Exterior East :

Some time after the construction of the house, a strong buttress (ST160), about 50cm wide and 1,20m high, was built against the whole of the eastern (ST018) and southern (ST022, ST048) walls of the house (fig.43) , probably to give more stability to the tower. The coating of this buttering is linked with an outside level (UF1884),



*Fig.43_The buttress around
the south-east corner of the
house*

PHASE III (fig.44)

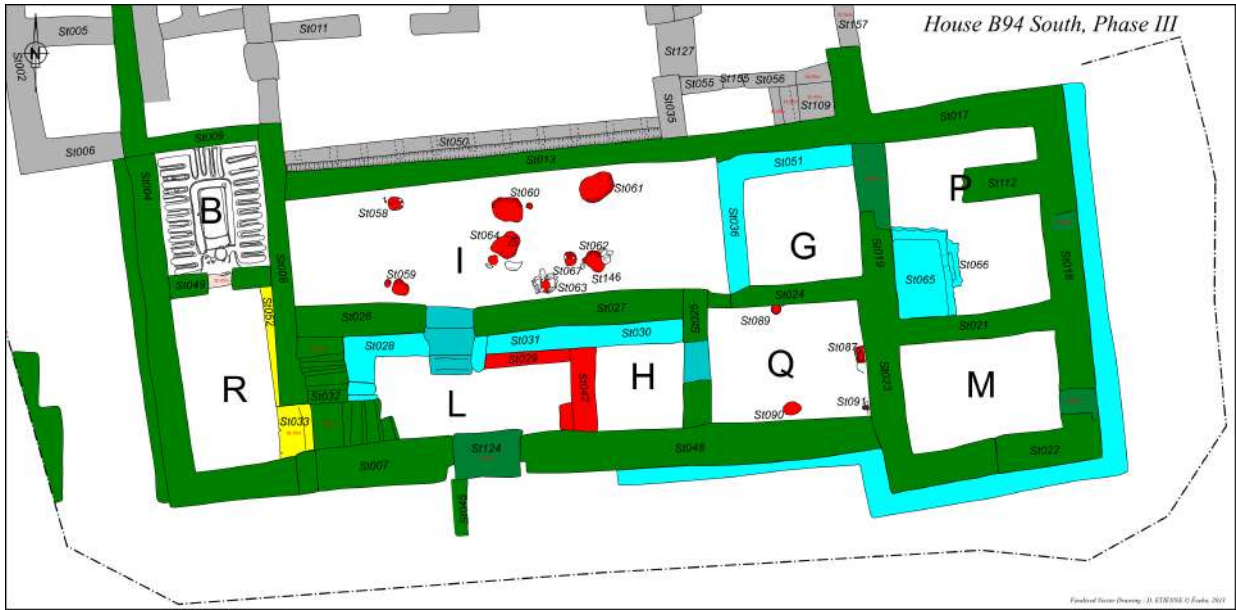

Fig.44_General plan of the southern house in phase III

made of strong compacted green earth, which obviously works with a second level (UF2552), made of compacted brown earth mixed with few small stones. Both levels create a flat and roughly homogeneous surface, covering the bedrock's upraising and cavities, and can probably be identified as a third street level in this area, consecutive to the construction of the buttress ST160. Room H :

During this phase, the rear eastern part of the entrance room L, was slightly raised as a platform, separated from the entrance itself by a low terracing wall and accessible by two steps. From this space H, a door was leading to room Q.

- Room Q :



Fig.45_The postholes in room B94Q, phase III

For post holes (ST087- 088 - 091- 089) were constructed at that time against the middle of the north, east and south walls of the room (fig.45) . The associated level is a layer (UF1767) of a powdery earth similar to decomposed wood, and it is therefore possible that the posts were supporting a wooden raised floor, or some kind of wooden

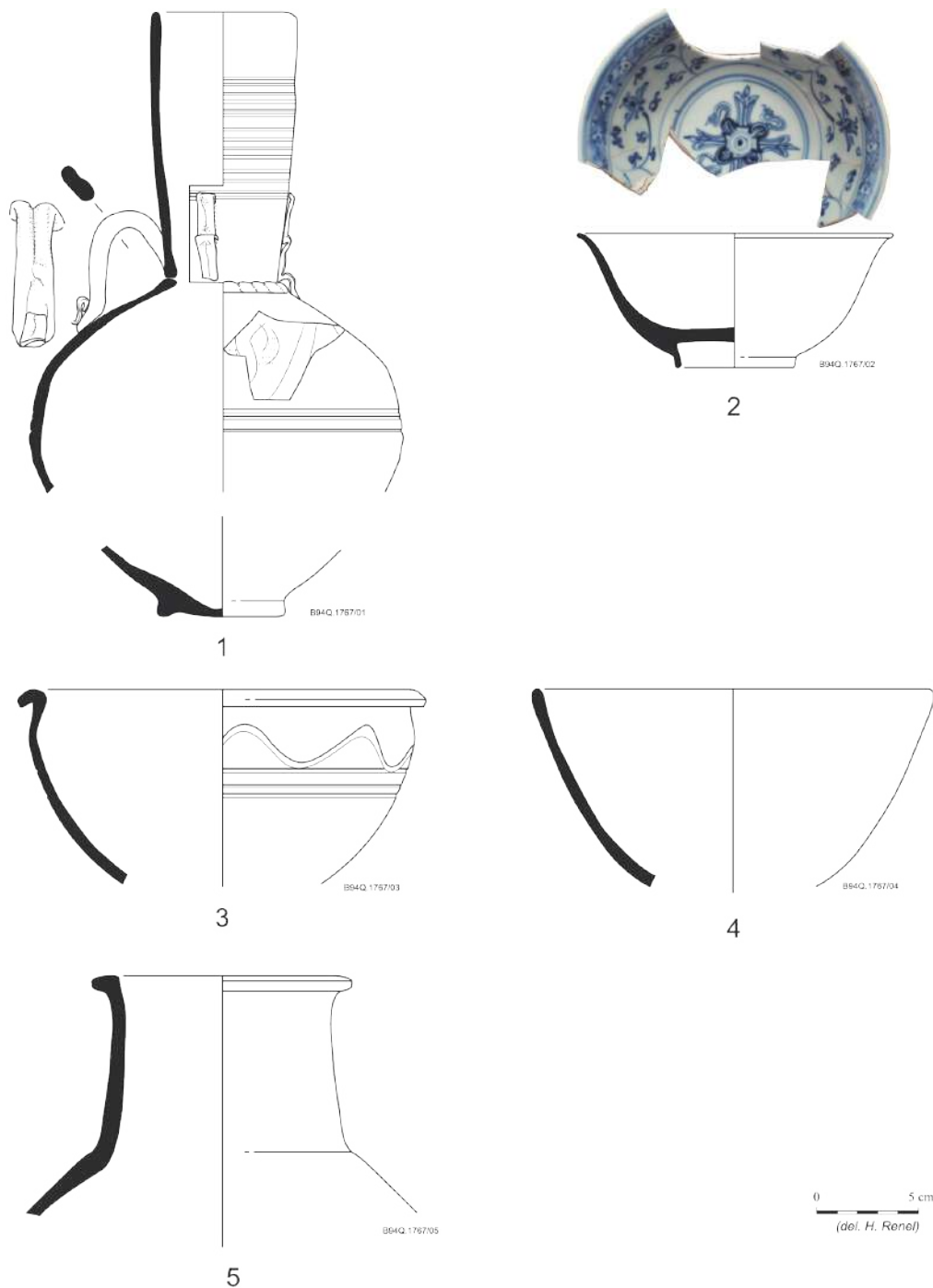

Fig.46_Ceramics associated with the wooden floor or structure in room B94Q (UF1767), 16th century

Fig.47_Carnelian beads associated with the wooden floor or structure in room B94Q, phase III



structure of unknown function. The associated ceramics are dated to the 16th century (fig.46) and several carnelian beads were also found (fig.47). This hypothesis should explain the high threshold to access to the room Q and the packing of the space H. This phase corresponds to the final abandonment of the house and the beginning of the destruction.

- Courtyard I :

During this latest period, the courtyard I was used as a dumping-

Fig.48_Hearths in the floor of the courtyard B94I, phase III



ground. Covering the hearths, a rubbish layer (UF1671) has been identified (fig.61), just under the first level of collapse of the superstructures (UF1666). Courtyard I :

In the courtyard, the third phase correspond to the installation of new floors of compact earth and gravel (UF 1736 and UF 1819).

At least 6 hearths have been identified on that floor. Most of them worked in pairs, a small one often linked with a big hearth. Sometimes, it's only burned earth, not even ashes. The most likely assumption made is that the small one could be a waste from the bigger hearth, in order to put a small pot on it, for boiling water for example (fig.56).

Thus, on this phase, the courtyard I was used as an “extra-kitchen”.

PHASE IV

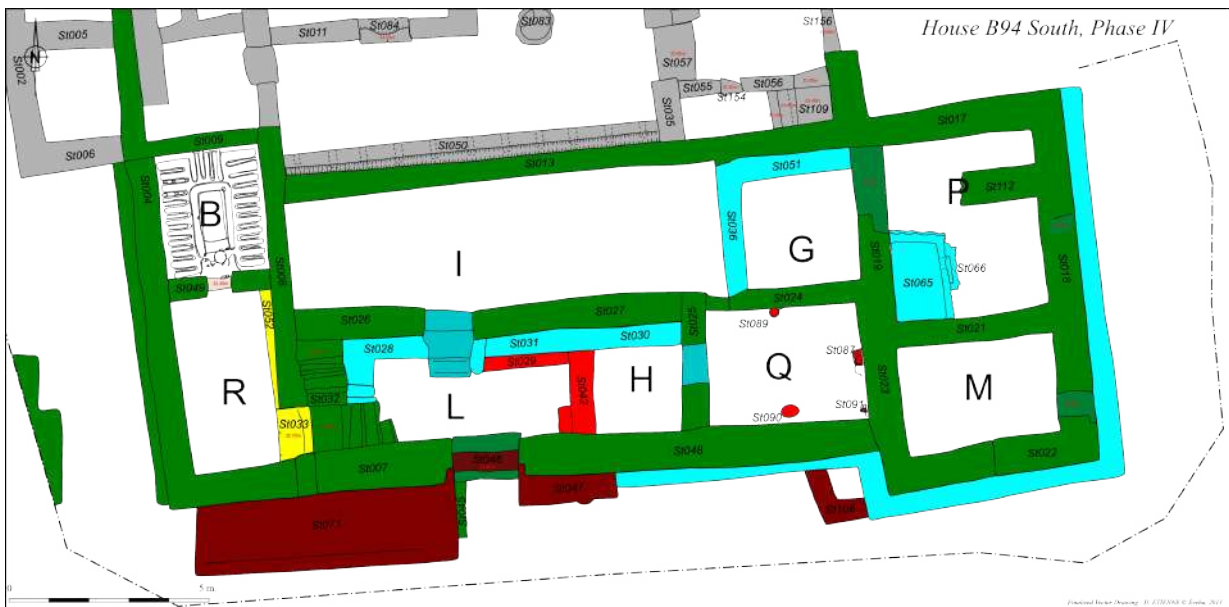

Fig.49_General plan of the southern house in phase IV

- Threshold south :

During this phase a layer of pebbles levelled the whole area (UF2582) and a new floor was constructed (UF1979). A hole was cut in the eastern wall to put a wood post maybe to maintain the step of coral stones in packed earth.

- Outside structures :

The structure (ST106) do not form a right angle anymore, an earthen mortar sticks the stones, which partly cover the former floor. A new circulation floor is created, just made of packed sandy earth (UF1967). Outside, the entrance to the house was fitted out, the residents have built a platform on the right hand side of the gate, 2x7 m (ST071), covered with gravel, and a coated bench on the left side (ST047)

- Courtyard I :

Henceforth the courtyard is not used as a kitchen anymore. During this phase the occupation level (UF1672) is a layer of compact earth without associated structures.

- Exterior West :

This phase (UF1774) corresponds to a refecton of the previous floor (UF1951) with a backfill installed between them which delivered pottery of the 16th century (fig. 58). It is the last floor associated with B94.

- External East :

The two former floors were covered by a thick level (UF1799), leaning against the buttress ST160, made of black soft earth mixed with many charcoals, artifacts and many fishbones and fishskins, suggesting that this level is a garbage layer but not necessarily from the house B94. According to the study of the pottery, the date of this layer is the 16th century (fig.59).
(fig.60)

PHASE V

This phase corresponds to the final abandonment of the house and the beginning of the destruction.

- Courtyard I

During this latest period, the courtyard I was used as a dumping-ground. Covering the hearths, a rubbish layer (UF1671) has been identified (fig.50), just under the first level of collapse of the superstructures (UF1666).

3. Synthesis on the evolution of building B94

Excavations at B94 highlighted an occupation spanning from the late 13th century until the second half of the 16th century.

The first building seems to have been in activity in the late 13th century and early 14th century. Several structures belonging to this period of occupation have been identified but none of them are specific, so it is very difficult to assign a function to this building. However, an evaluation of the shape and the area of the building is

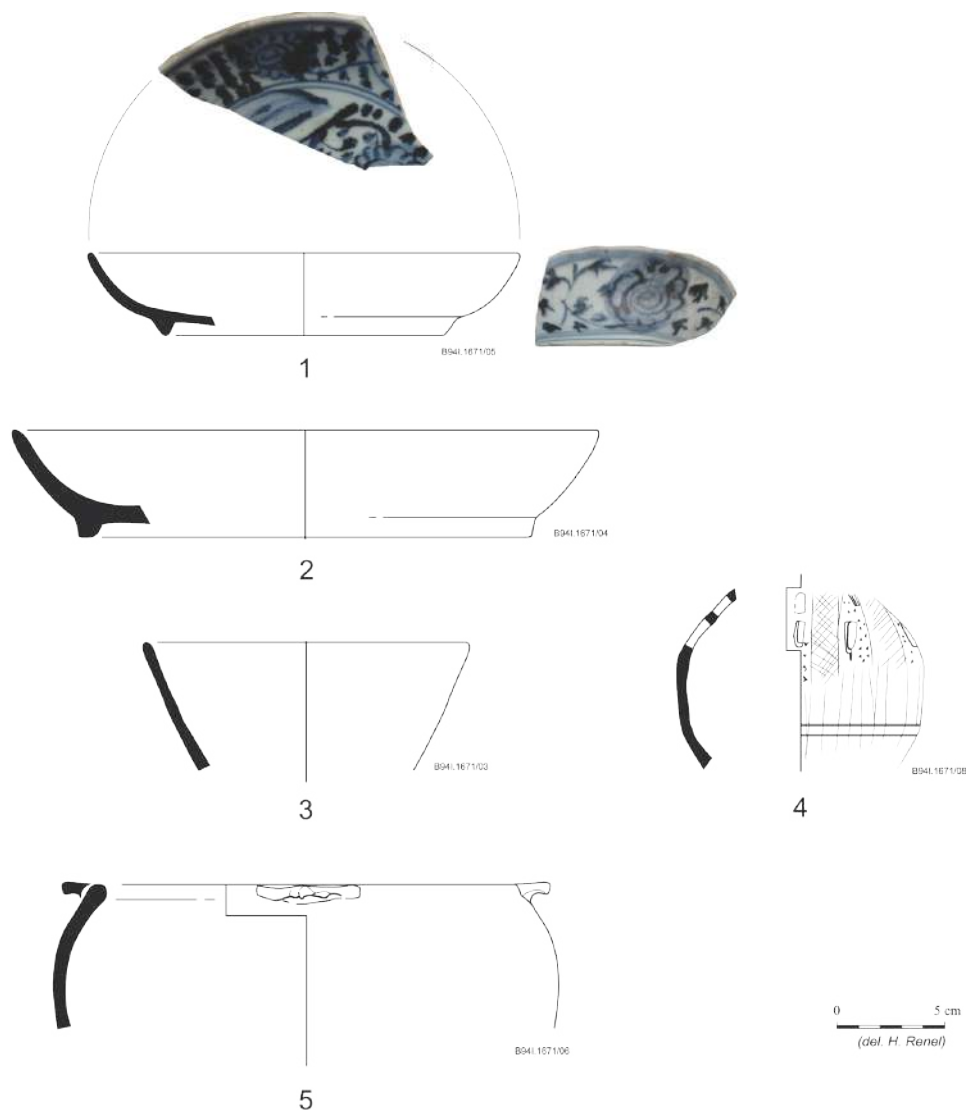

Fig.50_Ceramics from the last occupation (16th cent.) in B94I

possible (fig.51). Indeed walls ST052, 033, 098, 131, 134, 113, 110, 111 and 106 appear to define a rectangular space about 240m². Some parallel rows of postholes have been defined, but it is not really possible to determine their exact function.

The walls and the floors discovered east of the wall ST110/134/131 are probably also part of this first building.

Probably around the middle of the 14th century the earliest building was destroyed in order to construct a new building. The reason for this destruction is difficult to assess, but perhaps it is a change of ownership. The general orientation of the new building is similar to the previous one but its extension is more important, nearly 310 m². This building consists of two houses separated by a common wall between the two courtyards. The archaeological study has shown that these

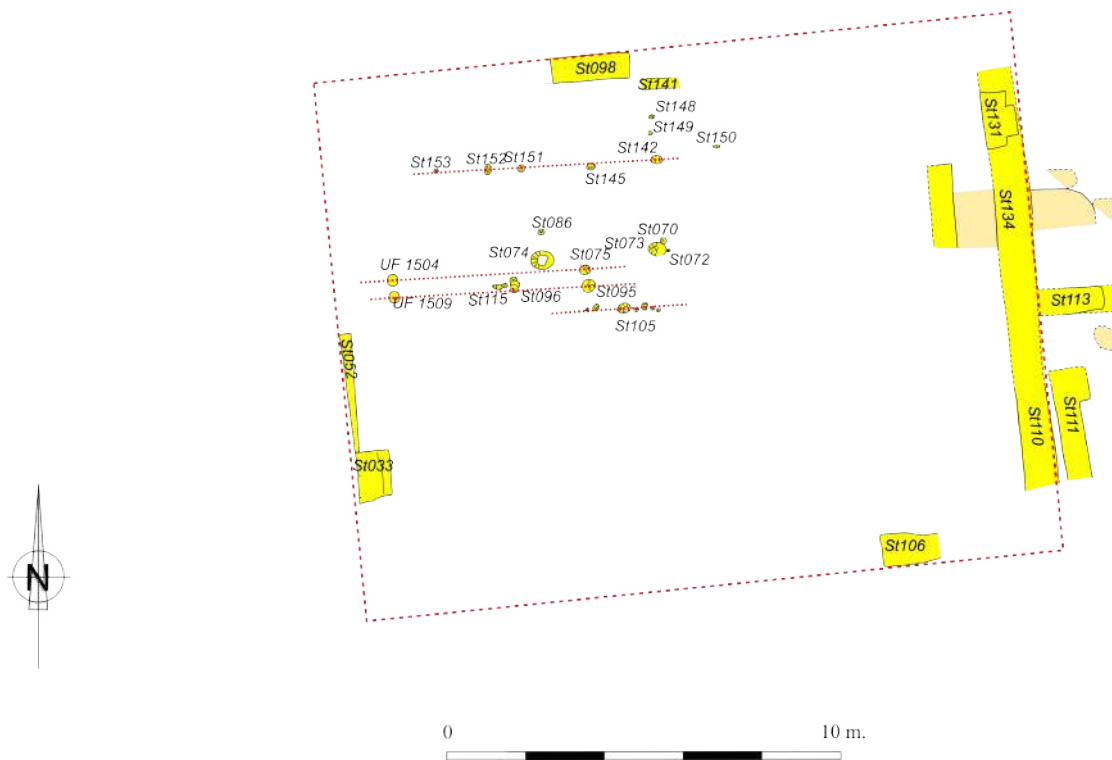

Fig.51_General plan of the vestiges of the early building under B94, second half of the 13th-first half of the 14th century

houses had been built at the same time. Both are organized in the same way in regard to the ground floor (fig.52).

First is an entrance room (F and L), with a staircase providing access to the first floor, and benches to accommodate guests. From this entrance it was possible to access in a straight line to an open courtyard (D and I). In each house, it is also possible to identify a room (A and B) for the artisanal production (the dibs for the southern house) and an associated nearby room (C and R) for storage of products. The southern house is larger than the northern one, so there are four more rooms. The room Q could be an office, the room M is interpreted, for the moment, as a pantry with an access from the first floor. During the first phase of occupation it is possible that there was a door between the courtyard I and room G; in this case the function of the room G could be a storage place. The presence of a door here should explain the fragility of the wall, its collapse and its reconstruction during the second phase, but this time without a door. The room P seems to be a massive tower, with a full basement at ground floor level: the excavation has shown that the volume corresponding to the ground floor was filled by backfills and only the first floor was accessible, from the room G. This room could be a tower for observation. Indeed, from the top there is a great view on the bay where the boats had to be moored.

There is little information about the first floor but there were probably

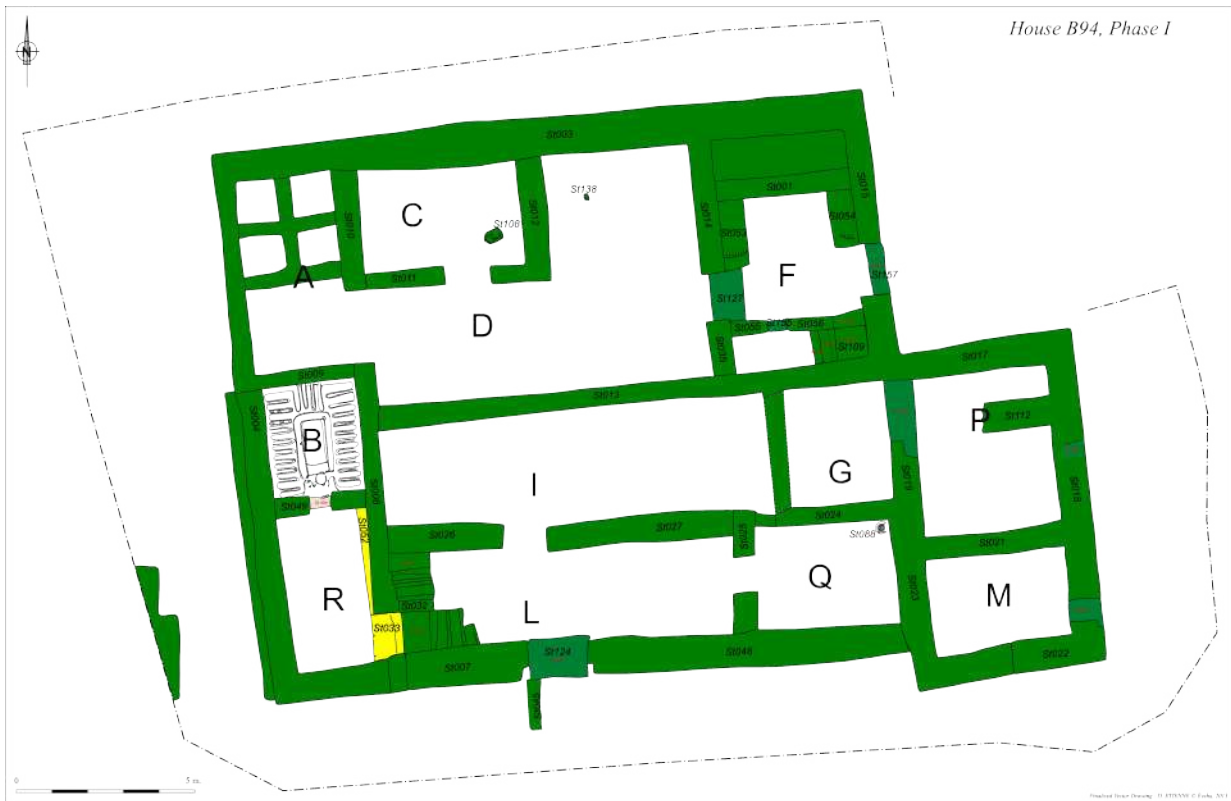

Fig.52_General plan of the house B94 in phase I

rooms organized around the courtyards. These rooms should be the housing area while the ground floor was rather a craft space.

Over the centuries, the building has undergone some changes, but it seems that the general organization remained the same.

The second phase of occupation, dated probably around the 15th to the 16th century, present in both houses, is mainly characterized by the construction of two outer rooms (J and K) to the west of the northern house. Also in the courtyard of this house a long structure (ST050) was built running (fig.53) along the common wall of the two houses. Its function remains uncertain but it is possible that this is related to fish processing and could have a link with the basins discovered in room A. The two new rooms (J and K) could be a little shop and a little store linked with the fish activity. The cistern of the entrance was refill to be transformed in a platform or large bench. In the same time there were some works in the southern house. The collapse of the wall between the room I en G. revealed the structural fragility of the house and some repairs were made, the wall was rebuilt without a door. A buttress was also installed outside, along the east and south walls of the house to strengthen the highest part of the house. Also for a better welcome some benches were built in the entrance room. The madbasa, the store, the office and the courtyard still kept the same activity.

The 16th century saw few transformations inside the two houses (fig.54). In the northern house a masonry was built in the courtyard D,



Fig.53_General plan of the house B94 in phase II



Fig.54_General plan of the house B94 in phase III

probably as a kind of worktop (ST140) in relation with the long structure (ST050) still in activity. The door between the courtyard and room A was narrowed and a bench built in room A. Some transformation in the southern house are also noteworthy. For some still unknown reason, a large platform (H) was constructed in the eastern part of the entrance room (L). It was limited by a low retaining wall and two steps enabled to access to the top of this platform and from there to the room Q and its new wooden floor set on five posts. The wooden floor is probably the layer UF1767 where a lot interesting artefacts were found. During the last occupation, dated to the second half of the 16th century, the inhabitants made many modifications in northern and southern houses (fig.55).

In the courtyard D, a billot and a rivulet replace the masonry (ST40), in relation with circular pits whose function is difficult to explain. Concerning the southern house the people installed facilities outside, may be a lot of people patronize this place.

The second half of the 16th century marks the abandonment of the building. However, it is worth noting that the northern house kept an animal-husbandry function. In room F all thresholds were raised and the closet under the staircase in the entrance room F has become probably a chicken coop. The northern part of the courtyard D became an enclosure .

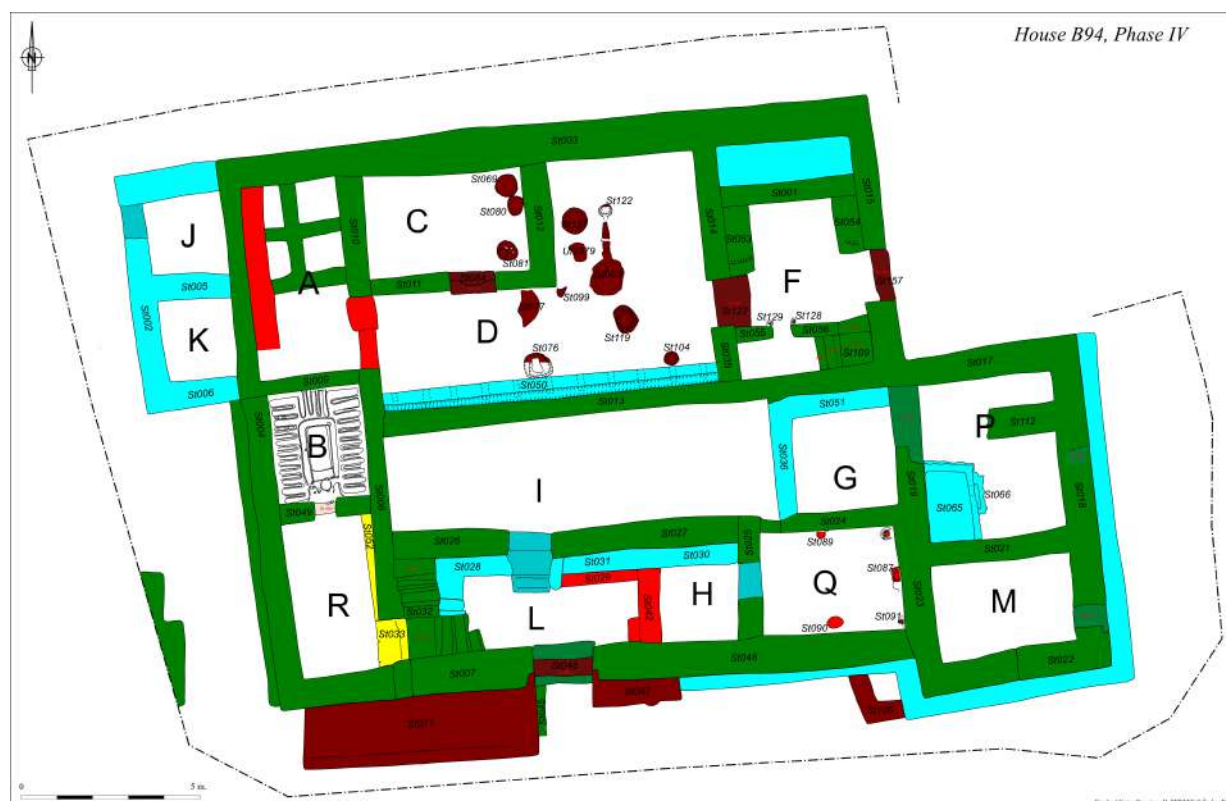

Fig.55_ General plan of the house B94 in phase IV

4. Conclusion

The earliest building identified in area B94 is dated to the late 13th century and early 14th century. It was nearly entirely destroyed when the later building was constructed and its plan and function are very difficult to define.

Five main phases of occupation were identified in the second building, ranging from the 14th century to the end of the 16th, the date of the final abandonment. All along these centuries, the building kept the same general organisation that is to say a ground floor assigned to the craft and selling, at least since the 15th century, and a second floor probably devoted to private space.

The observation of the masonries, including the connections between the walls, could give an indication of the relative chronology of the buildings. However, it was proved that the masonry techniques were not a sufficiently accurate indicator to assess the chronology.

Many coins were discovered during this season, which were often found “in situ” and could therefore give a more precise date to the successive phases of occupation. Although most seem undecipherable, it should be important to entrust these artefacts to a specialist in order to clean them and try to get information as to their provenance and dating.



Fig.56_Proposition of restitution of the first floor of B94

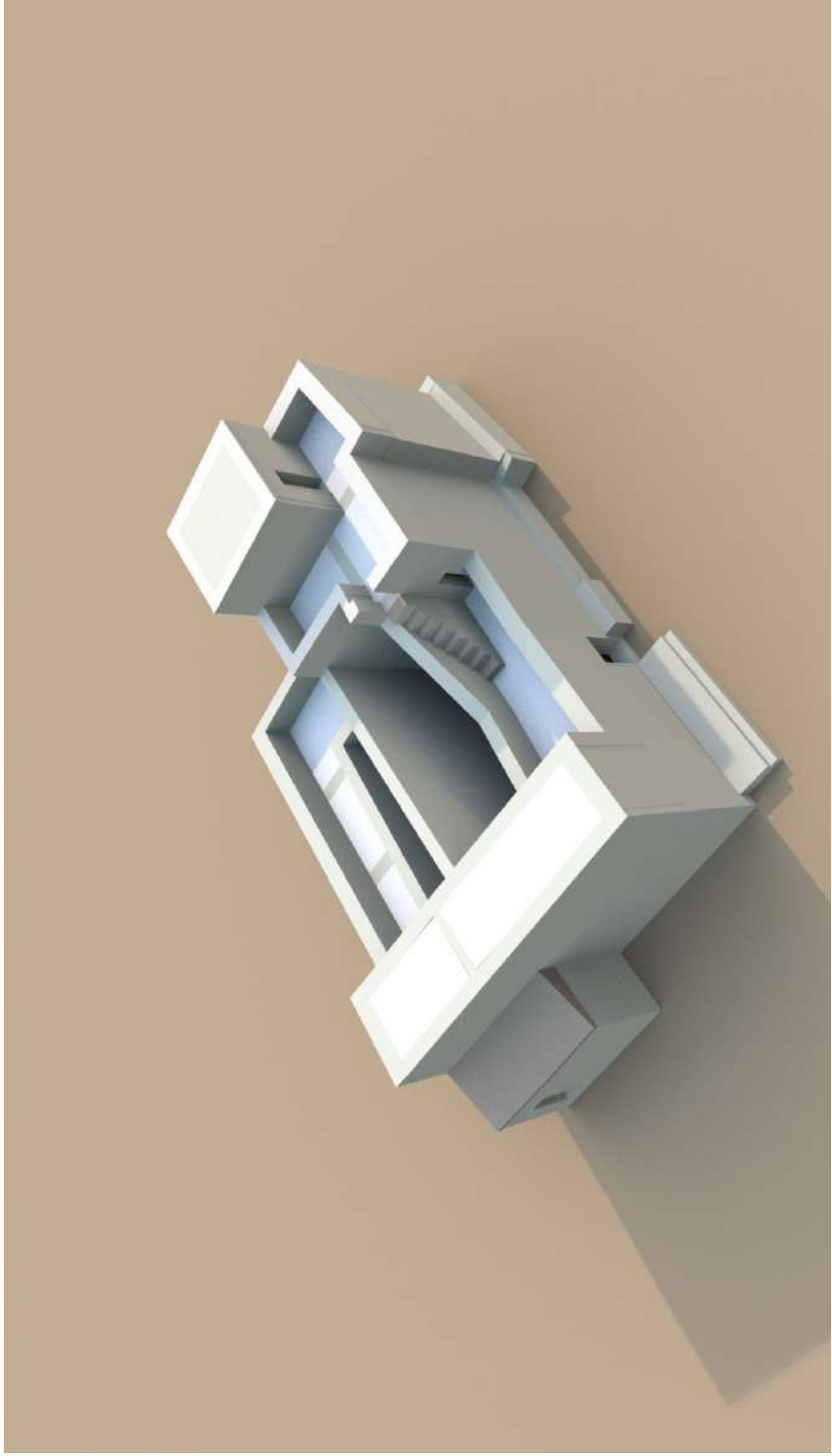

Fig.57 Proposition of restitution of B94

B 94, preliminary results of the ceramics analysis

Hélène Renel

B94 and B21 delivered a huge amount of ceramics, in the occupation layers as in the collapse levels, which was registered daily on the ceramic database all along the excavations period. Given the mass of material, only the ceramics from B94 could be studied during a two weeks mission in April, and the analyze of the shards from B21 had to be postponed until the next season. The date of the different occupation levels of B94 given by this study is integrated in

the architectural and excavation parts of the report (supra). The recording and dating show significant differences in the proportion of productions and also in the origins of the imported ceramics between the date of the construction of the house (last 13th cent, first half of the 14th cent.) and the last occupations (16th cent.), which appears clearly on graphs.

On the first graph (fig.58), showing the ceramics present in the 13th

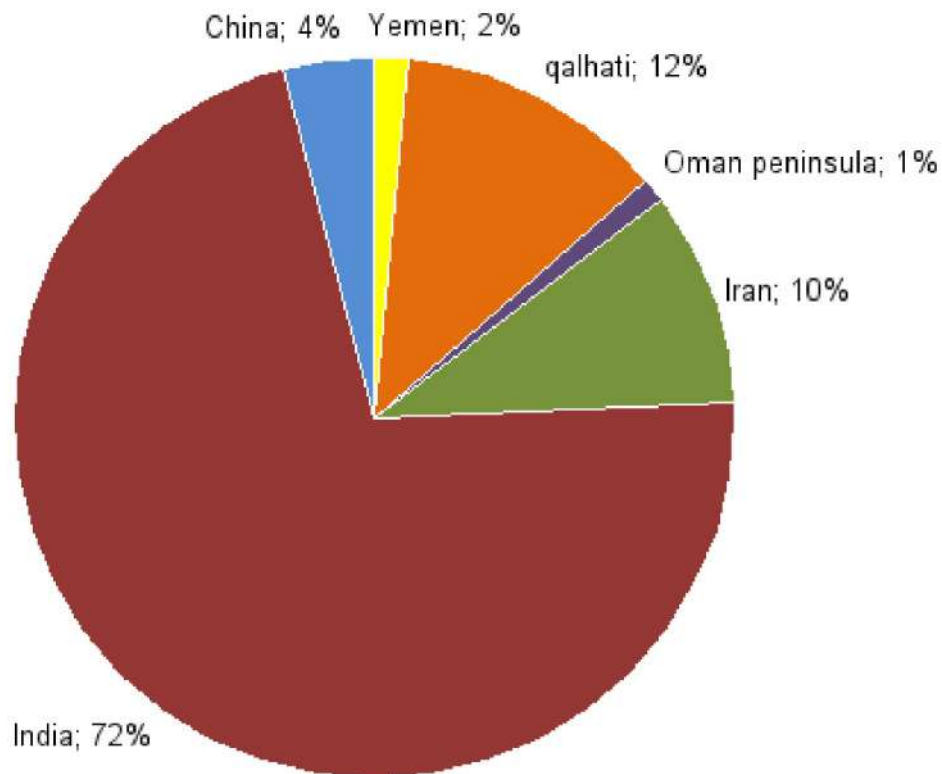

*Fig.58_Ceramic
origins in B94 in 13th
14t cent.*

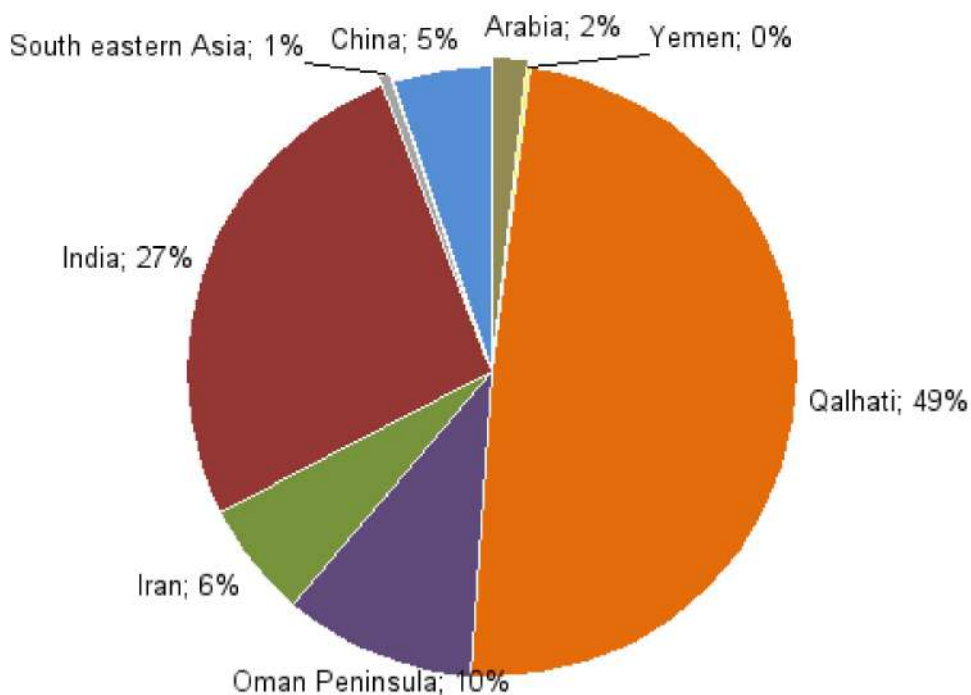

Fig.59_Ceramic origins in B94 in 15th 16t cent.

and 14th centuries levels, the imported ceramics form a large part of the material with the predominance of the Indian productions (72%). The imports come also from Iran (10%), China (4%) and Yemen (1%), while the local production are rather scarce, about 12%.

During the 15th and 16th centuries (fig.59), the amount of the imported material decreases compared to local wares and their origins change. The local and regional ceramics (from Qalhati kilns and the Oman peninsula) grow and form the majority of the material (59%). The trade with Asia continues in the same proportion but not only with China but also with Burma and Thailand.

Building B21 is located in the north-western quarter of the ancient city of Qalhât (fig.60), just north of building B94 (supra). It was already partly excavated during the first season of the Qalhât Project, in 2008, when the general plan was cleared and soundings opened in all the rooms and outside to have an evaluation of the stratigraphy and the history of the building. This year, the first season of the Qalhât Development Project had the objective to excavate and clear the building extensively, to complete the data about its plan, function and chronology and prepare it for conservation and display to the public.

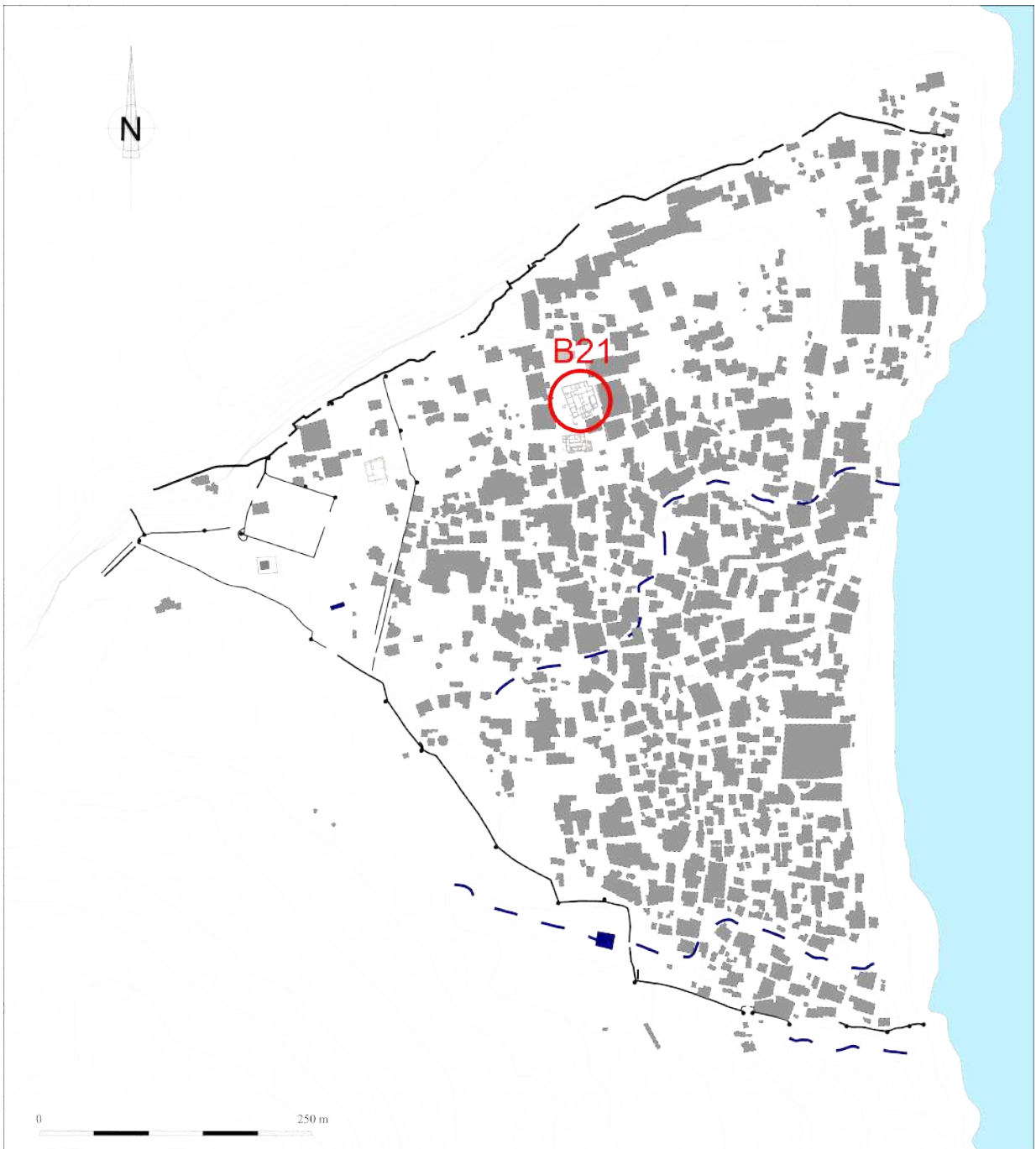

Fig.60_Location of B21

1. Earliest Building

This season completes the knowledge about B21 with the discovery of a previous building. The oldest constructions are visible only in rooms K and Z (Fig.61).

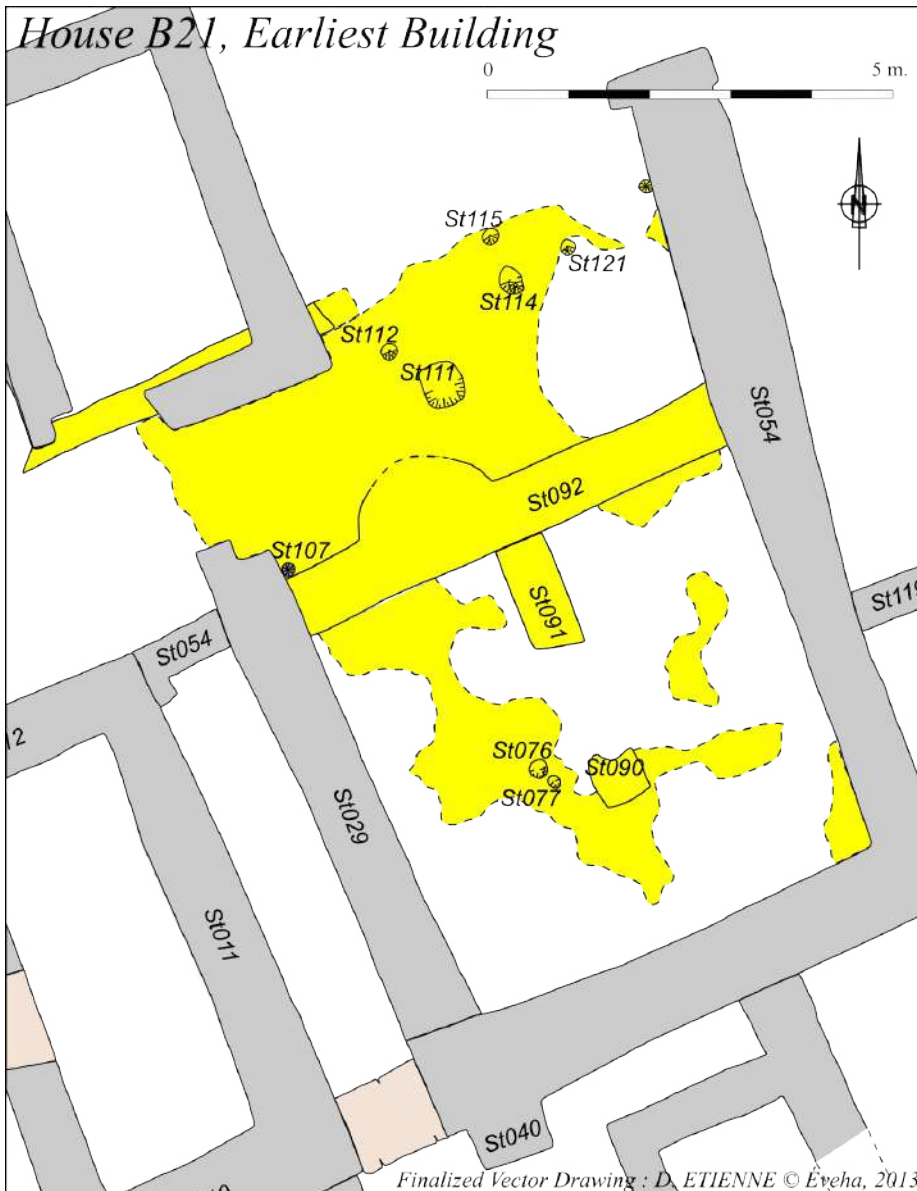

Fig.61_Plan of the vestiges of the early building under B21

The first trace of human activity in the area appears to be a massive supply of gravels (UF2180) quite without hearth, in order to create a flat level above the bedrock. Probably shortly after, a former building was constructed, of which remains two ground floors and three unequally preserved remains of walls.

The main and well-preserved structure is a east-west wall (ST092), 5,60m long and 70cm wide, made of stones binded with strong red mortar and external white coating on the northern side and dividing the internal space in two unequal parts. On the northern side, the wall present a semicircular protuberance (Fig.62). Perpendicular leaning

Fig.62_Semicircular protuberance on the wall ST 092



on this wall on its south side, was found second one (ST091), 60cm wide and 1,4m north-south long, made of stones binded with earth. The third wall (ST090) lies 1,50m south of this wall but well-aligned whit it, is badly preserved and consists of a roughly square remains 60cm wide. In the south of the wall 092, a damaged ground floor (UF2179), made of yellow compacted earth, was found, over which was built the wall 090 and probably also the wall 091 and is partially leaning on the wall 092. Several damaged pieces of this ground floor were found in differents places in the southern part of the courtyard, strongly suggesting that this ground floor was firstly extending on the whole area (Fig.63).

Fig.63_General view of early building discovered in room B31K



On the northern side of the wall ST090 was found a second ground floor (UF2185) made of strongly compacted red earth or mortar, which is built over a level (UF2253) made of smashed corals probably covering and levelling the bedrock. The northern edge of the ground floor might show the trace of a destroyed wall in the same line of the wall ST050 in the room Z, giving general idea of the extend of the former building. Though there is yet no firm evidence, it's possible to assume that the inside of this former building was in the north of the wall ST090, while the outside would have stood in the south, where the walls ST090 and ST091 would have been, internal division of a former courtyard.

Few postholes can be linked to this phase, possibly three in the southern part and maybe five in the north. In the south, two postholes (ST 076 and ST77) (Fig.64) are round-shaped and clearly linked with this phases as they were dug through the ground floor UF2179 and covered by the upper level, while the third one (ST78) may simply be and half-round degradation of the ground floor. In the northern part, a small and undeep hole (ST107) very close to the wall ST090 might be seen as a gudgeon for an assumed door that would have stood there. Three other postholes (ST112, 114 and 121) round-shaped and deeper make a regular line roughly parallel with the wall ST 090 and the forementioned assumed saved wall ; a fourth one might be but it was destroyed by a late pit. In the north-eastern corner of the supposed extend of the internal space, a small hole might have been a second gudgeon. Finally, a square undeep pit (ST111) is quite probably part of the same phase of occupation but its function is still unknown.



*Fig.64_Postholes ST
076, 077 and 078*

2. Big building

Building B21 is located south of the square, opposite the mosque B19. It is a large structure, almost squarish. $31 \times 25.50 \times 27.5 \times 28$ m. Only the north-east corner get in the building, it's probably because B21 was built after the building B20 and the plan of B21 was adjusted in terms of the plan of B20.

PHASE I (fig.65)



*Fig.65_General plan
of the building B21 in
phase I*

B21 was built on the bedrock. The walls are generally 70 cm thick and 2m high on average, with facades made of angular limestone blocks roughly set in a thick orange mortar.

The first occupation is set up directly on the bedrock or for some parts on a thin backfill to readjust the level. The floor is a compact and orange earth level in all rooms except in room Y, E, F, G and T. No trace of an occupation layer tied to this phase. The most likely assumption is that everything has been cleaned out before setting up the second occupation.

For this phase, three principal entrances were determined, one in the south wall of room F, one in south wall in room E and one in north wall of room P (Fig.65).

The rooms E, Y and D form a separate space in the general layout of B21. The entrance is a door of 1.70m width to go in the room E (12.5 m²), an intermediary door (today disappear) in the wall ST 001 (Fig.66) gave access to the room Y. This room form a square of 18 m² with an additional space in the north-eastern corner, it was maybe a space for racks. In the northern wall (ST 008/009) a door of 1 m width



*Fig.66_Wall ST 001
and probably rest of
the door between room
B21E and B21Y*

is used to go in room D, a rectangular space of 14.20 m².

The question about the room C is always irresolute, indeed there is no door in this room. It's not possible to determine if this room is part of this set of rooms or not.

Any opening were discovered to go to the courtyard H or the entrance in room F.No layer of occupation have benn discovered in association with this space, so it's not possible to determined the function of these rooms.

Just before and at the east of the second entrance a little room (T) takes place of 5.90m².

The second entrance take place in the southern wall of room F, just next to the previous door. It makes access to a rectangular space of 12.85 m², at the east a door of 1.20 m in the wall ST 013 makes access to a same shape area (room G). A third door, in the northern wall (ST 012) of room F open on room H. This one is a large rectangular space of 57 m². From this room it's possible to go to the room Z (8.5 m²) which is located in the center of B21.

In the north-western corner of the room H an another door open on the room V, a little space of 9 m² whereby make access to the room M and B.

Again from room H a corridor (I) make access to an external room (AB). A pit (ST 071) (Fig.67) is dug in the middle of the passage. The organisation of room AB give any orientation for the interpretation of its function. The cooridor leads to a rectangular space with a little square space built in the south-eastern corner.Last door in room H, at east, open on the biggest room (room K) of the building with 83 m². An hinge bearing (ST 079) (Fig.68) takes place to the north of the door, on the room K side. In these were discovered the fondations of the earliest building (supra). After the complete demolition of the former building and the levelling of its remains, which the main part of elements were probable reemployed as they weren't find during excavation, all the formentioned structure of the earliest building were totally covered by a homogene level of gravels (UF 2102) that levelled all the southern half of the courtyard. Over this level was then put

Fig.67_Pit ST 071 in the middle of the corridor B21I





Fig.68_Hinge bearing (ST 079) takes place to the north of the door, on the room K side

down a level (UF 2140 and UF 2202) made of brown compact earth which wasn't found over the whole extent of the excavation, but could be seen as an intermediary ground level. This level is partially covered by different pieces (UF 2201, 2205 and 2206) of what seems to be the same level made of charcoal and ashes that probably marks the occupation associated to the ground floor UF 2140/2202. From the room K it's possible to go in room L with a door in the eastern wall (ST 054). This room is a rectangular space of 49 m². One first floor has been exposed (UF 2247, UF 2251), covering presumably the whole room. The compact orange floor is directly set up on the bedrock, or for some parts, on a backfill installed to level the ground. As the other rooms, this floor has probably been cleaned out to set up the new occupation.

Associated to this surface, two small walls (ST 119) were built directly over the bedrock, in the southern sounding. In a same line, they probably marked the entrance of a back room.

Also, from the north-eastern corner of the room K another door, 1.20 m width, open on room U with a superficie of 18.5 m².

In the extension of the room Z takes place the room X, a space of 8 m². Like the room C no door have been discovered and also no occupation layer for this phase. Only a post-hole in the south-western corner defined the occupation.

In the eastern wall (ST 098) of room V a door open on room M. During the excavation it was observed that the wall ST 027 was destroyed in its southern part. During the first phase of occupation was probably longer. The same observation was made for the wall ST 022, which would extend to the east. So it seems that these two walls had,

in the original construction, formed an angle in the south-east of the room W, which is not the case in the second phase of occupation (Fig.69). No wall marks the separation between the room M and the

Fig.69_First phase of construction of wall ST 027



room O, so it was probably the same L-shaped space of 56.9 m² (29.7 m² + 26.8 m²). Remarquable thing in this area the door making access to rooms AA and N is raised comparing to the floor. Indeed a masonry (ST 126) take place, in room M, just down the threshold (ST 124). This masonry could be a residual of a staircase (fig.70)

Fig.70_Residual of staircase ST 126



Room AA and N seem to be the same space, indeed no door was discovered between them. So it makes a L-shape space of 24.70 m².

In the western wall of room V (ST 014) a door (1 m width) open on room B which is a space of 17.50 m². This room is divided in three different spaces by light walls (ST 017) (Fig??). There is no precise explanation about the function of these different spaces. In the northern wall (ST 018) of the room a door lead to the room A which is an area of 38.50 m². The door (1 m width) to room P is in the eastern wall (ST 082). The occupation floor of room P is made with packed grey earth, containing ceramic shreds and fishbones. It may be was several thin floor layers but they were too damaged to be separate during the excavation.

The room Q was probably a corridor during the first phase of occupation to go to room W.

The principal entrance for the north part of the building is located in room P. It's a large opening of 1.60 m width.

Concerning the external area the most remarkable discovery is the large street (2.5 m width) running along the wall ST 033 at the east of the building (Fig.71). It's delimited by a structure (ST 100), parralel to the wall ST 033, which is probably a kind of side walk.



*Fig.71_Street running
at the east of B21*

PHASE II (fig.72)

The most important things to know about the second phase of occupation of B21 is the banking of the biggest part of the B21 area and the new layout of space.

Concerning the banking of, it was identified everywhere except in room T. On the entire surface the backfill is nearly the same that is to say a mix of pebbles and gravels in a sandy beige matrix. Important thing to note, the general backfill contains a very important quantity of



Fig.72_General plan of the building B21 in phase II

pottery, sometimes entire, but the study is foretold for the next season of excavation. In most of the room no occupation layer was found in relation with these second phase excepted for room L, M and Z.

- Room L :

The second phase starts with the set up of a backfill (UF 2194 = UF 2197), covered by a floor (UF 2224 = UF 2252) which is quite unclear in some parts of the room and movable. In the same time, a little Madbasa (2.50x1.10 m with six channels) (Fig.73) has been built in the “back room”, in the south-western corner, between the main walls and



Fig.73_Madbasa in room B21L



Fig.74_Wall ST 119 in room B21L

the small wall ST 119. This construction is associated with a thin floor (UF 2193), (only one step over the floor UF 2224) appearing at the entrance created by the two small walls ST 119 (Fig.74). It seems that the two floors worked together, one tied to the Madbasa, one covering the rest of the room.

In this part of the room, a thin layer identified as an occupation (UF 2223) has been excavated which concentrated many pottery pieces and some ashes.

In the same time, in the northern area of the room, one small wall (ST 120) has been exposed associated to the floor UF 2252. It consists in a stone wall without binding, counting only one level of construction. It lays on a backfill (UF 2197).

- Room M :

The second phase consisted in, firstly, backfilling the floor UF 2097. Several layers of backfills have been exposed. Directly over UF 2097, a layer of compact off-white pebbles and above it, small gravels with a pink-orange color earth and some inclusions of charcoals lie.

In the eastern part of the room, a digging has been observed (UF 2136), which function is probably a foundation trench in order to set up a construction (UF 2134), the later threshold, against the wall ST 127.

The eastern wall of the room (ST 127) was probably destroyed on purpose at this time. These combined created a new free space which function was another entrance to the room M. The newly door formed with the threshold (ST 125, UF 2134) was put side by side to the previous one (ST 124), creating thus a “double-door”, both being used in the same time (Fig.75).



Fig.75_Double-door in room B21M

Then, the floor (UF 2067) has been set up, covering backfills and previous structures. It's clearly associated to the functioning of the double door. Over this floor, a thin occupation layer has been excavated (UF 2113).

On the northern part of the room, a wall (ST 057) was built above the compact off-white floor in room O (UF2144) linked to the newly set up floor in room M (UF 2067). The wall ST 057 is made up of big rocks, only two level of construction are still visible, leaning on ST 056. This construction function is quite likely to limit again the passing from room M to room O.

- Room Z :

The second phase of occupation is the more instructive. The room Z gets its actual walls, creating a small rectangular room (ST053-024-025-039). Firstly, we observe a thick layer of gravels filling in a grey sandy earth (UF2117), and on the top a floor consisting of a very thin layer of packed earth (UF2184). On the floor we count several structures, concentrated on the north part of the room. The only one on the southern part is a hole filling with coral stones in a grey pink mortar. There is four post holes (ST068-069-070-063)(fig.76), made in the earthen floor forming a square, may be to put wood posts for a light



Fig.76_General view of room B21Z

roof.

In the centre of this square area there is a large hole, 15cm deep (ST062). There are also two interesting structures on the east: a white stone polished, seems like marble, and a medium size hole, 20cm, deep, with a long stone to fix the content (ST059). Another important element to underline is the wood negative trace, near the wall ST024, with a strange form (ST062). We have to pursue our researches to understand what it forms, if the artisanal meaning of these structures is clear, we cannot yet say which.

During this phase, outside of the room, a pediluve was build (ST051)(fig.77). The rectangular structure cuts the earthy floor (UF2168), a range of coral stones makes four faces and the whole was



Fig.77_Pediluve

coated with waterproof white mortar. A filling of gravel (UF2171), like in room Z, was put on the four sides of the structure to make a floor level (UF2159), which corresponds with the floor of room Z (UF2184).

After the main occupation, a new floor recovers all the room (UF 2128), it consists of sandy packed mortar, 5 cm thick. The former artisanal activity was partly release, but we can notice a long rectangular hole (1.60x0.60 m), East-West axed (ST 049) (Fig.78), not very deep and just lying on the former floor. Nothing can explain the meaning of this structure. The occupation layers are not very expressive about the function of the rooms. That we can say is the backfill was put on the total surface of the building (except room T) and it was maybe mixed with the trash of the previous occupation of the building to explain the big quantity of pottery found in it.



*Fig.78_long rectangular
hole ST 049*

3. The new layout

During the first occupation of B21, the traffic was open and it was possible to go in any room without going outside. This apart for room B, D and E which formed a separate set (see supra).

It seems that for the second occupation general space has been divided into three additional parts. Indeed three doors were sealed after installation of the embankment, it is the door between room H and room V (ST 122), between room V and room B (ST 081) and, the entrance into the building located room P (ST 083) door was sealed and drill in room A (Fig.79). So there is now 3 or 4 independant spaces in B21 (Fig.80).

The most probably explanation about this separation is a changing of owner, during the first phase of occupation there were probably two owner, one for rooms B, D, E and maybe C, and a second one for the rest of the bulding. During the second phase of occupation there is probably 4 owners, one always for rooms B, D, E, C and probably J, a second one for rooms T, F, G, H, Z I, K, L, U and probably X, a third one for rooms V, M, N, W, O and AA, and a probably fourth one for rooms A, B, Q and P (Fig.81). No entrance were found for this space so it's not possible to be sure that it was independant. May be a raised door could lead to one adjacent space.



Fig.79_B21 circulation during phase I



Fig.80_B21 circulation during phase II



Fig.81_Space layout in phase II

PHASE III (fig.82)

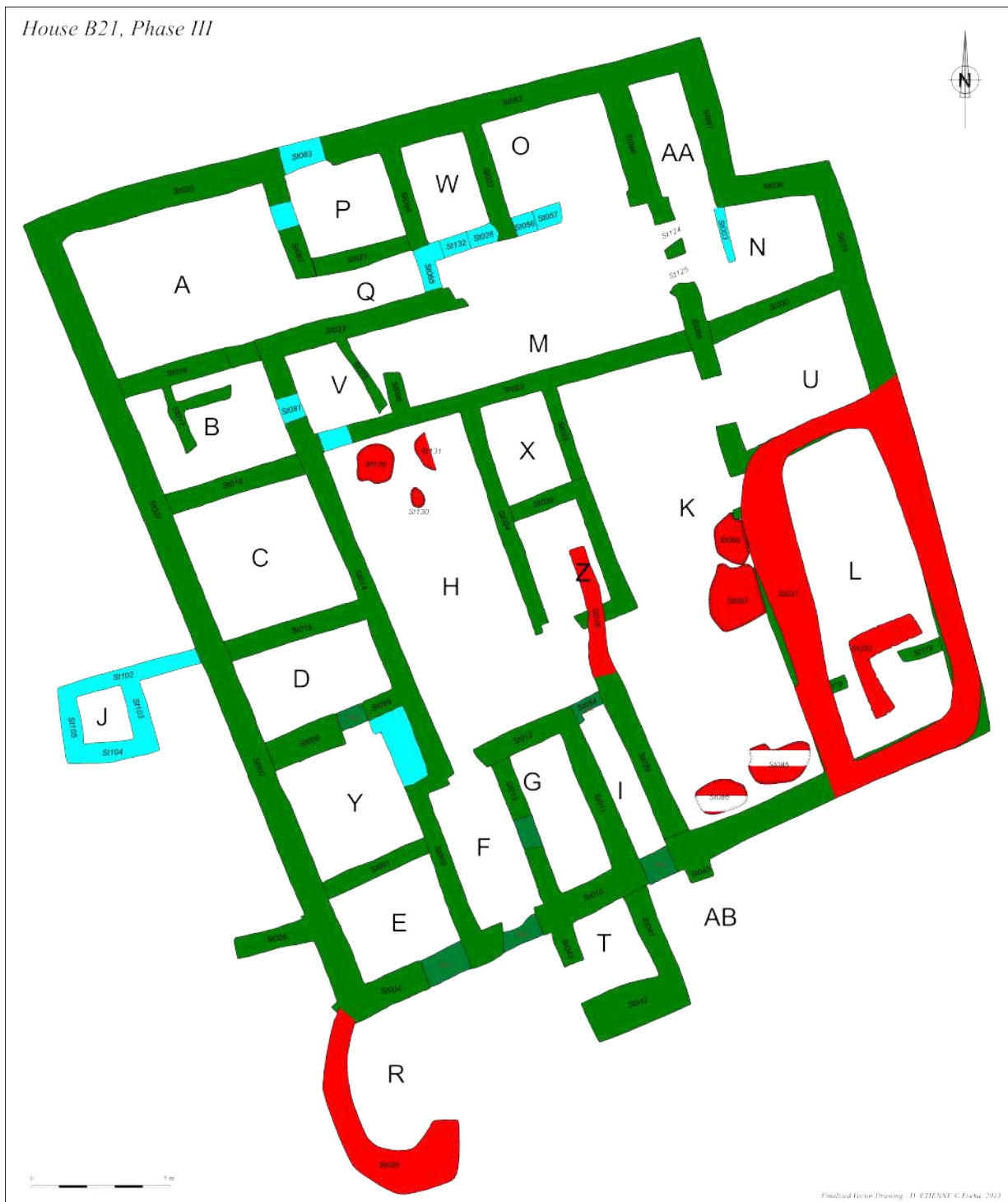

Fig.82_General plan of the building B21 in phase III

The third phase of occupation of B21 is characterized by the construction of dry stone walls especially in the room L. All walls of this room were rebuilt (ST 031) and a new space was created in the south of the room with the construction of the dry stone wall ST 032. In addition to the facilities of the room L, a dry stone wall was built to block the passage between rooms H and K creating an enclosed space

consisting of rooms K, U and L.

Outside the building at the south-west angle, an oval space has also been created, it is characterized by a dry stone wall (ST 026) of variable width (from 60 cm to 1.10 m).

This construction seems to be some enclosure for animals and could correspond to a late occupation, probably by Bedouin people in 19th or 20th centuries.

The pits (ST 129, 130, 131, 085, 086, 087, and 088) correspond probably to an extraction of materials in order to build the dry stone walls.

The house B20 sets in the eastern front of the small square separating B21 from the small mosque B19 (fig.83). According to the topographical kite-survey made in 2010, it was supposed to be a long rectangular building oriented east-west, separated on the south from another building by a narrow street. Two small soundings were opened (fig.84). The first one sets on what was supposed to be the south-western corner of an internal room along the

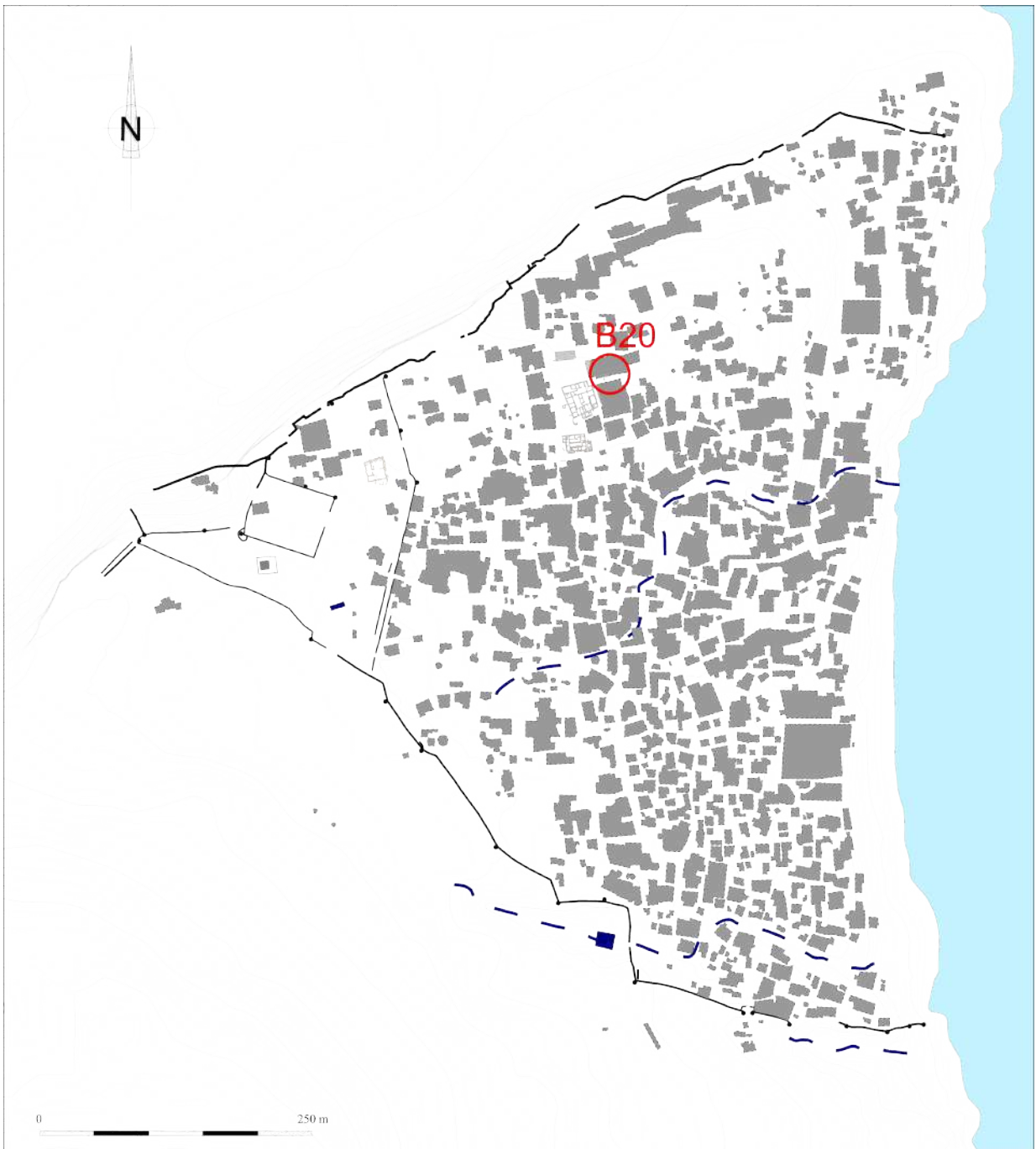

Fig.83_Location of B20

southern front of the house. The second one sets on what was supposed to be the street. The purpose was to estimate the thickness of the collapse and the archeological layers, and to find some evidences about the use and length of the occupation. Though the soundings didn't really change the assumptions of the topographical survey, they show some features and modifications that were not expected.

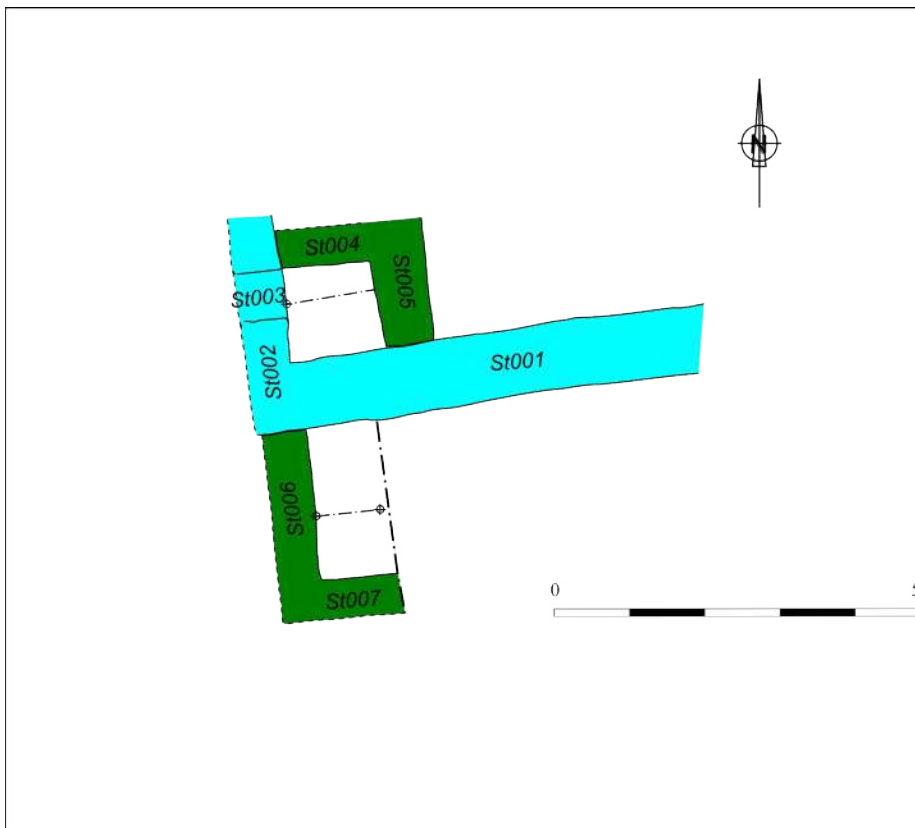

Fig.84_Plan of the sounding in B20

The first sounding

After a short ground cleaning, the wall ST 001 running west to east, was discovered and unearthed on a length of 6m. This wall, made mainly of limestone rocks bonded with earth mortar, is around 0,90m wide and preserved for a little more than 1m. Shortly after the starting of the excavations on the supposed internal side of the wall, a second wall, which wasn't visible on the surface, was discovered. This wall, ST 002, is perpendicular and sets at the western end of the wall ST 001. It's also mainly made of limestone rocks bonded with earthen mortar but only 0,60m wide for a recognized length of 3m and a preserved elevation of more than 1m. Around the middle of this wall, a sudden change in the elevation may suggest a threshold (ST 003), but the excavation must be expanded there to confirm this hypothesis. Both walls are clamped and, as we'll see, belong to the first phase. According to the aerial survey, the wall ST 002 is not the western external wall but an internal one ; for this, the excavations can't yet confirm or invalidate.

Two other unexpected walls were soon discovered, changing radically the face of what was supposed to be a large open room. Both walls are

made of small limestone rocks poorly bonded with earthen mortar and clamped. The wall ST 005 runs south-north and leans on the northern side of the wall St001. The wall ST 004, perpendicular to the previous one, runs west-east and also leans on the eastern side of the wall ST002, just about the threshold ST 003. Subsequently, those two walls create a little room, about 1m square, reachable through the threshold ST 003.

The lower archeological level is a strongly compact backfill (UF 2525) made of earth and gravel, leveling the bedrock and over which the walls ST 001 and ST 002 were build. This backfill is completely covered by a thin level of ashes (UF 2527) but it's really hard to see if this level runs under the walls or leans on them. This level could either belong to a scarce occupation prior to the building of the house or to a first short phase of occupation.

Over it, a thin level of light-brown compact earth (UF 2528) visibly leans on wall ST 002 and runs under the wall ST 005 and presumably under the wall St004, showing undoubtedly that the walls ST 005 and ST 004 belong to a second phase of construction. However, the lack of consistent occupation layer running under the wall ST 005 strongly suggests that those subsequent walls were built not long after the erection of the first walls. This strong level can be seen as a floor but unfortunately no occupation layer corresponding was seen.

Above this possible floor, leaning on the supposed threshold ST 003, is a small level (UF 2523) of sandy brown earth mixed with some charcoal. This level is so soft that it can be seen as a slow windy deposit made by the opening of the threshold. Above it, covering all the internal space and leaning on all the walls is a strongly mixed layer (UF 2524), made with brown, gray, white and beige earth, many charcoals and remains of decomposed plant, presumably wood or palm leaf. The level is probably the collapse of the roof or the upper floor if there was any.

This level is partially covered by two other layers which might indicate a temporary occupation : one (UF 2530) is made of gray earth, probably hard because it was trampled and at the same height of the threshold. The second level (UF 2529) is made of ashes with few charcoals, presumably remains of hearth. Above them lies a layer (UF 2522) strictly similar to UF 2524, so it has to be assumed as the continuation of the collapse floor and roof after the temporary occupation.

Above it, covering layers and walls, lies a thick level UF (2521) made of brown and beige earth mixed with many stones of all size which has to be interpreted as the collapse of the walls, showing the final desertion of the room.

The second sounding

The second sounding was opened along the southern wall St001 over what was supposed to be a street and, subsequently on the outside of the building, but the discovery of two perpendicular walls demonstrates a more complex evolution of the area.

The first wall (ST 006), partially unearthed and running south-north, is at least 0,60m wide and 2,50m long for a badly preserved elevation around 0,80cm. The second wall (ST 007), running east-west, is at least 0,50cm wide and 1,50m long but only 0,40m high. Both walls are clamped and made of limestone rocks poorly bonded with earth mortar, and the western wall (ST 006) is visibly leaning on the wall ST 001.

The lower level (UF 2532) is a backfill over the bedrock and, though it is higher, must be the same as UF 2525 on the north of the wall ST 001. Over it is a thin level of compacted brown earth (UF 2531) covered by a thin level (UF 2533) made of brown softer earth mixed with ashes and charcoal which must be an occupation level covering a ground floor. Above this occupation level are built the walls ST 006 and ST 007, demonstrating that those two walls were built in a second phase. Finally, covering all levels and walls is the level of collapse (UF 2526) of the walls, made of brown earth mixed with many stones and rocks.

The discovery of those walls, on the supposed outside of the building, seems to indicate that the supposed narrow street does not exist and might rather be an internal corridor, but such conclusions could be a mistake. In fact, the thin level of compacted earth (UF 2531) with the thin level of occupation above are in accordance with the idea of a street. Its floor would be poorly made compared to the floors seen inside the houses. The occupation would also have been scarcer and the circulation and the wind would have spread away elements of occupation. At some point in time, the street was closed, or at least reduced by the construction of the two walls ST 006 and ST 007. In that case, those walls could be the evidence of the addition of a small building, such as a shed, storage room or any kind of half opened outbuilding.

However, every conclusion could only remain hypothetical until the completion of the excavations.

B 19, the small platform Mosque

The B19 Mosque is a construction of simple plan, with a small prayer hall preceded by a courtyard, both are built on its own massive rectangular terrace. The terraces were built directly on the bedrock with the exception of Southwest angle where a fragment of oldest, preserved wall 45 cm high was reused like basis of the southern retaining wall.

No occupation level associated with this ancient wall was found, the level of collapse of the mosque is directly on the bedrock. The analyze of the Qibla wall showed that the Mirhab override the wall so it was probably visible from outside.

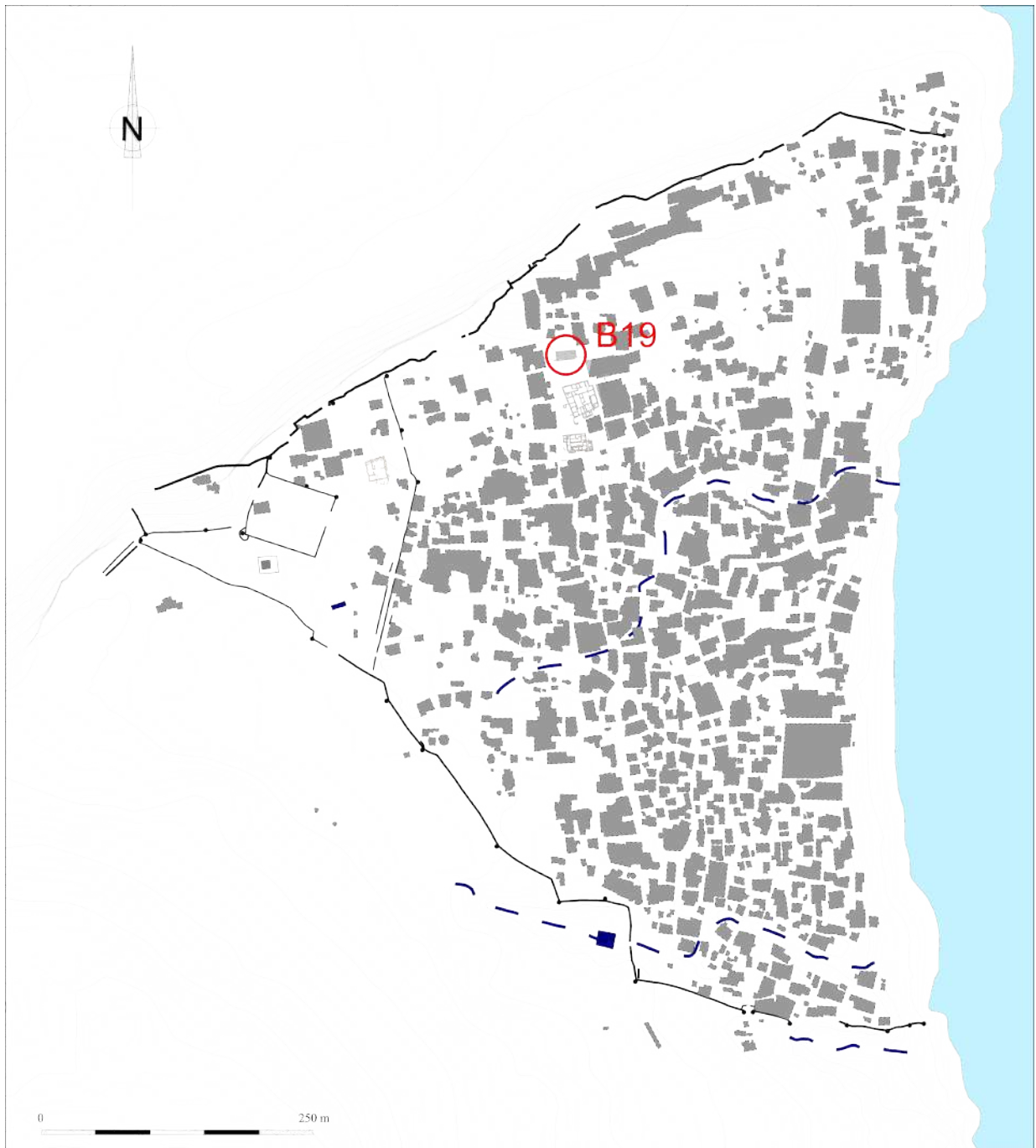

Fig.85_Location of B19

Preliminary Analysis of the faunal remains Mammals - Birds

Hervé Monchot - *Labex Resmed, PRES Sorbonne Université UMR 8167 "Orient & Méditerranée"*

The zooarchaeological study is important not only for understanding the environment of Qalhat but also to better understand the subsistence strategies of the inhabitants of the site and the sources of this diet. Such analyses will aim to better understand the development dynamics of the management and exploitation of animal resources during each phase of occupation of each settlement and then evaluating the main diachronic changes registered. But the site is still under excavation and research, and therefore some of the conclusions presented here are preliminary hypothesis. Consequently, the aim of this paper is not to attempt a detailed analysis of diet in Qalhat during the Islamic times, nor of temporal changes during the different phases of occupations but to give an outline and indicate areas of potential that can be addressed in the future phases of excavations.

The preliminary results presented here focus only on the vertebrate fauna (mammals and birds) of the Building B94 (a domestic building) and a part of the B12 building, the mosque. Tens of thousands of fish and shellfish remains will be analyzed later. But we need remind that Qalhat

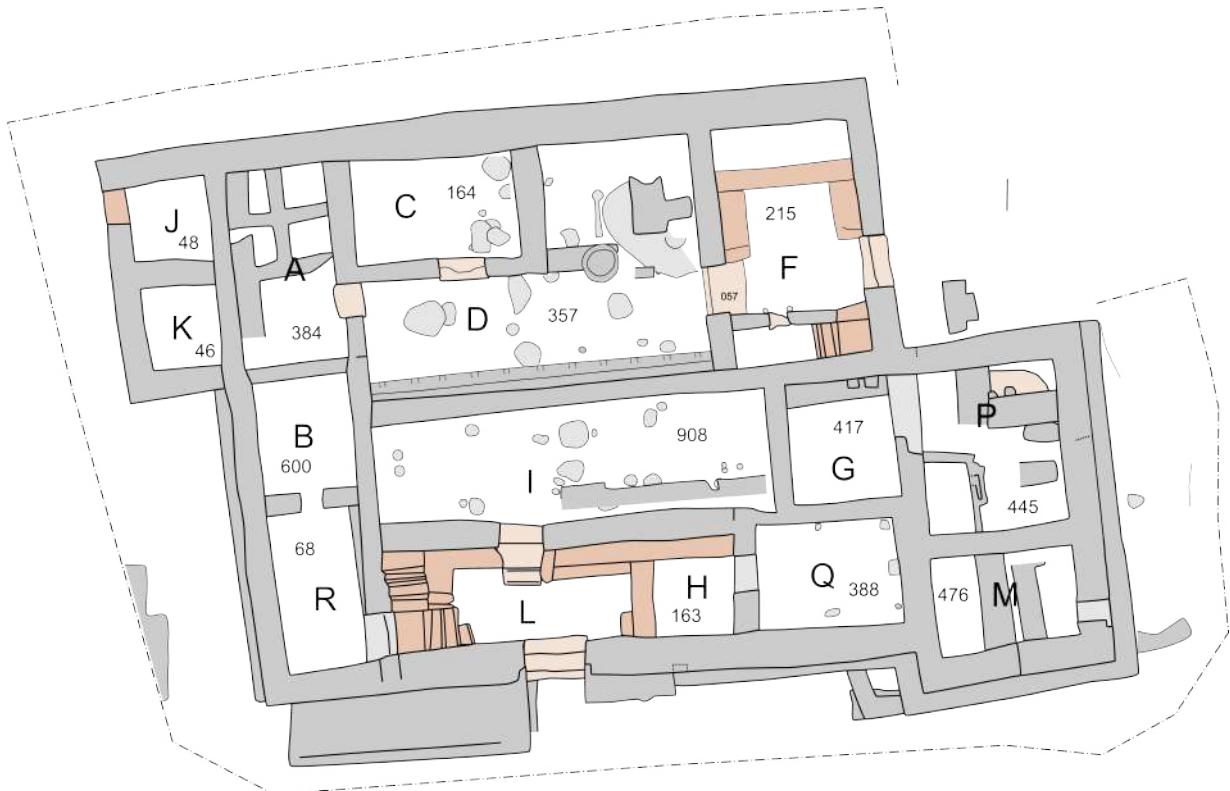

is a port and as all ports its subsistence is entirely turned towards the sea (e.g. pisces, molluscs).

The majority of the mammal bone assemblage was recorded by the author “in the field”, during a visit to Oman in 2012. Specimens which proved difficult to identify, or whose identification needed checking, were removed and taken to Paris (France) for subsequent evaluation.

Table 1 presents the overall results of analysis of Qalhat mammal/bird bone assemblage. Out of more than 5900 animal bone fragments, 4629 (78.4%) were diagnostic fragments. The greater part of the assemblage belonged to the building 94 (n= 5351). Lesser quantities were recorded from the Mosque layers at the site (n= 549). In number of identified specimens, sheep/goat dominated the assemblage followed by chicken, cat and black rat.

Finally the tables 2 and 3 present the species identification according each UF for the buildings B12 and B94 respectively. The figure 1 shows the distribution of skeletal remains in the different rooms of the B94 building. The room I is the part of the building that has the largest number of faunal remains (n= 908) following by the rooms B (n=600), M (n=476), P(n=445) and G (n=417). A rigorous analysis of the spatial distribution of bone remains will be made later.

	Number of identified specimens			
	B94	B12	TOT	% NISP
Mammals				
Sheep/Goat (<i>Ovis aries/Capra hircus</i>)	3853	357	4210	90.9
Cattle (<i>Bos taurus</i>)	21	1	22	0.5
Gazelle (<i>Gazella</i> sp.)	2		2	<0.1
Pig (<i>Sus domesticus</i>)		1	1	<0.1
Equid (<i>Equus</i> sp.)	7		7	0.2
Dog (<i>Canis lupus</i> f. <i>familiaris</i>)	11		12	0.3
Red fox (<i>Vulpes</i> sp.)		1		<0.1
Cat (<i>Felis silvestris</i> f. <i>familiaris</i>)	50	42	92	2.0
Cape hare (<i>Lepus capensis</i>)	2		2	<0.1
Black rat (<i>Rattus rattus</i>)	84		84	1.8
Whale	1		1	<0.1
Dolphin	1		1	<0.1
Birds				
Chicken (<i>Gallus gallus</i> f. <i>domesticus</i>)	172	12	184	4.0
Rock dove (<i>Columbia liva</i>)	2			
Gull (<i>Larus</i> sp.)	3		3	<0.1
Lappet-faced Vulture (<i>Torgos tracheliotos</i>)		1	1	<0.1
Bird indet.	3	1	4	<0.1
Unidentified fragment	1139	133	1272	--
Total	5351	549	5900	100

Tab. 1. Species list from Qalhat, B94+B12 excavations. (%NISP, only for the identifiable element)

1. MAMMAL SPECIES

1.1. Domesticated species

- Sheep/Goat (*Ovis aries/Capra hircus*)

Most of the caprine could only be identified (n= 4210, with 3857 in B94 and 357 in B12) as belonging generally to the category

sheep/goat. Indeed sheep and goats have been distinguished using morphometrical criteria (e.g., Boessneck et al., 1964; Helmer, 2000; Fernandez, 2001). However despite an extensive literature, the specific separation is not always easy, a large majority of the criteria are not 100% reliable and the very diagnostic elements such as horncores are generally poorly preserved. So the sheep and goat remains were placed in a combined sheep/goat category, i.e., caprine. Sheep/goat remains represent 90.9% of identified bone in the assemblage.

The figure 2 presents the anatomical profile for both buildings. Several remarks can be done:

These figures show the distribution of anatomical elements for all buildings. It will be in the future to specify them in the different room/sector of each building. This will refine the calculation of the minimum number of individuals. In addition this figure does not take into account the bone fragmentation, several elements can belong to the same bone. We observe a dominance remains of the trunk and limb,

B94

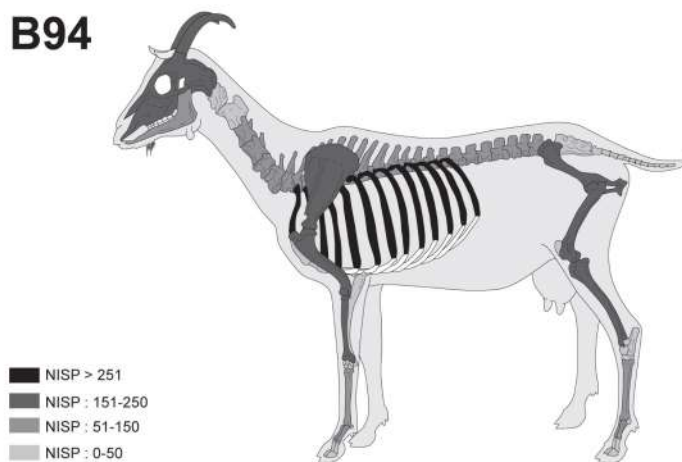

B12

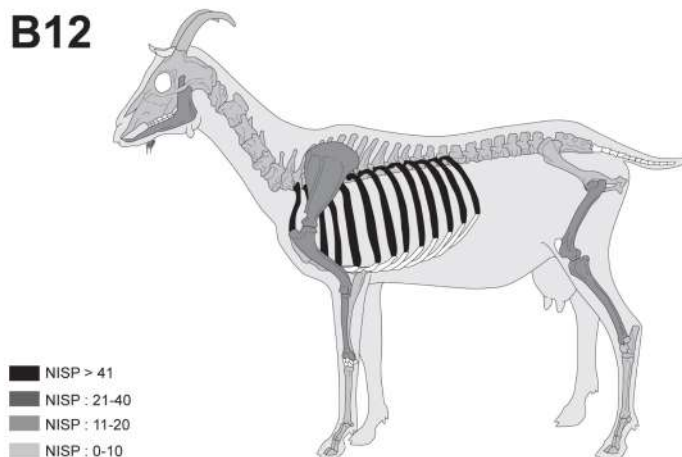

Fig. 2. Caprine skeletal representation for B94 and B12 in NISP (Number of identified specimens).

the meaty-part.

We have clearly an under-representation of the feet bones (carpal, tarsal and metapodial). Two hypotheses may explain this under-representation: (1) the bones are left with the skin at the time of skinning; (2) it was introduced on the site only the rich (meaty) pieces, the non-nutritious pieces were abandoned outside the home. More than half of the individuals are juvenile which many yearling. An accurate count of the minimum number of individuals (and the mortality profiles) present in the assemblage will be done soon because we need to take account of each sub-assemblage (rooms) representing independent deposits.

Finally it should be noted the presence of many cut marks on the entire skeleton which suggests an important caprine consumption by the inhabitants. A detailed study will help us better to understand the butchery techniques used.

- Cattle (*Bos taurus*)

Only small amounts (n=22) of cattle occurred at Qalat. It is essentially fragments of shaft of long bones (e.g., femur, tibia, metapodial). Cattle is present in the rooms B, G, H, P and in the sectors Ext. E. and W. The cattle seem to have been consumed in Qalhat. Nevertheless, its presence is marginal compared to caprine and could be explained by its strong ecological requirements (e.g., water and pasture).

- Pig (*Sus domesticus*)

Only one bone showed the presence of pig: it's a fragment of an axis found in B12 UF 1194, which level of abandonment of the courtyard of the mosque.

- Equid (*Equus* sp.)

Identifying Equid bones specifically is not easy with the recurrent distinction between horse (*Equus caballus*), donkey (*Equus asinus*) and hybrid mules. Only eleven remains, all present in B94, attest the presence of Equids: an upper right molar (UF 1443), two lower molar (UF 1672, 1825), a milked molar (juvenile), in UF 1722, an milked incisor (juvenile) in UF 1394, a complete phalanx 1 (UF 1675) and a distal end of a metapodial (UF 1898).

- Dog (*Canis familiaris*)

The dog is represented by eleven elements in B94 present in :
Room P by two fragment (right and left) of a mandible, by a shaft fragment and a left proximal fragment of a of a tibia;
Room F by a metatarsal III (young individual);
Room Q by a fragment of an humerus (young individual);
Room G by two uln represents a fragments certainly belong to the same individual;
Sector Ext. W by a right astragalus;
Sector SE (UF 1436) by two shaft fragments of radius and humerus.

- Cat (*Felis domesticus*)

Several cat remains (n=92) were identified amongst the Qalhat assemblage. According to the diagnostic criteria of Kratchovil (1973, 1976) these would appear to be from domestic rather than wild cats. Fifty cat bones were found in B94, and 42 in B12. Fourteen bones belonged to adult individuals, 36 belongs to immature individual (kitten) (Tab.4).

Forty-two bones were identified in B12. If the majority bones were single finds, in the UF 1723, 25 remains belong to an immature skeleton. The size of the long bones show that immature luvéniles belong to different age ranges (Smith, 1969, Luff and Moreno Garcia, 1995).

	Immature		Adult		Total	
	NISP	MNI	NISP	MNI	NISP	MNI
B12	22	3	20	2	42	5
B94	36	3	14	6	50	9

Tab. 4. Distribution of cat remains at Qalhat. (NISP= number of identified specimens MNI= minimum number of individuals)

Rarely abundant amongst the archaeological faunal list from in the Near and Middle east, the cat was nevertheless identified in the multi-period urban site of Bey 002 (Martyr's Square, Beirut, Lebanon, Oueslati, 2008), in Bilal al-Qadim (Bahrain, Smith, 2005), in the medieval levels at the Great Mosque in Siraf (Iran, von den Driesch and Dockner, 2002) or in the Islamic site of Al-Yamâma in Saudi-Arabia (Monchot, 2012). No traces of cut marks were found of any cat bones so it seems likely that the animals were not skinned. Probably, cats were popular pets and would also have fulfilled an important role in controlling rat and other small rodents (Beech, 2007).

The abundance of cats can be explained by the abundance of rats on the site, which is the main predator. In Egypt in a Roman building of Tell el-Maskhuta a burial of a cat was found, which had eaten at least six rats (*Rattus rattus*), remains of which were found in the stomach and in the dung balls (Driesch von den and Boessneck, 1983).

- Hare (*Lepus capensis*)

Two bone evidenced the presence of a hare on the site:

In B94 UF 1408, a right subcomplete humerus belonging to an adult, and present butchery cutmarks;

In B94 UF 1830, a left scapula from a juvenile individual.

- Black rat (*Rattus rattus*)

The identification of black rat (n= 84), rather than brown rat (*Rattus norvegicus*), was confirmed by the morphology. Rat is present in many UF in B94 (see Tab. 2).

The rat is frequently found on archaeological sites in the Middle Ages of the Arabian Peninsula. In addition many bones showed gnawing

marks, which its a sign of an intense activity of these rodents on the site.

1.2. Wild species

- Fox (*Vulpes* sp.)

A complete right femur was identified in building B12 (UF 1309). The femur was assigned, on the basis of its size (Tab. 5), as belonging to red fox (*Vulpes vulpes*) rather than the smaller Ruppell's sand fox (*Vulpes rueppellii*) or Blanford's fox (*Vulpes cana*) both of which are known to occur in the region at the present day (Harrison and Bates, 1991).

	GL	Bp	SD	Bd
Qalhat B12 1309	108.5	21.4	7.6	17.9

Tab. 5. Dimensions in millimeter of fox's femur (according to Von den Driesch, 1976) (GL= greatest length; Bp = Breadth of the proximal end; SD = smallest breadth of diaphysis; Bd= Breadth of the distal end)

It is interesting to note the presence of many cut marks made certainly by a knife on the shaft portion of the bone, which displays a sign of meat removal (Binford, 1981).

It is not rare to find the remains of foxes in the archaeological assemblages of this region and has been mentioned for example in the historic part of the Islamic site of Dûmat al-Jandal (Monchot, in press) or in late Islamic site of al-Yamama (Monchot, 2011). The fox is a scavenger species lurking around human settlements in search of garbage, but it well could be hunted for its fur or simply eaten.

- Gazelle (*Gazella* sp.)

Two bones could be identified as belonging to gazelle (*Gazella* sp.): a right proximal metatarsal (B94 1835) and a distal metatarsal (B94 1898). It was not possible to precise species which they belonged: *G. gazella*, *G. dorcas* or *G. subgutturosa*, as none of the anatomical elements represented were complete enough or particularly morphologically diagnostic. Never abundant, the gazelle is very often mentioned in archéologiques site of the Arabian Peninsula, the Mediterranean to the Indian Ocean.

1.3. Marine mammals

- Dolphin (*Delphinus delphis*/*Tursiops truncatus*)

A vertebra (Fig. 3) belonging to a dolphin has been identified in B94 UF 1834. It is not rare to find some dolphin remains on coastal site in the Arabian Peninsula (e.g., Smith, 2005:220).

Whale

Like the dolphin and in the same UF, a vertebra belonging to a whale has been identified in B94 (Fig. 4).

*Fig. 3. Dolphin
vertebra found in B94-
1834.*



*Fig. 4. Small whale
vertebra found in B94-
1834.*



2. BIRDS

- The Chicken (*Gallus gallus*)

With 184 remains, 172 in the building B94 and 12 in the mosque B12, the domestic fowl (chicken) is the second most represented species on the site. The remains included bones from males (presence of spurs), females and immature birds (immature bones, n= 44, 23.9%). All the skeletal elements were identified with a clear predominance of leg

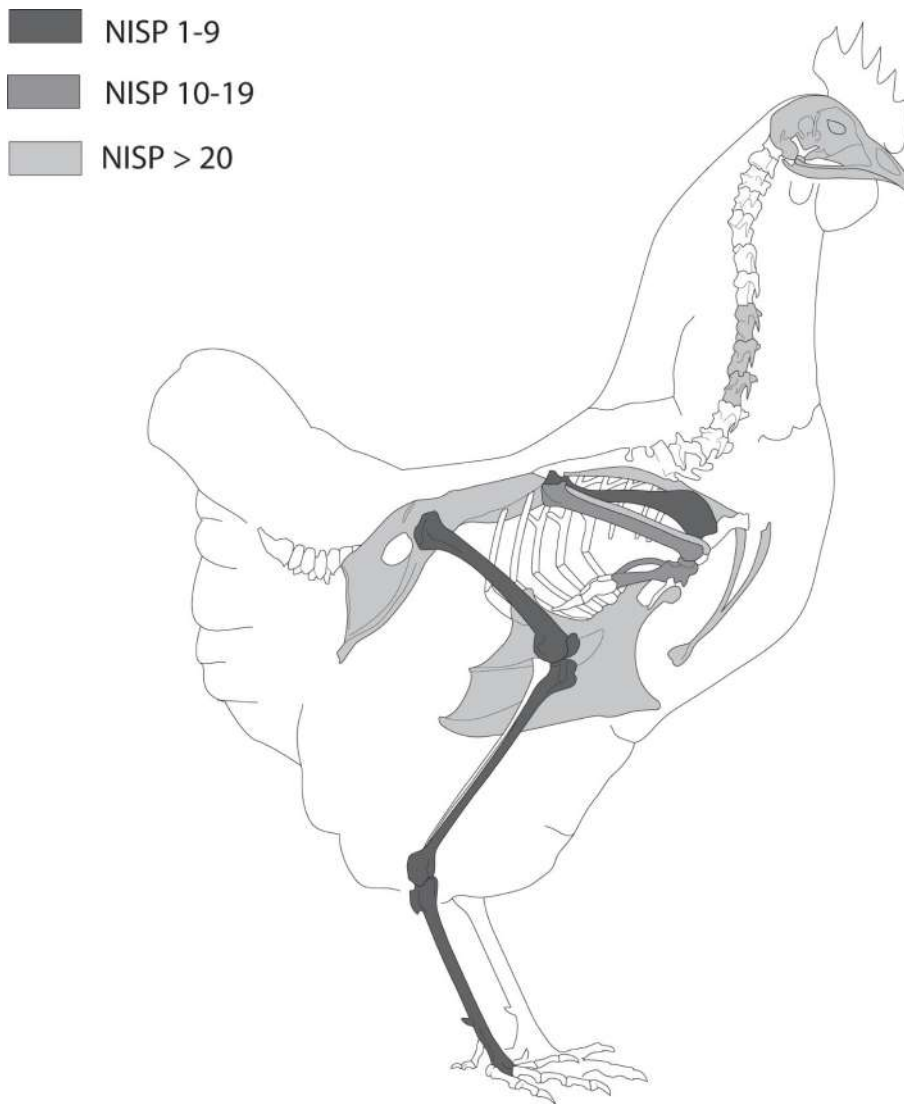

Fig. 5. Chicken bone skeletal representation (B94) in number of identified specimens (NISP).

bones and wing bones (Fig. 5). The anatomical profile indicates that undoubtedly the bones represent the waste from entire birds.

The butchery is confirmed by the presence of cut marks, which were identified on one femur, three humerus or three tibiotarsus. Eggshell fragment were identified in B94 1746 (room G), 1830 (room Q) and 1681 (room B). The spatial distribution as the measurements of chicken bones are routinely taken for future analysis.

- The rock dove (*Columba livia*)

Two bones (a left proximal humerus found in B94 1425 and a furcula found in B94 1982) were confirmed with the rock dove or common pigeon in size. It's a species very common largely found in the coastal area. The rock dove lives on cliffs and rocks, on mountains and hillsides where it nests in rock crevices or caves.

- A gull (*Larus sp.*)

A proximal fragment of a right humerus of a gull and a coracoid were identified in B94 1671. A carpometacarpus found in B94 1799 belongs certainly to a gull. The morphology and size of these bones are close

to that observed in the European Herring gull (*Larus argentatus*).

- The Lappet-faced Vulture (*Torgos tracheliotos*)

One right distal humerus (Bd= 46.6; Dd=24.8, Fig. 6) found in B12 (UF1102) belongs to the lappet-faced vulture, rare species never mentioned in archaeological sites.

Fig. 6. Distal humerus of the Lappet-faced Vulture (Torgos tracheliotos)

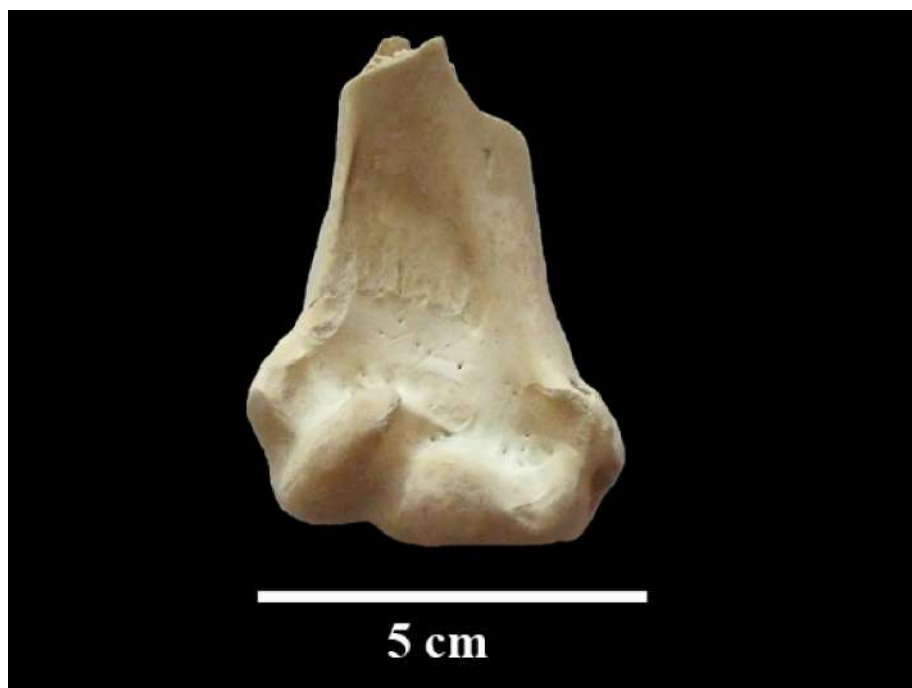

This vulture prefers to live in dry savannah, thornbush, arid plains, deserts with scattered trees in wadi, open mountain slopes. They are usually found in undisturbed open country with a scattering of trees and apparently prefer areas with minimal grass cover. While foraging, they can wander into denser habitats and even into human habited areas, especially if drawn to road kills. They may be found in elevation from sea-level to 4,500 m

This humerus presents two fine and short cutmarks just above the epicondylus dorsalis. It is difficult to imagine a vulture consumption, scavengers species, by the inhabitants. Vultures could be exploited for other resources than food, such as skin, feathers, claws, and raw bone material, and perhaps had a ritual use (Solecki and McGovern, 1980; Gourichon, 2002).

3. SPECIAL CASE: THE ROOM M OF THE BUILDING B94

Only five UF were delivered some faunal bones in the room M for a total of 476 remains. 85.5% of this material is represented by caprine, followed by chicken (2.5%) (Tab. 6).

In agreement with the data of stratigraphy and excavation, it is justified to consider this material as a single unit. The bone assemblage is clearly dominated by sheep/goat (84.9%), followed far

UF	Sheep/Goat	Chicken	Cattle	Horse	Indeterminate	Total
1434	16	1			3	20
1443	248	8	1	1	33	291
1451	112	2			22	136
1471	17					17
1492	11	1				12
Total	404	12	1	1	58	476

Tab. 6. Faunal species identified in the room M of the building B94.

behind by chicken (2.5%).

The chicken (*Gallus gallus*) was identified by 12 bones which represents two individuals (one adult and one juvenile): one right complete carpometacarpus; one complete left coracoid; one complete left humerus; one sternum fragment; one pelvis (synsacrum) fragment; two tarsometatarsus, (one complete right and one left proximal fragment); two distal extremities of a tibiotarsus (one left, one indeterminate); two ulnae (one diaphysis fragment, one left proximal left extremity) and one complete vertebrae. One upper molar represents the horse while the cattle is represented by a fragment of ventral shaft of the tibia. It should be noted in this piece the absence of intrusive animals like rodents (rat) or carnivore (cat, dog) as can be seen also in other parts of the building. This absence could be explained in the case of a closed room. Four hundred four items for a minimum of 16 individuals represent the caprine remains. The skeletal representation is presented in the table 7. We can note a total absence

	Left	Right	Ind/NA	Total	MNI	Cutmark
Skull fragments			18	18	4	
Maxillary	3	4		7	4	
Mandible	7	11	5	23		7
Isolated teeth	5	6		11	--	
Rib			66	66	2	
Cervical vertebra			13	13	2	2
Thoracic vertebra			12	12	1	3
Lumbar vertebra			17	17	2	3
Vertebra indet.			1	1	--	
Sacrum			5	5	2	1
Sternum			1	1	1	7
Scapula	20	12	5	37	16	7
Humerus	15	14	3	32	13	6
Radius	9	14	2	25		3
Ulna	3	1		4	3	1
Metacarpal	5	1		6	5	
Pelvis	6	9	12	27	8	7
Femur	15	21		36	14	
Tibia	15	15	4	34	11	1
Talus	2			2	2	
Calcaneus	2			2	2	
Metatarsal	3	1	1	5	3	
Metapodial			1	1	--	
Long bone			19	19	--	
TOTAL	110	109	185	404	16	48

Tab. 7. Caprines skeletal profile (Room M, building B94) in NISP (Number of identified specimens) (Ind/Ni = impair or indeterminate; MNI= Minimum Number of individuals; Cutmarks= number of element showing an anthropogenic action like a cutmark).

of phalanges, and a virtual absence of feet elements such metapodials, tarsus, carpal (e.g., non-nutritious part); an under-representation of the trunk (vertebrae, ribs). The cut marks are present signs of disarticulation and filleting. They are found both in adults than juveniles.

Few long bones are complete among the assemblage and the table 8 presents the fragmentation of the long bone for the adult and juveniles individuals. We can note the presence of numerous yearlings and even very young individual (one month with the unfused proximal metacarpal, Tab. 9). The presence of lambs and kids can be explained by the fact that they represent tender meat, the better meat.

	HUM			RUL			MTC		FEM		TIB			MTT			
	L	R	I	L	R	I	L	R	L	R	L	R	I	L	R	I	
Fused bone																	
Complete/Subcomplete	1	1		1	1		1									2	
Proximal extremity	2	1		1	2				2	5	4	2					1
Shaft					1	2						3	3				
Distal extremity	7	5			3				1	6	4	1					
Unfused bone																	
Complete metaphysis	1	1		1	3		1		2	2		2				1	1
Proximal metaphysis									6	4	6	5					
Proximal epiphysis	3	1	3						3	0	1	1					
Distal metaphysis		1		4	3		3	1	1	2		1	1	1			
Distal epiphysis	2	1		1						2							
MNI	13			10			5		14		11			3			

Tab. 8. Long bone fragmentation of caprine from room M

(HUM=humeral; RUL= radio-ulna;

MTC= metacarpal; FEM= femur; TIB=

tibia; MTT= metatarsal)

Age stage	Age (months)	Epiphyseal fusion	Unfused	Fused	% Unfused
1	0-1	Metacarpal proximal	1	1	50.0
1	0-1	Metatarsal proximal	2	3	40.0
1	10	Humérus distal	6	14	30.0
1	10	Radius proximal	4	5	44.4
3	18-24	Tibia distal	4	5	44.4
3	18-24	Metacarpal distal	4	1	80.0
3	20-28	Metatarsal distal	3	2	66.7
4	30-36	Femur proximal	17	7	70.9
4	36	Radius distal	12	5	70.6
4	36-42	Humerus proximal	9	5	64.3
4	36-42	Tibia proximal	15	6	71.4
4	36-42	Femur distal	7	9	43.8

Tab. 9. State of fusion of caprine bones from Room M according to Barone (1986) expressed in NISP.

B94 is a domestic house and not a farm, then it is difficult to explain such slaughter profile (herd exploitation). It is possible that not so far from the building B94 there is sheepfold, which could have provided many young individuals to the inhabitants of B94. Another explanation to explain this fact is that these people represent a rich class that were easily catch young animals.

REFERENCES

Beech, M. 2007. The large mammal and reptiles bones. In, Poulter, A. (ed.), *Nicopolis ad Istrum III: A late Roman and early Byzantine City: the Finds and the biological Remains*. Oxbow books, Society of Antiquaries of London, Reports of the Research Committee of the Society of Antiquaries of London, 67, pp. 154-197.

Binford, L.R. 1981. *Bones, Ancient Men and Modern Myths*. Academic Press Inc, 320 p.

Boessneck, J., Muller, H.-H., Teichert, M. 1964. Osteologische Unterscheidungsmerkmale zwischen Schaf (*Ovis aries*, Linné) und Ziege (*Capra hircus*, Linné). *Kuhn-Archiv* 78.

Bökönyi, S. 1993. Animal husbandry, hunting and fishing in the Junayz area : a basis of the Human Subsistence. In, Buitenhuis H., Bartosiewicz L., Choyke, A. (eds), *Archaeozoology of the Near East III*. Groningen Center for Archeological Research and Consultancy (ARC publication 18), pp. 99-102.

Driesch von den, A. 1976. A guide to the measurement of animal bones from archaeological sites. *Peabody Museum Bulletin* 1. Peabody Museum of Archaeology and Ethnology. Harvard University
Driesch von den, A., Boessneck, J. 1983. A Roman cat skeleton from Quseir on the Red Sea Coast. *Journal of Archaeological Science* 10: 205-211.

Driesch von den A., Dockner, A. 2002. Animal exploitation in medieval Siraf, Iran, based on the faunal remains from the excavations at the Great Mosque. *Bonner zoologische Beiträge*, 50(3): 227-247.

Fernández H. 2001. *Ostéologie comparée des petits ruminants eurasiatiques sauvages et domestiques (genres Rupicapra, Ovis, Capra et Capreolus): diagnose différentielle du squelette appendiculaire*, Thèse de Doctorat inédite, Université de Genève.

Gourichon, L. 2002. Bird Remains from Jerf el Ahmar, a PPNA Site in Northern Syria, with Special Reference to the Griffon Vulture (*Gyps fulvus*). In H. Buitenhuis, A.M. Choyke, M. Mashkour & A.H. Al-Shiyab (éds), *Archaeozoology of the Near East V*. Proceedings of the 5e international symposium of ASWA, Amman, June 2000.

Archaeological Research and Consultancy (Publicatie 62), Gröningen, pp. 138-152.

Harrison, D. L., Bates P. J. J. (1991). The Mammals of Arabia Kent: Harrison Zoological Museum.

Helmer D. 2000. Discrimination des genres *Ovis* et *Capra* à l'aide des prémolaires inférieures 3 et 4 et interprétation des âges d'abattage: l'exemple de Dikili Tash (Grèce). *Ibex, Journal of Mountain Ecology* 5: 29-38.

Kratochvil, Z 1973. Schadelkriterien der Wild-und Hauskatze (*Felis silvestris silvestris*) Schreb. 1777 und *F.s.f. catus* L. 1758). *Acta Scientiarum Naturalium Academiae Scientiarum Bohemoslavacae* VII, 10, 1-50

Kratochvil, Z 1976. Postkranialskelett der Wild-und Hauskatze (*Felis silvestris* und *F. lybica f.catus*). *Acta Scientiarum Naturalium Academiae Scientiarum Bohemoslavacae* X(6), 1-43

Luff, R.M., Moreno-Garcia, M. 1995. Killing Cats in the Medieval Period: An Unusual episode in the history of Cambridge, England. *Archaeofauna* 4, 93-114.

Monchot, H. 2011. Zoo-archaeological study. Preliminary Report. First campaign of the Saudi-French mission in Al-Yamāma - Al Khraj area - 20 september-21 October 2011, pp. 72-74.

Monchot, H. 2012. Preliminary study of the animal bones at al-Yamāma. Preliminary Report. Second season of the Saudi-French mission in Al-Yamāma - Al Khraj area - 11 november-18 december 2012, pp. 66-72.

Monchot, H. In press The faunal remains: preliminary results. In, Charloux G., Loreto R. (Eds.) *Dûma II. Report of the Saudi-Italian-French Archaeological Project at Dûmat al-Jandal (Saudi Arabia)*. Saudi Commission for Tourism and antiquities.

Oueslati. T. 2008. Spatial fluctuation of food habits in byzantine Beirut (Bey 002, Bey 028, Bey 115), *Archaeozoology of the Near East VIII*, TMO 49, Maison de l'Orient et de la Méditerranée, Lyon, 629-640.

Smith R.N. 1969. Fusion of ossification centres in the cat. *Journal of Small Animal Practices* 10:523-530.

Smith I. 2005. The mammal, Bird, Reptile and Molluscs remains. In, Insoll, T. (ed.), *The Land of Enki in the Islamic Era. Pearls, Palms and Religious identity in Bahrain*, London-New-York-Bahrain, Kegan

Paul, pp. 193-231.

Solecki, R. L., McGovern, T.H. 1980. Predatory birds and prehistoric man. In, Diamond S. (ed.), Theory and practice: essays present to Gene Weltfish, Mouton, The Hague, Netherlands, pp.79-95

Analysis of ancient pottery with Raman and (ultra) mobile X-ray Fluorescence instruments: Tracing the technology of pottery from Qalhât (Sultanate of Oman)

Gülsu Simsek - *Labex MiChem - University Pierre et Marie Curie, Paris*

Introduction

A multidisciplinary collaboration between the Qalhât Project (CNRS UMR8167, Orient & Mediterranean) and the LADIR (CNRS UMR7075, Laboratory of Dynamics, Interactions and Reactivity) was elaborated in 2012 in the frame of the Sorbonne University Labex MiChem Project (Multi-Scale Integrative Chemistry : from single molecule to nano-edifices). Thanks to this project, a one year post-doc was obtained to realize physico-chemical analysis on the ceramics excavated at Qalhât, both local and imported. The study aimed, first, at defining the technical characteristics of the pottery produced in the ceramic kilns excavated in 2008 and 2011 in area B41 of the site, to bring light to the technics in use at Qalhât during the mediaeval period, and to differentiate the local productions from imports. And, second, at analyzing several specific imported wares to get information as to their exact provenance. The first objective is still currently under study and will be presented to the Seminar for Arabian Studies in London at the end of July 2013 and then published in the PSAS (see preliminary report down). The second is also still under study for some wares (Bahla Ware, Blue speckled ware) but was completed as far as the Vietnamese porcelain is concerned (see next file).

The Qalhât ceramics

The micro structure of ceramics as well as nanostructure of glazes reveals their technological procedure. Since different technical solutions, as a function of raw materials and expertise, can lead to the similar visual aspects and features, the study of artifacts allows the identification of specific markers characteristic for a period or a place of production. The recent development in optical techniques of analysis, their modeling/simulations and miniaturization offer non-destructive, portable/mobile tools that can be used to select the most representative objects in an archaeological site.

The motivation for this work was to differentiate local productions from the importing ones for a better knowledge of trade networks in Indian Ocean. To this end, rejection shreds of furnace, shards excavated from houses, blue speckled ware, monochromed revetment tiles excavated from the Mosque have been studied using portable, non-invasive X-ray fluorescence (XRF) and laboratory type Raman spectroscopy. Objects were selected that displayed not only a variety of surface finishes e.g. glazed, unglazed, engobed or engraved; but also different pastes colored from reddish to beige containing ungrinded coarse grains or grinded. Some of the samples were transported to the laboratory environment for Raman analyses.

Elemental qualitative measurements were carried out on-site non-invasively with an XRF spectrometer of Brüker Tracer IV system equipped a rhodium (Rh) target X-ray tube that was operated at 40 kV, 10.70 μ A for detecting low z elements (Si, K, Ca, Fe, Ti) and 15 kV, 55 μ A for trace elements (Rb, Sr, Zr) of the body, glaze and pigment-rich area. Measurements are made on un-glazed spots (bottom, section or fracture) or over/on the colored/un-colored glaze. Acquisition time for each spectrum was 180 seconds, typically. The analyzed surface, a few tenths mm² guarantees a representative value for studies on the glaze due to the good homogeneity of the structure. But, the heterogeneity of the body requires several measurements taken from different points of the body for the results being representative. The depth of analysis varies between 27 (Si) and ~385 μ m (Zr).

In addition to the XRF measurements, laboratory type Raman spectrometers were used for the characterization of body, glaze and pigments with the aim of identifying mineral phases and composition of the glaze. Raman spectra were recorded using two instruments: (1) a Senterra Bruker Optics microspectrometer with green (532 nm, 20 mW) and red (785 nm, 100 mW) laser lines; (2) a HR800 Horiba Jobin Yvon microspectrometer with 514 nm laser line (green) of an air cooled Ar⁺ laser source. Both instruments are notch filtered and equipped with a Peltier cooled CCD matrix. Recording times were ~20-200 s, typically.

In order to discriminate between local productions from out of site ones, the major (Ca, K), minor (Fe, Ti) and trace (Sr, Rb, Zr) elements found in raw materials are considered. The count of XRF data of each element is normalized by Si which is considered as a main component of a ceramic body, for eliminating all possible errors resulting from measurement and data treatment procedure. The relationship between Fe and Ti, Ca and K, Rb and Sr, Sr and Zr are shown in Figures 1-4.

From the comparison of Ti and Fe (Figure 1), it is clearly seen that the raw materials used on the paste of blue speckled ware, revetment tiles of the mosque, shards coming from excavated houses are similar to the composition of shards coming from rejection materials of the furnace. Turquoise, blue and green tiles of the mosque show a good cluster as a subgroup of rejection shreds of furnace. So, it can be assumed that they are produced on local site. The distribution of most data along a straight line is consistent with the use of same raw materials where Ti and Fe are both present, but except Type B2 showing a deviation from the linear variation.

The distribution of K and Ca (Figure 2) represents the variation of fluxes related to the production technology. Calcium distribution of Qalhat samples on body is narrower than the potassium distribution. Some of shreds show a little bit higher amount of calcium but the sample of Type B2 exhibits very high Ca content which differs from local productions.

Figure 3 and 4 show the relationship of trace elements (Zr, Sr and Rb). Zirconium element is generally present in sand as zircon and

consequently the zirconium content can be considered as a marker of the used sand. As always the mosque tiles fall in the group of local production, it can be assumed that they were produced in Qalhat. Rubidium and Strontium is clustered along a straight line for most of the shreds except Type B2.

Figure 5 compares representative Raman signatures measured on the glaze of different groups of pottery shards. Spectra show narrow peaks, which are characteristics of crystalline second phase and of pigments. The stretching SiO_4 band at $\sim 900\text{-}1090\text{ cm}^{-1}$ is commonly decomposed in 5 components relative to the five different types of SiO_4 tetrahedron, isolated (noted Q_0), sharing 1 (Q_1), 2 (Q_2), 3 (Q_3), or 4 (Q_4) oxygen atoms with adjacent tetrahedron (Colomban, 2003; Colomban and Paulsen, 2005; McMillan, 1984). The relative ratio of the area of the SiO_4 tetrahedron bending peak (at ca. $500\text{-}550\text{ cm}^{-1}$) and the stretching peak is directly related to the polymerization degree and called index of polymerization (I_p). The large depolymerisation of the SiO_4 glassy network induced by lead addition led to a high intensity of the Q_1 component at $\sim 935\text{ cm}^{-1}$. On the contrary alkali-rich glaze Raman signature shows a $\sim 980\text{-}1090\text{ cm}^{-1}$ feature, the shape varying with composition (Colomban et al, 2006), typical of the kiln production (Liem et al., 2002). In this case, an alkali type glaze was applied on the surface of all these productions (local, blue speckled ware, tiles from the mosque) and the composition is rich in calcium and magnesium which shows a high glazing temperature applied. The presence of cassiterite on the turquoise glaze affirms the technology of glazes with tin oxide particles used by Qalhati potters.

References

- Colomban, Ph., 2003. Polymerization Degree and Raman Identification of Ancient Glasses used for Jewellery, Ceramics Enamels and Mosaics, *Journal of Non-Crystalline Solids*, 323, 180-187.
- Colomban, Ph., Paulsen, O. 2005. Non-Destructive Determination of the Structure and Composition of Glazes, *Journal of The American Ceramic Society*, 88, 390-395.
- Colomban, Ph., Tournié, A., Bellot-Gurlet, L. 2006. Raman Identification of glassy silicates used in ceramics, glass and jewellery: a tentative differentiation guide, *Journal of Raman Spectroscopy*, 37, 841-852.
- Liem, N.Q., Thanh, N.T., Colomban, Ph., 2002a. Reliability of Raman micro-spectroscopy in analysing ancient ceramics: the case of ancient Vietnamese porcelain and celadon glazes, *Journal of Raman Spectroscopy* 33, 287-294.
- McMillan, P., 1984. Structural studies of silicate glasses and melts -- applications and limitations of Raman spectroscopy, *American Mineralogist*, 69, 622-644.

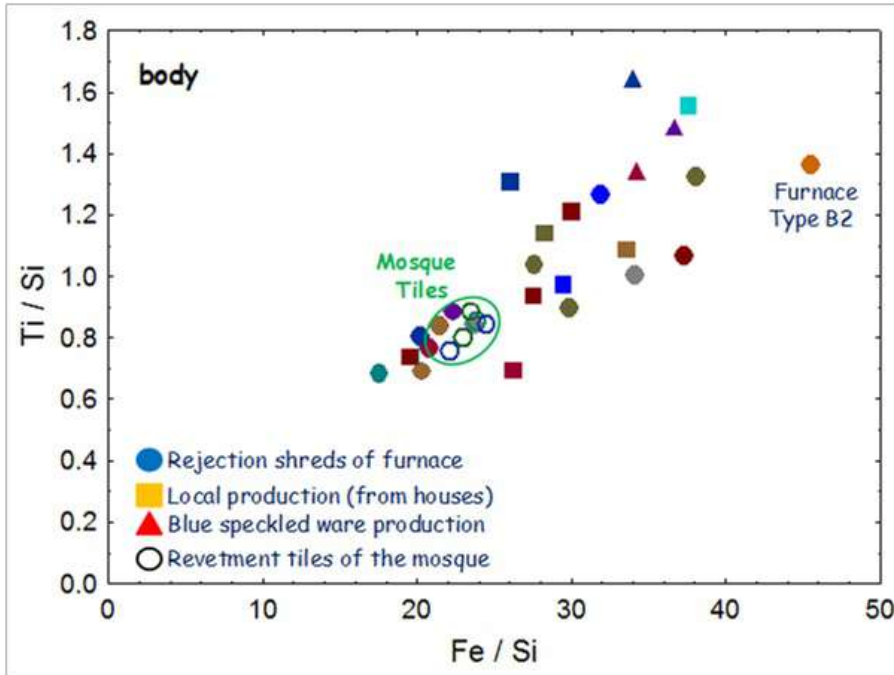

Figure 1. Scattergram of Ti/Si versus Fe/Si ratio.

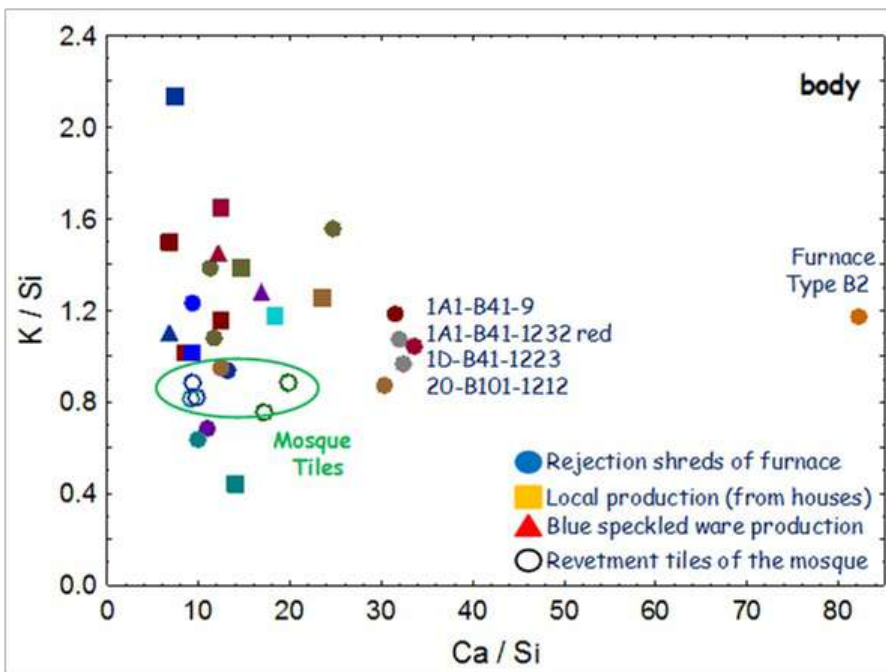

Figure 2. Scattergram of K/Si versus Ca/Si ratio.

Figure 3. Scattergram of Rb/Si versus Sr/Si ratio.

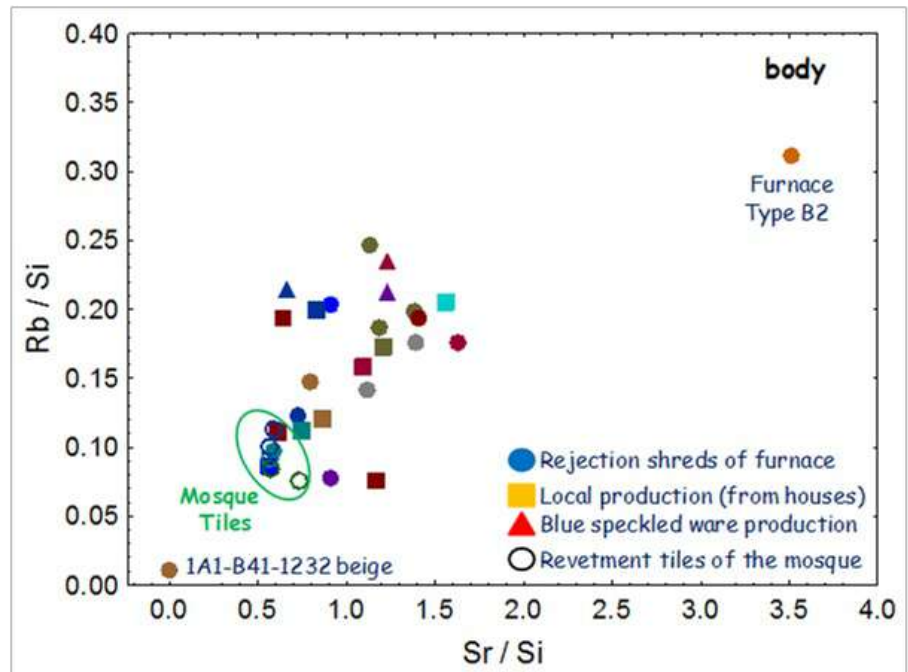
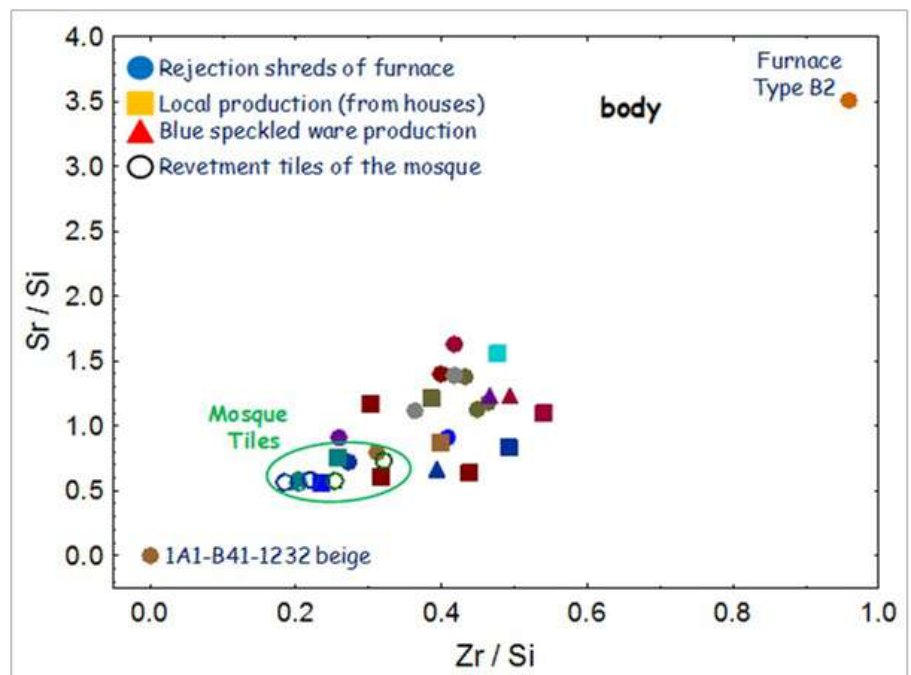

Figure 4. Scattergram of Sr/Si versus Zr/Si ratio.



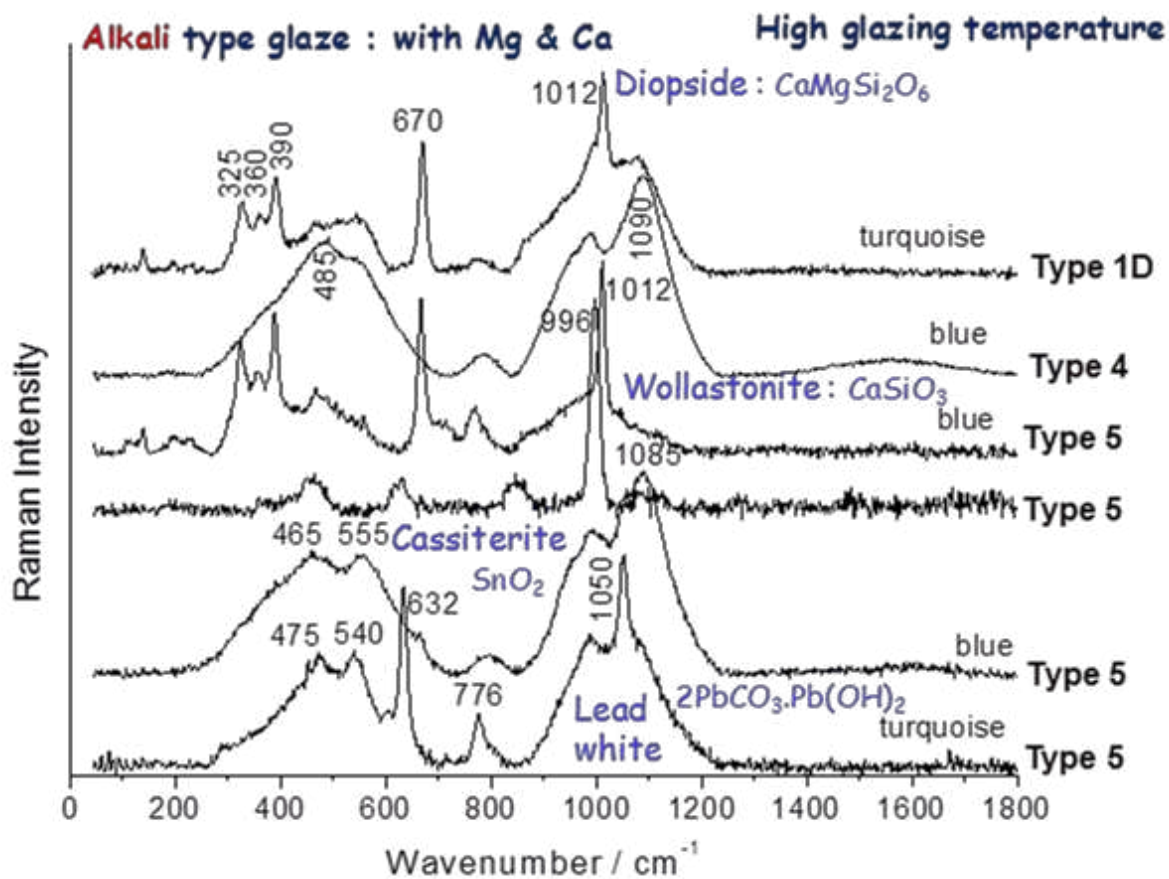

Figure 5. Representative Raman spectra recorded on the glaze of monochromed shards. Type 1D: Rejection shreds of local furnace, Type 4: Blue speckled ware samples, Type 5: Monochromed tiles of the mosque.

The identification of Vietnamese and Chinese ceramic shards from Qalh t with portable X-ray fluorescence and Raman spectroscopy

Gülsü Simsek^{a,b}, Philippe Colomban^a, Stéphanie Wong^a, Bing Zhao^c, Axelle Rougeulle^d,
Nguyen Quang Liem^e

a : MiChem Labex, Sorbonne, University Pierre et Marie Curie (UPMC), Paris ; b : Ladir, CNRS UMR 7075, University Pierre et Marie Curie (UPMC), Paris ; c : CRCAO, UMR 8155 - CNRS, Paris ; d : CNRS - UMR 8167, Paris ; e : Institute of Materials Science, VAST, Hanoi.

1. Introduction

1.1. Historical and methodological background

Chinese porcelains have been exported by land (Silk Road) and maritime trade routes during medieval period.¹⁻⁵ In terms of global history, as early as the 1st century CE a series of long-distance maritime networks emerged, based on the seasonal shifting of the monsoon winds. Their development led to the progressive integration of different regions of the Indian Ocean. From the 7th century onward, specifically because of the parallel expansions of the Chinese empire of the Tang dynasty (618-907) and of the world of Islam, the Indian Ocean and China Sea were interconnected and formed the first cross-continental global systems.⁶⁻⁸ It was through this very Afro-Asian maritime global network that a regular westward trade by sea of oriental ceramics seems to have started around the 9th century.^{9,10} Thanks to considerable efforts of archaeologists since these last decades, a very large quantity of Chinese and South-East Asian ceramic shards have been yielded and collected from archaeological sites located both in costal and offshore regions of the western Indian Ocean and its subordinate seas. Due to their durable nature, a wealth of examples of ceramic shards survived in archaeological sites offer some very promising historical and anthropological information for studies both of global mercantile networks and of local and regional material cultures. Methodologically speaking, “style” approach – in terms of objects’ shape, form and decoration - has been generally used to assign dating and origin, while technical studies on these archaeological data have been most occasionally conducted.^{11,12}

In spite of its limits, stylistic analysis has revealed the multi-national nature of the oriental ceramics trade across the Indian Ocean. Regarding to Vietnamese ceramics imported into the western Indian Ocean, shards of green-glazed stoneware found from the layer dated to the end of the 8th or the beginning of the 9th century - layer located under the foundation of the first mosque - on the port site of Siraf might originate from the Hong River bank region in Northern Viet

Nam.¹³ Nevertheless, scholars agree that it is only from the latter half of the 14th century that Vietnamese ware might be introduced into regular long-distance trade through the Indian Ocean because of a scarcity of Chinese wares from the 14th century; these imports will be maintained until the first decade of the 16th century, as an attest evidence from numerous port and shipwreck sites.¹⁴⁻¹⁶ As well for other archaeological artefacts, studies related to the diffusion of Vietnamese wares are made until now exclusively by using stylistic and visual technical criteria.¹⁴⁻²³

Strictly speaking, identification of the origin of a shard is possible only when the shard in question can be matched with evidence from a production site. Fortunately, kiln site archaeology in China has developed considerably since the 1990s onwards. Several hundred kiln sites have been discovered or surveyed all over the country, and many important excavations have been undertaken on the sites that produced ceramics for overseas trade. The traditional insight of Chinese ceramic trade based on main kiln sites, such as Jingdezhen and Longquan kiln complexes, is most notably challenged by these new data. For instance, in relation with Vietnamese productions, numerous kiln sites in Southern China have provided shards bearing usual features that are observed previously only on Vietnamese ware. For example, blue-and-white ware with a chocolate base is revealed from Yuxi or Jianshui kiln sites in the Yunnan Province²⁴⁻²⁶ that look similar to the products produced in Chu Đậu, Vietnam during the 14-15th century.²⁷⁻³⁰ Furthermore, samples in green-glazed stoneware with firing-scars and/or sharing stylistic parallels with South-East Asian productions have been excavated or collected from a large number of sites located in the Fujian, Hunan, Guangxi, Guangdong and Yunnan Provinces.³¹ Traditional style approach having been thus challenged by these new data, a cross-study of style and technology should be tested in order to find a new and promising scope to assign the origin more confidently.

Compositional analysis and technical insight in the body microstructure and glaze nanostructure are time and sample consuming. Although Chinese porcelains have been extensively studied by a variety of archaeometric and ceramic methods since long-time.³²⁻⁵² However, these studies have been conducted at the laboratory using heavy instruments (see above references) and many measurements require a preparation of the sample. The availability of portable XRF instruments makes possible the non-invasive, fast analysis of the body, glaze and pigment-rich area of many samples, offering a more representative view of the technology. But however, a large debate is carried out in the abundant literature.⁵³⁻⁶⁰ Some groups are searching to establish the accurate composition of a very limited number of selected samples using fixed instruments. Such approach does not reflect the intrinsic dispersion of artifact productions in one place at one time because of the intrinsic dispersion of the raw material composition. And the others are trying to determine qualitative sourcing criteria using data obtained from the non-destructive portable

XRF (pXRF). This technique allows studying a large number of samples that give some statistic view of the production variability. Previous studies^{55,56,58,59} demonstrated that pXRF was a both primary and complementary method in qualitative and semi-quantitative analysis of porcelain, stones and other ceramic materials. In order to evaluate the potential of this instrument prior to the action of on-site analysis campaigns, the selected series of shards in monocolour glazed stoneware, in blue-and-white ware, and underglazed brown-painting stoneware assigned to the Vietnamese and southern Chinese productions have been respectively compared with representative shards collected from kilns sites in Vietnam (for instance those from the Chu Dâu, My Xa & Ha Lan kilns sites, Hong River bank region; Ngu Hanh Son, Da Nang, Central Việt Nam), as well as with those from the Cù Lao Chàm shipwreck cargo. The later groups of samples have been previously studied by different techniques.^{27,29,30,61-63} Modern samples of different origin as well as ancient Chinese porcelains with good pedigree were also considered in order to select the most pertinent parameters. Major, minor and traces element contents, characteristic of raw materials (sand, kaolin/clays, feldspar) and/or production process (Fe) as well as colouring ores will be discussed. The comparison of the microstructure and of the Raman fingerprint of the different glazes will be used to ascertain the artifact to Vietnamese kilns or not. Obviously the information on elemental composition given by mobile XRF measurements remain qualitative and do not have the same reliability of measurements performed on sample prepared for the analysis and studied with bigger instruments and adapted procedures. In order to assess the identification on technological criteria the composition parameters will be selected and discussed with respect to the raw material compositions and we will limit the use of chemometrics.

1.2. The port site of Qalhāt

Qalhāt (22° 41' 40" N; 59° 22' 30" E) is one of the most impressive archaeological sites of Oman, with a huge area of ruins of about 35 ha. It is located on the coast of al-Sharqiyyah province, 20 km north of the city of Sūr. According to literary sources, the port, created around the 11/12th centuries, was the twin city of Hormūz during the 13th to 15th centuries. Hormūz ports are mentioned in old Chinese sea-route maps, e.g. the so-called *Zheng He hanghai tu*.⁵ It was supplanted by Muscat as the chief port of Oman in the 15th century and was probably devastated by an earthquake at the end of the century. However, it was still one of the main coastal cities of Oman when the Portuguese sacked it in 1508. It subsequently became a station for the Portuguese fleet and was then permanently abandoned in the second half of the sixteenth century.^{64,65} The Qalhāt Project started since 2008 is under the authority of the Ministry of Heritage and Culture of the sultanate of Oman and the French archaeological Committee of the Ministry of

Foreign Affairs and the National Centre for Scientific Research (CNRS-UMR 8167). The objectives of the Qalhāt Project are manifold. First, to provide information on the history of Qalhāt itself, its foundation, rise and decline, and on the local economy, exchange networks of the harbour, and the part it played in the Indian Ocean trade, especially during the Hormūzī period which is still poorly documented. Secondly, to provide information on the layout of a medieval Omani city, as Qalhāt is a rare example of an ancient settlement completely preserved under its ruins. Although virtually nothing is visible on the surface, the plan of the city appears quite clearly on aerial views, and it may be possible to reconstruct it rather precisely. Finally, the project must also provide a scientific basis for the development of the site.^{64,65} Surveys and excavations between 2008 and 2011 have provided a corpus of some 2000 shards of Chinese and South-East Asian ceramics. Among the 45 selected samples, a series of analysis are conducted on 13 shards. Our purpose is to develop procedures to be used at the excavation places. Port cities of the Indian Ocean offer pottery and glass remains contributing to better knowledge on the ancient Monsoon trade roads between South-east Asia, China, India, Africa and Arabian/Persian Gulf and Mediterranean World.

2. Experimental

2.1. Samples

Fig. 1 shows the 13 selected shards excavated from Qalhāt: the first group is made of monocolour-overglazed samples rather similar to Vietnamese green-glazed and ivory-creamy-glazed stoneware of Tran dynasty.^{15,22} The second group (3 samples, Table 1) is recognized as underglaze iron-brown painting stoneware and the last one consists of 7 bleu-and-white ware shards. Actually a light blue décor is slightly present under the monocolour glaze of BW7 sample. Reference samples (Table 1) have been chosen among shards excavated from kiln sites close to Hong River, Hai Duong Province, previously studied by XRD, EDS and Raman scattering.^{61-63,29} Additional samples have been excavated from Ngu Hanh Son, Da Nang Province, Central Viêt Nam. Samples from the Cù Lao Chàm shipwreck cargo (close to Hôi An, Central Viêt Nam) previously studied by various techniques are also selected. Three shards of Chinese blue-and-white porcelain, one from a vase of Qianlong period (r.1736-1796), a shard from the Abrantès Palace, French Embassy in Lisbon (end of 17th century) and a shard from Surcouf' shipwreck cargo (17th century). We put also in the group series of 20th century productions, collected in Hoa Lu (Ninh Binh) twenty years ago, North Viêt Nam; they were added in order to enlarge the palette of the composition/technology and to permit the identification of parameters specific to Vietnamese production of the medieval/post medieval times particularly for the evaluation of on-site measurements.

Selected shards have been sliced with a low-speed Struers Microtom™ diamond saw in order to have 2-5 mm thick wafer with two parallel faces allowing a good examination with an optical Olympus microscope and collection of Raman spectra on the different microstructure layers and the measurement of slip/glaze thickness (Table 2). No polishing is conducted in order to keep procedures compatible with on-site campaigns.

2.2. XRF measurements

Elemental qualitative measurements were carried out non-invasively with an XRF spectrometer positioning the Brüker Tracer III-SD instrument in contact with the samples. The instrument is equipped with a rhodium (Rh) target x-ray tube that was operated at 40kV, 10.70 μ A (trace elements analysis) and 15kV, 55 μ A (low z major elements), with 13 μ of Be detector window and without addition of filter respectively. Measurements are made on un-glazed spots (bottom, section or fracture) or over/on the coloured/un-coloured glaze. Acquisition time for each spectrum was 180 seconds, typically. The analysed surface, a few tenths mm² guarantees a representative value for studies on the glaze and porcelain/stoneware bodies because of their good homogeneity. However, the nature of the XRF technique is such that elements constituting the ceramic wares are excited in a so called “interaction volume” which can be several microns or even mm thick, depending on the composition of the matrix. Layers on top of them can absorb fluorescence signals emitted by buried layers.⁶⁰ This is an important problem for the analysis of glaze and décor: the presence of heavy element limits the penetration depth and the contamination with the body contribution. Therefore interpretation of the spectra can sometimes be complicated but do not affect significantly the measurement made on the body. Representative spectra recorded at low and high excitation energy are shown in Fig. 2. Elements from Al to Zr are measured at 15 and 40 kV. The depth of analysis is a function of the photon that each element emits when it is excited. Only qualitative analysis can be performed for determining elemental presence. The depth of analysis varies between 17 (Al) and ~385 μ m (Zr). The K-linepeak for each element except Pb, which is recorded at L line, are labelled and used for the comparison of the composition ratio. It should be noted that beside K-line, a sum peak can be observed at the point of the sum of the K- α peak and the K- β peak but much smaller, when any element has very large concentration, i.e. high concentration of Fe in ceramics.

2.3. XRF data processing

For fitting the XRF spectra, a data treatment method was created for each voltage, in this study 15kV and 40kV. The resolution parameter defined by FWHM value which represents the width of the Fe peak in

eV half way up, is considered prior to the spectrum treatment. The resolution of the XRF spectrometer used in this study is 150 eV at 6.4 keV. The background was corrected between 0.8-20 keV for 15kV and 0.8-30 keV for 40 kV with 10 cycles of iteration with the Artax (Bruker) software. Then, the net area under each peak was calculated at the characteristic energy of each element.

Binary scatter diagrams are plotted with Statistica 10[©] (StatSoft, Inc.) software for comparison of major (Al, Si, K, Ca), minor (Fe, Ti) and trace elements (Zr, Rb, Sr, rare-earths, etc.) related to the raw materials used on the body and fluxes characteristic of the production technology. The count of XRF data of each element is normalized by Si, which is found in bodies of all samples as a main component, for eliminating probable errors resulting from measurement and treatment procedure.

Additionally, in order to discriminate between groups of ceramic shards excavated from the port site of Qalhāt depending on the variation of body composition, a cluster analysis is performed using Statistica 10[©] software, as reported in previous works.⁶⁶ This is a simple and complementary method for the validation of the results from bi-plot studies. The trace elements, e.g. zirconium, rubidium and strontium, are considered as primary indicators in comparing different types of glazes and bodies.

2.4. Raman microscopy

Raman measurements were made in different spots using different instruments:

1) The Senterra Bruker Optics instrument (Ettlingen, Germany) using a 532 nm YAG laser or a 785 nm diode laser source equipped with a Peltier-based cooled charge-coupled device (CCD) detector. The power was typically ~20 (green laser) and 200 (red diode) mW at the sample. This instrument has a good sensitivity and can be moved. As all Notch filtered spectrometers, the background is complex (archaeological samples exhibit strong fluorescence due to residues of the biological film formed at the sample/pore surface) and a baseline subtraction is mandatory, that induces some subjectivity in the Raman parameter determination.⁶⁷ The recorded spectra are thus rather comparable to those obtained with a mobile Raman set-up.^{67,68}

2) The XY Dilor spectrometer using the 407 nm line of a Kr⁺ (Coherent) laser and equipped with a liquid nitrogen cooled CCD detector. The power was typically 2 mW at the sample. The violet illumination burnt the fluorescence promoting biological film. The Rayleigh filtering is achieved using grating (1) and Notch (2) filters.

All the spectrometers are coupled to an Olympus microscope; sample observation and analysis are performed using Olympus long working distance objectives of x20 and x50 equipped. The Raman parameters are then processed according to the methods previously established

(SiO₄ components, polymerization index) in order to discuss the production technology.^{28,69,70}

3. Microstructure analysis

In order to highlight the difference between Vietnamese and Chinese production, sliced sections of very typical 15th century blue-and-white ware shards from Chu Dâu kiln and the 17th and 18th century Chinese blue-and-white ware shards from Jingdezhen kiln site are presented in Fig. 3 and Fig. 4, respectively. Fig. 3 shows four sections of blue-and-white ware shards from Chu Dâu kilns: the grey colour of the porcelain body is obvious as well as the darker hue of the blue décor, according to the high manganese and iron content of the used cobalt ore.^{29,63,71} Two other characteristics are observed: i) a white interface, more or less well-defined in between the body and glaze, ii) the blue design is generally put over the glaze, not under the glaze.^{29,62} The elongated pores are consistent with a wheeled production using a medium plasticity paste. Fig. 4 shows the vivid blue design at the interface between the body and the glaze. This white porcelain body is characteristic of Qing Dynasty Jingdezhen productions displaying a dense, fine-grained structure.

Fig. 5 compares two multicolour shards, so-called *tam thai* in Vietnamese (sam cai equivalent Chinese spelling), one from My Xa kiln (Hong River bank) and one from the Cù Lao Chàm cargo (here after noted CLC). The My Xa samples show green dots and a red line décor depicting palmettos, strongly degraded. The degradation of the décor is more drastic in fragments of the shipwreck cargo: only the gloss loss under a given angle of examination allows detecting the trace of the red décor in CLC sample, in the form of peacock feather. The blue overglaze lines are well preserved. The grey body is very similar to those of Chu Dâu production, as expected. A white interphase is visible in between the glaze and the body.

Fig. 6 and 7 show sections of Qalhāt underglaze iron-brown stoneware (IB3) and blue-and-white ware samples (BW1, BW2, BW4). The body colour and porosity look very similar to the above Vietnamese wares. Some samples exhibit many characteristics of the glazed Vietnamese production: white interphase, blue overglaze decor (Table 1). Note the brown décor is clearly located under the glaze (Fig. 6a) and a blue underglaze depict is visible for BW7 sample (Fig. 1). The thicknesses of the interface/slip and glaze layers are given in Table 2.

4. Major/minor elements and traces analysis

Table 3 gives the typical composition of the body and various glaze/enamel of a *tam thai kirande* piece from Cù Lao Chàm shipwreck cargo previously determined by combination of techniques.^{29,63,72} The composition is very close to that measured on other production places close to Hong River.⁷³ The potassium-based

body composition is consistent with the mullite-based porcelain prepared from kaolin and feldspar. The alumina content is however a little lower than in Chinese productions.^{34,52} The glaze composition contains potassium, sodium and calcium, the latter flux element being dominant. As previously pointed out, this is the very characteristic of Vietnamese productions vs. contemporary Chinese ones. Ancient Chinese proto-porcelain glazes contain a high level of calcium and this was related to the use of ash as lime source.^{34,47} Similar calcium-rich compositions remain largely used for centuries in all the China.⁴⁸ Red décor is made with hematite and green décor coloured with copper. A large lead addition was made to allow a *Petit feu-technique* glazing. The silica content is higher in the interphase, according to a deposit of sand-rich powder prior the glaze or a special preparation (washing?) eliminating most of the clay particles; the small CaO amount detected in the slip should result from diffusion of the Ca-rich molten glaze. Pb-traces in red enamel can result from addition or contamination during the supplementary firing of the green lead-based overglaze.

4.1. Body and glaze analyses

We now discuss the body and glaze analysis results in order to discriminate between Hong River bank kiln productions from other ones, thus we would first consider the major elements of the body. Fig. 8 shows the relationship between Al XRF-peak intensity vs. logarithmic value of the K peak intensity. Data are roughly found along a straight line according to the use of materials with similar Al/K ratio, for instance for the ferruginous and white kaolin-like materials collected during the excavation of the kiln site. However, highlighting specific differences can make grouping: Bat trang and My Xa potteries exhibit lower K and Al levels. On the other hand high values are observed for China, Korean and Japanese reference samples. Actually, two Chinese shards from Surcouf' shipwreck (BW-Ch1, BW-Ch2) are however determined in the main group with Việt Nam samples. The scattering of the data is large but remains almost comprised between the values measured for the Chu Dâu 'kaolin'. Two Qalhāt samples, BW5 and C3 are located at the periphery of the main distribution.

The comparison of the Ti and Si content (Fig. 9) identify very well the different Vietnamese productions under study: 2 main groups, Việt-1, corresponding to the kilns of the Hong River bank region and Việt-2 from Central Vietnam. A third group, with lower Ti content assembles the Chinese productions and four samples from Qalhāt: BW4, BW5, BW2 & BW6. Note the straight line joining the data of kaolin and ferruginous clay collected at Chu Dâu. Higher titanium content is measured for Vietnamese pottery, indicating that part of titanium arise from the sand and not only from the kaolin/clay. The low titanium (and iron) content of Chinese productions has been assigned to a careful purification of their raw clays/kaolin, through levigation by Chinese Song potters.^{39,40} Fe/Ti oxides can have very high concentration of

transition metals (V, Cr, Ni) and of elements such as Nb, Ta. Levigation, a gravitational process, eliminates heavy minerals with their impurities.

The above classification of the body composition is confirmed by considering the Rb vs. Sr relationship (Fig. 10): Chinese references exhibit higher Rb traces and lower Sr content; on the contrary high Sr level is detected in ancient My Xa, Central Viêt Nam and modern Bat trang shards. Qalhāt BW5, BW4 and for some extent BW2 samples are located close to Chinese production fingerprint, far away from those of Vietnamese potteries. Although clays are secondary/sedimentary matter that had been degraded and transported far away from the pristine rock, identification from impurities content is less reliable, differences appear significant. This criterion was recognized as relevant marker for the identification between different Chinese green-glazed stoneware.⁴⁸ Data measured for Chu Dâu production and for samples belonging to the Cù Lao Chàm cargo are very close according the same expected provenance of the sea-excavated artefacts.²¹

Fig. 11 compares the Zirconium content measured on the body (Fig. 11a) and glaze (Fig. 11b). Zirconium is expected coming from zircon crystals, a common second phase in many sands, already detected in Chu Dâu productions.⁶³ Zircon has usually high content of Hf, Y and Rare Earths. Chinese glaze and body as well as modern Japanese porcelain exhibit lower levels of zirconium. Highest content is measured for the glaze of shards from Central Vietnam. A very large level of zirconium is measured in modern Bat Trang porcelain body. Qalhāt BW4, BW5 and BW6 samples are also located along with Chinese shards on zirconium distribution on the body and glaze.

The Ca vs. K relationship of Fig. 12 also classifies Vietnamese glazes from other productions: high Ca and low K content to be compared to the high K content of Chinese glazes, according Wood³⁴ and our previous study.⁶³ The grouping of Chu Dâu and Cù Lao Chàm artefacts is good. Qalhāt BW4 and BW5 samples exhibit higher K content discriminating from Vietnamese production, mostly adducting to Chinese shards. However, regarding the corpus from Qalhāt, shards in monocolour-glazed stoneware and in underglaze iron-brown painting stoneware show higher Ca than those in blue-and-white ware of Qalhāt. Moreover, the variation of K is more or less similar for all Qalhāt groups except for BW4 and BW5.

5. Colouring agents and glazes

Fig. 13 compares the scattergrams Co vs. Mn (Fig. 13a) and Ni vs. Co (Fig. 13b), normalised with respect to Si peak. Measurements have been made as closest as possible of the blue or green décor but obviously contribution of the glaze matrix cannot be excluded. In order to take into account the error due to the variable glaze thickness the Co, Fe and Mn peak intensity are plotted after data to be divided by the thickness. Fe and Mn content are nil or very low for the two modern

blue-and-white porcelains (BW-JP1 and BW-Hu2), according to the purification of the cobalt source. On the contrary, measurement on Chu Dâu and Cù Lao Chàm blue décor exhibit high manganese content, as previously established.^{29,63,73} Intermediate features are observed for ancient Chinese blue-and-white ware shards. Significant manganese contents have been already observed in some Chinese productions.³⁵ However, most of the cobalt ores in Yunnan and North Vietnam are manganese-rich minerals.⁷¹ Minor elements associated to cobalt one have been considered as good markers of the cobalt ore origin^{74,75} although the mining places have been rarely located.⁷¹ Although manganese is associated to many Chinese blue decoration of Yuan/Ming Dynasty, BW5 artefact does not belong to the same group than Hong River bank Vietnamese productions, because the décor is coloured only of black pigment. However, the black décor of BW3 contains similar Co amount with Vietnamese ceramics.

A high level of Ni trace is measured for the green enamel (Fig. 13b) and should be an impurity of copper, the green colouring agent. The correlation between Ni and Co-content is also clear. Significant Arsenic traces are measured for green enamels (Fig. S1, Supplementary Materials). In order to better compare the Co, Fe and Mn content, the respective XRF peak intensity has been normalized with the glaze thickness (Fig. S2). Higher Mn content is measured for shards from Vietnamese kiln sites and for two Chinese samples of Qianlong period and from the Abrantès Palace.

Fig. 14 and Fig. S3 show a hierarchical clustering analysis retrieved from the data collected on the body and glaze of Qalhāt shards including reference samples. This method allows separating main and sub-groups depending on the variation of trace elements of zirconium, rubidium and strontium (Fig 14a & Fig. 14b). The attribution was not strictly defined but grouping similar Qalhāt shards closer in composition to the specific productions of Chinese or Hong River bank kiln developed a criterion. The earliest shard of brown-ivory décor type (BI-Ly) and modern production of Bat Trang (C-BT1) appear relatively on the right and left end of the dendrogram showing the change on the composition throughout centuries and also production centres. The Zirconium content of the newer shard is double of the older as well as Rubidium is very low. The plot of BW5 and BW4 shards data including BW6 on the border of Vietnamese ceramics are always out of Qalhāt group and they are consistently situated in the group of Chinese productions (see Fig. 15). The discrimination of Central Viet Nam ceramics is mostly made by comparing the glaze data rather than the body which shows an inhomogeneous structure misleading about the interpretation of measurements. Thus, the differentiation of ceramics made in Central Viet Nam and Hong River can be recognized obviously.

Fig. 15 compares representative Raman signatures measured on the glaze and décor of Qalhāt shards. Wavenumbers of the reference peaks are listed in Table 4 and some examples of as-recorded Raman spectra

are shown in Fig. S4 as well as the corresponding spectra obtained after baseline subtraction.^{67,76} Spectra show narrow peaks, which are characteristics of crystalline second phase and of pigments. Many spectra exhibit the signature of undissolved α -quartz (main peaks at 462 and 200 cm^{-1}). The $\sim 2 \text{ cm}^{-1}$ downshift of the 464 cm^{-1} SiO_4 bending modes arise from the tensile stress due to the lower thermal expansion of crystalline mullite and glassy mullite-like matrix.^{77,78} Note, the Raman spectrum of the inter-phase corresponds to almost pure quartz. Rutile TiO_2 Raman signature ($\sim 448\text{-}612 \text{ cm}^{-1}$ strong doublet) is often detected in body, as usual according to the high titanium content of Vietnamese production (Fig. 9).^{28,61} Cristobalite ($\sim 227\text{-}413 \text{ cm}^{-1}$ doublet) detected in some body (e.g. BW2 spectrum) is characteristic of secondary silica formed by dissolution and transformation of primary quartz grain during high temperature firing.^{79,80} Wollastonite (970 & 637 cm^{-1} narrow peaks), a phase typical of calcium-saturated glaze, is often detected.

The stretching SiO_4 band at $\sim 900\text{-}1050 \text{ cm}^{-1}$ is commonly decomposed in 5 components relative to the five different types of SiO_4 tetrahedron, isolated (noted Q_0), sharing 1 (Q_1), 2 (Q_2), 3 (Q_3), or 4 (Q_4) oxygen atoms with adjacent tetrahedron.^{28,69,70,81} The relative ratio of the area of the SiO_4 tetrahedron bending peak (at ca. 500-550 cm^{-1}) and the stretching peak is directly related to the polymerization degree and called index of polymerization (I_p). The large depolymerisation of the SiO_4 glassy network induced by lead addition led to a high intensity of the Q_1 component at $\sim 935 \text{ cm}^{-1}$. On the contrary alkali-rich glaze Raman signature shows a $\sim 950\text{-}1050 \text{ cm}^{-1}$ feature, the shape varying with composition,⁷⁰ typical of the kiln production.⁶² For instance the Raman fingerprints of monocolour glazed stoneware (C1-C3) and underglaze iron-brown painting stoneware (IB1-IB3) are very similar.

Main Raman parameters of glazes are listed in Table 5 which shows two different groups. The strong fluorescence background measured under green laser excitation for archaeological samples because formation of a biological film at the sample porosity surface involves a baseline subtraction. This subtraction induces some error in the determination of the I_p value, but the error is rather systematic and allows a comparison of data recorded with the same instrument. The former group is poor in lead with I_p more than 2.2 and the glaze firing temperature is thus above 1000 $^\circ\text{C}$. However, the second group is rich in lead with an I_p less than 1.3 and the firing temperature is around 700-750 $^\circ\text{C}$. Previous study of Liem *et al.*⁶² shows that the stretching parameter (ν) varies from 939 to 958 cm^{-1} and 1024 to 1044 cm^{-1} , respectively for Chu Dâu-My Xa and Ha Lan samples. Qalhāt shards also exhibit a shift from 928 to 976 cm^{-1} and 1015 to 1072 cm^{-1} which shows different technology of samples analyzed. By comparison the I_p value measured for Ming productions lie between 1.4 and 2.51

Raman measurements of black décor (Fig. 15) show the use of a mixture of hematite (222, 290, 405, 500, 1320 cm^{-1}) and magnetite (665 cm^{-1}) and of a manganese oxide rich pigment (645 cm^{-1}). Grey

and white glaze exhibit the presence of calcium phosphate $\text{Ca}_3(\text{PO}_4)_2$ with quartz crystal.

6. Conclusion: assignment of the production place

The combination of XRF and Raman analyses allows classifying the different samples. The very similarity of Hong River bank kiln productions with the artefacts from Cù Lao Chàm shipwreck is obvious. Underglaze iron-brown painting stoneware shards, as well as green-glazed and ivory-creamy glazed stoneware shards from Qalhāt belong to Hong River bank production groups and can be thus recognized as Vietnamese productions. As far as the blue-and-white ware shards, the BW4 and BW5 shards always are measured out of the Vietnamese Hong River bank group, closer to exemplified Chinese productions. The BW2 and BW6 samples have specific behaviour, often located close to the periphery of the Hong River bank kiln data cloud, according the use of rather similar raw materials. However a production different of the Chu Dâu/My Xa complex is likely. The Raman signature of their glaze remains very close to that of Hong River bank production. However the BW4 microstructure shows a blue underglaze décor (Fig. 7c) although overglaze blue is noted for e.g. BW1 and BW2 shards.

The combination of XRF and Raman non-destructive analysis, both techniques being mobile and susceptible to be conducted on-site⁶⁸ shows that at least 2 samples exhibiting a décor very similar to Vietnamese Hong River bank production actually have been made with other raw materials. A comparison with XRF parameters measured on southern Chinese productions (the Fujian and Yunnan provinces will be necessary to go deeper in the discussion.^{26,31,82} However some of the Yunnan production centres are close to the first part of the Hong River and raw materials with similar minor/traces signature are possible. The underglaze blue décor as well as a white, quartz-rich interface masking the grey body appears to be very characteristic of some Vietnamese Hong River bank productions of the 15th-16th century, indicating a specific technology.

Acknowledgments

Hélène Renel is kindly acknowledged in her help for the selection and classification of samples.

References

- [1] Kingery WD, editor. *Ancient Technology to Modern Science, Ceramics and Civilization, Vol. I*. Westerville: The American Ceramic Society Inc.; 1984.
- [2] Kingery WD, editor. *The Development of Chinese white Porcelain. Technology and Style, Ceramics and Civilization, Vol. II*. Westerville: The American Ceramic Society Inc.; 1985.
- [3] Kingery WD, editor. *The Development of Chinese celadon and its*

- influence. High-Technology Ceramics, Ceramics and Civilization, Vol. III.* Westerville: The American Ceramic Society Inc.; 1986.
- [4] Colomban Ph. Routes et échanges de la céramique avant le XVI^e siècle/Roads and ceramic exchanges prior 16th century. In : Colomban Ph, editor. *Taoci*, 4. SFECO Editions Findakly, Suilly-la-Tour; 2005, p.196.
- [5] Schottenhammer A. The "China Seas" in world history: A general outline of the role of Chinese and East Asian maritime space from its origins to c. 1800. *J Marine Island Cult* 2012;**1**,63-86.
- [6] Abu-Lughod J. *Before European Hegemony: The World System a.d. 1250–1350*. New York: Oxford University Press; 1989.
- [7] Frank AG, Gillis BK, editors. *The World System: Five Hundred Years or Five Thousand*. London: Routledge Press; 1993.
- [8] Beaujard Ph. The Indian Ocean in Eurasian and African World-Systems before the Sixteenth Century. *J World Hist* 2005;**16**(4),411–465.
- [9] Pirazzoli-t'Serstevens M. Une denrée recherchée: La céramique chinoise importée dans le golfe arabo-persique, IX^e–XIV^e siècles. *Mirabilia Asiatica : Seltene Waren im Seehandel*, 2005;**2**,69-88.
- [10] Krahl R, Guy J, Raby J, Wilson K, editors. *Shipwrecked: Tang Treasures and Monsoon Winds*. Washington DC; 2011.
- [11] Sasaki T. Technical studies on the ceramics excavated from Julfar in Ras al-Khaimah". *B Archaeol*, The University of Kanazawa, 1994;**21**,107-119.
- [12] Sasaki H, Sasaki T. Scientific analysis of white glazed ware from Julfar. *Proceedings of the Seminar for Arabian Studies* 1998;**28**,247-250.
- [13] Wisniewski B. *La tradition céramique vietnamienne du premier millénaire de notre ère. De l'apparition des fours à haute température à l'émergence d'une production organisée: étude archéologique*. Ph D. Dissertation, Paris 4 La Sorbonne/EPHE; 2012.
- [14] Stevenson J, Guy J. *Vietnamese Ceramics. A Separate Tradition*. Chicago: Art Media Resources; 1997.
- [15] Brown RM. *The Ceramics of South-east Asia: their dating and identification*. Chicago: Art Media Resources, Ltd; 2000.
- [16] Zhao B. Global Trade and Swahili Cosmopolitan Material Culture: Chinese-Style Ceramic Shards from Sanje ya Kati and Songo Mnara (Kilwa, Tanzania). *J World History* 2012;**23**(1) ,41-86.
- [17] Young CM, Dupoizat MF, Lane EW, editors. *Vietnamese Ceramics*. Southeast Asian Ceramic Society, Oxford University Press; 1982.
- [18] Diem AI, Tan RC, Gotuaco L (contributor). *Chinese and Vietnamese Blue-and-White Wares Found in the Philippines*. Philippines: Makati City, Bookmark; 1997.
- [19] Butterfields. *Auction catalogue: Treasures from the Hôi An Hoard, Important Vietnamese Ceramics from a Late 15th / Early 16th Century Cargo*. USA: Butterfields Auctioneers Corp; 2000.
- [20] Tri BM, Nguyen-Long K. *Vietnamese Blue and White Ceramics*.

Hanoi: The Social Sciences Publishing House; 2001.

[21] Tri BM, Tin TT, Liem NQ, Colomban Ph. The Cù Lao Chàm (Hôi An) shipwreck: How to date and identify the ancient Vietnamese porcelains and celadons excavated? *Taoci* (B Soc Française Céramique Orientale), SFECO, 2001;2,105-110.

[22] Colomban Ph. Eessor et Apogée de la Céramique Vietnamiennne. *Revue de la Céramique et du Verre* 2002;125,18-22.

[23] Zhao B. Luxury and Power: The fascination with Chinese Ceramics in Medieval Swahili Material Culture. *Orientalions* 2013,4,71-78.

[24] Yunnan wenwu kaogu yanjiusuo, Yuxi shi Hongta qu wenwu guanlisuo, 玉溪窯綜合勘查報告 . Yuxi yao zonghe kancha baogao (Report en excavations of the Yuxi kiln site). Kaogu; 2001;12, pp. 60-70.

[25] Chen L, Dong X. Jianshui ciyao diaocha yu tantao (Discussions and Survey of the kiln site of Jianshui). *Zhongguo gu taoci yanjiu* 2007;13,87-101.

[26] Shih CF. Yunnan diqu qinghua ciqi de bianqian – jiantan yu Jiangxi Jingdezhen he Yuenan qinghuaci de guanxi (Evolution of bleu-and-white wares from Yunnan – Further discussions on links between bleu-and-white wares from Jingdezhen and from Viet Nam). *Meishu shi yanjiu jikan* 2008;25,171-270.

[27] Liem NQ, Colomban Ph, Quang VX, Tan HV, Hoanh TB. Identification of the Technologies Applied to Produce Ancient Vietnamese Ceramics on the Basis of Materials Sciences Studies. *Khao co hoc* (in Vietnamese) 2002;2,116-122.

[28] Colomban Ph. Polymerisation degree and Raman identification of ancient glasses used for jewellery, ceramics enamels and mosaics. *J Non-Cryst Solids* 2003;323,180-187.

[29] Colomban Ph, Sagon G, Huy LQ, Liem NQ, Mazerolles L. Vietnamese (15th century) blue-and-white, tam thai and lustre porcelains/stonewares: glaze composition and decoration techniques. *Archaeometry* 2004;46,125-136.

[30] Liem NQ, Colomban Ph. Applications of Modern Analysis Techniques in Searching Back Ancient Ceramic Technologies. *J Anal Sci Technol* MRS KOREA, International Symposium on Analytical Science and Technology November 15 -17, 2011. Korea Basic Science Institute, Daejeon; 2 (Suppl. A), 2011, A78-A83.

[31] Zhao B, Colomban Ph, Simsek G. La céramique vietnamienne importee en Arabie et en Afrique (XIVe-XVIe siècle). Colloque international de la SFECO 18-19 janvier 2013, *proceedings incoming*.

[32] Jiazhi L. The Evolution of Chinese Pottery and Porcelain Technology. In: Kingery WD, editor. *The Development of Chinese White Porcelain. Technology and Style, Ceramics and Civilization, Vol. I*. Columbus: The American Ceramic Society Inc; 1984, p. 135-162.

[33] Fleming SJ, Swann CP. Recent applications of PIXE spectrometry in archaeology II. Characterization of Chinese pottery exported to the Islamic world. *Nucl Instrum Meth B* 1992;64,528-537.

- [34] Wood N. *Chinese Glazes: Their Origin, Chemistry and Recreation*. London: University of Pennsylvania Press-A & C Black (Publishers) Ltd; 1999.
- [35] Yu KN, Miao JM. Characterization of blue and white porcelains using the Mn/Fe ratio from EDXRF, with particular reference to porcelains of the Xuande period (1426 to 1435 A.D.). *Appl Radiat Isotopes* 1999;**51**,279-283.
- [36] Chen T, Rapp Jr GR, Jing Z. Provenance studies of the earliest Chinese protoporcelain using instrumental neutron activation analysis. *J Archaeol Sci* 1999;**26**,1003-1015.
- [37] Lin EK, Yu YC, Wang CW, Liu TY, Wu CM, Chen KM, Lin SS. PIXE analysis of ancient Chinese Changsha porcelain. *Nucl Instrum Meth B* 1999;**150**,581-585.
- [38] Bin Z, Zhengyao G, Weijuan Z, Guoxia L, Huansheng C, Zhengquan Z, Mössbauer spectroscopy and neutron activation analysis of ancient Chinese glazes. *Appl Clay Sci* 2004;**25**,161-165.
- [39] Li BP, Greig A, Zhao JX, Collerson KD, Quan KS, Meng YH, Ma ZI. ICP-MS trace element analysis of Song dynasty porcelains from Ding, Jiexiu and Guantai kilns, north China. *J Archaeol Sci* 2005;**32**,251-259.
- [40] Li W, Li J, Deng Z, Wu J, Guo J. Study on Ru ware glaze of the Northern Song dynasty: one of the earliest crystalline-phase separated glazes in ancient China. *Ceramics Int* 2005;**31**,487-494.
- [41] Yang Y, Feng M, Ling X, Mao Z, Wang C, Sun X, Guo M. Microstructural analysis of the color-generating mechanism in Ru ware, modern copies and its differentiation with Jun ware. *J Archaeol Sci* 2005;**32**,301-310.
- [42] Li BP, Zhao JX, Greig A, Collerson KD. Characterisation of Chinese Tang sancai from Gongxian and Yaozhou kilns using ICP-MS trace element and TIMS Sr-Nd isotopic analysis. *J Archaeol Sci* 2006;**33**,56-62.
- [43] Xi G, Feng S, Feng X, Wang Y, Zhu J, Yan L, Li Y, Han H. Study of ancient Chinese imitated GE ware by INAA and WDXRF. *Nucl Instrum Meth B* 2007;**264**,103-108.
- [44] Kock LD, De Waal D. Raman studies of the underglaze blue pigment on ceramic artefacts of the Ming dynasty and of unknown origins. *J Raman Spectrosc* 2007;**38**,1480-1487.
- [45] De Waal D. Raman analysis of underglaze pigments on porcelain art. *J Raman Spectrosc* 2007;**38**(7),956-957.
- [46] Cui J, Rehren Th, Lei YB, Cheng X, Jiang J, Wu X, Western technical traditions of pottery making in Tang Dynasty China: chemical evidence from the Liquanfang Kiln site, Xi'an city. *J Archaeol Sci* 2010;**37**,1502-1509.
- [47] Yin M, Rehren T, Zheng J. The earliest high-red glazed ceramics in China: the composition of the proto-porcelain from Zhejiang during the Shang and Zhou periods (c. 1700-221 BC). *J Archaeol Sci* 2011;**38**,2352-2365.
- [48] Zhu T, Huang H, Wang H, Hu L, Yi X. Comparison of celadon

- from the Yaozhou and Xicun kilns in the Northern Song Dynasty of China by X-ray fluorescence and microscopy. *J. Archaeol Sci* 2011;**38**,3134-3140.
- [49] Figueiredo MO, Silva TP, Veiga JP. A XANES study of cobalt speciation state in blue-and-white ware glazes from 16th to 17th century Chinese porcelains. *J Electron Spectrosc* 2012;**185**,97-102.
- [50] Ma H, Zhu J, Henderson J, Li N. Provenance of Zhangzhou export blue-and-white ware and its clay source. *J Archaeol Sci* 2012;**39**,1218-1226.
- [51] Kock LD. Raman analysis of glaze on various archaeological shard samples and intact Ming plates. *J Raman Spectrosc* 2013;**44**,97-101.
- [52] Vieira Ferreira LF, Casimiro TM, Colomban Ph. Portuguese tin-glazed earthenware from the 17th century: pigments and glazes characterization. *Spectrochim Acta A* 2013;**104**,437-444.
- [53] Papadopoulou DN, Zachariadis GA, Anthemidis AN, Tsirliganis NC, Stratis JA. Development and optimisation of a portable micro-XRF method for in situ multi-element analysis of ancient ceramics. *Talanta* 2006;**68**,1692-1699.
- [54] Frahm E. Validity of “off-the-shelf” handheld portable XRF for sourcing Near Eastern obsidian chip debris. *J Archaeol Sci* 2013;**40**,1080-1092.
- [55] Gauss RK, Batora J, Nowaczinski E, Rassmann K, Schukraft G. The Early Bronze Age settlement of Fidvar, Vrable (Slovakia): reconstructing prehistoric settlement patterns using portable XRF. *J Archaeol Sci* 2013;**40**,2942-2960.
- [56] Mitchell D, Grave P, Maccheroni M, Gelman E. Geochemical characterization of north Asian glazed stonewares: a comparative analysis of NAA, ICP-OES and non-destructive pXRF. *J Archaeol Sci* 2012;**39**,2921-2933.
- [57] Speakman RJ, Little NC, Creel D, Miller MR, Iñáñez JG. Sourcing ceramics with portable XRF spectrometers? A comparison with INAA using Mimbres pottery from the American Southwest. *J Archaeol Sci* 2011;**38**,3483-3496.
- [58] Roldan C, Coll J, Ferrero J. EDXRF analysis of blue pigments used in Valencian ceramics from the 14th century to modern times. *J Cult Herit* 2006;**7**,134-138.
- [59] Pappalardo G, Costa E, Marchetta C, Pappalardo L, Romano FP, Zucchiatti A, Prati P, Mandò PA, Migliori A, Palombo L, Vaccari MG. Non-destructive characterization of Della Robbia sculptures at the Bargello museum in Florence by the combined use of PIXE and XRF portable systems. *J Cult Herit* 2004;**5**,183-188.
- [60] Bezur A, Casadio F. The analysis of porcelain using handheld and portable x-ray fluorescence spectrometer. In: Shugar A, Mass J, editors. *Studies in Archaeological Sciences: Handheld XRF for Art and Archaeology*. Leuven: Leuven University Press; 2013, p.249-311.
- [61] Liem NQ, Sagon G, Quang VX, Tan HV, Colomban Ph. Raman study of the microstructure, composition and processing of ancient

- Vietnamese (proto)porcelains and celadons (13-16th centuries). *J Raman Spectrosc* 2000;**31**,933-942.
- [62] Liem NQ, Thanh NT, Colomban Ph. Reliability of Raman micro-spectroscopy in analysing ancient ceramics: the case of ancient Vietnamese porcelain and celadon glazes. *J Raman Spectrosc* 2002;**33**,287-294.
- [63] Colomban Ph, Liem NQ, Sagon G, Tinh HX, Hoành TB. Microstructure, composition and processing of 15th century Vietnamese porcelains and celadons. *J Cult Herit* 2003;**4**,187-197.
- [64] Rougeulle A. The Qalhât Project. New researches at the mediaeval harbour site of Qalhât, Oman 2008. *Proceedings of the Seminar for Arabian Studies* 2010;**40**,315-332.
- [65] Rougeulle A, Creissen Th, Bernard V. The great mosque of Qalhât rediscovered. Main results of the 2008-2010 excavations at Qalhât, Oman. *Proceedings of the Seminar for Arabian Studies* 2012; **42**, p. 341-356.
- [66] Colomban Ph, Tournié A. On-site Raman identification and dating of ancient/modern stained glasses at the Sainte Chapelle, Paris. *J Cult Herit* 2007;**8**,242-256.
- [67] Colomban Ph. On-site Raman identification and dating of ancient glasses: procedures and tools. *J Cult Herit* 2008;**9**,e55-e60.
- [68] Colomban Ph. The on-site/remote Raman analysis with portable instruments - A review of drawbacks and success in Cultural Heritage studies and other associated fields. *J Raman Spectrosc* 2012;**43**(11),1529-1535.
- [69] Colomban Ph, Paulsen O. Non-Destructive Determination of the Structure and Composition of Glazes, *J Am Ceram Soc* 2005;**88**,390-395.
- [70] Colomban Ph, Tournié A, Bellot-Gurlet L. Raman Identification of glassy silicates used in ceramics, glass and jewellery: a tentative differentiation guide, *J Raman Spectrosc* 2006;**37**,841-852.
- [71] Colomban Ph. Rocks as blue (green and black) pigments/dyes of glazed pottery and enamelled glass artefacts – A review. *Eur J Mineral* 2013; in press.
- [72] Colomban Ph, Calligaro Th, Vibert-Guigue Cl, Liem NQ, Edwards HGM. Accrochage des dorures sur les céramiques et tesselles anciennes, *Revue d'Archéométrie-Archeosciences* 2006;**29**,7-20.
- [73] Morimoto A, Yamasaki K, editors. *Technical Studies on Ancient Ceramics Found in North and Central Vietnam*. Fukuoka; 2001.
- [74] Gratuze B, Soulier I, Barrandon JN, Foy D. De l'origine du cobalt dans les verres. *Revue d'Archéométrie* 1992;**16**,97-108.
- [75] Gratuze B, Soulier I, Blet M, Vallauri L. De l'origine du cobalt: du verre à la céramique. *Revue d'Archéométrie* 1996;**20**,77-94.
- [76] Colomban Ph, Prinsloo LC. Optical Spectroscopy of Silicates and Glasses. In: Yarwood J, Douthwaite R, Duckett SB, editors. *Spectroscopic Properties of Inorganic and Organometallic Compounds*. RSC Publishing, The Royal Society of Chemistry; 2009, p.128-149.

- [77] Colomban Ph, Treppoz F. Identification and differentiation of ancient and modern European porcelains by Raman macro- and micro-spectroscopy. *J Raman Spectrosc* 2001;32,93-102.
- [78] Colomban Ph, Robert I, Roche C, Sagon G, Milande V. Identification des porcelains “tendres” du 18ème siècle par spectroscopie Raman: Saint-Cloud, Chantilly, Mennecey et Vincennes/Sèvres. *Revue d'Archéométrie* 2004;28,153-167.
- [79] Iqbal Y, Lee WE. Microstructural evolution in triaxial porcelain. *J Am Ceram Soc* 2000;83,3121-3127.
- [80] Carty WM, Senapati U. Porcelain-Raw Materials, Processing, Phase Evolution and Mechanical Behaviour. *J Am Ceram Soc* 1998;81,3-20.
- [81] McMillan P. Structural studies of silicate glasses and melts -- applications and limitations of Raman spectroscopy. *Am Mineral* 1984;69,622-644.
- [82] Scott R. Southern Chinese Provincial Kilns: Their Importance and Possible Influence on South East Asian Ceramics. In: Scott R, Guy J, editors. *South East Asia and China Art: Interaction and Commerce, Colloquies on Art & Archaeology*. London: Percival David Foundation of Chinese Art, 1995;17,187-204.

Group	Sample	Code	Origin	Thickness, mm	Body colour
Brown & Ivory	CS 2000A2	BI-Ly	Ly Son	14.45	Ivory
Celadon	HLS9HIL20_B15L0	C-HL1	Ha Lan	6.30	Ivory
	HLS9HIL23_B16L3	C-HL2	Ha Lan	3.85	Ivory
	HLS9HIL23A_B16L	C-HL3	Ha Lan	4.15	Ivory
	HLS9HIL23HO23_B16O3	C-HL4	Ha Lan	5.60	Ivory
	HL91ST_44A_N134A	C-HL5	Ha Lan	5.45	Ivory
	MCDa	C-CD1	Chu Đâu	4.35-5	Ivory
	CD89ST42_PK21	C-CD2	Chu Đâu	8.25	Ivory
	Mxh3	C-CDmx1	CD-My Xa	4.30-4.65	White
	345_39	C1	Qalhät	10.20	Light beige
	345_1	C2	Qalhät	5	Ivory
	956_14	C3	Qalhät	7.60-15.50	Ivory
	19C	C-Kor	Korean	3.70-22	Red
	NTSOOH2L1_ech2	C-KQ1	Ngu Hanh Son	4.50	Ivory
	NTSOOH2L2	C-KQ2	Ngu Hanh Son	5.90-12.70	Dark beige
	NTSOOH2L2_round_ech	C-KQ3	Ngu Hanh Son	8.60	Dark beige
	NG.99 M5	C-KQ4	Ngu Hanh Son	3.80	Beige
BT401	C-BT1	Bat Trang	4	Ivory	
Iron Brown	329_1	IB1	Qalhät	4.35	Beige
	1446_2	IB2	Qalhät	4.20-4.60	Ivory
	313-4	IB3	Qalhät	8.90-19.70	Beige
White	CD02M7	BW-CD1	Chu Đâu	4.30	Dark beige
Blue & White	CD02-M4	BW-CD2	Chu Đâu	5.15	Light beige
	CD02-M6	BW-CD3	Chu Đâu	9.70	Beige
	MCDa	BW-CD4	Chu Đâu	3-3.35	Ivory
	CD_A	BW-CD5	Chu Đâu	6.45	Ivory
	CD_H2	BW-CD6	Chu Đâu	4.85	Ivory
	MCDc	BW-CD7	Chu Đâu	9.40-22.70	Ivory
	CLCc	BW-CLC1	Củ Lao Chàm	8	Beige
	1026_1	BW1	Qalhät	4.25-6	Beige
	1152_2	BW2	Qalhät	7.80	Ivory
	1430_10	BW3	Qalhät	10.25	Beige
	1434_46	BW4	Qalhät	7.20-10	Ivory
	1003_8	BW5	Qalhät	2.80	White
	1430_1	BW6	Qalhät	3.45-4	Ivory
	323_65	BW7	Qalhät	10-20	Light beige
	Nau_Surconf_ech2	BW-Ch1	China	2.95	White
	Nau_Surconf_1615	BW-Ch2	China	3.70-5	White
	Abrantes_11_04_83	BW-Ch3	China	2.85	White
	VH50_17_11_1799	BW-Ch4	China	11	White
	VDKBH1L2_ech2	BW-KQ1	Ngu Hanh Son	4.15	Ivory
	VDKBH1L3	BW-KQ2	Ngu Hanh Son	3.35	Ivory
	VDKBH1L2	BW-KQ3	Ngu Hanh Son	3.55	Light beige
	H1a	BW-Hu1	Hoa Lu	3.75	White
	H1b	BW-Hu2	Hoa Lu	4.2-6.8	White
	BP1	BW-Hu3	Hoa Lu	4.7-8.8	White
	BF1	BW-Hu4	Hoa Lu	3.1	White
	Modern porcelain	BW-JP1	Japan	3.85	White
Multicolour	Myza	MC-CDmx1	CD-My Xa	3.7	Beige
	CLC_J	MC-CDmx2	CD-My Xa	3.15	Ivory
	CLCa	MC-CDmx3	CD-My Xa	2.85	Ivory
	CLCe	MC-CLC1	Củ Lao Chàm	4.8	Ivory
	CLCc_2002	MC-CLC2	Củ Lao Chàm	5.9-10.7	Beige
	CLCa_2002	MC-CLC3	Củ Lao Chàm	3.35	Ivory
	CLCb_2002	MC-CLC4	Củ Lao Chàm		
	Modern 1999	MC-BT1/BT3	Bat Trang	5.4	Ivory

Table 1: Detailed description of ceramics studied.

Sample	Origin	interphase thickness (μm)	Glaze thickness (μm)	Over/Under-glaze décor
Surcouf-1	China	No	400	under
Qianlong	China	No	750	under
CDa	Viêt Nam	300	550	over
MCDc	Viêt Nam	150	450	over
CLCc	Viêt Nam	250	750	over
CD87	Viêt Nam	350	500	over
MCDa	Viêt Nam	180	200	over
CLCa	Viêt Nam	no	300	over
MyXa-30	Viêt Nam	120	400	over
345-39	Qalhât	250	550	under
323-65	Qalhât	200	350	under
313-4	Qalhât	240	350	under
329-1	Qalhât	120	400	under
1446-2	Qalhât	180	450	under
1026-1	Qalhât	350	650	over
1152-2	Qalhât	300	700	over
1430-10	Qalhât	250	550	over
1434-46	Qalhât	no	1000	under
1003-8	Qalhât	no	400	under

Table 2: Slip and glaze thickness measured for Qalhât and reference samples.

Material	SiO ₂	Al ₂ O ₃	Na ₂ O	K ₂ O	CaO	Fe ₂ O ₃	PbO	CuO	CoO	Au/Ag
Body	72	22	<1	2.8	<1	<1	nm	-	-	-
Slip	80	14	<0.5	2.8	2.2	<1	-	-	-	-
Glaze	68	13	1.4	3.2	10.6	<1	-	-	-	-
Red g	65	13	0.6	2.6	10.3	4.2	1.3	-	-	-
Blue g	76	9.9	0.4	2.1	6	variable	-	-	0.5	-
Green g	28	5.4	-	0.5	4.2	-	53.5	3.7	-	-
Gold	-	-	-	-	-	-	-	-	-	95/5
Ming g	71.4	12	1.4	4.4	9.2	0.7	0.01	-	-	-
Ming blue g	71.4	12	1.4	4.8	7.3	1	-	-	0.2	-

Table 3: Composition measured on Cù Lao Chàm tam thai shard (Colomban et al., 2003; Colomban et al., 2004a); g: glaze; n.m.: not measured. A comparison with colourless and blue Ming porcelain glaze is given (Vieira Ferreira et al., 2013).

Phase	Composition	Main Raman peak (cm ⁻¹)
mullite	3Al ₂ O ₃ SiO ₂	409, 955
quartz	SiO ₂	409, 463, 800, 955, 205, 354, 448, 605, 1160
calcite	CaCO ₃	1086
feldspar	MA ₁ SiO ₈	508
hematite	α -Fe ₂ O ₃	222, 290, 406, 501, 1320
magnetite	Fe ₃ O ₄	666
plomb	Pb ₃ SiO ₄	964
wollastonite	CaSiO ₃	970
crystalite	SiO ₂	228, 418
rutile	TiO ₂	400, 615
cerussite	PbCO ₃	1055
sp ³ & sp ² carbone	C	~1350 & 1600

Table 4: Main phases and their Raman signatures characteristics of glazed stoneware/porcelains (Liem et al., 2000; Colomban & Treppoz, 2001; Liem et al. 2002a; Colomban et al., 2004b).

Samples	ν , cm ⁻¹	δ , cm ⁻¹	I _p
CLCc	955/1040	496	2.4
CLCe	944/1017	479	2.2
MCDc	965/1046	460	1.3
CD87	1003	492	1.2
MyXa-30	945	469	1
BW1	976/1066	450	0.8
BW2	947/1029	462	1.1
BW3	953/1015	472	1.1
BW4	954/1040	472	1.3
C1	928/1072	475	1.2
C3	958/1050	483	1
IB1	958/1048	483	1.8
IB3	952/1028	498	1.2

Table 5: Raman parameters of glazes (ν , stretching band; δ , bending band and I_p, polymerization index)

Fig. 1. Qalhât shards assigned to Vietnamese-like productions: a) monocolour and celadon glazed stonewares; b) iron-brown painting stoneware; c) blue-and-white ware.

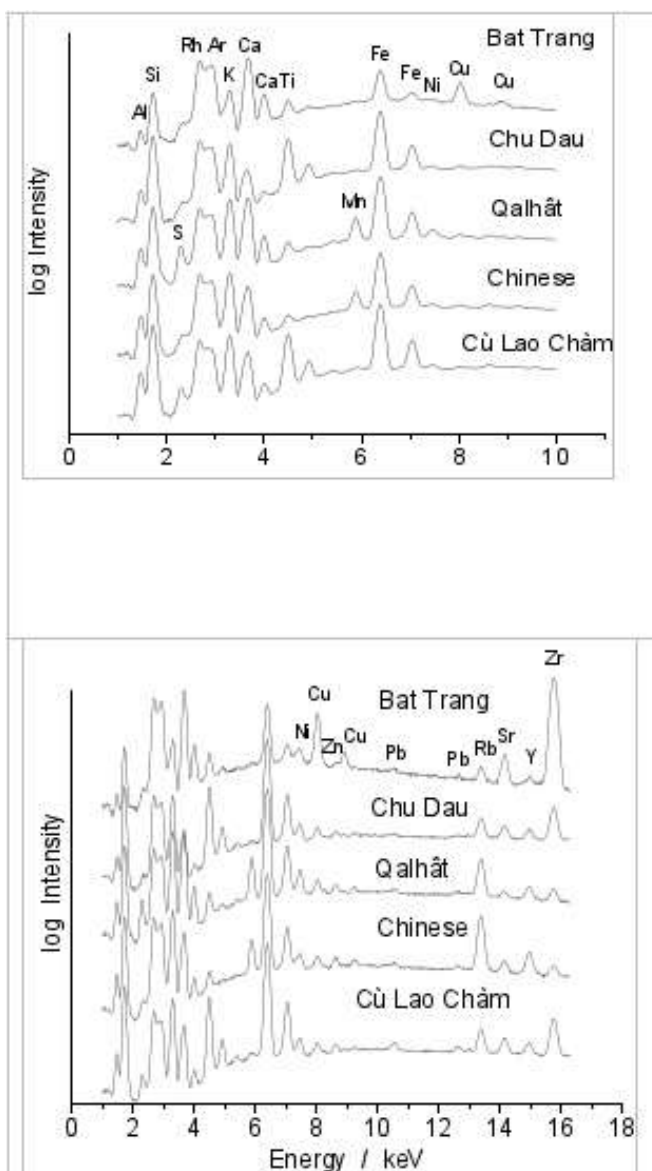
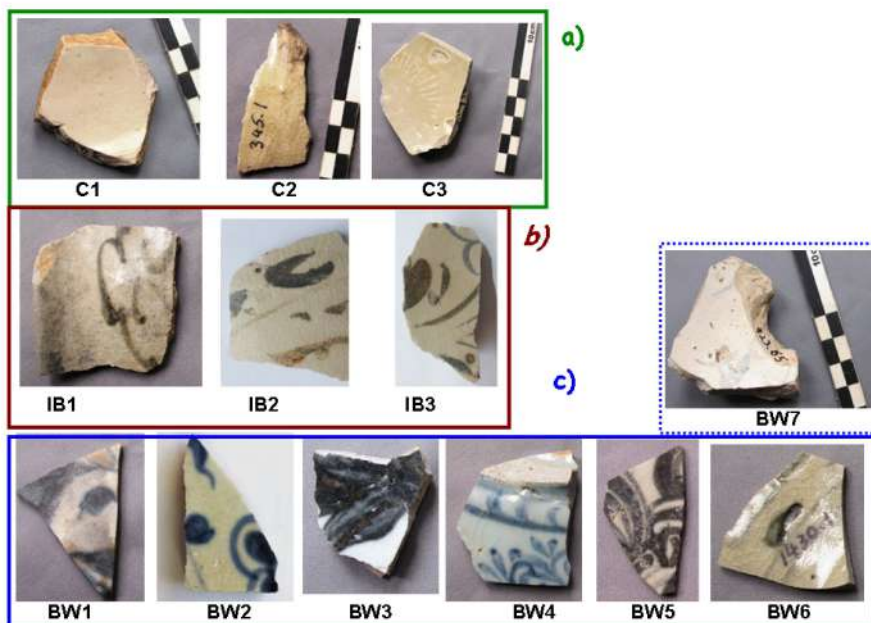

Fig. 2. Representative XRF spectra recorded at low, 15 kV (a) and high, 40 kV (b) voltages.

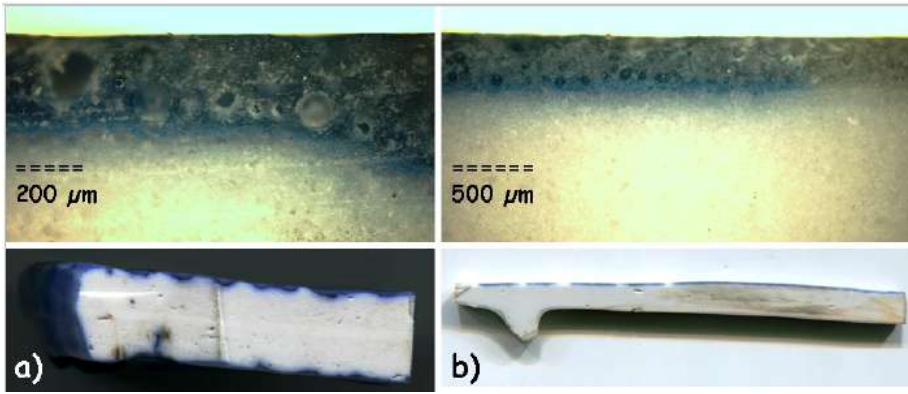

Fig. 3. Representative shards and their sections of blue-and-white Chinese porcelains: a) Qianlong (1736-1796) and b) Surcouf's shipwreck cargo (17th c.)

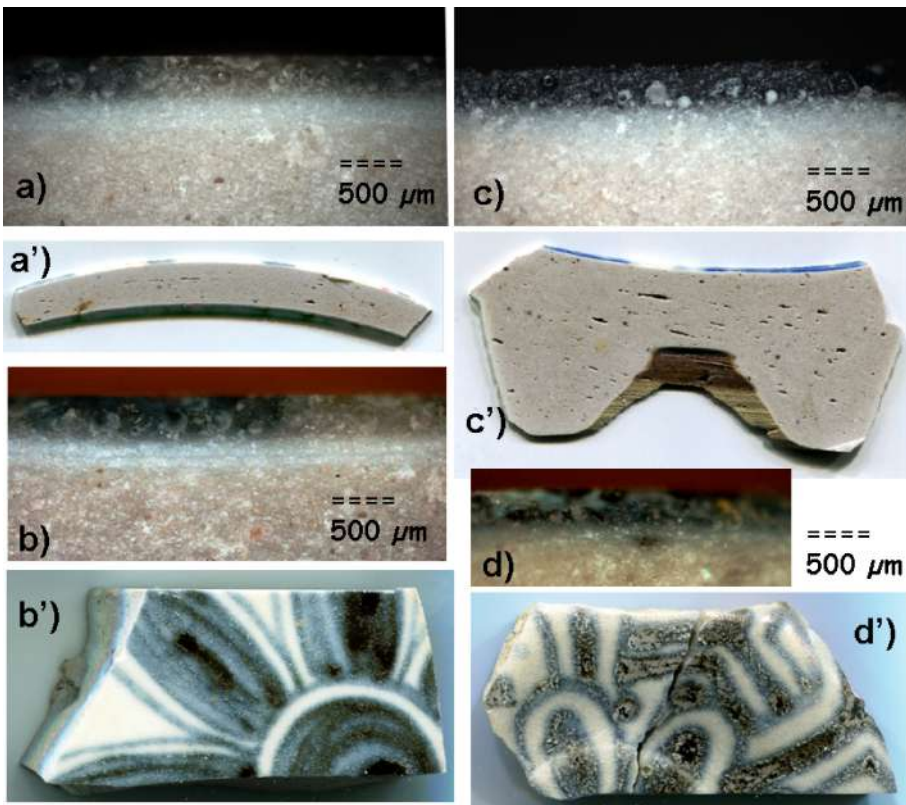

Fig. 4. Representative shards and their sections of two Chu Đâu blue-and-white 'porcelains'.

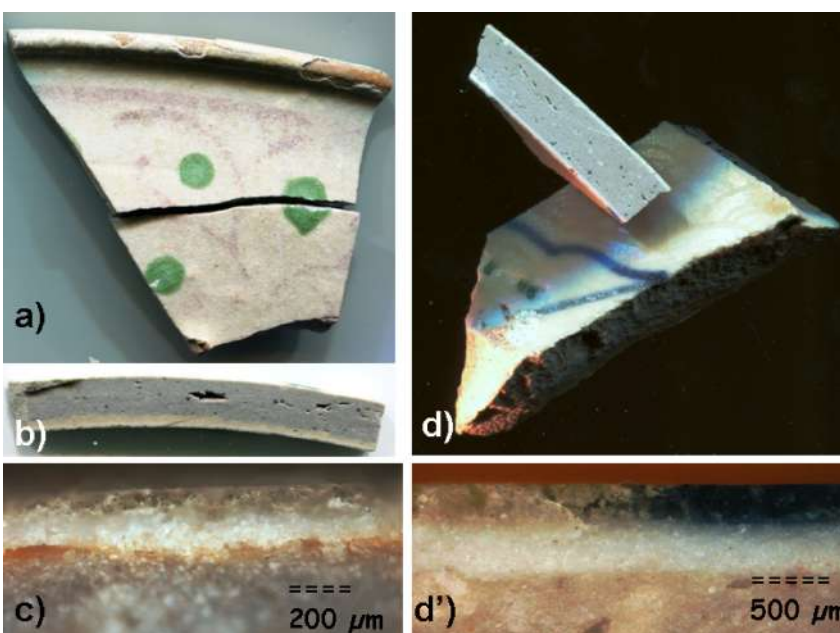

Fig. 5. Representative tam thai My Xa and Cù Lao Chàm multicolour wares and their sections.

Fig. 6. Representative 'iron brown' painting stoneware from Qalh t and its section.

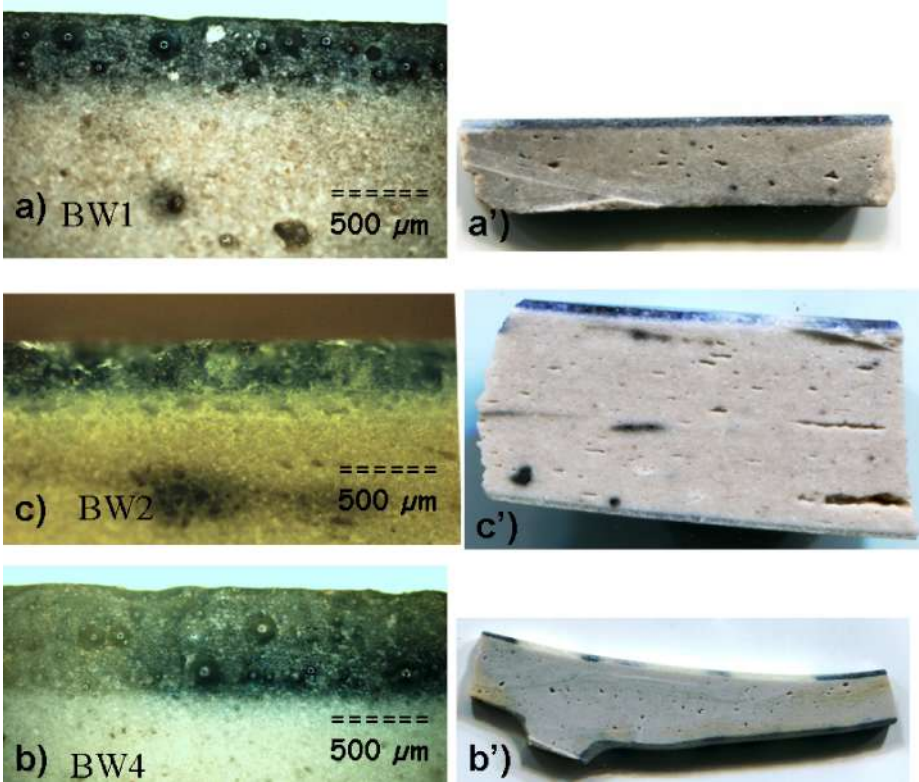
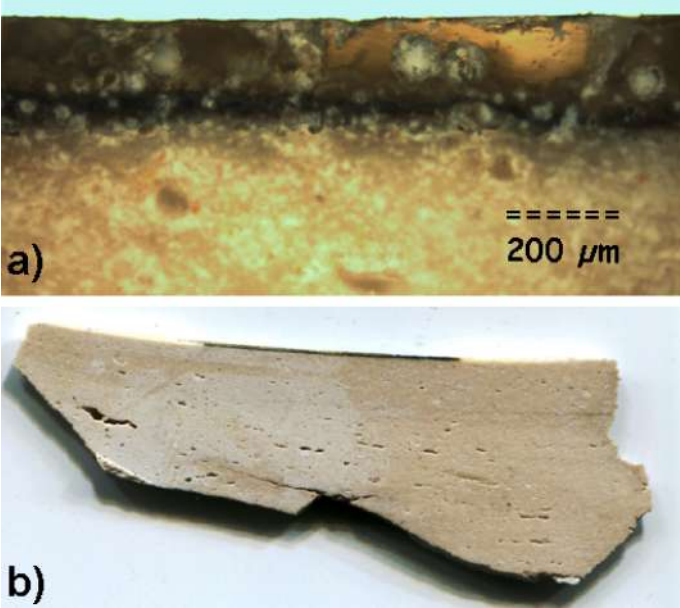

Fig. 7. Representative shards and their section in 'blue & white' ware from Qalh t.

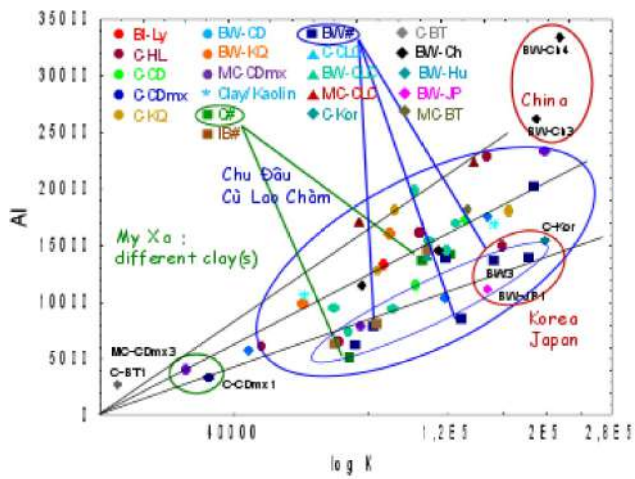

Fig. 8. Plot of the Al vs. the logarithmic K XRF peak intensity measured on sample body. Data measured for ancient Chinese, Korea (Koryo celadon), modern blue-and-white Japanese potteries are labeled. (C: celadon or monocolour shards; BW: blue-and-white shard; BI: Brown and Ivory; IB: Iron brown painting stoneware, MC: multicolour ware; Ly: Ly Dynasty ware, Hanoi citadel excavation; HL: Ha Lan kiln ware; CD: Chu Đâu kiln ware; KQ: Ngu Hanh Son ware; MX: My Xa kiln multicolour ware; JP: Japan ware; Kor: Korea Goryo ware; Ch: China ware; BT: Bat tràng kiln ware; Clay/Kaolin: from Chu Đâu excavation)

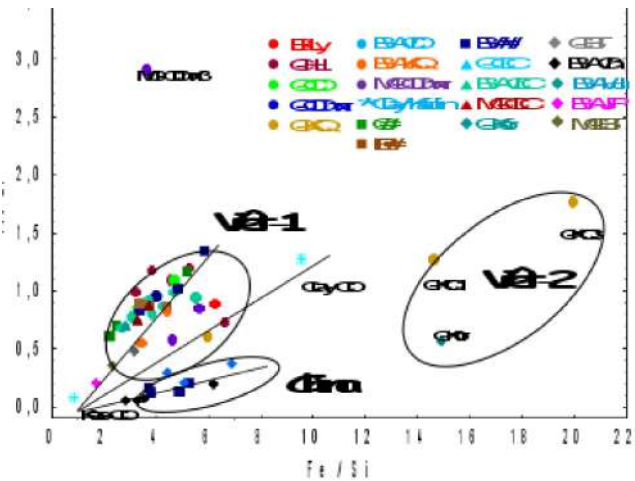

Fig. 9. Plot of the Ti vs. Fe XRF peak intensity measured on sample body. Data have been normalized with Si peak intensity for a better comparison. See Fig. 8 for labels.

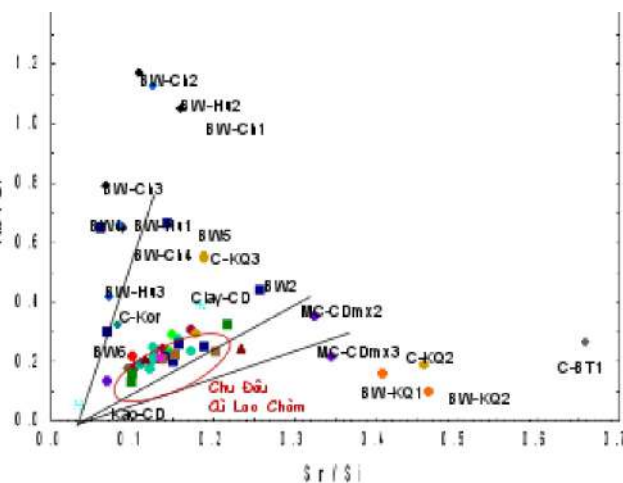

Fig. 10. Plot of the Rb vs. Sr XRF peak intensity measured on sample body. Data have been normalized with Si peak intensity for a better comparison. See Fig. 8 for labels.

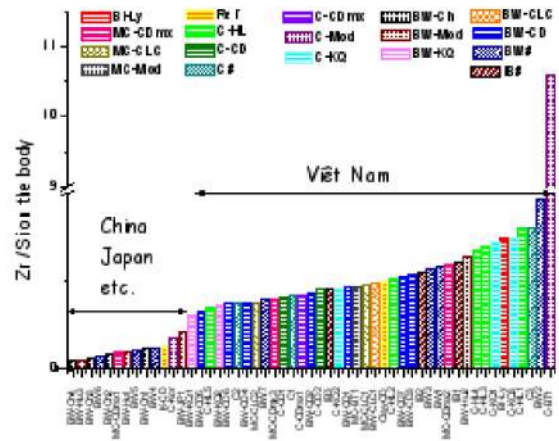

Fig. 11. Plot of the Zr XRF peak intensity measured for the body (top) and the glaze (bottom). Data have been normalized with Si peak intensity for a better comparison. See Fig. 8 for labels.

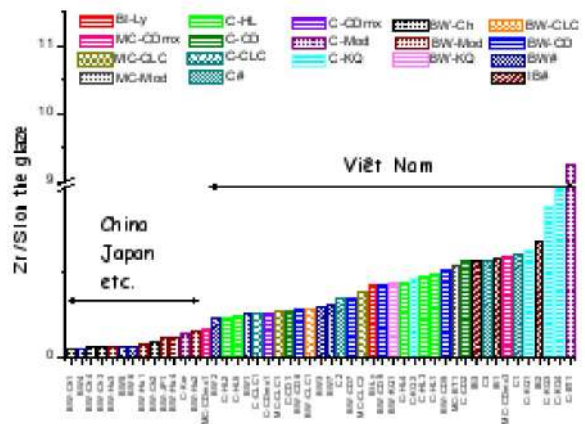
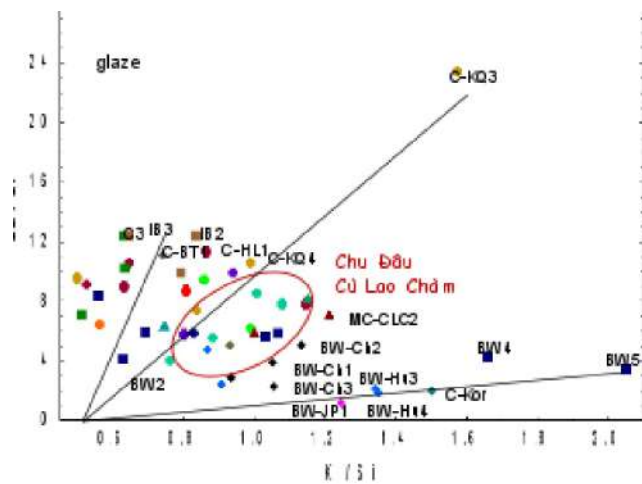

Fig. 12. Plot of the Ca vs. K XRF peak intensity measured on the glaze. Data have been normalized with Si peak intensity for a better comparison. See Fig. 8 for labels.



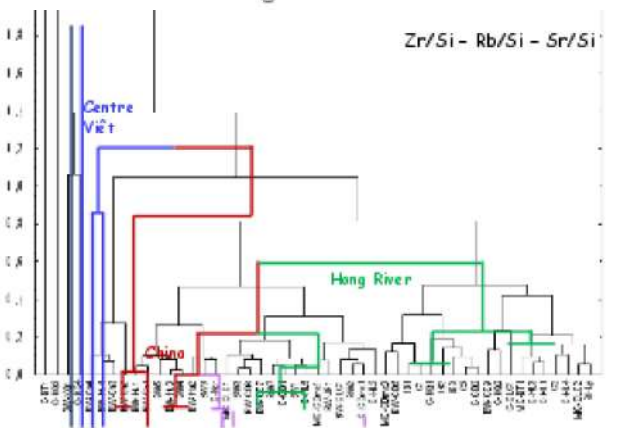
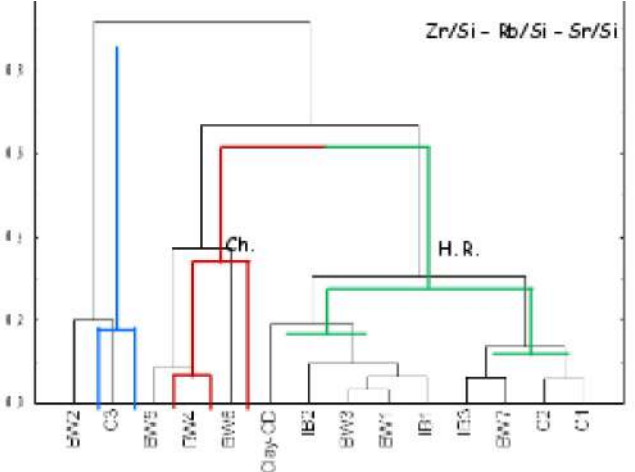
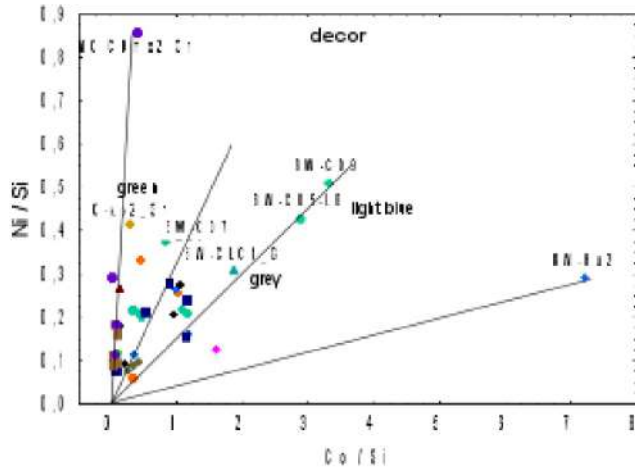
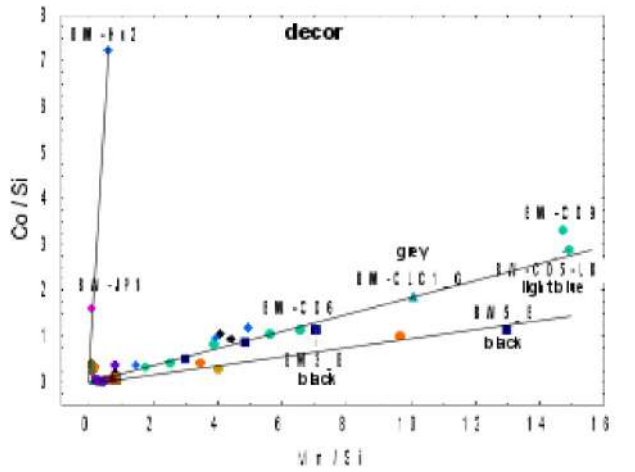

Fig. 13. Plot of the Co vs. Mn, Ni vs. Co XRF peak intensity. Data have been normalized with Si peak intensity for a better comparison. See Fig. 8 for labels.

Fig. 14. Dendrograms of the aggregation distances on the body representing only Qalh t shards (top) and the glaze representing all analyzed shards of different origins (bottom) comparing with the Zr, Rb, Sr content normalized by Si. (Ch. China, H.R. Hong River, and B&W blue-and-white shards)

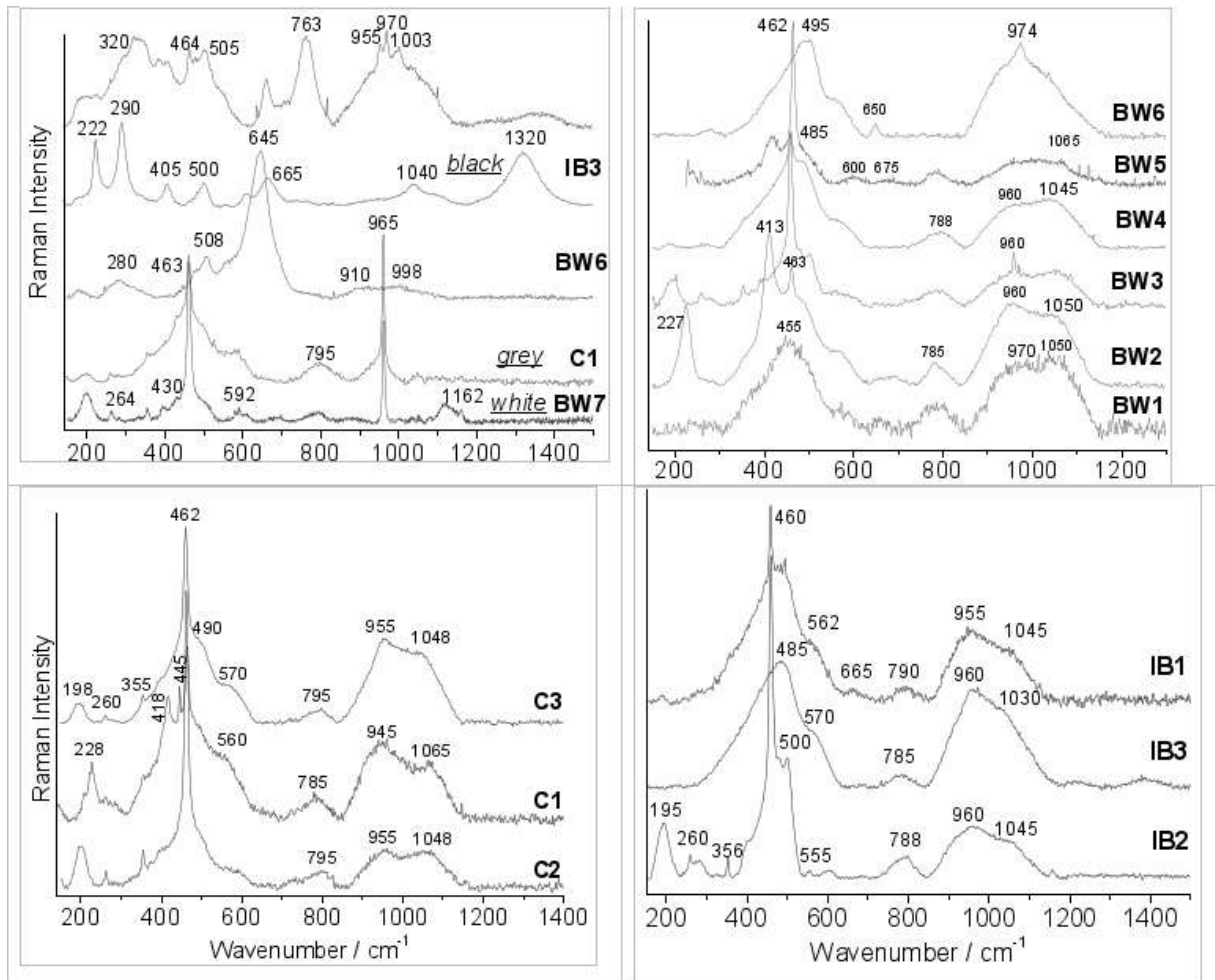

Fig. 15. Representative Raman spectra recorded for glazed pottery.