



**HAL**  
open science

# Designing Hybrid Vehicle Architectures: Utilizing an Automatic Generation and Optimization Approach

Bilal Kabalan, Emmanuel Vinot, Rochdi Trigui, Clement Dumand

► **To cite this version:**

Bilal Kabalan, Emmanuel Vinot, Rochdi Trigui, Clement Dumand. Designing Hybrid Vehicle Architectures: Utilizing an Automatic Generation and Optimization Approach. IEEE Vehicular Technology Magazine, 2021, 16 (2), pp.76-85. 10.1109/MVT.2021.3061988 . hal-03328968

**HAL Id: hal-03328968**

**<https://hal.science/hal-03328968>**

Submitted on 30 Aug 2021

**HAL** is a multi-disciplinary open access archive for the deposit and dissemination of scientific research documents, whether they are published or not. The documents may come from teaching and research institutions in France or abroad, or from public or private research centers.

L'archive ouverte pluridisciplinaire **HAL**, est destinée au dépôt et à la diffusion de documents scientifiques de niveau recherche, publiés ou non, émanant des établissements d'enseignement et de recherche français ou étrangers, des laboratoires publics ou privés.

# Design of Hybrid Vehicle Architectures Using an Automatic Generation and Optimization Approach

Bilal Kabalan, Gustave Eiffel University, IFSTTAR  
 Emmanuel Vinot, Gustave Eiffel University, IFSTTAR  
 Rochdi Trigui, Gustave Eiffel University, IFSTTAR  
 Clément Dumand, Groupe PSA

*Different architectures for hybrid powertrains exist. To compare their efficiency, traditionally one energetic model is developed per architecture and is optimized. This heuristic approach can be replaced today by a systematic method that explores all possibilities in a defined search space. This article presents HEVs optimization and comparison using an automatic methodology for architectures generation. The components of series-parallel hybrid architecture, except planetary gears, are chosen as starting components. All the possible architectures are generated and then filtered to determine the most promising ones. The latter are automatically assessed and optimized using a general hybrid model. The process includes a genetic algorithm for the design optimization and dynamic programming for the control optimization. Given two different objectives to minimize, namely the battery size and the fuel consumption in our considered case, the Pareto fronts of the most promising architectures are presented and compared to the Pareto fronts of reference series-parallel architectures. Several of the filtered architectures are found to be better than the references (consumption about 5% lower). In addition, a gain in powertrain sizing and cost is found. The best architecture is finally revealed and its operation is analyzed to determine the functionalities that lead to its energy efficiency.*

**Index Terms**—Powertrain design, architecture comparison, hybrid electric vehicles, optimization, sizing, genetic algorithms, dynamic programming, constraint programming, architecture generation.

## Introduction

The automakers are proposing more electric and hybrid vehicles on the market, in the aim of meeting the fleet-wide average CO<sub>2</sub> emission targets which are quite unreachable with conventional powertrains.

Different challenges are associated with these proposed vehicles. Battery Electric Vehicles (BEV) are challenged by their battery (autonomy, charging time, cost...) but they have a relatively simple powertrain architecture. (P)HEV (referring to Hybrid and Plug-in Hybrid Electric Vehicle) are challenged by the complexity of their powertrain design. In fact, they combine a battery electric traction system with a conventional engine-based traction system. The connection between the two systems can be made through different means resulting in different architectures. Series, parallel and series-parallel (power-split and non-power-split) are the main three categories. Within a category, numerous variants exist depending on the position of the powertrain components and the presence of gears or gearboxes. The architecture design space is therefore big and not limited to the choice between the three main categories.

This choice of architecture is crucial in the powertrain design. It impacts the vehicle performance and fuel consumption along with the components sizing and powertrain cost. Researchers and automakers put effort in searching for the best architecture for a given application.

## State of the art in architectures comparison

### a) Manual comparison

Traditionally, this comparison is done in a non-systematic way (Figure 1, left). Benchmark architectures are selected, an energetic model is manually developed for each and is optimized, then the architectures are compared [1].

In other works, powertrain efficiency improvements are investigated by doing some manual architecture modification [2][3][4]. For instance, in [2] the authors of the present article consider the addition of gears and gearbox on a simple series-parallel architecture. Different variants are suggested, modelled, optimized and compared, all in a non-automatic way.

Further, general models are sometimes used to simulate the few studied architectures [5]. Platforms that allow the comparison between combinations of vehicle application, architectures, components choice, sizing, and control are also proposed.

With the manual modelling and comparison approach, the architecture design space was not sufficiently explored. In fact, it is infeasible to manually list and model all the architectures as the combinations between components are numerous. Automation of the exploration of architectures is then required.

### b) Automatic comparison

The automation of the entire process is ongoing in the literature. Exploration of the architecture design space by automatic generation of architectures started to be performed in some works. In [6], power-split architectures are generated and compared. The control problem is

solved using a non-optimal but fast technique. In [7], constraint-programming is used to generate architectures without evaluating them. Automated physical modelling and filtering is then added in [8] without design optimization, and while neglecting the transmission losses.

### Contribution and outline

This article presents the entire process of generating and optimizing HEVs architectures in an automatic way. A comparison of the classical methodology used in previous works [2] and the methodology used in this work is presented in Figure 1. In the proposed approach, starting from a set of chosen components, all the possible architectures are generated, filtered and automatically assessed and optimized using a specifically developed general hybrid model. The Pareto fronts corresponding to a multi-objective (two in this article) assessment of the architectures are finally compared.

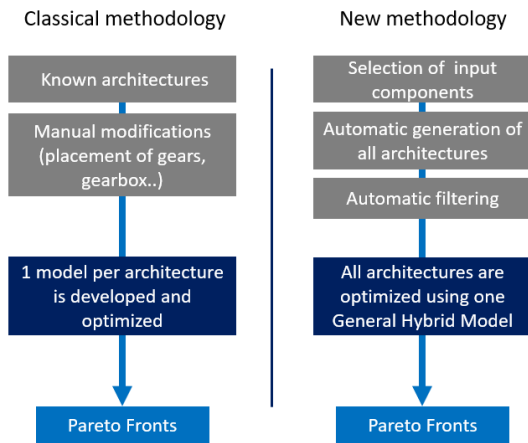

Figure 1: The classical methodology in [2] vs the proposed methodology

In the following, the methodology used to generate and optimize the architectures is explained in chapter 2. A case study is performed in chapter 3 using the components of a series-parallel architecture. The selected architectures are compared and the optimal sizing is analyzed. The best architecture is clearly revealed in chapter 4 and its operation is closely analyzed to determine the functionalities that lead to its energy efficiency.

### Methodology

The methodology used is overviewed in this chapter. First, a main block which allows the assessment of all the generated architectures is presented. This general hybrid model can assess the efficiency of all the generated hybrid architectures, without the need to manually model them one by one. The automatic generation of architectures is then detailed and a short reminder on the bi-level optimization is presented.

### General hybrid model

This specifically developed general hybrid model calculates the dynamic performance and fuel consumption of all the generated architectures. It includes nine possible modes that the architectures can have, listed in the Automatic Filtering section. In this model, all the components are connected by simplified virtual links that have one gear with a ratio and efficiency (Figure 2). These are the global ratio and efficiency of the considered power path. This information will be automatically detected for each of the architectures: after the architectures being generated and the mechanical connections between the components being defined, an automatic analysis is done to

calculate for each link between two components the global efficiency and ratio. In this manner, different architectures can be simulated using the same model and by changing only the links global values. This model will be inserted inside a bi-level optimization technique that uses a Genetic Algorithm to optimize the sizing of the powertrains and Dynamic Programming to optimize their control.

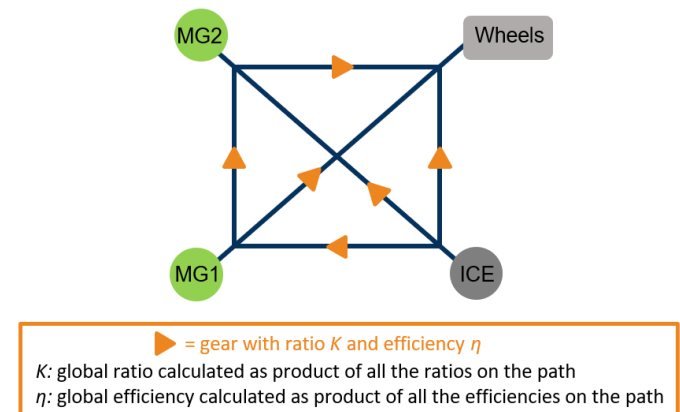

Figure 2: The general hybrid model

This model is required to simulate and optimize the generated and filtered architectures. The automatic generation, filtering and optimization steps of the methodology are explained hereafter.

### Design input

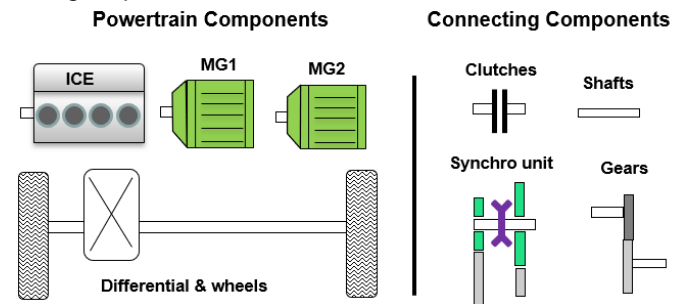

Figure 3: Input components

The design inputs are first defined. For a first version of the method that excludes planetary gears, the considered inputs are shown in Figure 3: they are the available powertrain components (internal combustion engine ICE, motor generators MG, Differential & wheels), the available connecting components (clutches, shafts, gears, synchro unit), and the specifications (vehicle requirements, objective functions to optimize).

Synchro units, key components here for the mechanical connections, are classically seen in manual gearboxes. A unit consists of a synchronizer (in violet in Figure 3) and two pairs of gears. In each pair of gears, one gear is fixed to a shaft (the grey gear) and one is free spinning (the green) and connects to a shaft through the synchronizer. Functionally, the unit allows three options: disconnection, connection through a gear ratio 1, connection through a gear ratio 2. The two grey gears can be connected to one same shaft (case of conventional gearboxes) or two different shafts (case of new-trend dedicated hybrid gearboxes).

### Automatic generation of all possible architectures

The connections between the components in a hybrid powertrain architecture can be described in what is called an adjacency matrix. It is a  $n$  by  $n$  matrix where the columns and the rows are the components  $V_0, \dots, V_{n-1}$ , and each cell  $X_{i,j}$  at index  $(i, j)$  takes a 0 or 1

value describing the absence (0) or presence (1) of connection between the component  $V_i$  and the component  $V_j$ .

$$\begin{matrix} & V_0 & V_1 & \dots & V_j & \dots & V_{n-1} \\ \begin{matrix} V_0 \\ V_1 \\ \vdots \\ V_i \\ \vdots \\ V_{n-1} \end{matrix} & \begin{bmatrix} 0 & 1 & \dots & \cdot & \dots & \cdot \\ 1 & 0 & \dots & \cdot & \dots & \cdot \\ \vdots & \vdots & \vdots & \vdots & \vdots & \vdots \\ \vdots & \vdots & \vdots & X_{i,j} & \dots & \cdot \\ \vdots & \vdots & \vdots & \vdots & \vdots & \vdots \\ \vdots & \vdots & \vdots & \vdots & \vdots & \vdots \end{bmatrix} & \end{matrix} \quad (1)$$

$$X_{i,j} = \begin{cases} 0 & \Rightarrow \text{absence of connection between } V_i \text{ and } V_j \\ 1 & \Rightarrow \text{presence of connection between } V_i \text{ and } V_j \end{cases}$$

The values of all the cells are the variables of the problem. They are related through some constraints regarding the component connection, mechanical feasibility, powertrain functionality and the non-repeatability of the components. The constraints used are listed hereafter:

- The values in the matrix diagonal are all 0 because a component cannot be connected to itself.
- The components cannot be interconnected, they can be connected to ‘shafts’ only.
- A minimum and maximum number of connections is set for each component. The shafts can have between 2 to 6 connections, the powertrain components can have only 1 connection, the clutches and gears 2 connections, the synchro unit between 2 to 3 connections.
- ICE and FD cannot be connected to the same shaft (idling and minimum rotation speed constraint).
- MG1 and MG2 cannot be connected to the same shaft.
- Shafts should be connected to at least 1 powertrain component.
- Clutches nodes cannot be connected alone to a same shaft, same for the synchro unit.
- Clutches cannot be in series. Same for synchro units.
- Two clutches cannot be in parallel.
- One clutch and one synchro unit cannot be in parallel.

These constraints verbally explained are numerical relations between the variables  $V_0$  to  $V_{n-1}$ .

This is a constraint satisfaction problem (CSP) and the objective here is to get all the feasible solutions. Constraint programming is used for that. The problem and its constraints are implemented in Python using Python-Constraint module and solvers [9]. The number of possible solutions is very high and different steps of filtering are needed.

### Automatic filtering

The first step of filtering (Redundancy filtering) aims to remove redundant solutions. For this, a description of the mechanical connections in the architectures is done. Similar architectures are dismissed. An example of redundant solution is two similar architectures that differ only by the orientation of the synchro unit.

The second step of filtering is done based on the available modes. For each architecture, the available modes are automatically detected and listed inside what we called ‘Modes Table’ with their number of instances. Considering the available components (Figure 3), nine modes are possible:

- (1) ICE only: ICE alone is connected to the wheels
- (2) Pure 1MG: electric mode, only 1 MG is connected to the wheels
- (3) Pure 2MG: electric mode, 2 MGs connected to the wheels
- (4) Parallel 1MG: ICE and 1 MG connected to the wheels
- (5) Parallel 2MG: ICE and 2 MGs connected to the wheels
- (6) Series: 1 MG is connected to the wheels and the ICE is connected to another MG
- (7) Neutral: the wheels are connected to none of the components, and no connections between the other powertrain components
- (8) Stand-still charging 1MG: the wheels are connected to none of the components; the engine is however connected to 1 MG

- (9) Stand-still charging 2MG: the wheels are connected to none of the components; the engine is however connected to 2 MGs

Constraints are added on the minimum and maximum number of modes required in the architectures. Based on this, some are dismissed.

For each available mode, a description of the paths between all the components is done by calculating:

- The global efficiency of the path
- The global gear ratio of the path

This information is then added inside what we call a ‘Modes Table +’ (Table 1) and will be needed for the architecture’s assessment. In this table, all the available modes are listed and for each of them, the description of the paths between all the components is done. For example, the ICE only mode (1<sup>st</sup> row) is described using two values:  $K_{ICE\_FD}$  and  $\eta_{ICE\_FD}$ .  $K_{ICE\_FD}$  is the global ratio of the ICE to FD path and is calculated as a multiplication of all the ratios of the nodes that exist on this path.  $\eta_{ICE\_FD}$  is the global efficiency of the ICE to FD path and is also calculated as a multiplication of the efficiencies of the nodes on the path. For the other modes, all the paths between the involved components are described in a similar way. Different instances can exist for one mode, for example the architecture can have a second ICE only mode. It will be listed using the same format but different values for  $K_{ICE\_FD}$  and  $\eta_{ICE\_FD}$ . To simulate these 2 instances, the same function in the general hybrid model is called, each time with the proper mode information found in Modes Table +.

	Mode	Description
1	ICE only	$K_{ICE\_FD}, \eta_{ICE\_FD}$
2	Pure 1MG	MG = 1 or 2 $K_{MG\_FD}, \eta_{MG\_FD}$
4	Parallel 1MG	MG = 1 or 2 $K_{ICE\_FD}, \eta_{ICE\_FD}$ $K_{MG\_FD}, \eta_{MG\_FD}$ $K_{ICE\_MG}, \eta_{ICE\_MG}$
5	Parallel 2MG	$K_{ICE\_FD}, \eta_{ICE\_FD}$ $K_{MG1\_FD}, \eta_{MG1\_FD}$ $K_{MG2\_FD}, \eta_{MG2\_FD}$ $K_{ICE\_MG1}, \eta_{ICE\_MG1}$ $K_{ICE\_MG2}, \eta_{ICE\_MG2}$ $K_{MG1\_MG2}, \eta_{MG1\_MG2}$
6	Series	MG = 1 or 2 $K_{MG\_FD}, \eta_{MG\_FD}$ $K_{ICE\_MG}, \eta_{ICE\_MG}$

Table 1: Example of Modes Table +

The information found in Modes Table + will allow each architecture to be assessed using the developed general hybrid model.

### Optimization

The general hybrid model is inserted inside a bi-level optimization process: Genetic Algorithm GA is used on the sizing of components level, while Dynamic Programming DP is used on the control level. This method is commonly used for the optimization of a given architecture model, as presented in [1][3][10]. Unlike these previous works, in our proposed process all the available modes are called instantaneously by DP algorithm. Indeed, the general model is called to generate all required information to the DP process. For each selected architecture, the search area and edge costs are calculated using this general model and the specific information found in Modes Table+. To assess the edge cost, a function is called for each possible mode (and each instance of this mode) and the minimum cost is selected. DP is thus operating with no previous knowledge of the architecture. Changing Modes Table + and repeating the process is enough to simulate and optimize all the generated architectures.

## Comparison

The Pareto fronts of the architectures are finally compared based on the chosen objective functions.

## Case study

The methodology described before is used in this chapter for the generation, filtering, optimization and comparison of series-parallel hybrid architectures.

### Choice of input components

A recent interest is found in the literature in non-power-split series-parallel architectures [11][12]. For instance, the two architectures in Figure 4 were proposed and studied in [2] [13]. They are chosen as reference architectures in this work. We are interested in generating all the architectures that can be realized using their components: 1 ICE, 1 FD, 2 MGs, 4 shafts, 2 clutches and 1 synchro unit of 2 gears.

We assume in this example that the filtered architectures should have at least 1 ICE only, 1 electric, 1 series and 1 parallel modes. In addition, they should allow battery charging at standstill.

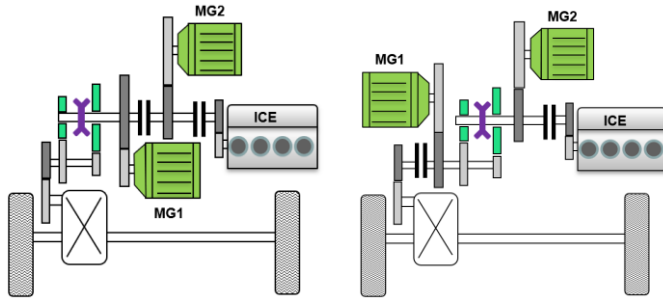

Figure 4: Starting series-parallel architectures

### Automatic generation and filtering

With the input components listed above, the developed tool generates 480 architectures. They are then filtered as explained in the Methodology section. In the redundancy filtering, 417 redundant architectures were detected and removed, 63 architectures are kept. In the modes filtering, the architectures are required to have:

- 1 ICE only mode
- 1 (Pure 1MG or 2MG) electric mode
- 1 Series mode
- 1 Parallel (1MG or 2MG) mode
- 1 Stand-still charging (1MG or 2MG) mode

In this step of modes filtering, 46 architectures are dismissed and 17 remain. The two reference architectures (Figure 4) are two of the 46 dismissed architectures because they do not have an ICE only mode. Nevertheless, they will be considered later for the optimization and comparison with the most promising architectures. A final step of filtering is done regarding the number of paths between the ICE and the wheels. A minimum of two paths is required for dynamic and efficiency reasons. Six architectures failed at this step and 11 are left. They are the most promising architectures according to this filtering.

The 11 most promising and the two reference architectures need to be optimized and compared. Their Modes Tables + are thus passed to the general hybrid model.

### Automatic assessment and comparison

#### a) Component models

For the powertrain assessment and optimization, the vehicle characteristics and components used correspond to a middle class HEV. The road load used is taken from roller test bench values. The ICE is a gasoline engine, Atkinson cycle combustion. MGs are permanent magnet synchronous machines. The re-sized maps are

generated by multiplying the torque and losses by a scaling factor [2]. This scaling method is widely used in HEV predesign optimization [1][2][3]. It can be improved if more accurate models, able to generate maps of different sizes are used. For electric machines, this can be done using reluctance models as in [14]. However, there is a tradeoff between the models' accuracy and the computation time. The works that use accurate models are either doing 1 level optimization (control) or 2 levels optimization (design and control). However, in the 3 levels optimization, having accurate models and sizing methods will make the computation time unfeasible. For this reason, map-based models and simple scaling technique were chosen.

Nickel-metal hydride battery is used (each module: 6.5 Ah capacity, 1kW maximum power) to be able to compare the results to reference vehicles using this battery technology. Lithium-ion technology could also be easily used.

The components gear are parallel axis helical gears. Their ratios are variables in the sizing optimization process. The optimization can choose to remove a gear by setting its value to 1. For this reason, the gear is given an efficiency of 1 in case its ratio is equal to 1 (no gear) and a constant value not equal to 1 (0.98) in case its ratio is different from 1. In that way, if the gear presence is not so important for the powertrain, the optimization will tend to remove it in order to gain this increase in efficiency. The final drive ratio is also a sizing variable, but it is given a 0.97 constant efficiency.

#### b) Design optimization

The model has design variables that the Genetic Algorithm is optimizing. These are:

- |                             |                       |
|-----------------------------|-----------------------|
| o Number of battery modules | o Gear ratio on MG1   |
| o Power of ICE              | o Gear ratio on MG2   |
| o Power of MG1              | o FD gear ratio       |
| o Power of MG2              | o Synchro unit gear 1 |
| o Gear ratio on ICE         | o Synchro unit gear 2 |

Each design candidate should pass a dynamic performance check:

- o Acceleration time from 0 to 100 km/h:  $t_{0 \rightarrow 100} < 10.1$  s
- o Acceleration time from 80 to 120 km/h:  $t_{80 \rightarrow 120} < 7.5$  s
- o Maximum speed of the vehicle on a flat road:  $V_{max} > 180$  km/h

For the objective functions, different choices exist. Ideally, HEV should be an environment friendly solution for mobility. That is why its design should be optimized in order to minimize its overall environmental footprint. For this purpose, an entire Life Cycle Assessment (LCA) should be taken into account. The impact of all phases, namely production, use and recycling phases should be estimated for all the components. However, considering uncertainties on battery recycling or possible reuse of battery in second life applications, only classical mono objective or bi-objectives optimizations have been considered for most research works on HEV design. The most used criterion to minimize has been the fuel consumption (directly related to CO<sub>2</sub> emission) mainly for non-plug-in HEV where fuel is the only source of energy, the battery playing only the role of energy buffer. Some works however considered both fuel consumption and pollutant emissions or battery stress with a search for trade off, but this was only for energy management optimization. From manufacturers' perspectives, other criteria could also be important like the compactness of the powertrain, its weight and more obviously its cost. In theory, the methodology presented here allows the possibility to choose any of these objectives when mathematically expressed in the models and when compatible with the processing time. However, for the sake of simplification, and considering that the case study is a non-plug-in HEV with a charge sustaining optimal strategy, in this article the following 2 objectives are considered:

1. The number of battery modules in series:



The battery size has a direct impact on the powertrain cost, a direct environmental impact and an influence on the LCA. It also allows lower fuel consumption thanks to the ability to recuperate more energy and the more energy freedom when choosing between electric and hybrid modes. A tradeoff is then to be made between the battery size and the fuel savings.

## 2. The fuel consumption

The fuel consumption (FCons) is evaluated in mixed driving conditions. It is computed as a weighted average of the fuel consumption in charge sustaining mode in urban, rural road and highway conditions. The ARTEMIS European driving cycles are used to simulate these three conditions and the control is optimized on each of them using Dynamic Programming.

$$FCons = \alpha.FCons_{urban} + \beta.FCons_{rural} + \gamma.FCons_{highway} \quad (2)$$

Where the  $\alpha$ ,  $\beta$  and  $\gamma$  are coefficients calculated from the mean traveled distance by the French population in urban, rural road and highway conditions. These values are chosen respectively 0.4, 0.3 and 0.3.

The design optimization algorithm is the Genetic Algorithm NSGA-II [15]. In each optimization, the population size is 56 and 400 generations are accomplished. Although being a sizing variable, the number of battery modules is considered here as one of the two objectives in NSGAII. Figure 5 shows the convergence along the two objectives of the Pareto fronts where only dominant solutions are presented.

### c) Control optimization

The global optimal control technique Dynamic Programming (DP) is used to solve the control on each driving cycle in charge sustaining mode. The control variables are the choice of operating mode, the gear selection for a mode and the power split between the components. The initial and final SOC are constraint to be 60%. The minimum SOC limit is chosen to be 20% and the maximum SOC limit set to 70%. A SOC discretization step of 0.05% and a time step of 1 second are used.

### d) Results

The Modes Table + of the 13 selected architectures (11 filtered + two references) are passed automatically to the General Hybrid Model and are optimized. This will lead to a Pareto front for each architecture, showing the trade-off between the two objective functions, namely the battery size and the fuel consumption (Figure 5).

This outcome shows that the methodology systematically:

- Generated all the feasible architectures, including the two reference architectures previously proposed.
- Filtered the generated architectures and selected the most promising for evaluation and optimization. The selected architectures seem to be quite efficient, most of them have fuel consumptions close to the references (maximum 6% higher FCons, except for architecture 2)
- Found several architectures better than the references (architecture 7 having a fuel consumption about 5% lower than the references for the same number of batteries).

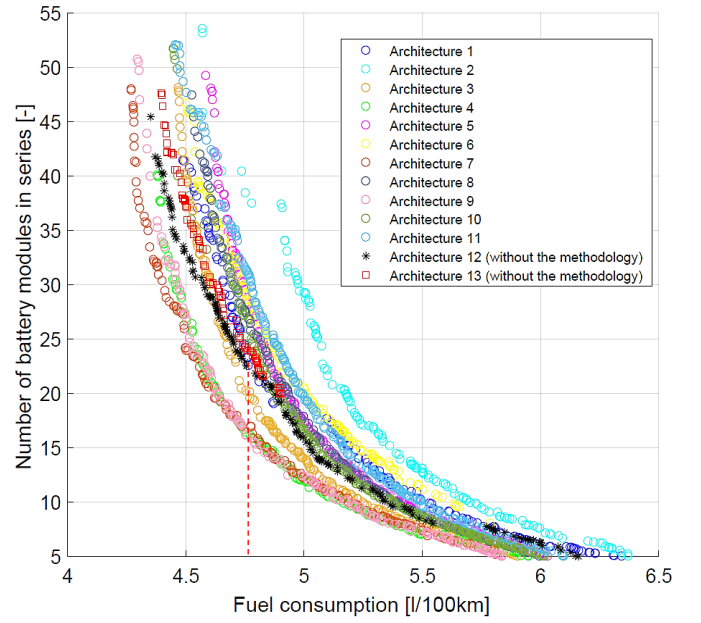

Figure 5: The Pareto fronts

### Optimal Sizing

A closer look is made on the optimal sizing of the Pareto points corresponding to a fuel consumption of 4.7 l/100km (red dashed line in Figure 5) which is chosen as an example. The sizing results are shown in Figure 6.

The ratios in red correspond to gear ratios chosen by the optimization to be close to 1. This means that these gears are to be removed from the architecture. When comparing the powertrain components sizing (lines in blue), a downsizing of the ICE is detected for the three selected architectures when compared to the references. In order to evaluate the downsizing of the entire powertrain, an index called powertrain (PWT) cost index is created. It is the cost of the powertrain, calculated as follows:

$$PWT \text{ cost index} = \text{Cost Battery } f(kWh) + \text{Cost MG and converters } f(kW) + \text{Cost ICE } f(kW, N.m) \quad (3)$$

These costs could be different according to manufacturer and technology.

For typical costs values and a same fuel consumption of 4.7l/100km, the three selected architectures present a 5% to 6.7% reduction in PWT cost. Architecture 4 is the best in terms of PWT cost and simplicity since three gear ratios were removed (in red).

Architectures	Most promising			Reference	
	7	9	4	12	13
FC mixed [l/100km]	4.7	4.7	4.7	4.7	4.7
Nb battery blocs	18	18	18	25	27
MG1	78	91	94	65	56
MG2	79	99	99	51	26
ICE	82	77	74	89	90
FD	2.55	2.99	3.57	3.81	3.62
K_ice	0.99	1.00	0.99	1.16	1.71
K_mg1	1.05	1.02	0.99	1.55	1.06
K_mg2	2.95	1.26	1.02	1.13	2.15
S_L	1.07	1.49	1.25	1.95	2.18
S_R	0.54	0.65	0.61	0.91	1.11
PWT cost index [-]	2.85	2.83	2.8	3.00	3.00

- 6.7% in cost

Figure 6: The optimal sizing

## Novel architecture

The results presented in the previous chapter show that architecture 7 has a good potential in terms of fuel consumption and cost reduction. It will be clearly revealed and studied in this chapter.

A diagram describing this architecture is shown in Figure 7. Unlike what is seen in conventional gearboxes (Figure 4), the two gears of the synchro unit are not connected to a same shaft. In addition, fewer gears are used.

Such set-up is not trivial to the mind of architecture design engineers. This architecture was generated by the developed tool and probably would have not been thought of in the absence of this tool.

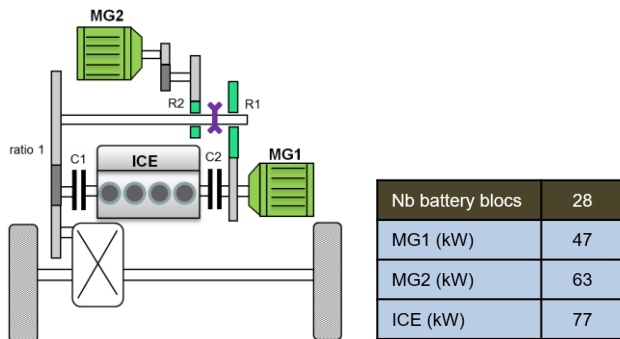

Figure 7: Architecture 7 and the considered components sizing

The optimal sizing point corresponding to 28 battery modules is shown in Figure 7, right. It will be considered for powertrain operation analysis.

The powertrain operation is first analyzed on the driving cycles used for the calculation of the fuel consumption. The speed and state variable (SOC) profiles during urban driving are shown in Figure 8. The max charging and discharging limits are shown in green and red. The optimal SOC variation in magenta. It is clear how the powertrain is operating in charge sustaining mode and finished the driving cycle with a final SOC equal to the initial SOC. The choice of modes is shown in Figure 9 as percentage of usage time. In the urban driving, the electric 1MG mode seems dominant (57% of the time), the parallel 1MG less used, and the series mode only 1% of the time used.

The same analysis is done in rural and highway driving (Figure 9). The series mode is marginally or never used. The parallel modes are more and more used.

The minor usage of the series mode is remarkable and its necessity seems questionable in urban, rural and highway driving. For this reason, a closer look was made on the dynamic performance test.

Here it was detected that the series mode was used in the maximum performance test. To determine whether this mode was irreplaceable, the performance test was repeated while forcing the series mode to be inhibited. The performance values are presented:

- o  $t_0 \rightarrow 100 < 10.1s$ : 9.873s in presence of series  
10.64s in absence of series
- o  $t_{80} \rightarrow 120 < 7.5s$ : 7.330s in presence of series  
7.503s in absence of series
- o  $V_{max} > 180 km/h$ : 198 km/h in presence of series  
197 km/h in absence of series

The acceleration requirements were not met (in red) and the powertrain failed the performance test. The presence of the series mode is therefore essential if we have to respect closely the dynamic specifications.

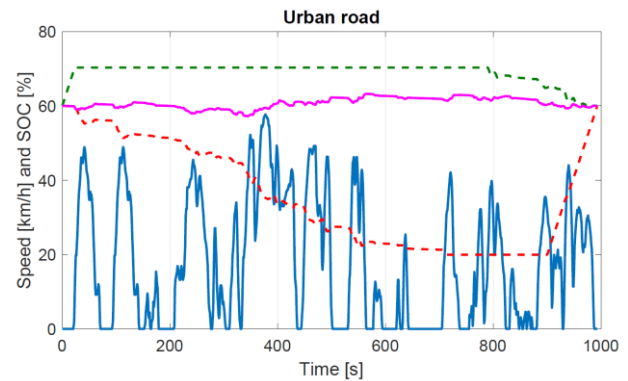

Figure 8: Speed and state variable profiles during urban driving

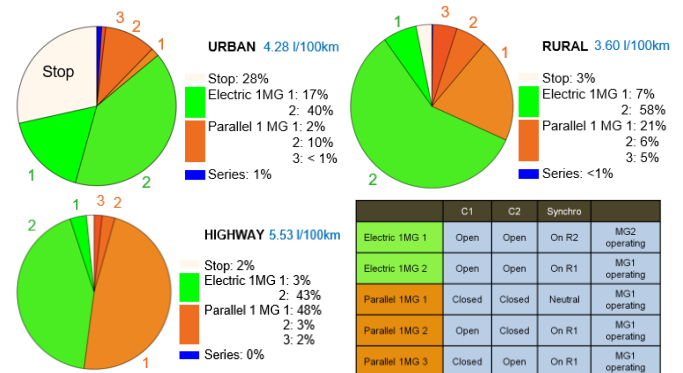

Figure 9: Modes choice in urban, rural and highway driving, in % of time

## Conclusion

The comparison between hybrid vehicle architectures is used to be done in a non-systematic way involving the manual design and modeling of the imaginable architectures. However, this kind of approach is time consuming and does not explore all the possible solutions. The present article proposes a methodology that performs comparison between HEVs in an automatic and exhaustive way. The components of series-parallel architectures (taken as example, excluding planetary gears) were first chosen as design input. An automatic generation of all the realizable architectures was then done. An automatic filtering allowed the selection of the most promising ones. Automatic optimization and comparison were then performed using a generic hybrid model associated to a genetic algorithm and to a dynamic programming based control. The results show that the

automation allowed the discovery of architectures with up to 5% gain in fuel consumption and about 7% gain in cost. The best architecture is clearly revealed and studied. Among the finding is that the control selects seldom the series mode during driving cycles. This mode is however necessary for the vehicle to achieve required dynamic performance. In the future, this work will be repeated with different choices of input components (including planetary gears), and while considering more powertrain aspects (compactness, weight, cost, aging, pollutants emissions). The final aim is to create a database that can help in choosing the future hybrid architectures without the need for simulation.

## References

- [1] E. Silvas, E. Bergshoeff, T. Hofman, and M. Steinbuch, "Comparison of Bi-level Optimization Frameworks for Sizing and Control of a Hybrid Electric Vehicle," *Veh. Power Propuls. Conf. (VPPC), 2014 IEEE*, pp. 0–5, Oct. 2014, doi: 10.1109/VPPC.2014.7007029.
- [2] B. Kabalan, E. Vinot, Y. Cheng, R. Trigui, C. Dumand, and T. El Hajji, "Efficiency Improvement of a Series-Parallel Hybrid Electric Powertrain by Topology Modification," *IEEE Trans. Veh. Technol.*, pp. 1–1, 2019, doi: 10.1109/TVT.2019.2952190.
- [3] T. Hofman, S. Ebbesen, and L. Guzzella, "Topology Optimization for Hybrid Electric Vehicles With Automated Transmissions," *IEEE Trans. Veh. Technol.*, vol. 61, no. 6, pp. 2442–2451, 2012, doi: 10.1109/TVT.2012.2196299.
- [4] X. Zhang, C.-T. Li, D. Kum, and H. Peng, "Prius(+) and Volt(-): Configuration Analysis of Power-Split Hybrid Vehicles With a Single Planetary Gear," *IEEE Trans. Veh. Technol.*, vol. 61, no. 8, pp. 3544–3552, 2012, doi: 10.1109/TVT.2012.2208210.
- [5] K. Chen, A. Bouscayrol, A. Berthon, P. Delarue, D. Hissel, and R. Trigui, "Global modeling of different vehicles," *Veh. Technol. Mag. IEEE*, vol. 4, no. 2, pp. 80–89, 2009.
- [6] X. Zhang, S. E. Li, H. Peng, and J. Sun, "Design of Multimode Power-Split Hybrid Vehicles - A Case Study on the Voltac Powertrain System," *IEEE Trans. Veh. Technol.*, vol. 65, no. 6, pp. 4790–4801, 2016, doi: 10.1109/TVT.2016.2531740.
- [7] E. Silvas, T. Hofman, A. Serebrenik, and M. Steinbuch, "Functional and Cost-Based Automatic Generator for Hybrid Vehicles Topologies," *IEEE/ASME Trans. Mechatronics*, vol. 20, no. 4, pp. 1561–1572, 2015, doi: 10.1109/TMECH.2015.2405473.
- [8] J. Wijkniet and T. Hofman, "Modified Computational Design Synthesis Using Simulation-Based Evaluation and Constraint Consistency for Vehicle Powertrain Systems," *IEEE Trans. Veh. Technol.*, vol. 67, no. 9, pp. 8065–8076, 2018, doi: 10.1109/TVT.2018.2844024.
- [9] G. Niemeyer, "Python-Constraint," *Constraint Solving Problem resolver for Python*. <https://labix.org/python-constraint>.
- [10] H. Guo, Q. Sun, C. Wang, Q. Wang, and S. Lu, "A systematic design and optimization method of transmission system and power management for a plug-in hybrid electric vehicle," *Energy*, vol. 148, pp. 1006–1017, Apr. 2018, doi: 10.1016/j.energy.2018.01.152.
- [11] M. Nakagawa, U. Schwarz, and J. Andert, "DENSO 's Contribution for the Future E-mobility Through New Technology ( Innovative approach for development )," 2013.
- [12] N. Fremau, A. Villeneuve, A. Ketfi-Cherif, and A. Vignon, "Hybrid transmission with offset electric machine and method for controlling gear changes," WO2015197927A1, 2015.
- [13] S. Washino, T. Saito, and Y. Jia, "New 3 Mode Hybrid System Concept," *24th Aachen Colloq. Automob. Engine Technol. 2015*, pp. 1123–1139, 2015.
- [14] M. Le Guyadec, L. Gerbaud, E. Vinot, and B. Delinchant, "Sensitivity analysis using Sobol indices for the thermal modelling of an electrical machine for sizing by optimization," *COMPEL - Int. J. Comput. Math. Electr. Electron. Eng.*, vol. 38, pp. 965–976, 2019, doi: 10.1108/COMPEL-09-2018-0360.
- [15] K. Deb, A. Pratap, S. Agarwal, and T. Meyarivan, "A Fast and Elitist Multiobjective Genetic Algorithm : NSGA-II," *IEEE Trans. Evol. Comput.*, vol. 6, no. 2, pp. 182–197, 2002, doi: 10.1109/4235.996017.



**Bilal Kabalan** received his B.E. in Mechanical Engineering from the Lebanese American University, Lebanon in 2015. He received a M.S. in Powertrain Engineering from IFP School, France in 2017.

In March 2020 he finished a PhD that took place in the Advanced Research Department of Groupe PSA and in IFSTTAR. He then joined IFSTTAR as a researcher. His work is focused on developing optimal methodologies for the design of hybrid electric vehicle powertrains.



**Emmanuel Vinot**, aged 48, received the engineering degree from the Grenoble-INP Institute (1997), the M.S. degree in electrical engineering from the Laval University, Québec, Canada (1998) and the Ph. D degree from the Grenoble-INP Institute in 2000. Currently he is working in Gustave Eiffel University in ECO7 (ECO-gestion des Systèmes Énergétiques Pour les Transports) team. His main interests are systemic model of vehicle and components, system management optimisation, and system and electrical machine design.



**Rochdi Trigui** received the PhD in Electrical Engineering in 1997. Since 1998, he has been full researcher (senior since 2012) in the French Institute of Science and Technology for Transport, Development and Networks (IFSTTAR) in the field of modelling and energy management of electric and hybrid vehicles. He is now deputy head of AME department of Gustave Eiffel University (former IFSTTAR).

He is member of the French MEGEVH network. He was co-chair of IEEE VPPC 2010.



**Clément Dumand** received his Engineering degree of Polytech'Orléans (2002) and the PhD degree from ENSMA of Poitiers, France, in 2005.

Currently, he is team leader in the Advanced Research Department of Groupe PSA. His team is in charge of advanced research in powertrain, new energy converter and energy storage technologies, new energy pathways and advanced Computer Aided

Design using Artificial Intelligence and automatic optimization.