



HAL
open science

”Three-Dimensional Printing of Synthesized Eight Link Gear Variable Topology Mechanism with Fused Deposition Modeling Technique”

Mr H M Naveen, Shrinivas S Balli, Umesh M Daivagna

► To cite this version:

Mr H M Naveen, Shrinivas S Balli, Umesh M Daivagna. ”Three-Dimensional Printing of Synthesized Eight Link Gear Variable Topology Mechanism with Fused Deposition Modeling Technique”. Journal of Scholastic Engineering Science and Management, 2021. hal-03328077

HAL Id: hal-03328077

<https://hal.science/hal-03328077v1>

Submitted on 28 Aug 2021

HAL is a multi-disciplinary open access archive for the deposit and dissemination of scientific research documents, whether they are published or not. The documents may come from teaching and research institutions in France or abroad, or from public or private research centers.

L’archive ouverte pluridisciplinaire **HAL**, est destinée au dépôt et à la diffusion de documents scientifiques de niveau recherche, publiés ou non, émanant des établissements d’enseignement et de recherche français ou étrangers, des laboratoires publics ou privés.



Distributed under a Creative Commons Attribution - NonCommercial - NoDerivatives 4.0 International License



JSESM

Journal of Scholastic Engineering Science and Management

Aug 2021, Volume 1, Issue 4, pp:1-15

“Three-Dimensional Printing of Synthesized Eight Link Gear Variable Topology Mechanism with Fused Deposition Modeling Technique”

¹Mr.H. M. Naveen, ²Dr.Shrinivas S. Balli, ³Dr. Umesh M. Daivagna

¹Assistant Professor, ²Professor, ³Professor

^{1,2,3}Department of Mechanical Engineering

¹RYM Engineering College, Ballari, Karnataka, India, ²Basaveshwar Engineering College, Bagalkot, Karnataka, India, ³Ballari Institute of Technology, Ballari, Karnataka, India



Email: kasinathnaveen@gmail.com, shrinivassballi@gmail.com, daivagnaum@gmail.com

ABSTRACT

The paper demonstrates three-dimensional (3D) printing of synthesized mechanism with the aid of fused deposition modeling technique (FDM). The mechanism taken into consideration is eight link gear variable topology mechanism having two degrees of freedom. The over view of synthesized mechanism is dealt with and the determined parameters are considered for printing of the mechanism. Various 3D printing techniques are available and the paper focuses on FDM which appears to the part of additive manufacturing. This process creates an insight to the practical observation of mechanism behavior before proceeding to fabrication.

Keywords: Variable Topology Mechanism, Fused Deposition Modeling, Eight Link Gear

1. INTRODUCTION

Additive manufacturing is one of the mile stone in the industrial sector which offers different methods to manufacture a component which is designed as per the requirement of design engineers. This is the technological development obtained by the conversion from analog to digital processing of the given parameters. The parameters observed in the case of mechanisms will the link lengths. The link lengths provided in solid edge software are utilized to create the model of the mechanism and the same parameters are fed to the 3D printer for material deposition in precise shape and geometry to manufacture the mechanism layer wise. This is one of the processes where in the material is going to be added rather than removed from the parent material. The digital revolutions in imaging and scanning have brought the additive manufacturing to its flexibility and accuracy. The concept behind this manufacturing technique is that the mechanism links are develop in 3D, basically in x, y and z directions layer by layer through successive bonding. The machine used to develop such links is addressed to be a 3D Printer. The command given by solid edge software regarding link parameters are provided to the printer which in turn melts the solid material to a predefined temperature. This melted material is guided through the nozzle to deposit on the heated plate. As cooling of the material takes place links will be formed. This provides additive manufacturing to find its way on numerous applications like development of mechanisms.

2. LITERATURE REVIEW

This paragraph provides research work carried out on variable topology mechanisms. Shrinivas S. Balli and Satish Chand [1] informed an analytical method that can be used to synthesize five bar mechanisms with variable topology. Shrinivas S. Balli and Satish Chand [2] proposed the complex number method to synthesize the mechanism having five links for motion and path generation tasks with variable topology for movement between extreme positions. Shrinivas S. Balli and Satish Chand [3] suggested an analytical method to synthesize planar seven link mechanism with variable topology for motion between two dead centers. Gadad, Umesh M. Daivagna and Shrinivas S. Balli [4] focused on planar seven link mechanism using triad and dyad with variable topology for the task function generation. Umesh M. Daivagna and Shrinivas S. Balli [5] dealt with synthesis process of an off-set five link slider mechanism with variable



topology. Ren-Chung Soong, Kuei-Shu Hsu and Feng-Tsai Weng [6] applied a geared seven-bar mechanism for mechanical forming presses. Umesh M. Daivagna and Shrinivas S. Balli [7] synthesized a variable topology seven-bar slider mechanism to have motion between two dead-center positions. Volken, Eres Soylemez and Engin Tanik [8] presented an analysis and synthesis method for a geared four-bar mechanism. Umesh M. Daivagna and Shrinivas S. Balli [9] worked on the synthesis of variable topology mechanism with five-bar slider for finitely separated positions. Prashant B. Tadalagi and Shrinivas S. Balli [10] reviewed the works on variable topology method. H. M. Naveen, Shrinivas S. Balli and Umesh M. Daivagna [11] dealt with synthesis of eight link gear mechanism for motion generation. H. M. Naveen, Shrinivas S. Balli and Umesh M. Daivagna [12] dealt with synthesis of In-Line Ten Link Gear Slider Mechanism of Variable Topology. Prashant B. Tadalagi and Shrinivas S. Balli [13] synthesized a seven-bar slider for limiting positions using variable topology. Prashant B. Tadalagi and Shrinivas S. Balli [14] synthesized seven bar sliders for dead center positions using variable topology method. Shivamanappa G.Desai Anandkumar R. Annigeri and A. TimmanaGouda [16] presented the analysis of eight link walking mechanism.

3. VARIABLE TOPOLOGY MECHANISM

The process of variable topology method is to simplify the process of synthesis by reducing two degrees of freedom eight link gear mechanism into a single degree of freedom seven link gear mechanism in two phases. The mechanism may be designed to carry out different task in different phases. Complex number method, one of the analytical synthesis techniques is presented as an ideal tool for modeling linkages with groups of standard form of equations for motion, path and function generation ^[15]. Hence the method of variable topology using complex number draws the attention of design engineers. The synthesized eight link gear mechanism will be produced in 3D printer by using fused deposition modeling technique accompanied with study using Solid Edge and Linkage software.

3.1. Working Principle of Eight Link Gear Variable Topology Mechanism

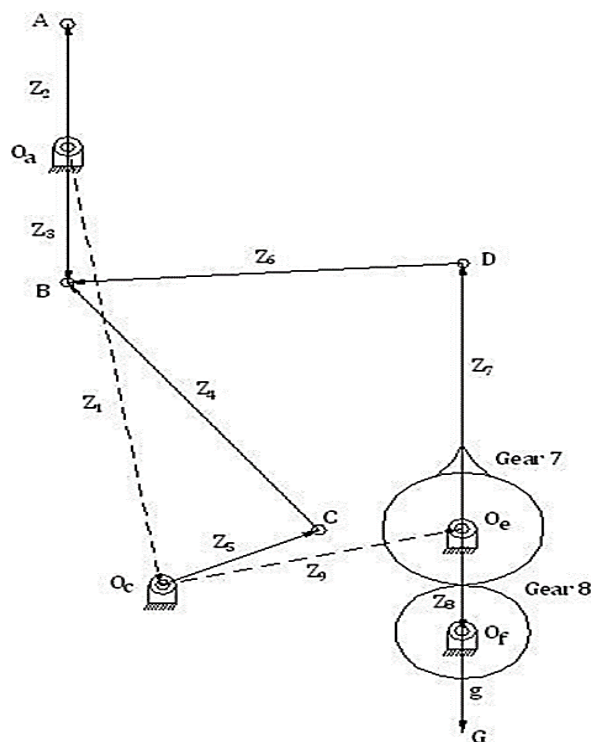

Fig.1.0: Schematic Representation of Eight Link Gear Variable Topology Mechanism

The eight-link gear variable topology mechanism is presented figure.1.0. Mechanism consists of links O_aA and O_cC working as input links. The permanently fixed ground link is O_aO_c . These input links are attached to links AB and CB which in turn are attached to link DB which acts as couplers of the considered mechanism. The coupler DB is attached to gear 7 at point D which is an extension of gear 7 paired to gear 8. The extension O_eD is fixed on to gear 7 and oscillates along with it. The gear pair is mounted by a rigid link O_eO_f . Both the gears rotate on end pivot points of the rigid link. O_eO_f are said to be the axes of rotation for the pair of gears. When motion is given to any of the input link with the predefined condition of fixing the link temporarily in Phases, the obtained motion is transferred to the through links AB CB and DB to the link O_eD which will oscillates according to the desired input motion provided. The vector g (O_fG) represents the rotation of gear 8. With variable topology method this mechanism can be made to work in different Phases to carry out different tasks. This can be achieved by making one of the input links to be “active” and another input link to be stationary or temporarily fixed.

3.1.1. Eight Link Gear Variable Topology Mechanism in Phase I Operation

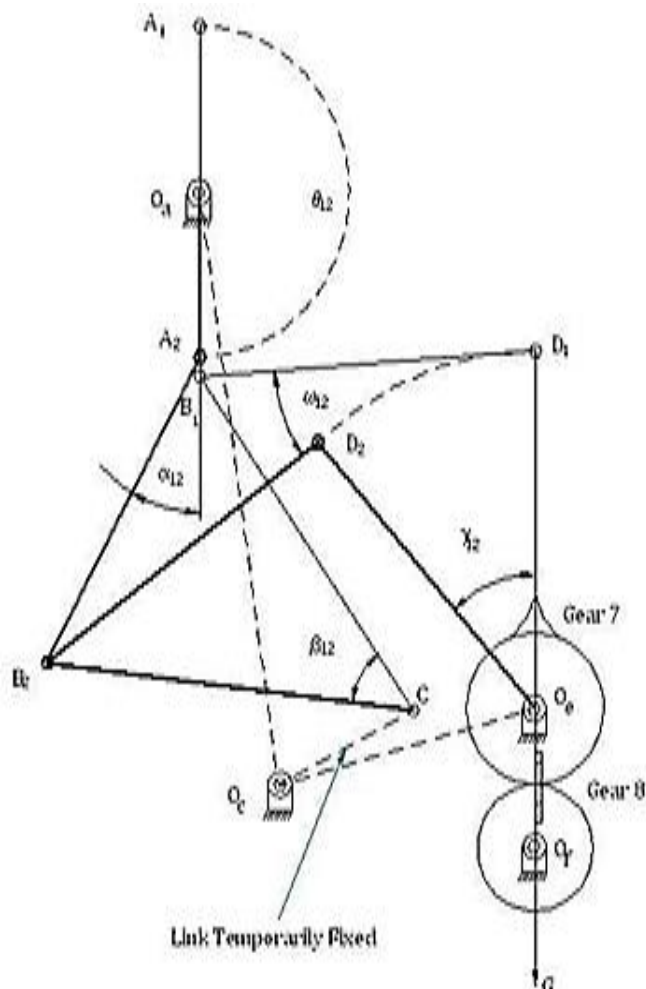

Fig.1.1: Schematic Representation of Eight Link Gear Variable Topology Mechanism Phase I Operation

The Phase I operation of the mechanism involves fixing of link O_cC temporarily and thus rest of the mechanism operates for a given input motion. In this Phase of operation, the crank O_1A_1 is made to move from 0° to 180° as shown in figure. 1.1. These two reference angles are treated as starting and ending position of the mechanism operating in this Phase.



3.1.2. Eight Link Gear Variable Topology Mechanism in Phase II Operation

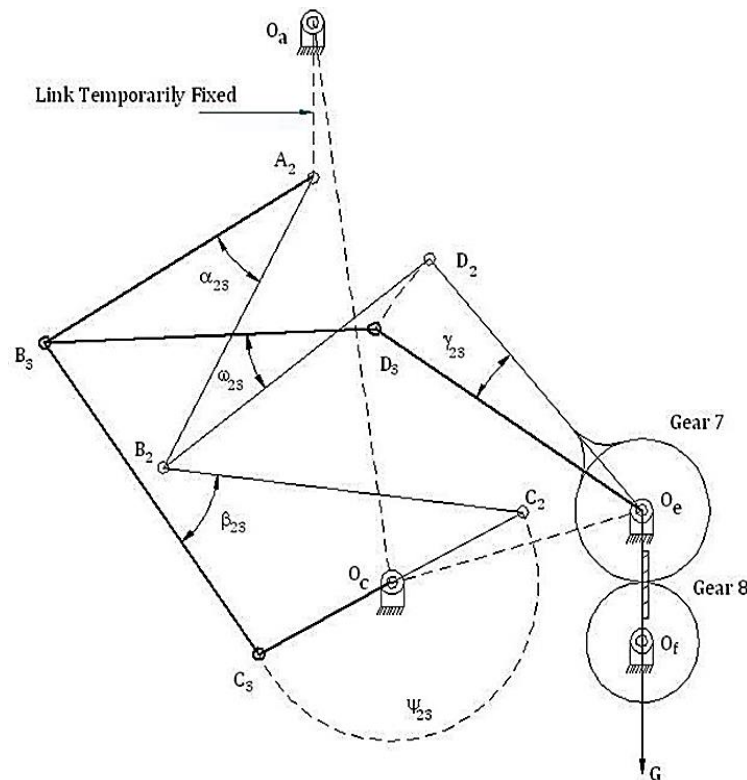

Fig.1.2: Schematic Representation of Eight Link Gear Variable Topology Mechanism Phase II Operation

The Phase II operation of the mechanism involves fixing of link OaA temporarily and thus rest of the mechanism operates for a given input motion. In this Phase of operation, the crank OcC is made to move from 00 to 1800 as shown in Figure.1.2. These two references angles are treated as starting and ending position of the mechanism operating in this Phase.

The further paragraphs explain how the synthesized mechanism is printed practically and the working aspect which was dealt in earlier paragraphs can be visualized with the physical model in hand. The process utilized in manufacturing the links of the mechanism is also dealt with. The mechanism is also designed in Solid Edge software with which the input files for the 3D printer are adopted. Addition to the present work motion tracer paths of reference points on links working in respective Phases are also developed using the Linkage software.

3.1.3. Implementation Of 3d Print Technology for Development of Eight Link Gear Variable Topology Mechanism

The techniques in 3D printing process can be categorized as represented in

Figure 1.3

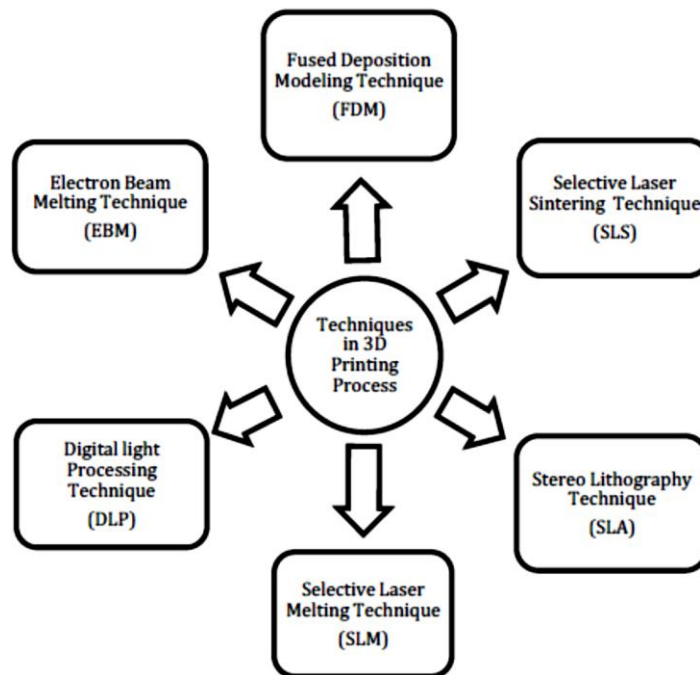

Fig.1.3: Schematic Representation of Techniques in 3D Printing Technology

The 3D printing technique implemented in this paper is the part of numerous printing techniques represented in Figure 1.4. This technique is pretended to be an additive manufacturing process where in the material is going to be added to the parent material rather than removing from the same. Fused deposition modeling technique utilizes solid state of input material accompanied with heating and depositing on the given plate. This deposition of the molten material is based on the geometry provided to the computer. In the present case the technique is implemented to develop links of the eight-link gear mechanism to study the functional aspects. The process starts with development of links in Solid Edge software and then providing those inputs to the computer which is connected to the printer.

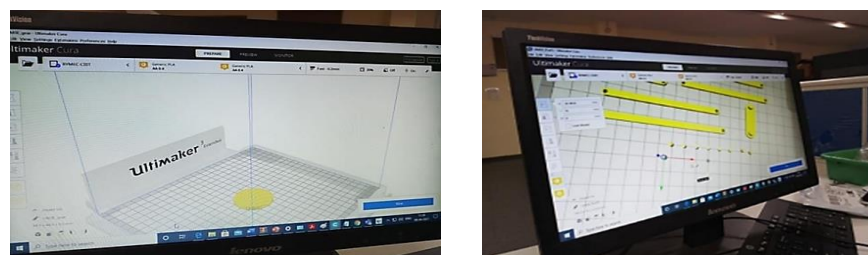

Fig.1.4: Schematic Representation 3D Printing Process and Computer Interface



Once this data is provided to the computer, an interface supporting the printer has to be installed in the computer through which the printing process gets initiated. This requires a set of predetermined conditions to be set before starting the printing process. This includes proper alignment of links on the board, temperature of the board, rate of feed of the material and type of material to be manufactured. These conditions must be fulfilled by an expert who has prior experience in the related field. Finally, the command is given to the printer to start the process. This process is represented in Figure 1.5.

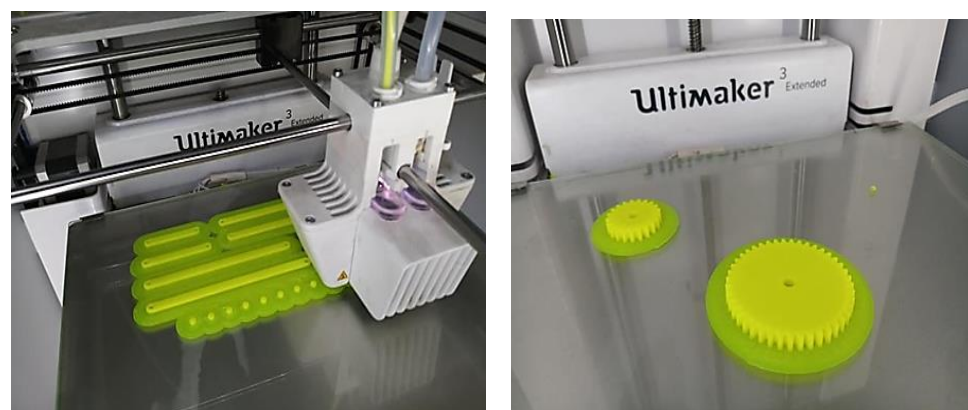

Fig.1.5: Schematic Representation 3D Printing Process

Printing process requires a continuous monitor as certain hindrances may occur during the process. This printing process is illustrated in Figure 1.5. The printed links of the mechanism are then removed from the plate and are processed for removing of any extra material and finishing process. The process involves cleaning of link holes, gear teeth, check of gear pair meshing and connecting of joints between two links. Further process involves assembling of all the linkages on the ground in the synthesized manner. Care must be taken while assembling of linkages as orientation and positions of links are not mismatched which hinders the functioning of the mechanism. To avoid such situations proper naming of links must be done as it is done in this case. Further paragraphs explain working condition of the assembled mechanism.



3.1.4.3D Print Model of Eight Link Gear Variable Topology Mechanism in Phase I Operation

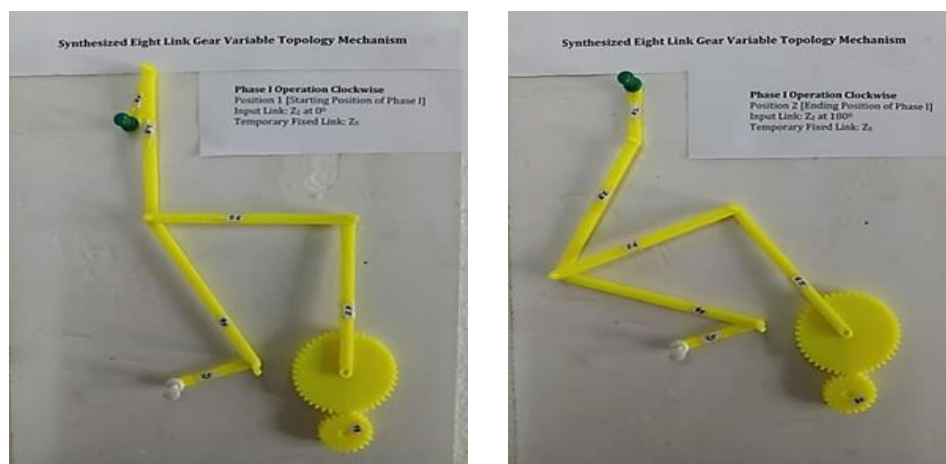

Fig.1.6: Schematic Representation of Eight Link Gear Variable Topology Mechanism 3D Print Model in Phase I Operation showing Position 1 and Position 2

The printed links of eight link gear variable topology mechanism are assembled on the ground to function the mechanism. The linkages are mounted on a board and ground reference pivot points are fixed. In the present scenario joints O_a , O_c , O_e and o_f are fixed to the ground and rotary motion is permitted. As per the predefined working condition of Phase I, link O_cC is also fixed to the ground but temporarily and input motion is given to link O_aA . With the set condition mechanism is made to work which is depicted in Figure 1.6 This shows the working of mechanism in Phase I operating condition moving from Position 1 to Position 2 which are treated as starting and ending positions of the Phase I. This completes motion of the mechanism in Phase I as per the design requirement. Motion of mechanism in this Phase can be utilized for some applications which involve pick and place.

3.1.5.D Print Model of Eight Link Gear Variable Topology Mechanism in Phase II Operation

Phase II operating condition also involves the same scenario of joints O_a , O_c , O_e and o_f to be fixed to the ground and rotary motion is permitted. As per the predefined working condition of Phase II, link O_aA is also fixed to the ground but temporarily in a new position and input motion is given to link O_cC . The link O_cC



which was fixed temporarily in Phase I will be released to move in Phase II which happens to be the continuity of motion to the complete mechanism.

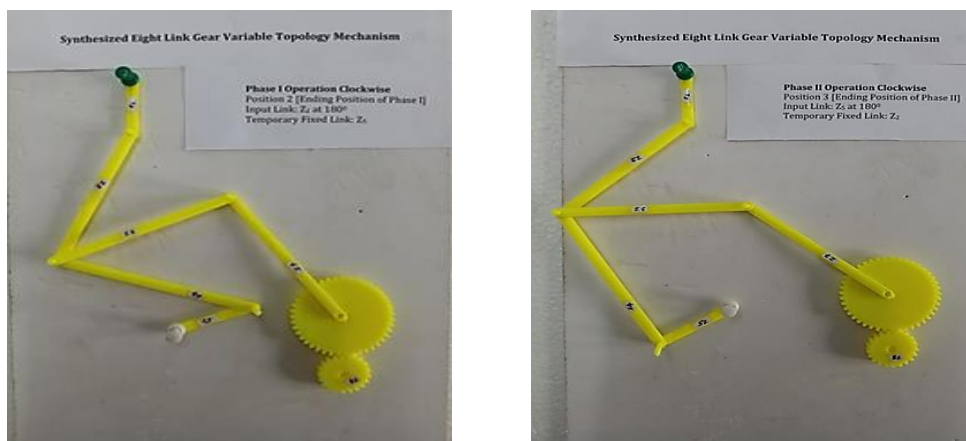

Fig.1.7: Schematic Representation of Eight Link Gear Variable Topology Mechanism 3D Print Model in Phase II Operation showing Position 2 and Position 3

With the set condition mechanism is made to work which is depicted in Figure.1.7. This shows the working of mechanism in Phase II operating condition moving from Position 2 to Position 3 which is treated as starting and ending positions of the Phase II. This completes motion of the mechanism in Phase II as per the design requirement. Motion of mechanism in this Phase can be utilized for some applications as per the choice of the design engineer.

3.1.6. Complete Working of 3D Print Model of Eight Link Gear Variable Topology Mechanism

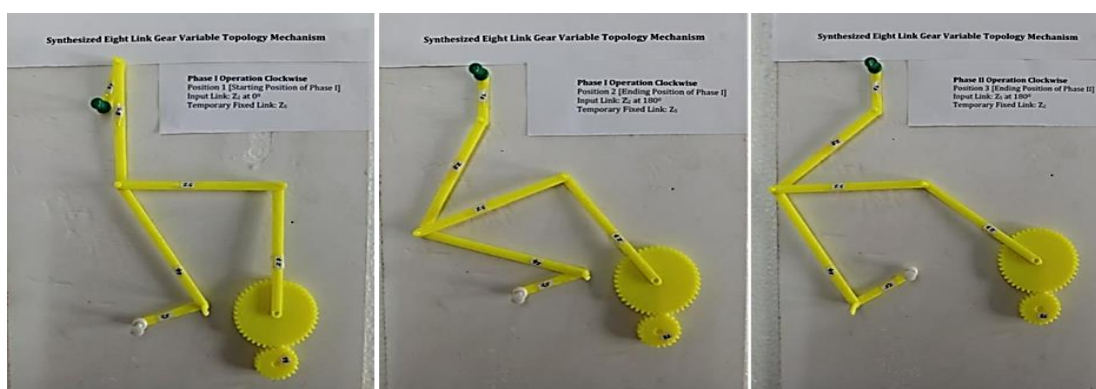

Fig.1.8: Schematic Representation of Complete Working of Eight Link Gear Variable Topology Mechanism 3D Print Model in Phase I and Phase II Operation showing Position 1, Position 2 and Position 3



The complete working of eight link gear variable topology mechanism can be visualized in Figure 1.8. This involves movement of the mechanism from Phase I to Phase II through the Positions 1, 2 and 3. Hence the working of mechanism in two different Phases can be utilized for number of applications. The overview of mechanism working condition is represented in Table 1.

Table 1: Complete Working of Eight Link Gear Variable Topology Mechanism

	Input Link	Output Link	Temporary Fixed Link	Starting Position	Ending Position
Phase I	O _a A	Gear 8	O _c C	Position 1	Position 2
Phase II	O _c C	Gear 8	O _a A	Position 2	Position 3

4. STUDY OF EIGHT LINK GEAR VARIABLE TOPOLOGY MECHANISM THROUGH VARIOUS ASPECTS

The synthesized eight link gear variable topology mechanism is studied through various aspects in engineering sector. This involves designing of mechanism in Solid Edge Software to visualize the practical approach of the mechanism and study the working condition in Linkage Software. Further paragraphs deal with the concept of designing and study of working condition of synthesized eight link gear variable topology mechanism.

4.1.Solid Edge Model of Eight Link Gear Variable Topology Mechanism

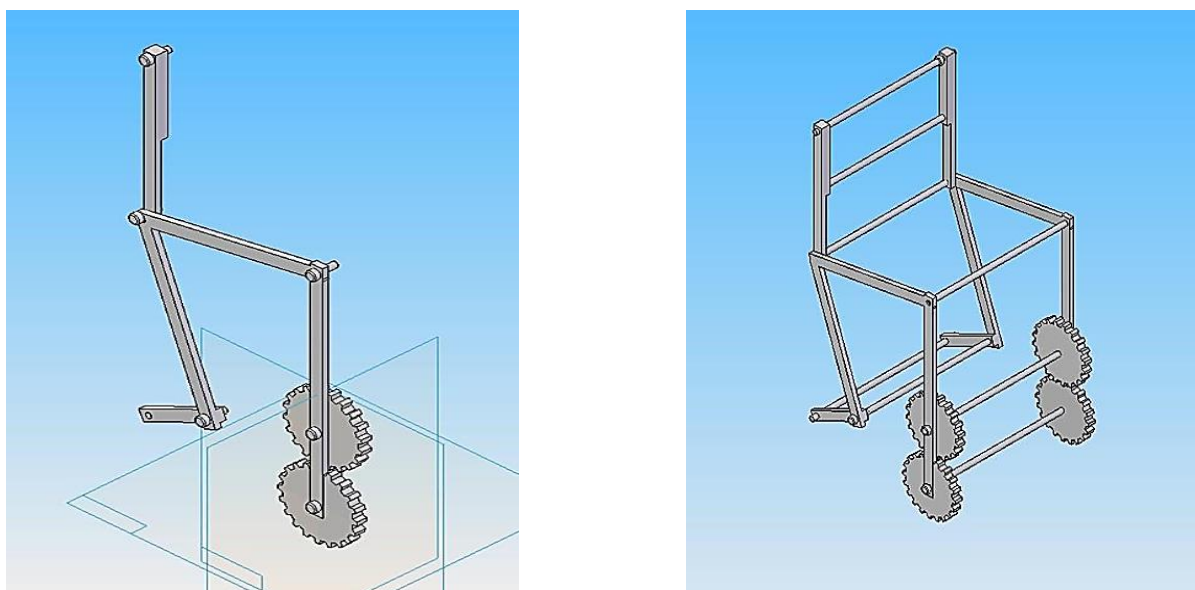

Fig.1.9: Schematic Representation of Eight Link Gear Variable Topology Mechanism in Solid Edge Model

Synthesized eight link gear variable topology mechanism is designed in Solid Edge Software and is represented in Figure 1.9. The mechanism is designed in a given plane and in addition the initial reference plane another parallel plane is added which provides the parallel mechanism concept. This opportunity provided to the mechanism shows that two parallel mechanisms can be made to work using a single input given at initial reference plane. This is not limited to only two planes and can be extended to more planes as per the choice of designer and given application.

4.2.Eight Link Gear Variable Topology Mechanism in Linkage Software

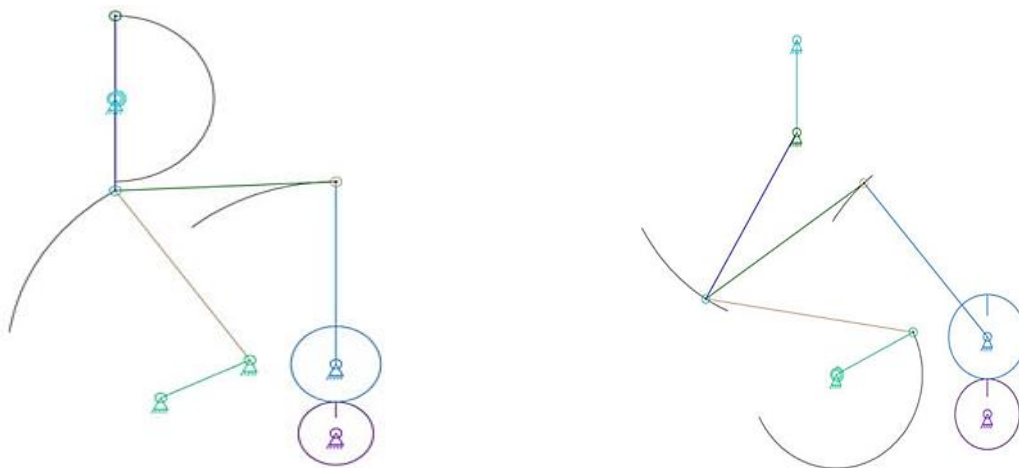

Fig.1.10: Schematic Representation of Eight Link Gear Variable Topology Mechanism in Linkage Software Phase I and Phase II

The synthesized eight link gear variable topology mechanism is designed in Linkage Software and is represented in Figure 1.10. The designed mechanism is provided with the input motion to study the working aspect of the mechanism. The paths traced by the reference point clearly depict the satisfactory working condition of the mechanism in respective Phases. Linkage Software provides an easy access and flexible nature of approach. The program is freely available at DAVE'S BLOG which is developed by David M. Rector [17]. This is a computer aided design program used for modeling of mechanisms. This is one of the simplest CAD programs which offers quick analysis and modifications while working on the design.

CONCLUSIONS

The development and study of synthesized eight link gear variable topology mechanism presented in the context shows any mechanism can be taken into the consideration for the validation of the obtained parameters. The 3D mechanism printing concept provides an insight to handle practical behavior of the mechanism before the fabrication of the real model happens. The authors have demonstrated various study aspects in the field of mechanisms which opens up different ways of understanding the working condition of the mechanism. An approach is given to build the platform between analytical and practical study of mechanism with implementation of 3D Printing Technology in the field of research.

REFERENCES

- [1]. Shrinivas S. Balli and Satish Chand, “Synthesis of a five-bar mechanism with variable topology for motion between extreme positions (SYNFBVTM),” *Mechanism and Machine Theory*, vol. 36, no.10, pp. 1147–1156, 2001.
- [2]. Shrinivas S. Balli and Satish Chand, “Five-bar motion and path generators with variable topology for motion between extreme positions,” *Mechanism and Machine Theory*, vol. 37, no. 11, pp. 1435–1445, 2002.
- [3]. Shrinivas S. Balli and Satish Chand, “Synthesis of a planar seven-link mechanism with variable topology for motion between two dead-center positions,” *Mechanism and Machine Theory*, vol.38, no. 11, pp. 1271–1287, 2003.
- [4]. G. M. Gadad, Umesh M. Daivagna and Shrinivas S. Balli, “Triad and dyad synthesis of planar seven-link mechanisms with variable topology”, *National Conference on Machines and Mechanisms (NaCoMM '05)*, pp. 67–73, 2005.
- [5]. Umesh M. Daivagna and Shrinivas S. Balli, “FSP Synthesis of an off-set five bar-slider mechanisms with variable topology”, *National Conference on Machines and Mechanisms (NaCoMM '07)*, pp. 345–350, 2007.
- [6]. Ren-Chung Soong, Kuei-Shu Hsu and Feng-Tsai Weng, “A Programmable Geared Seven-bar Mechanism for Mechanical Forming Presses”, *Journal of the Chinese Society of Mechanical Engineers*, Vol.29, No.1, pp.61-67, 2008.
- [7]. Umesh M. Daivagna and Shrinivas S. Balli, “Synthesis of a Seven-Bar Slider Mechanism with Variable Topology for Motion between Two Dead-Center Positions”, *World*

- Congress on Engineering, Vol. II, pp. 1454-1459, 2010.
- [8]. Volken Parlaktas, Eres Soylemez and Engin Tanik, “On the synthesis of a geared four-bar mechanism”, *Mechanism and Machine Theory*, Vol.45, Issue 8, August 2010.
- [9]. Umesh M. Daivagna and Shrinivas S. Balli, “Synthesis of Five-Bar Slider Mechanism with Variable Topology for Finitely Separated Positions”, *Advances in Mechanical Engineering*, vol.2011, 2011.
- [10]. Prashant B. Tadalagi and Shrinivas S. Balli, “A Review on Mechanisms with Variable Topology (Revisiting the Variable Topology Mechanism)”, *IOP Conf. Series: Materials Science and Engineering*, Vol. 691, pp. 012047(1-9), 2019.
- [11]. H. M. Naveen, Shrinivas S. Balli and Umesh M. Daivagna, “Two FSP Synthesis of Eight Link Gear Mechanism for Motion Generation with 9R-1G Joints”, *International Journal of Engineering Applied Science and Technology*, Vol. 5, No. 3, pp. 288-294, 2020.
- [12]. H. M. Naveen, Shrinivas S. Balli and Umesh M. Daivagna, “Kinematic Synthesis of In-Line Ten Link Gear Slider Mechanism of Variable Topology with 12R-1G-1P Joints”, *International Research Journal of Engineering and Technology*, Vol. 7, No. 8, pp. 605-610, 2020.
- [13]. Prashant B. Tadalagi and Shrinivas S. Balli, “Limiting Positions Synthesis of Seven Bar Slider Automated Fiber Placement Mechanism for Motion Generation using Variable Topology”, *International Journal of Mechanical and Production Engineering Research and Development (IJMPERD)*, Vol. 10, Issue 3, pp. 13297–13308, 2020.
- [14]. Prashant B. Tadalagi and Shrinivas S. Balli, “Dead Centre Positions Synthesis off offset Seven Bar Slider Mechanism for Motion Generation using Variable Topology” , *GIS Science Journal*, Vol. 8, No.5, pp. 1613-1620, 2021.
- [15]. George N. Sandoor and Arthur G. Erdman, *Advanced Mechanism Design: Analysis and Synthesis*, Vol. II, Prentice-Hall, Englewood Cliffs, New Jersey, 1984.
- [16]. Shivamanappa G. Desai, Anandkumar R. Annigeri and A. TimmanaGouda, “Analysis of a new single degree-of-freedom eight link leg mechanism for walking machine”, *Mechanism and Machine Theory*, Vol. 140, pp. 747-764, 2019.
- [17]. Link for Linkage Software: <https://blog.rectorsquid.com/>



Journal Article Titled “Three-Dimensional Printing of Synthesized Eight Link Gear Variable Topology Mechanism with Fused Deposition Modeling Technique” © 2021 by Mr. H. M. Naveen, Dr. Shrinivas S. Balli and Dr. Umesh M. Daivagna is licensed under CC BY-NC-ND

4.0 

