



**HAL**  
open science

# **Tetramerization of Phosphoprotein Is Essential for Respiratory Syncytial Virus Budding while Its N-Terminal Region Mediates Direct Interactions with the Matrix Protein**

Monika Bajorek, Marie Galloux, Charles-Adrien Richard, Or Szekely, Rina Rosenzweig, Christina Sizun, Jean-Francois Eleouet

► **To cite this version:**

Monika Bajorek, Marie Galloux, Charles-Adrien Richard, Or Szekely, Rina Rosenzweig, et al.. Tetramerization of Phosphoprotein Is Essential for Respiratory Syncytial Virus Budding while Its N-Terminal Region Mediates Direct Interactions with the Matrix Protein. *Journal of Virology*, 2021, 95 (7), pp.02217-20. 10.1128/jvi.02217-20 . hal-03319085

**HAL Id: hal-03319085**

**<https://hal.science/hal-03319085>**

Submitted on 11 Aug 2021

**HAL** is a multi-disciplinary open access archive for the deposit and dissemination of scientific research documents, whether they are published or not. The documents may come from teaching and research institutions in France or abroad, or from public or private research centers.

L'archive ouverte pluridisciplinaire **HAL**, est destinée au dépôt et à la diffusion de documents scientifiques de niveau recherche, publiés ou non, émanant des établissements d'enseignement et de recherche français ou étrangers, des laboratoires publics ou privés.

1 **Tetramerization of Phosphoprotein is essential for Respiratory Syncytial virus**  
2 **budding while its N terminal region mediates direct interactions with the Matrix**  
3 **protein.**

4  
5 **Running title: Identification of P protein regions interacting with M protein**

6  
7 Monika Bajorek<sup>a\*</sup>, Marie Galloux<sup>a</sup>, Charles-Adrien Richard<sup>a</sup>, Or Szekely<sup>b</sup>, Rina  
8 Rosenzweig<sup>b</sup>, Christina Sizun<sup>c\*</sup>, Jean-Francois Eleouet<sup>a</sup>

9  
10 <sup>a</sup>Université Paris-Saclay, INRAE, UVSQ, VIM, Jouy-en-Josas, France.

11 <sup>b</sup>Department of Structural Biology, Weizmann Institute of Science, Rehovot, Israel.

12 <sup>c</sup>Institut de Chimie des Substances Naturelles, CNRS, Université Paris-Saclay, Gif-  
13 sur-Yvette, France.

14  
15 \*Corresponding authors: email: [monika.bajorek@inrae.fr](mailto:monika.bajorek@inrae.fr); [christina.sizun@cnrs.fr](mailto:christina.sizun@cnrs.fr)

16  
17 Word count; Abstract: 170, Text: 7,938

18  
19 **Abstract**

20 It was shown previously that the Matrix (M), Phosphoprotein (P), and the Fusion (F)  
21 proteins of Respiratory syncytial virus (RSV) are sufficient to produce virus-like  
22 particles (VLPs) that resemble the RSV infection-induced virions. However, the exact  
23 mechanism and interactions among the three proteins are not known. This work  
24 examines the interaction between P and M during RSV assembly and budding. We  
25 show that M interacts with P in the absence of other viral proteins in cells using a

26 Split Nano Luciferase assay. By using recombinant proteins, we demonstrate a  
27 direct interaction between M and P. By using Nuclear Magnetic Resonance (NMR)  
28 we identify three novel M interaction sites on P, namely site I in the  $\alpha_{N2}$  region, site II  
29 in the 115-125 region, and the oligomerization domain (OD). We show that the OD,  
30 and likely the tetrameric structural organization of P, is required for virus-like filament  
31 formation and VLP release. Although sites I and II are not required for VLP  
32 formation, they appear to modulate P levels in RSV VLPs.

33

### 34 **Importance**

35 Human RSV is the commonest cause of infantile bronchiolitis in the developed world  
36 and of childhood deaths in resource-poor settings. It is a major unmet target for  
37 vaccines and anti-viral drugs. The lack of knowledge of RSV budding mechanism  
38 presents a continuing challenge for VLP production for vaccine purpose. We show  
39 that direct interaction between P and M modulates RSV VLP budding. This further  
40 emphasizes P as a central regulator of RSV life cycle, as an essential actor for  
41 transcription and replication early during infection and as a mediator for assembly  
42 and budding in the later stages for virus production.

43

### 44 **Introduction**

45 Human RSV is the most frequent cause of infantile bronchiolitis and pneumonia  
46 worldwide (1). In France 460,000 infants are infected each year, of which ~30%  
47 develop lower respiratory infections and 4.8% to 6.7% are hospitalized, representing  
48 45% of the young children admissions at the hospital (2). The enormous burden of  
49 RSV makes it a major unmet target for a vaccine and anti-viral drug therapy.  
50 However, despite over 60 years of research since its discovery, there is still no

51 vaccine available, and RSV therapy remains mainly supportive. The current standard  
52 of care consists of prophylactic treatment of at-risk infants with Palivizumab  
53 (Synagis), a monoclonal antibody. However, its limited efficacy (approximately 50%),  
54 and high cost (€5.000 per treatment) limits its use to pre-term infants. As a result,  
55 60% of at risk children remain untreated, and no efficient therapy is available to treat  
56 the adult population (3). There are currently 39 vaccines under development (4). One  
57 of the strategies for RSV vaccine development is based on virus like particles  
58 (VLPs). However, all anti-RSV VLP vaccines currently in preclinical development are  
59 using foreign viral systems incorporating the RSV glycoproteins (5, 6). This is mostly  
60 due to the inefficiency of RSV VLP production (most of the virus is cell-associated in  
61 cell culture (7)), and to insufficient understanding of RSV particle assembly and  
62 budding. RSV VLPs, if they can be produced at sufficient levels, will accurately  
63 mimic the viral morphology and structure. Identification of the minimal players  
64 involved in particle assembly and budding is an important step in understanding the  
65 mechanism behind RSV particle formation. The knowledge can be then used for  
66 large scale VLPs and attenuated virus production for vaccination purpose.

67

68 RSV belongs to the *Pneumoviridae* family in the order *Mononegavirales* (8). It  
69 primarily infects epithelial cells of the respiratory tract and replicates in the  
70 cytoplasm. It is an enveloped, non-segmented, negative-strand RNA virus. The viral  
71 genome is encapsidated by the nucleoprotein (N), forming a ribonucleoprotein (RNP)  
72 complex, which constitutes the template for the viral polymerase. It was recently  
73 shown that the replication and transcription steps of RSV take place in virus-induced  
74 cytoplasmic inclusions called inclusion bodies (IBs), where all the proteins of the  
75 polymerase complex, i.e. the viral polymerase (L), its main co-factor the P protein,

76 the RNPs and the transcription factor M2-1 concentrate (9). It is noteworthy that  
77 pseudo-IBs, similar to those observed in RSV-infected cells, can be observed upon  
78 co-expression of only N and P (10, 11). We recently showed that the formation of  
79 these pseudo-IBs depends on a liquid-liquid phase separation induced by the N-P  
80 interaction (11). Once neo-synthesized, RNPs have to be exported from IBs to the  
81 plasma membrane, where RSV virions assemble and bud, forming elongated  
82 membrane filaments (12). According to the common paradigm, RSV assembles on  
83 the plasma membrane, and infectious viral particles are mainly filamentous (13, 14).  
84 However, recent data suggests that viral filaments are produced and loaded with  
85 genomic RNA prior to insertion into the plasma membrane. According to this model,  
86 vesicles with RSV glycoproteins recycle from the plasma membrane and merge with  
87 intracellular vesicles, called assembly granules, containing the RNPs (15, 16).

88

89 Regardless of the cellular location, the minimal RSV viral proteins required for  
90 efficient filament formation and budding of VLPs are P, M, and the F protein, more  
91 specifically its cytoplasmic tail (FCT) (17, 18). The atomic structure of the external  
92 part of F glycoprotein (excluding the transmembrane and cytoplasmic parts) has  
93 been resolved (19-21), but little is known about the FCT structure and its function in  
94 RSV assembly. M, a key structural protein, directs assembly and budding probably  
95 by interacting with FCT on the one hand, and with P associated to RNP on the other  
96 hand (22-24). M is required for filament elongation and maturation and, possibly, for  
97 transport of the RNP from IBs to the sites of budding (25). M was shown to localize  
98 to IBs where, presumably, the first interaction between M and the RNPs occurs.  
99 Some early reports have shown that M localization to IBs is mediated by interaction  
100 with M2-1 (26, 27). However, more recent work has demonstrated that M is found in

101 IBs when expressed with the N and P proteins alone (17). As N is not required for  
102 RSV virus-like filament formation, M was suggested to interact with P. However, the  
103 exact mechanism of interactions between these proteins remains largely unknown.  
104 Structural data published previously by our group showed that M forms dimers and  
105 that the switch from M dimers to higher order oligomers triggers assembly of viral  
106 filaments and virus production (28). Based on M structure, a long patch of positively  
107 charged surface spanning the entire monomeric protein was suggested to drive the  
108 interaction with a negatively-charged membrane (29).

109

110 Functional and structural data are available for the P protein, which is a  
111 multifunctional protein capable of interacting with multiple partners. Recent studies  
112 allowed better characterization of its interactions and functions within the viral  
113 polymerase complex. P forms tetramers of elongated shape composed of a central  
114 oligomerization domain (OD), mapped to residues N131-T151 (30-34), and of N- and  
115 C-terminal intrinsically disordered regions (IDRs). Structural study of P in solution by  
116 NMR gave insight into the secondary structure propensity of these IDRs, forming  
117 almost stable helices in the C-terminal region and extremely transient helices in the  
118 N-terminal region (35). Residues 1-29 in the N-terminal region confer a chaperone  
119 function to P, by binding monomeric and RNA-free N ( $N^0$ ) and by maintaining  $N^0$   
120 unassembled (36). P C-terminal residues 232-241 were shown to bind RNA-bound N  
121 assembled as rings mimicking the RNP (37). Very recently, the structure of the L  
122 protein bound to tetrameric P solved by cryo-electron microscopy revealed that each  
123 of the four P monomers adopts a distinct conformation upon binding to L, the entire  
124 L-binding region on P spanning residues 130-228. This includes the OD and the  
125 major part of the C-terminal domain (32, 38, 39). As part of viral transcription

126 regulation, P region spanning residues 98-109 was shown to be the binding site for  
127 the RSV transcription anti-termination factor M2-1 (40). This interaction is involved in  
128 the recruitment of M2-1 to IBs (41). P also plays a pivotal role in M2-1 de-  
129 phosphorylation mediated by the host protein PP1, which binds to P through an  
130 RVxF-like motif located at P residues 82-87 (41). Dephosphorylated M2-1 is  
131 recruited to specific regions in IBs, called IB associated granules (IBAGs), where  
132 viral mRNAs are concentrated, before trafficking back to the cytoplasm. This cycle is  
133 essential for RSV transcription and translation (41).

134

135 Recently, a P region encompassing residues 39–57 was found to be critical for VLP  
136 formation (42). In this study it was also observed that the OD of P had no significant  
137 contribution for VLP assembly and budding. Additionally, phosphomimetic  
138 substitutions in P region 39-57 inhibited VLP formation, suggesting that this region  
139 needs to be un-phosphorylated for VLP production (42). P region 110-120 was also  
140 shown to be required for efficient virus budding, affecting the final step of filament  
141 scission and virus release (42, 43). However, until now, no direct interaction between  
142 P and M has been shown. The lack of structural information on the putative M-P  
143 complex makes it difficult to speculate about the mechanism of budding. Thus,  
144 identifying specific RSV M-P protein-protein interactions has the potential to break  
145 new ground in our understanding of the mechanism behind RSV particle formation.  
146 This can further benefit RSV VLP-based vaccine research.

147

## 148 **Results**

149 **Specific localization of M depends on expression of F, P, and N proteins.**

150 As shown previously, RSV VLPs can be generated independently of viral infection by  
151 transfecting cells with plasmids encoding the RSV M, P, N, and F proteins (18, 28).  
152 Although N is not required for RSV filament formation (17), it localizes with M in  
153 filaments when present, and is required, together with P, for the formation of pseudo-  
154 IBs (18, 28). In a first attempt to study the co-localization of M with N and P proteins  
155 in pseudo-IBs and in virus-like filaments at the plasma membrane, and to confirm the  
156 minimal requirement for filament formation in our system, we used a transfection-  
157 based assay.

158 BEAS-2B cells were transfected to express M, N, P, and F, or various combinations  
159 of these four proteins. The intracellular localization of RSV proteins and the  
160 formation of pseudo-IBs and virus-like filaments were determined by confocal  
161 imaging after staining in parallel with either anti-M and anti-N antibodies (Fig. 1A), or  
162 anti-P and anti-N (Fig. 1B). In the presence of M, N, P, and F, the formation of  
163 pseudo-IBs and of virus-like filaments was detected by immunostaining of M, N and  
164 P. Co-localization of M, N, and P was detected on filaments at the plasma  
165 membrane as well as in pseudo-IBs, as shown in zoomed merged images (Fig. 1A  
166 and 1B, row 1, positive control). When F was absent, M, P, and N localized in  
167 pseudo-IBs (Fig. 1A and 1B, row 2). M, but not P or N, was also found in small  
168 spikes, most probably at the plasma membrane. In the absence of P or N, no  
169 pseudo-IBs formed, as expected (Fig. 1A and 1B, rows 3 and 4). In the absence of  
170 P, M was found only as small spikes, whereas N spread all throughout the cytoplasm  
171 (Fig. 1A and 1B, row 3). Finally, as previously reported, large filaments containing M  
172 and P formed in the absence of N (Fig. 1A and 1B, row 4). Altogether, our results  
173 confirm previous observations showing that only M, P, and F are required for virus-



174 like filaments formation, and that M co-localizes with N and P within pseudo-IBs and  
175 in virus-like filaments (17, 18, 26, 28).

176

### 177 **M interacts with P in cells**

178 As M localization in virus-like filaments seems to depend on P, we then studied  
179 whether M can interact with P in cells in the absence of other viral proteins. For that  
180 purpose, we used the NanoLUC interaction assay based on the split Nano  
181 Luciferase reporter (44). In this system, the 114 or the 11S Nano Luciferase  
182 fragments were fused to the C-terminus of viral proteins (Fig. 2A). Analysis of the  
183 lysates of transfected 293T cells by Western blotting using anti-P, anti-M, anti-N or  
184 anti-M2-1 antibody, confirmed protein expression with the fused NanoLUC fragments  
185 (Fig. 2B). In addition to the expected bands, a weak higher migrating band, probably  
186 unspecific, was detected in P114 and P-11S samples, whereas a double band was  
187 detected in M2-1-11S sample, corresponding most probably to the phosphorylated  
188 and unphosphorylated forms of M2-1 (41). To investigate the P-M interaction,  
189 combinations of two constructs were transfected into 293T cells. 24 h post  
190 transfection cells were lysed, luciferase substrate was added, and the luminescence,  
191 proportional to the strength of the interaction, was measured (Fig. 2C). As P is  
192 known to form tetramers (30-35), P/P interaction was used as positive control. As  
193 shown in Fig. 2C, transfection of P-114/P-11S resulted in a high luminescence  
194 signal, indicating a strong interaction. We also used the P-N interaction as a control:  
195 when co-expressing P-114 and N-11S, positive but relatively low luminescence was  
196 observed. Here, as the NanoLUC 114 subunit was cloned at the C-terminus of P  
197 protein, thus blocking the interaction between the C-terminus of P and RNA-bound  
198 N, the luminescence signal corresponds to the P-N<sup>0</sup> interaction, which was

199 previously shown to be rather weak, in the micromolar range (36). When M-114 was  
200 co-expressed with P-11S, the luminescence signal was similar to the P-N<sup>0</sup> signal,  
201 suggesting that M interacts with P with similar affinity compared to P-N<sup>0</sup> interaction.  
202 In contrast, expression of M-114 with M2-1-11S did not produce luminescence,  
203 suggesting that M and M2-1 did not interact when co-expressed in cells in our  
204 system. However, for this negative result, we cannot exclude that the C-terminal tag  
205 blocks protein-protein interactions that occur via the C-terminus of one or both  
206 proteins.

207

### 208 **M directly interacts with P via its N-terminal region and OD**

209 Next, we investigated whether M directly interacts with P *in vitro* using recombinant  
210 proteins, and determined the P region involved in the interaction. Based on structural  
211 data available for isolated P (30, 35), we generated rational deletions of each  
212 subdomain of P (Fig. 3A). While P fragments lacking the OD (P<sub>ΔOD</sub>, P<sub>1-126</sub> and P<sub>161-</sub>  
213 <sub>241</sub>) were shown to be monomeric by NMR, P fragments containing the OD (full-  
214 length P, P<sub>OD</sub>, P<sub>1-163</sub> and P<sub>127-241</sub>) appeared to be associated via the OD (35). The  
215 purity and the size of all the P fragments were controlled by SDS-PAGE (Fig. 3B). M  
216 and full-length P or P fragments were co-incubated and the formation of complexes  
217 was analysed by native agarose gel electrophoresis. Of note, in native gels proteins  
218 migrate according to the combination of their size, shape and charges. This explain  
219 why P<sub>ΔOD</sub> migrates at higher apparent molecular weight than full-length P, as the  
220 global charges are -20.7 for monomeric P<sub>ΔOD</sub> and -86.8 for tetrameric P at pH 7.4.  
221 When M was incubated with P fragments, shifts were observed only with full-length P  
222 and P<sub>1-163</sub> (Fig. 3C), indicating that the N-terminal domain of P (residues 1-131) and  
223 the OD (residues 131-151) are together required for a stable P-M interaction in this

224 system. Additionally, no shift was observed neither for  $P_{\Delta OD}$  nor for  $P_{1-126}$  when  
225 incubated in the presence of M. This suggests that either the M-binding site is at  
226 least partly on the OD of P, or that M interaction requires tetrameric P. Since no shift  
227 was observed for  $P_{OD}$ ,  $P_{127-241}$  and  $P_{161-241}$  when incubated with M, these results  
228 showed that neither the OD nor the C-terminal region of P on their own or together  
229 were sufficient for a detectable P-M interaction *in vitro*.

230 Based on these results, we next wanted to assess if a P fragment containing the N-  
231 terminal region and the OD was sufficient to interact with M and to induce membrane  
232 filaments in cells. We used the  $P_{1-161}$  fragment, shorter than  $P_{1-163}$  by two residues,  
233 which are outside of the OD on the C-terminal side. Again, we used the filament  
234 formation assay. BEAS-2B cells were transfected to express M, N, F and P,  $P_{1-161}$  or  
235  $P_{1-126}$  constructs, and the formation of RSV virus-like filaments was determined by  
236 confocal imaging after staining with anti-M and anti-P primary antibodies (Fig. 3D).  
237 As previously shown (Fig. 1), in the presence of M, N, F, and P, the formation of  
238 pseudo-IBs and virus-like filaments was observed, and M co-localized with P in both  
239 structures (Fig. 3D, row 1, positive control). Co-localization was not seen in all  
240 pseudo-IBs, but this could reflect different maturation states of pseudo-IBs. In the  
241 absence of P or when  $P_{1-126}$  was expressed, neither IBs nor virus-like filaments were  
242 detected, and M was found in small spikes (Fig 3D, row 2 and 4). Virus-like filaments  
243 were detected when the  $P_{1-161}$  construct was expressed, and M- $P_{1-161}$  co-localization  
244 occurred in virus-like filaments (Fig 3D, row 3). These results are in agreement with  
245 those obtained with the gel shift assay using recombinant proteins (Fig. 3C), and  
246 confirmed that the  $P_{1-161}$  fragment is competent for M binding and for filament  
247 formation. It is noteworthy that under these conditions no pseudo-IBs were detected,  
248 because the interaction between the C-terminus of P (missing in the  $P_{1-161}$  construct)

249 and N is critical for their formation (45). Altogether, our results show that the P<sub>1-161</sub>  
250 fragment is sufficient to interact with M and to induce the formation of virus-like  
251 filaments in cells in presence of M, N, and F.

252

### 253 **Identification of M interaction sites on P by NMR**

254 Next, we sought for a method to identify the M interaction site on P, in a residue–  
255 specific manner, without resorting to mutations or internal deletions in potential  
256 regions of interest. We have previously used NMR to localize molecular recognition  
257 features (MoRFs) on P, taking advantage of the intrinsically disordered nature of this  
258 protein (46). Perturbations in amide <sup>1</sup>H-<sup>15</sup>N correlation spectra, either of intensities  
259 (Fig. 4A and 5) or chemical shifts, were used to map regions that sense direct  
260 interaction and/or conformational changes due to binding of a partner.

261 To control the oligomerization state of M, we used the M-Y229A mutant, which was  
262 shown to form dimers, but is less prone to form higher order oligomers as compared  
263 to WT M (28). No aggregation or self-assembly of M-Y229A was observed, as the  
264 samples stayed clear and M-specific signal was detected in <sup>1</sup>H NMR spectra, also in  
265 the presence of P (Fig. 4B). Of note, since M-Y229A is a dimeric 2x29 kDa folded  
266 protein, M signals are much broader than P signals that stem from the intrinsically  
267 disordered N-terminal region of P. This was also verified by SEC analysis made after  
268 NMR measurements (data not shown). A buffer with reduced ionic strength (150 mM  
269 NaCl as compared to 300 mM, the usual M storage buffer (13)) was used to enhance  
270 potential electrostatic interactions between M and P. The temperature was set to 288  
271 K to increase the stability of M in this buffer, and also to reduce NMR signal  
272 broadening of solvent-exposed amide protons due to exchange with water. The final  
273 concentration of M was set to 100 μM. Concentrations and molar ratios are given for

274 protomers, independently of the oligomerization state of the proteins. Since the C-  
275 terminal part of P seemed to be dispensable for interaction with M and for virus-like  
276 filament formation (Fig. 3), we performed experiments with  $^{15}\text{N}$ -labeled P fragments  
277 devoid of this part rather than with full-length P: this reduces signal overlap in  $^1\text{H}$ - $^{15}\text{N}$   
278 correlation spectra.

279 Incubation of  $^{15}\text{N}$ -labeled  $\text{P}_{1-163}$  with M-Y229A at a P:M molar ratio of 1:4 (25  $\mu\text{M}$  P  
280 and 100  $\mu\text{M}$  M) resulted in significant intensity decrease of several  $\text{P}_{1-163}$  amide  
281 signals in 2D  $^1\text{H}$ - $^{15}\text{N}$  correlation NMR spectra (Fig. 4A). These perturbations took  
282 place in two proximal regions located immediately upstream of the OD: in the  $\alpha_{\text{N}2}$   
283 region (residues 98-111) and in a stretch spanning residues 115-125 (Fig. 4C). The  
284 first corresponds to the extremely transient helix  $\alpha_{\text{N}2}$ , previously identified as the  
285 binding site of RSV M2-1 protein (46, 47). Due to specific dynamics in the  $\alpha$ -helical  
286 coiled-coil OD, amide  $^1\text{H}$ - $^{15}\text{N}$  signals are broadened out beyond detection at 288 K  
287 for P fragments that contain the OD flanked by N- and/or C-terminal extensions (46).  
288 Hence, M-binding to the OD could not be assessed using  $\text{P}_{1-163}$ .

289 A concentration effect for  $\text{P}_{1-163}$  was evidenced by comparing the intensity ration  $I/I_0$   
290 measured with two different P:M molar ratios (Fig. 4C). A maximal effect, where  
291 signals disappear completely, could not be reached, because M could not be  
292 concentrated above 100  $\mu\text{M}$  without starting to aggregate and because the  
293 concentration of  $^{15}\text{N}$ -labeled P had to be kept  $>10$   $\mu\text{M}$  due to the sensitivity limitation  
294 of NMR. Altogether, the NMR experiments with  $\text{P}_{1-163}$  show that an interaction takes  
295 place between  $\text{P}_{1-163}$  and M-Y229A, which involves a region immediately upstream of  
296 the OD. This interaction is rather weak. A set of NMR data with  $\text{P}_{1-163}$  and M-Y229A  
297 was also acquired in a buffer with 300 mM NaCl and compared to 150 mM NaCl  
298 (Fig. 4D). Overall intensity perturbation is larger with lower salt concentration,

299 indicating that M-Y229A binding is stronger under these conditions and suggesting  
300 that there may be an electrostatic contribution to the P-M interaction.

301 To assess the role of the OD, we used the P<sub>1-126</sub> fragment, which is devoid of it.  
302 When incubated with 4 molar equivalents of M-Y229A, no significant effect was  
303 observed in the intensities of the <sup>1</sup>H-<sup>15</sup>N correlation spectrum (Fig. 5A and 5D, upper  
304 panel), indicating that the OD is required for M binding. These results correlate well  
305 with the band shift experiments for the M/P complex using native gel analysis (Fig.  
306 3C). To further characterize the binding site on P<sub>1-163</sub>, we performed NMR  
307 interactions experiments using the shorter P<sub>113-163</sub> fragment, which contains only the  
308 OD flanked by residues 115-130 and 152-163 (Fig. 5B and 5D, lower panel). In the  
309 presence of M-Y229A, NMR signal intensities decreased by 30 % upstream and  
310 downstream of the OD. A stronger effect was again observed for residues 115-125  
311 (Fig. 5B and 5D, lower panel), suggesting that they play a particular role in M  
312 binding. Like for P<sub>1-163</sub>, the OD could not be observed for P<sub>113-163</sub> fragment at 288 K.  
313 However, these signals become visible at higher temperature for P<sub>113-163</sub> (Fig. 5B  
314 and 5D, lower panel). The intensity perturbation pattern of P<sub>113-163</sub> at 298 K suggests  
315 that the OD region is affected by the presence of M-Y229A. For P<sub>120-160</sub>, the smallest  
316 fragment used in this study, all amide signals can be observed, even at 288 K (Fig.  
317 5C). M-Y229A induces a weak global reduction in intensity that may point to weak  
318 binding to P<sub>120-160</sub>. Taken together, these results suggest that M binding to P is  
319 achieved through multiple contact sites that are located in α<sub>N2</sub> (site I), in the 115-125  
320 region (site II) and potentially in the OD. Binding to any of these sites appears be  
321 rather weak, and M binding to the two N-terminal P regions requires tetrameric P.

322

323 **Validation of M-binding sites on P using P deletion mutants**

324 In order to validate the NMR data showing multiple M binding sites, we then  
325 performed band shift assays with different fragments of P. We generated P deletions  
326 using P<sub>1-163</sub> as a template and deleted a different part of the N-terminal domain for  
327 each construct. The OD was present in all constructs to keep the P protein as a  
328 tetramer (Fig. 6A). Each construct contained different M-binding domains. P<sub>40-163</sub>  
329 contained the region spanning residues 39-57, previously reported to affect RSV  
330 assembly and potentially being involved in M interaction (42), as well as all binding  
331 sites identified by NMR (Fig. 4 and 5). P<sub>80-163</sub> contained the two potential binding  
332 sites I and II identified by NMR. P<sub>113-163</sub> contained only site II, and P<sub>120-160</sub> lacked both  
333 sites, containing only the OD. We used both WT M and M-Y229A in order to  
334 ascertain that the NMR results were not biased by the Y229A M mutation. M  
335 proteins, full-length P and P fragments were purified as previously and analysed by  
336 SDS-PAGE (Fig. 6B). M and P constructs were co-incubated before analysis of  
337 complexes by native agarose gel electrophoresis (Fig. 6C). Shifts were observed  
338 with full-length P and P<sub>1-163</sub>, as shown above in Fig. 3C. P<sub>40-163</sub> and P<sub>80-163</sub> fragments  
339 (containing both sites I and II and OD) also induced a shift. No band shift was  
340 detected when M was incubated with P<sub>113-163</sub> (containing only site II and OD) or with  
341 P<sub>120-160</sub>. Similar shifts were observed for M WT and M Y229A. This is in line with our  
342 NMR results (Fig. 4 and 5), indicating that M binding by P is achieved through  
343 multiple sites. Interactions seen by NMR with P<sub>113-126</sub> or P<sub>120-160</sub> were not strong  
344 enough to induce a band shift when analyzed by native gel electrophoresis.

345 In order to verify which of the identified specific M/P binding regions is relevant for  
346 interaction between M and P in cells, we used again the NanoLUC interaction assay  
347 based on the split Nano Luciferase reporter. The 114 or the 11S Nano Luciferase  
348 fragments were fused to the C-terminus of M and P proteins (Fig. 2A). P<sub>WT</sub> and four



349 P deletion mutants were analysed: P<sub>Δ39-57</sub> (deleted of the region previously reported  
350 to be involved in M/P interaction (42)), P<sub>Δ93-126</sub> (lacking sites I and II as identified by  
351 NMR), P<sub>Δ39-57,Δ93-126</sub> (lacking the three regions), and P<sub>ΔOD</sub>. Combinations of two  
352 proteins were transfected into 293T cells. 24 h post transfection cells were lysed,  
353 luciferase substrate was added, and the luminescence, proportional to the strength  
354 of the interaction, was measured (Fig. 6D). P/P interaction was again used as  
355 positive control. As shown in Fig. 6D, transfection of P-114/P-11S resulted in high  
356 luminescence signal, indicating a strong interaction. Transfection of M-114 and P-  
357 11S resulted in positive signal (comparable to Fig. 2C). Transfection of P<sub>Δ39-57</sub>-11S,  
358 P<sub>Δ93-126</sub>-11S, or P<sub>Δ39-57, Δ93-126</sub>-11S and M-114, all resulted in luminescence  
359 comparable to transfection when P-11S was used. In contrast, when M-114 was  
360 transfected with P<sub>ΔOD</sub>-11S, luminescence signal was almost completely lost. These  
361 results indicate that, in transfected cells, P OD deletion, and as a consequence  
362 abrogated tetramerization, resulted in loss of interaction with M, whereas deletion of  
363 amino acids 39-57, 93-126 or both regions did not. Of note, analysis of the lysates of  
364 transfected 293T cells by Western blotting using anti-P or anti-M antibody confirmed  
365 correct protein expression with the fused NanoLUC fragments (Fig. 6E).

366

### 367 **Functional implications of P regions displaying direct M-binding**

368 Next, we asked whether the identified M-binding domains on P were of functional  
369 significance. We analysed virus-like filament formation using full-length P or deletion  
370 constructs based on NMR results and on previous publications. Specifically, we  
371 checked full-length P, P<sub>1-161</sub>, P<sub>ΔOD</sub>, P<sub>Δ39-57</sub>, P<sub>Δ93-110</sub> (deleted of M-binding site I), P<sub>Δ113-  
372 126</sub> (deleted of M-binding site II), and P<sub>Δ93-126</sub> (deleted of both sites I and II as  
373 identified by NMR) (Fig. 7A). BEAS-2B cells were transfected to express M, N, F and



374  $P_{WT}$  or various P deletion constructs, and the formation of RSV virus-like filaments  
375 was determined by confocal imaging and immuno-fluorescence after staining with  
376 anti-M and anti-P primary antibodies (Fig. 7B). Transfecting M, N, F and P resulted in  
377 pseudo-IBs and filament formation, and co-localization of M and P proteins in both  
378 (positive control, Fig. 7B, upper left). Transfecting M, N, F and  $P_{\Delta OD}$  did not produce  
379 any virus-like filaments or pseudo-IBs, and M and P did not co-localize (Fig. 7B,  
380 lower left). Cells expressing  $P_{\Delta 39-57}$  failed to produce virus-like filaments, and  
381 although P was found in pseudo-IBs, M was not recruited to IBs (Fig. 7B, upper  
382 right). Transfection of  $P_{\Delta 93-126}$  resulted in virus-like filament formation (Fig. 7B, lower  
383 right), and both M and P proteins were found in virus-like filaments, similar to  $P_{WT}$ ,  
384 showing that sites I and II are not critical for these processes.

385 Finally, we asked whether P deletion mutants could negatively affect VLP release.  
386 HEP-2 cells were transfected to express M, F, and various P constructs. The N  
387 protein was not included in the assay, since it is not required for VLP production (Fig.  
388 1 and (17)). Cell lysates (soluble fractions) and the VLPs released into the media  
389 were analysed by Western blotting using anti-P and anti-M antibodies (Fig. 7C,  
390 upper panel). All P mutants were correctly expressed and were well detected by the  
391 anti-P antibody, as shown by the bands in the cell lysates. Quantification of relative  
392 M and P levels in the VLPs, revealed by WB, is shown in Fig. 7C, lower panel. When  
393  $P_{WT}$  was expressed, VLP release was validated using anti-M antibodies, and P was  
394 detected in VLPs using anti-P antibodies (positive control). The absence of P  
395 prevented VLP release (negative control). The  $P_{1-161}$  construct resulted in VLP  
396 release comparable to  $P_{WT}$ . Expression of  $P_{\Delta OD}$  greatly reduced VLP release, as  
397 almost no M could be detected.  $P_{\Delta 39-57}$  abolished VLP release, as no M and P were  
398 detected. This is in agreement with our virus-like filament formation assay (Fig. 7B),

399 where neither  $P_{\Delta OD}$  nor  $P_{\Delta 39-57}$  induced filament formation. Transfection of  $P_{\Delta 93-110}$ ,  
400  $P_{\Delta 113-126}$  or  $P_{\Delta 93-126}$  mutants did not abolish VLP release, as M was detected in the  
401 VLP fraction at comparable levels to  $P_{WT}$  with  $P_{\Delta 93-126}$ , or slightly reduced with  $P_{\Delta 93-}$   
402  $110$  and  $P_{\Delta 113-126}$ .  $P_{\Delta 93-110}$  incorporation into released VLPs was comparable to that of  
403  $P_{1-161}$ , i.e. with a 25-30% reduction relative to  $P_{WT}$ . In contrast, transfection of  $P_{\Delta 113-}$   
404  $126$  and even more of  $P_{\Delta 93-126}$  greatly reduced detection of these mutants in released  
405 VLPs. This suggests that  $P_{\Delta 113-126}$  and  $P_{\Delta 93-126}$  mutants still supported VLP formation,  
406 in contrast to  $P_{\Delta OD}$  and  $P_{\Delta 39-57}$ , but could be more easily displaced from VLPs than  
407  $P_{\Delta 93-110}$ ,  $P_{1-161}$  or  $P_{WT}$ . This effect appears to be linked to the deletion of site II. It was  
408 not evidenced in the virus-like filament formation assay carried out with  $P_{\Delta 93-126}$  (Fig.  
409 7D), most likely because of milder conditions.

410

## 411 Discussion

### 412 RSV M makes a direct interaction with RSV P

413 It was reported earlier that the three proteins, RSV P, M and F were sufficient for  
414 virus-like filament formation and VLP release (17). Our results confirm this minimal  
415 requirement (Fig. 1). A question that remained open was which interactions M  
416 needed to be involved in to promote assembly and budding of viral particles. For  
417 *Paramyxoviridae* it was shown that M proteins organize viral assembly by bridging  
418 between the glycoproteins and the RNPs, and that specific M-N interactions were  
419 required for the RNP to be packed into viral pseudo-particles (48). The interaction  
420 between the RNP and M proteins occurs most probably first in IBs and/or assembly  
421 granules (16), where M recruits the RNP, before they are transported to viral  
422 filaments formed on the cellular membrane.

423 Here we showed that M co-localized with P in pseudo-IBs, which are formed when N  
424 and P are present, as well as in virus-like filaments, even in the absence of N (Fig.  
425 1). Our NanoLUC results showed that M could interact with P in the absence of other  
426 viral proteins in cells (Fig. 2). Gel shift assays performed with purified recombinant M  
427 and P fragments (Fig. 3C) confirmed M and P could directly interact. Moreover, our  
428 data indicated that the P domain responsible for this M interaction was located in  
429 fragment P<sub>1-163</sub>, comprising the N terminal domain and the OD of P (Fig. 3C and Fig.  
430 6C). When M was co-expressed with P<sub>1-161</sub>, no pseudo-IBs were formed, as  
431 expected, since P<sub>1-161</sub> lacks the C-terminus of P needed for interaction with RNA-N  
432 complexes and formation of IBs (11, 37, 45). However, virus-like filaments were  
433 formed, where M and P<sub>1-161</sub> co-localized. This argues against the requirement of  
434 preliminary IB formation before virus-like filament assembly, as these were observed  
435 in cells transfected with RSV M, P, and F only. Furthermore, an interaction between  
436 RSV M and P strongly suggests that for RSV assembly, bridging between M and the  
437 RNP might be mediated by P.

438

#### 439 **P displays multiple direct contact sites for M**

440 According to our NMR data (Fig. 4 and 5), M binding to P could be achieved through  
441 multiple contact sites that are located within three regions,  $\alpha_{N2}$  region (site I), the  
442 115-125 region (site II) and the OD (Fig. 5). It must be noted that NMR experiments  
443 were carried out with the M-Y229A mutant, which stays dimeric in solution. The  
444 interactions observed by NMR therefore represent a P-M complex formed with  
445 dimeric M. The NMR results were corroborated *in vitro* by native gel interaction  
446 assays using both M WT and M-Y229A and N-terminally truncated P fragments (Fig.  
447 3 and 6). Interestingly, neither sites I and II together but without the OD (P<sub>1-126</sub> as

448 compared to P<sub>80-163</sub> or P<sub>1-163</sub>) nor the OD without sites I and II (P<sub>120-160</sub> as compared  
449 to P<sub>80-163</sub>) seemed to be sufficient to bind M (Fig. 3C, 4, 5 and 6C). The split  
450 luciferase assay shed another light on the complexity of M-P interactions. The  
451 deletion of the internal N-terminal region spanning site I and II did not impair M  
452 binding *in cellula*, in contrast to the internal deletion of the OD, which completely  
453 impaired the M-P interaction under the same conditions (Fig. 6D). This could indicate  
454 that other short intrinsically disordered N-terminal motifs, similar in sequence to sites  
455 I or II, could complement the M-binding site, as they are closer to the OD than in P<sub>WT</sub>  
456 due the 30-residue long truncation, or that cellular proteins help stabilize the M-P  
457 complex. Interestingly, as illustrated by the P<sub>Δ39-57</sub> deletion mutant, highlighting the  
458 essential role of the 39-57 region (42), the ability to form an M-P complex *in cellula* is  
459 not correlated with virus-like filament formation or P-M co-localization on these virus-  
460 like filaments (Fig. 6D and 7B).

461 Although P OD is not sufficient to bind M, it seems to play a major role, possibly  
462 because of the higher level of structural organization provided by tetramerization. We  
463 previously showed that transient intra-protomer interactions take place in P (35), and  
464 the cryo-EM structures of *Pneumoviridae* L-P complexes show that the four  
465 protomers can engage each in different interaction in a single complex (32, 38, 39).  
466 This suggests that the P-M interactions are complex and probably cooperative, and  
467 that M could recognize one or several sites only formed when four P protomers are  
468 present.

469 As can be seen from *Pneumoviridae* P protein sequence alignment (Fig. 8), the N-  
470 terminal P region contains conserved motifs, in particular the N<sup>0</sup>-binding motif, the  
471 RVxF-like motif, which is the binding site for cellular PP1 phosphatase (41), and α<sub>N2</sub>,  
472 which is the binding site for M2-1 protein. This region also contains conserved

473 clusters of negatively charged residues, notably just upstream and inside binding site  
474 II. As indicated by reduced M-P binding in high salt buffer, these residues could be  
475 important for interaction with M, which displays a large positively charged surface  
476 patch (29). Finally, the differences observed between *in vitro* and *in cellula*  
477 experiments could also depend on post-translational modifications of the proteins.

478

#### 479 **Functional relevance of direct binding between M and P**

480 Our virus-like filament formation and VLP assays shed light on the functional  
481 implications of these interactions. Whereas the OD, and likely tetrameric  
482 organization provided by the OD, was clearly needed for VLP formation, deletion of  
483 sites I or II individually, or both at the same time, did not prevent virus-like filament  
484 production (Fig. 7B). However, reduced levels of P were detected in released VLPs,  
485 when both sites I and II were simultaneously deleted (Fig. 7C). This could be  
486 attributed to detachment of mutated P from released VLPs rather than defective  
487 recruitment to virus-like filaments, since co-localization was observed in these  
488 structures (Fig. 7B). This could also rise the question about the integrity of these  
489 VLPs.

490 M binding sites I and II thus rather appear to modulate P binding to M and to affect  
491 the final organization of the VLPs. The newly identified sites I and II also stand in  
492 contrast to the previously reported functional importance of the P region spanning  
493 residues 39-57 (42). In agreement with previously published data, we confirm that  
494 P<sub>Δ39-57</sub> completely prevented filament formation and VLP budding (Fig. 7B and 7C).  
495 However, no perturbations were detected in the NMR signals in the 39-57 region of  
496 P in presence of M-Y229A (Fig. 4). The P-M interaction was still detected when  
497 residues 39-57 were deleted in transfected cells (Fig. 6D), indicating that this is

498 probably not a direct binding region for M, at least not in its dimeric form.  
499 Dephosphorylation of the Ser/Thr-rich 39-57 region of P was reported to be required  
500 for VLP formation (42). This was the case for recombinant P protein produced in *E.*  
501 *coli*. As shown by our IF confocal microscopy experiments (Fig. 7B), M failed to co-  
502 localize to pseudo-IBs when P<sub>Δ39-57</sub> was expressed. This could indicate that a third,  
503 possibly cellular factor is required for M recruitment to IBs. Some early reports have  
504 shown that M localization to IBs was mediated by an interaction with M2-1 (26, 27),  
505 and M interaction with M2-1 in cells was shown by co-IP (49). Cryo-EM analysis of  
506 RSV filamentous particles showed that M2-1 is located between M layer and RNP  
507 (14, 50, 51). However, our work here shows that M2-1 is not required for M  
508 localization into pseudo-IBs (Fig. 1). Moreover M and M2-1 did not interact in our  
509 NanoLUC assay (Fig. 2).

510 In conclusion, our virus-like filament formation and VLP assays show a strong  
511 functional relevance of P region 39-57, which is essential for M localization to IBs  
512 and budding process, but most probably not due to a direct P-M binding. In addition,  
513 we show the functional importance of the tetramerisation of P, occurring via the short  
514 OD region. The OD is probably part of the M interaction site with P, but must be  
515 complemented by the N-terminal region of P to bind M (Fig. 7).

516

### 517 **Possible role for RSV P as a switch between transcription and budding**

518 Although the functional relevance of binding site I ( $\alpha_{N2}$  region) could not be fully  
519 assessed in the framework of this study, it is striking that it completely overlaps with  
520 the binding site of transcription anti-termination factor M2-1, which is an essential  
521 factor for efficient RSV transcription (52) (Fig. 8). It is likely that RNA synthesis  
522 processes are frozen just before viral budding. However, such mechanism has not

523 been clearly investigated to our knowledge. It is established that P plays a critical  
524 role in viral transcription, viral RNA synthesis and budding. In particular, interaction  
525 of P with M2-1 is critical for M2-1 recruitment to IBs (53). The overlap of binding sites  
526 for two essential proteins driving transcription (M2-1) on the one hand and virus  
527 assembly (M) on the other hand, could be part of a switch mechanism, where both  
528 proteins compete for this site. Interestingly, binding sites I and II contain four  
529 reported phosphorylation sites on T108 (54), S116, S117 and S119 (43), which are  
530 conserved among RSV P proteins (Fig. 8). Previously published data showed that P  
531 phosphorylation on residue T108 abolished P-M2-1 interaction (54). Phosphomimetic  
532 mutants of P serines 116, 117 and 119 (inside binding site II) were reported to  
533 significantly prevent virus budding (43). Moreover, P lacking residues 110-120  
534 reduced budding, which was completely restored when these residues were added  
535 to P (42). P is known to be highly phosphorylated in purified virions, and the timing of  
536 appearance of phosphorylated P was shown to correspond to the release of RSV  
537 virions (55). We therefore suggest that the phosphorylation state of P sites I and II  
538 could regulate the switch between RSV transcription/replication and assembly.

539 In summary, our work further confirms that RSV P protein is a multifunctional protein  
540 playing different roles depending on its interactions with other viral proteins. We  
541 confirm here that P plays a key role in RSV assembly. We also bring evidence for a  
542 direct interaction between M and P, P OD being required for M-P interaction and  
543 sites I and II modulating P binding to M in VLPs by mechanisms yet to uncover.

544

## 545 **MATERIALS AND METHODS**

### 546 **Plasmid constructs**

547 pcDNA3.1 codon-optimized plasmids for mammalian expression encoding the RSV  
548 A2 M, P, N, F, and M2-1 proteins were a gift from Marty Moore, Emory University  
549 (56). Commercially made pciNanoLUC 114 and 11S vectors (GeneCust) were used  
550 to clone the RSV A2 codon-optimized M, P, N, and M2-1 constructs using standard  
551 PCR, digestion and ligation techniques. pcDNA P<sub>1-126</sub> and P<sub>1-161</sub> deletion mutants of  
552 P were obtained by introducing stop codons at the appropriate site in the coding  
553 sequence. All pcDNA3.1 P deletion mutants in the full-length construct were  
554 generated by using the Q5 site-directed mutagenesis kit (New England BioLabs),  
555 following the manufacturer recommendations. pciNanoLUC 11S P<sub>Δ39-57</sub>, P<sub>Δ93-126</sub>, P<sub>Δ39-  
556 57, Δ93-126</sub>, and P<sub>ΔOD</sub> mutants were obtained by re-cloning the relevant constructs from  
557 pcDNA vector using standard PCR, digestion and ligation techniques. For  
558 expression and purification of recombinant P proteins, the previously described  
559 pGEX-P, and pGEX-P<sub>1-126</sub>, pGEX-P<sub>1-163</sub>, pGEX-P<sub>ΔOD</sub>, pGEX-P<sub>127-241</sub> and pGEX-P<sub>161-241</sub>  
560 plasmids were used (36). pGEX-P<sub>OD</sub>, pGEX-P<sub>40-163</sub>, pGEX-P<sub>80-163</sub>, pGEX-P<sub>113-163</sub>, and  
561 pGEX-P<sub>120-160</sub> were generated using standard PCR, digestion and ligation techniques  
562 and introducing codons at the appropriate site in the coding sequence. It is important  
563 to note that pcDNA P<sub>1-161</sub> and pGEX P<sub>1-163</sub> were used for cellular expression or for  
564 bacterial expression respectively. For expression and purification of recombinant M  
565 protein, the previously described pCDF-M and pCDF-M<sub>Y229A</sub> were used (28).

566

## 567 **Cell culture**

568 HEp-2 (ATCC CCL-23<sup>TM</sup>) and 293T cells were maintained in Dulbecco modified  
569 Eagle medium (eurobio) supplemented with 10% fetal calf serum (FCS; eurobio), 1%  
570 L-glutamine, and 1 % penicillin streptomycin. The transformed human bronchial  
571 epithelial cell line (BEAS-2B) (ATCC CRL-9609) was maintained in RPMI 1640



572 medium (eurobio) supplemented with 10% fetal calf serum (FCS; eurobio), 1% L-  
573 glutamine, and 1% penicillin-streptomycin. The cells were grown at 37°C in 5% CO<sub>2</sub>.

574

### 575 **Bacteria expression and purification of recombinant proteins**

576 For M expression (WT and Y229A mutant), *E. coli* Rosetta 2 bacteria transformed  
577 with the pCDF-M plasmid were grown from fresh starter cultures in Luria-Bertani (LB)  
578 broth for 5 h at 32°C, followed by induction with 0.4 mM isopropylthi-galactoside  
579 (IPTG) for 4 h at 25°C. Cells were lysed by sonication (4 times for 20 s each time)  
580 and lysozyme (1 mg/ml; Sigma) in 50 mM NaH<sub>2</sub>PO<sub>4</sub>-Na<sub>2</sub>HPO<sub>4</sub>, 300 mM NaCl, pH  
581 7.4, plus protease inhibitors (Roche), RNase (12 g/ml, Sigma), and 0.25% CHAPS  
582 {3-[(3-cholamidopropyl)-dimethylammonio]-1-propanesulfonate}, . Lysates were  
583 clarified by centrifugation (23,425 g, 30 min, 4°C), and the soluble His<sub>6</sub>-M protein  
584 was purified on an Nickel sepharose column (HiTrap™ 5 ml IMAC HP; GE  
585 Healthcare). The bound protein was washed extensively with loading buffer plus 25  
586 mM imidazole and eluted with a 25 to 250 mM imidazole gradient. M was  
587 concentrated to 2 ml using Vivaspin20 columns (SartoriusStedimBiotec) and  
588 purified on a HiLoad 10/600 Superdex S200 column (GE Healthcare) in 50 mM  
589 NaH<sub>2</sub>PO<sub>4</sub>-Na<sub>2</sub>HPO<sub>4</sub>, 300 mM NaCl, pH 7.4. The M peak was concentrated to 3  
590 mg/ml using Vivaspin4 columns. The quality of protein samples was assessed by  
591 SDS-PAGE. Protein concentration was determined by measuring absorbance at 280  
592 nm. For NMR interaction experiments a fresh preparation of M was dialyzed into  
593 NMR buffer.

594 For P expression, *E.coli* BL21 (DE3) bacteria transformed with pGEX-P derived  
595 plasmids were grown at 37°C for 8 h in LB. Protein expression was induced by  
596 adding one volume of fresh LB medium, 0.4 mM IPTG for 16 h at 28°C. Bacterial

597 pellets were resuspended in lysis buffer (20 mM Tris/HCl pH 7.4, 60 mM NaCl, 1 mM  
598 EDTA, 1 mg/mL lysozyme, 1 mM DTT, 0,1% Triton X-100) supplemented with  
599 complete protease inhibitor cocktail (Roche) for 1 h on ice. Benzonase (Millipore)  
600 was then added and the lysate was incubated for 1 h at RT under rotation. The  
601 lysates were centrifuged at 4°C for 30 min at 10,000g. Glutathione-Sepharose 4B  
602 beads (GE Healthcare) were added to the clarified supernatants and the mixtures  
603 were incubated overnight at 4°C under rotation. The beads were washed with lysis  
604 buffer, three times with 1X phosphate-buffered saline (PBS) and then stored at 4°C  
605 in an equal volume of PBS.

606 For <sup>15</sup>N-labeled P expression, bacteria were grown in minimal medium supplemented  
607 with <sup>15</sup>NH<sub>4</sub>Cl (Eurisotop) as a <sup>15</sup>N source. The GST tag was removed by thrombin  
608 (Millipore) cleavage and the cleaved product exchanged into NMR buffer (50 mM Na  
609 phosphate at pH 6.7, 150 mM NaCl). The quality of protein samples was assessed  
610 by SDS-PAGE. Protein concentration was determined by Bradford assay (Biorad)  
611 and checked by measuring absorbance at 280 nm for fragments containing tyrosine  
612 residues. It is given as protomer concentration in the case of P tetramers.

613

#### 614 **NanoLUC interaction assay**

615 Constructs expressing the NanoLUC subunits 114S and 11S were used (44). 293T  
616 cells were seeded at a concentration of 3x10<sup>4</sup> cells per well in 48-well plate. After 24  
617 h, cells were co-transfected in triplicate with 0.4 µg of total DNA (0.2 µg of each  
618 plasmid) using Lipofectamine 2000 (Invitrogen). 24 h post transfection cells were  
619 washed with PBS, and lysed for 1 h in room temperature using 50 µl NanoLUC lysis  
620 buffer (Promega). NanoLUC enzymatic activity was measured using the NanoLUC  
621 substrate (Promega). For each pair of plasmids, three normalized luminescence

622 ratios (NLRs) were calculated as follows: the luminescence activity measured in cells  
623 transfected with the two plasmids (each viral protein fused to a different NanoLUC  
624 subunit) was divided by the sum of the luminescence activities measured in both  
625 control samples (each NanoLUC fused viral protein transfected with an plasmid  
626 expressing only the NanoLUC subunit) Data represents the mean  $\pm$ SD of 4  
627 independent experiments, each done in triplicate. Luminescence was measured  
628 using Infinite 200 Pro (Tecan, Männedorf, Switzerland).

629

### 630 **NMR spectroscopy**

631 For NMR experiments, P and M solutions were mixed to obtain the desired molar  
632 ratio and concentrated to reach a concentration of 100  $\mu$ M for M (WT and Y229A  
633 mutant).

634 NMR measurements were carried out in a Bruker Avance III spectrometer at a  
635 magnetic field of 18.8 T (800 MHz  $^1$ H frequency) equipped with a cryogenic TCI  
636 probe. The magnetic field was locked with 7 %  $^2$ H $_2$ O. The temperature was set to  
637 288 K or 298 K.  $^1$ H- $^{15}$ N correlation spectra were acquired with a BEST-TROSY  
638 version. Spectra were processed with Topspin 4.0 (Bruker Biospin) and analyzed  
639 with CCPNMR 2.4 (57) software.

640  $^1$ H and  $^{15}$ N amide chemical shift assignment of full-length P and P $_{1-126}$  and P $_{1-163}$   
641 fragments was done previously (46). Amide chemical shift assignment of  $^{15}$ N-labeled  
642 P $_{113-160}$  and of  $^{15}$ N-labeled P $_{120-160}$  was done by recording a  $^{15}$ N-separated NOESY-  
643 HSQC spectrum with 80 ms mixing time. Sequential information was retrieved  
644 through H $_{Ni}$ -H $_{Ni-1}$ , H $_{Ni}$ -H $_{Ni+1}$  and H $_{Ni}$ -H $_{\alpha i-1}$  correlations.

645

### 646 **Virus-like filament/particle formation**

647 Over night cultures of BEAS-2B cells seeded at  $4 \times 10^5$  cells/well in 6-well plates (on a  
648 16-mm micro-cover glass for immunostaining) were transfected with pcDNA3.1  
649 codon-optimized plasmids (0.4  $\mu$ g each) carrying the RSV A2 WT or deletion/mutant  
650 P protein along with pcDNA3.1 codon-optimized plasmids carrying RSV A2 M, N,  
651 and F using Lipofectamine 2000 (Invitrogen) according to the manufacturer's  
652 recommendations. Cells were fixed at 24 h post transfection, immunostained, and  
653 imaged as described below. For VLP formation, over-night cultures of HEp-2 cells  
654 seeded at  $4 \times 10^5$  cells/well in 6-well plates were transfected as described above.  
655 Released VLPs were harvested from the supernatant; the supernatant was clarified  
656 of cell debris by centrifugation (1,300 g, 10 min, 4°C) and pelleted through a 20%  
657 sucrose cushion (13,500 g, 90 min, 4°C). Cells were lysed in radio immune  
658 precipitation assay (RIPA) buffer. Cellular lysates and VLP pellets were dissolved in  
659 Laemmli buffer and subjected to Western analysis.

660

### 661 **Immunostaining and imaging**

662 Cells were fixed with 4% paraformaldehyde in PBS for 10 min, blocked with 3% BSA  
663 in 0.2% Triton X-100–PBS for 10 min, and immunostained with monoclonal anti-M  
664 (1:200; a gift from Mariethe Ehnlund, Karolinska Institute, Sweden), polyclonal anti-N  
665 (1:5000; (30)), polyclonal anti-P (1:500; (30)) or monoclonal anti-P (1:100; a gift from  
666 Jose A. Melero, Madrid, Spain) antibodies, followed by species-specific secondary  
667 antibodies conjugated to Alexa Fluor 488 and Alexa Fluor 568 (1: 1,000; Invitrogen).  
668 Images were obtained using the White Light laser SP8 (Leica Microsystems,  
669 Wetzlar, Germany) confocal microscope at a nominal magnification of 63. Images  
670 were acquired using the Leica Application Suite X (LAS X) software.

671

672 **SDS-PAGE and Western analysis**

673 Protein samples were separated by electrophoresis on 12% polyacrylamide gels in  
674 Tris-glycine buffer. All samples were boiled for 3 min prior to electrophoresis.  
675 Proteins were then transferred to a nitrocellulose membrane (RocheDiagnostics).  
676 The blots were blocked with 5% non fat milk in Tris-buffered saline (pH 7.4), followed  
677 by incubation with rabbit anti-P antiserum (1:5,000) (30), rabbit anti N antiserum  
678 (1:5,000) (30), rabbit anti M antiserum (1:1,000), or rabbit anti M2-1 antiserum  
679 (1:2,000) (30), and horseradish peroxidase (HRP)-conjugated donkey anti-rabbit  
680 (1:5,000) antibodies (P.A.R.I.S.). Western blots were developed using freshly  
681 prepared chemiluminescent substrate (100 mM TrisHCl, pH 8.8, 1.25 mM luminol,  
682 0.2 mM p-coumaric acid, 0.05% H<sub>2</sub>O<sub>2</sub>) and exposed using BIO-RAD ChemiDoc™  
683 Touch Imaging System.

684

685 **Generation of M antiserum**

686 Polyclonal anti M serum was prepared by immunizing a rabbit three times at 2 week  
687 intervals using purified His- fusion proteins (100 mg) for each immunization. The first  
688 and second immunizations were administered subcutaneously in 1 ml Freund's  
689 complete and Freund's incomplete adjuvant (Difco), respectively. The third  
690 immunization was done intramuscularly in Freund's incomplete adjuvant. Animals  
691 were bled 10 days after the third immunization.

692

693 **Native gel**

694 Protein samples were separated by electrophoresis on 1% agarose gel in TBE (Tris  
695 Borate EDTA) buffer. 50 µg M and x 10 µg P were incubated in PBS buffer (pH 7.4)

696 for 20 min in RT. Samples were mixed with 50% sucrose and run for 2 h at 80 V,  
697 following by staining with Amido Black.

698

## 699 **Acknowledgements**

700 We thank Benoit Maury and CYMAGES Imaging facility (Département  
701 biotechnologie Santé, Université Versailles Saint Quentin, France) for their support &  
702 assistance with the confocal imaging. We thank Damien Vitour (E'quipe du  
703 laboratoire d'immunologie de Seppic and the animal facilities, ANSES Maisons-  
704 Alfort) for rabbit immunization with recombinant M. This work was carried out with  
705 the financial support of the French Agence Nationale de la Recherche DecRisP  
706 (ANR-19\_CE11\_0017).

707

708

709

## 710 **References**

711

- 712 1. Group TPERfCHPS. 2019. Causes of severe pneumonia requiring hospital admission in children  
713 without HIV infection from Africa and Asia:  
714 the PERCH multi-country case-control study. *Lancet* 394:757-79.
- 715 2. Grimpel E. 2001. [Epidemiology of infant bronchiolitis in France]. *Arch Pediatr* 8 Suppl 1:83S-92S.
- 716 3. Olszewska W, Openshaw P. 2009. Emerging drugs for respiratory syncytial virus infection. *Expert*  
717 *Opin Emerg Drugs* 14:207-17.
- 718 4. Mazur NI, Higgins D, Nunes MC, Melero JA, Langedijk AC, Horsley N, Buchholz UJ, Openshaw PJ,  
719 McLellan JS, Englund JA, Mejias A, Karron RA, Simoes EA, Knezevic I, Ramilo O, Piedra PA, Chu  
720 HY, Falsey AR, Nair H, Kragten-Tabatabaie L, Greenough A, Baraldi E, Papadopoulos NG,  
721 Vekemans J, Polack FP, Powell M, Satav A, Walsh EE, Stein RT, Graham BS, Bont LJ. 2018. The  
722 respiratory syncytial virus vaccine landscape: lessons from the graveyard and promising  
723 candidates. *Lancet Infect Dis* 18:e295-e311.
- 724 5. Schmidt MR, McGinnes-Cullen LW, Kenward SA, Willems KN, Woodland RT, Morrison TG. 2014.  
725 Modification of the respiratory syncytial virus f protein in virus-like particles impacts generation  
726 of B cell memory. *J Virol* 88:10165-76.
- 727 6. Lee YN, Hwang HS, Kim MC, Lee YT, Lee JS, Moore ML, Kang SM. 2015. Recombinant influenza  
728 virus expressing a fusion protein neutralizing epitope of respiratory syncytial virus (RSV) confers  
729 protection without vaccine-enhanced RSV disease. *Antiviral Res* 115:1-8.
- 730 7. Bachi T, Howe C. 1973. Morphogenesis and ultrastructure of respiratory syncytial virus. *J Virol*  
731 12:1173-80.
- 732 8. Afonso CL, Amarasinghe GK, Banyai K, Bao Y, Basler CF, Bavari S, Bejerman N, Blasdel KR,  
733 Briand FX, Briese T, Bukreyev A, Calisher CH, Chandran K, Cheng J, Clawson AN, Collins PL,

- 734 Dietzgen RG, Dolnik O, Domier LL, Durrwald R, Dye JM, Easton AJ, Ebihara H, Farkas SL, Freitas-  
735 Astua J, Formenty P, Fouchier RA, Fu Y, Ghedin E, Goodin MM, Hewson R, Horie M, Hyndman TH,  
736 Jiang D, Kitajima EW, Kobinger GP, Kondo H, Kurath G, Lamb RA, Lenardon S, Leroy EM, Li CX,  
737 Lin XD, Liu L, Longdon B, Marton S, Maisner A, Muhlberger E, Netesov SV, Nowotny N, et al. 2016.  
738 Taxonomy of the order Mononegavirales: update 2016. *Arch Virol* 161:2351-60.
- 739 9. Rincheval V, Lelek M, Gault E, Bouillier C, Sitterlin D, Blouquit-Laye S, Galloux M, Zimmer C,  
740 Eleouet JF, Rameix-Welti MA. 2017. Functional organization of cytoplasmic inclusion bodies in  
741 cells infected by respiratory syncytial virus. *Nat Commun* 8:563.
- 742 10. Garcia J, Garcia-Barreno B, Vivo A, Melero JA. 1993. Cytoplasmic inclusions of respiratory  
743 syncytial virus-infected cells: formation of inclusion bodies in transfected cells that coexpress  
744 the nucleoprotein, the phosphoprotein, and the 22K protein. *Virology* 195:243-7.
- 745 11. Galloux M, Riso-Ballester J, Richard CA, Fix J, Rameix-Welti MA, Eleouet JF. 2020. Minimal  
746 Elements Required for the Formation of Respiratory Syncytial Virus Cytoplasmic Inclusion Bodies  
747 In Vivo and In Vitro. *MBio* 11.
- 748 12. Roberts SR, Compans RW, Wertz GW. 1995. Respiratory syncytial virus matures at the apical  
749 surfaces of polarized epithelial cells. *J Virol* 69:2667-73.
- 750 13. Bajorek M, Caly L, Tran KC, Maertens GN, Tripp RA, Bacharach E, Teng MN, Ghildyal R, Jans DA.  
751 2014. The Thr205 phosphorylation site within respiratory syncytial virus matrix (M) protein  
752 modulates M oligomerization and virus production. *J Virol* 88:6380-93.
- 753 14. Ke Z, Dillard RS, Chirkova T, Leon F, Stobart CC, Hampton CM, Strauss JD, Rajan D, Rostad CA,  
754 Taylor JV, Yi H, Shah R, Jin M, Hartert TV, Peebles RS, Jr., Graham BS, Moore ML, Anderson LJ,  
755 Wright ER. 2018. The Morphology and Assembly of Respiratory Syncytial Virus Revealed by Cryo-  
756 Electron Tomography. *Viruses* 10.
- 757 15. Vanover D, Smith DV, Blanchard EL, Alonas E, Kirschman JL, Lifland AW, Zurla C, Santangelo PJ.  
758 2017. RSV glycoprotein and genomic RNA dynamics reveal filament assembly prior to the  
759 plasma membrane. *Nat Commun* 8:667.
- 760 16. Blanchard EL, Braun MR, Lifland AW, Ludeke B, Noton SL, Vanover D, Zurla C, Fearn R,  
761 Santangelo PJ. 2020. Polymerase-tagged respiratory syncytial virus reveals a dynamic  
762 rearrangement of the ribonucleocapsid complex during infection. *PLoS Pathog* 16:e1008987.
- 763 17. Meshram CD, Baviskar PS, Ognibene CM, Oomens AG. 2016. The Respiratory Syncytial Virus  
764 Phosphoprotein, Matrix Protein, and Fusion Protein Carboxy-Terminal Domain Drive Efficient  
765 Filamentous Virus-Like Particle Formation. *J Virol* 90:10612-10628.
- 766 18. Shaikh FY, Cox RG, Lifland AW, Hotard AL, Williams JV, Moore ML, Santangelo PJ, Crowe JE, Jr.  
767 2012. A critical phenylalanine residue in the respiratory syncytial virus fusion protein cytoplasmic  
768 tail mediates assembly of internal viral proteins into viral filaments and particles. *MBio* 3.
- 769 19. McLellan JS, Chen M, Leung S, Graepel KW, Du X, Yang Y, Zhou T, Baxa U, Yasuda E, Beaumont  
770 T, Kumar A, Modjarrad K, Zheng Z, Zhao M, Xia N, Kwong PD, Graham BS. 2013. Structure of RSV  
771 fusion glycoprotein trimer bound to a prefusion-specific neutralizing antibody. *Science*  
772 340:1113-7.
- 773 20. McLellan JS, Yang Y, Graham BS, Kwong PD. 2011. Structure of respiratory syncytial virus fusion  
774 glycoprotein in the postfusion conformation reveals preservation of neutralizing epitopes. *J Virol*  
775 85:7788-96.
- 776 21. Swanson KA, Settembre EC, Shaw CA, Dey AK, Rappuoli R, Mandl CW, Dormitzer PR, Carfi A.  
777 2011. Structural basis for immunization with postfusion respiratory syncytial virus fusion F  
778 glycoprotein (RSV F) to elicit high neutralizing antibody titers. *Proc Natl Acad Sci U S A* 108:9619-  
779 24.
- 780 22. Ghildyal R, Ho A, Jans DA. 2006. Central role of the respiratory syncytial virus matrix protein in  
781 infection. *FEMS Microbiol Rev* 30:692-705.
- 782 23. Kiss G, Chen X, Brindley MA, Campbell P, Afonso CL, Ke Z, Holl JM, Guerrero-Ferreira RC, Byrd-  
783 Leotis LA, Steel J, Steinhauer DA, Plemper RK, Kelly DF, Spearman PW, Wright ER. 2014.  
784 Capturing enveloped viruses on affinity grids for downstream cryo-electron microscopy  
785 applications. *Microsc Microanal* 20:164-74.
- 786 24. Harrison MS, Sakaguchi T, Schmitt AP. 2010. Paramyxovirus assembly and budding: building  
787 particles that transmit infections. *Int J Biochem Cell Biol* 42:1416-29.
- 788 25. Mitra R, Baviskar P, Duncan-Decocq RR, Patel D, Oomens AG. 2012. The human respiratory  
789 syncytial virus matrix protein is required for maturation of viral filaments. *J Virol* 86:4432-43.
- 790 26. Ghildyal R, Mills J, Murray M, Vardaxis N, Meanger J. 2002. Respiratory syncytial virus matrix  
791 protein associates with nucleocapsids in infected cells. *J Gen Virol* 83:753-7.
- 792 27. Li D, Jans DA, Bardin PG, Meanger J, Mills J, Ghildyal R. 2008. Association of respiratory syncytial  
793 virus M protein with viral nucleocapsids is mediated by the M2-1 protein. *J Virol* 82:8863-70.
- 794 28. Forster A, Maertens GN, Farrell PJ, Bajorek M. 2015. Dimerization of matrix protein is required for  
795 budding of respiratory syncytial virus. *J Virol* 89:4624-35.



- 796 29. Money VA, McPhee HK, Mosely JA, Sanderson JM, Yeo RP. 2009. Surface features of a  
797 Mononegavirales matrix protein indicate sites of membrane interaction. *Proc Natl Acad Sci U S*  
798 *A* 106:4441-6.
- 799 30. Castagne N, Barbier A, Bernard J, Rezaei H, Huet JC, Henry C, Da Costa B, Eleouet JF. 2004.  
800 Biochemical characterization of the respiratory syncytial virus P-P and P-N protein complexes  
801 and localization of the P protein oligomerization domain. *J Gen Virol* 85:1643-53.
- 802 31. Lorente MT, Taylor IA, Lopez-Vinas E, Gomez-Puertas P, Calder LJ, Garcia-Barreno B, Melero JA.  
803 2008. Structural properties of the human respiratory syncytial virus P protein: evidence for an  
804 elongated homotetrameric molecule that is the smallest orthologue within the family of  
805 paramyxovirus polymerase cofactors. *Proteins* 72:946-58.
- 806 32. Gilman MSA, Liu C, Fung A, Behera I, Jordan P, Rigaux P, Ysebaert N, Tcherniuk S, Sourimant J,  
807 Eleouet JF, Sutto-Ortiz P, Decroly E, Roymans D, Jin Z, McLellan JS. 2019. Structure of the  
808 Respiratory Syncytial Virus Polymerase Complex. *Cell* 179:193-204 e14.
- 809 33. Simabuco FM, Asara JM, Guerrero MC, Libermann TA, Zerbini LF, Ventura AM. 2011. Structural  
810 analysis of human respiratory syncytial virus p protein: identification of intrinsically disordered  
811 domains. *Braz J Microbiol* 42:340-5.
- 812 34. Noval MG, Esperante SA, Molina IG, Chemes LB, Prat-Gay G. 2016. Intrinsic Disorder to Order  
813 Transitions in the Scaffold Phosphoprotein P from the Respiratory Syncytial Virus RNA Polymerase  
814 Complex. *Biochemistry* 55:1441-54.
- 815 35. Pereira N, Cardone C, Lassoued S, Galloux M, Fix J, Assrir N, Lescop E, Bontems F, Eleouet JF,  
816 Sizon C. 2017. New Insights into Structural Disorder in Human Respiratory Syncytial Virus  
817 Phosphoprotein and Implications for Binding of Protein Partners. *J Biol Chem* 292:2120-2131.
- 818 36. Galloux M, Gabiane G, Sourimant J, Richard CA, England P, Moudjou M, Aumont-Nicaise M, Fix  
819 J, Rameix-Welti MA, Eleouet JF. 2015. Identification and characterization of the binding site of  
820 the respiratory syncytial virus phosphoprotein to RNA-free nucleoprotein. *J Virol* 89:3484-96.
- 821 37. Tran TL, Castagne N, Bhella D, Varela PF, Bernard J, Chilmonec S, Berkenkamp S, Benhamo V,  
822 Grznarova K, Grosclaude J, Nespoulos C, Rey FA, Eleouet JF. 2007. The nine C-terminal amino  
823 acids of the respiratory syncytial virus protein P are necessary and sufficient for binding to  
824 ribonucleoprotein complexes in which six ribonucleotides are contacted per N protein  
825 protomer. *J Gen Virol* 88:196-206.
- 826 38. Sourimant J, Rameix-Welti MA, Gaillard AL, Chevret D, Galloux M, Gault E, Eleouet JF. 2015. Fine  
827 mapping and characterization of the L-polymerase-binding domain of the respiratory syncytial  
828 virus phosphoprotein. *J Virol* 89:4421-33.
- 829 39. Cao D, Gao Y, Roesler C, Rice S, D'Cunha P, Zhuang L, Slack J, Domke M, Antonova A,  
830 Romanelli S, Keating S, Forero G, Juneja P, Liang B. 2020. Cryo-EM structure of the respiratory  
831 syncytial virus RNA polymerase. *Nat Commun* 11:368.
- 832 40. Selvaraj M, Yegambaram K, Todd E, Richard CA, Dods RL, Pangratiou GM, Trinh CH, Moul SL,  
833 Murphy JC, Mankouri J, Eleouet JF, Barr JN, Edwards TA. 2018. The Structure of the Human  
834 Respiratory Syncytial Virus M2-1 Protein Bound to the Interaction Domain of the Phosphoprotein  
835 P Defines the Orientation of the Complex. *MBio* 9.
- 836 41. Richard CA, Rincheval V, Lassoued S, Fix J, Cardone C, Esneau C, Nekhai S, Galloux M, Rameix-  
837 Welti MA, Sizon C, Eleouet JF. 2018. RSV hijacks cellular protein phosphatase 1 to regulate M2-1  
838 phosphorylation and viral transcription. *PLoS Pathog* 14:e1006920.
- 839 42. Meshram CD, Oomens AGP. 2019. Identification of a human respiratory syncytial virus  
840 phosphoprotein domain required for virus-like-particle formation. *Virology* 532:48-54.
- 841 43. Lu B, Ma CH, Brazas R, Jin H. 2002. The major phosphorylation sites of the respiratory syncytial  
842 virus phosphoprotein are dispensable for virus replication in vitro. *J Virol* 76:10776-84.
- 843 44. Dixon AS, Schwinn MK, Hall MP, Zimmerman K, Otto P, Lubben TH, Butler BL, Binkowski BF,  
844 Machleidt T, Kirkland TA, Wood MG, Eggers CT, Encell LP, Wood KV. 2016. NanoLuc  
845 Complementation Reporter Optimized for Accurate Measurement of Protein Interactions in  
846 Cells. *ACS Chem Biol* 11:400-8.
- 847 45. Galloux M, Tarus B, Blazevic I, Fix J, Duquerroy S, Eleouet JF. 2012. Characterization of a viral  
848 phosphoprotein binding site on the surface of the respiratory syncytial nucleoprotein. *J Virol*  
849 86:8375-87.
- 850 46. Pereira N, Cardone C, Lassoued S, Galloux M, Fix J, Assrir N, Lescop E, Bontems F, Eleouet JF,  
851 Sizon C. 2017. New Insights into Structural Disorder in Human Respiratory Syncytial Virus  
852 Phosphoprotein and Implications for Binding of Protein Partners. *The Journal of biological*  
853 *chemistry* 292:2120-2131.
- 854 47. Richard CA, Rincheval V, Lassoued S, Fix J, Cardone C, Esneau C, Nekhai S, Galloux M, Rameix-  
855 Welti MA, Sizon C, Eleouet JF. 2018. RSV hijacks cellular protein phosphatase 1 to regulate M2-1  
856 phosphorylation and viral transcription. *PLoS Pathogens* 14:e1006920.



- 857 48. Ray G, Schmitt PT, Schmitt AP. 2016. C-Terminal DxD-Containing Sequences within  
858 Paramyxovirus Nucleocapsid Proteins Determine Matrix Protein Compatibility and Can Direct  
859 Foreign Proteins into Budding Particles. *J Virol* 90:3650-60.
- 860 49. Kipper S, Hamad S, Caly L, Avrahami D, Bacharach E, Jans DA, Gerber D, Bajorek M. 2015. New  
861 host factors important for respiratory syncytial virus (RSV) replication revealed by a novel  
862 microfluidics screen for interactors of matrix (M) protein. *Mol Cell Proteomics* 14:532-43.
- 863 50. Kiss G, Holl JM, Williams GM, Alonas E, Vanover D, Lifland AW, Gudheti M, Guerrero-Ferreira RC,  
864 Nair V, Yi H, Graham BS, Santangelo PJ, Wright ER. 2014. Structural analysis of respiratory  
865 syncytial virus reveals the position of M2-1 between the matrix protein and the  
866 ribonucleoprotein complex. *J Virol* 88:7602-17.
- 867 51. Liljeroos L, Krzyzaniak MA, Helenius A, Butcher SJ. 2013. Architecture of respiratory syncytial virus  
868 revealed by electron cryotomography. *Proc Natl Acad Sci U S A* 110:11133-8.
- 869 52. Fearn R, Collins PL. 1999. Role of the M2-1 transcription antitermination protein of respiratory  
870 syncytial virus in sequential transcription. *J Virol* 73:5852-64.
- 871 53. Blondot ML, Dubosclard V, Fix J, Lassoued S, Aumont-Nicaise M, Bontems F, Eleouet JF, Sizun C.  
872 2012. Structure and functional analysis of the RNA- and viral phosphoprotein-binding domain of  
873 respiratory syncytial virus M2-1 protein. *PLoS Pathog* 8:e1002734.
- 874 54. Asenjo A, Calvo E, Villanueva N. 2006. Phosphorylation of human respiratory syncytial virus P  
875 protein at threonine 108 controls its interaction with the M2-1 protein in the viral RNA  
876 polymerase complex. *J Gen Virol* 87:3637-42.
- 877 55. Lambert DM, Hambor J, Diebold M, Galinski B. 1988. Kinetics of synthesis and phosphorylation of  
878 respiratory syncytial virus polypeptides. *J Gen Virol* 69 ( Pt 2):313-23.
- 879 56. Hotard AL, Shaikh FY, Lee S, Yan D, Teng MN, Plemper RK, Crowe JE, Jr., Moore ML. 2012. A  
880 stabilized respiratory syncytial virus reverse genetics system amenable to recombination-  
881 mediated mutagenesis. *Virology* 434:129-36.
- 882 57. Vranken WF, Boucher W, Stevens TJ, Fogh RH, Pajon A, Llinas M, Ulrich EL, Markley JL, Ionides J,  
883 Laue ED. 2005. The CCPN data model for NMR spectroscopy: development of a software  
884 pipeline. *Proteins* 59:687-96.
- 885 58. Notredame C, Higgins DG, Heringa J. 2000. T-Coffee: A novel method for fast and accurate  
886 multiple sequence alignment. *J Mol Biol* 302:205-17.
- 887 59. Pan J, Qian X, Lattmann S, El Sahili A, Yeo TH, Jia H, Cressey T, Ludeke B, Noton S, Kalocsay M,  
888 Fearn R, Lescar J. 2020. Structure of the human metapneumovirus polymerase phosphoprotein  
889 complex. *Nature* 577:275-279.

890

891

## 892 **Figure legends**

### 893 **Fig.1: Specific localization of M depends on expression of F, P, and N proteins.**

894 BEAS-2B cells were co-transfected with pcDNA3.1 plasmids expressing RSV M, P,  
895 N, and F or a different combination of three proteins. 24 h post-transfection, cells  
896 were fixed, and immunostained with **(A)** anti-M (green) and anti-N (red) or **(B)** anti-P  
897 (green) and anti-N (red) primary antibodies followed by Alexa Fluor secondary  
898 antibodies, and were analyzed by confocal microscopy. Scale bars represent 10µm.  
899 Merged images are zoomed in 3X.

900

901

902 **Fig. 2: M interacts with P in cells.** Protein-protein interactions were measured  
903 using the NanoLuc assay. **(A)** Scheme of the RSV protein constructs fused with  
904 NanoLUC 114 or 11S subunit and pair combinations used in (C). **(B)** 293T cells were  
905 transfected with plasmids encoding P, N, M, or M2-1 fused to 114 or 11S NanoLUC  
906 subunit. Cells were lysed 24 h post transfection, and cell lysates were then subjected  
907 to Western analysis using anti-P, anti-M, anti-N or anti-M2-1 polyclonal antibody.  
908 Size markers are shown on the left side of each gel. **(C)** 293T cells were transfected  
909 with pairs of constructs, combined as shown in the graph. P/P and P/N were used as  
910 positive controls. Cells were lysed 24 h post transfection, and luminescence was  
911 measured using a Tecan Infinite 200 plate reader. The NLR is the ratio between  
912 actual read and negative controls (each protein with the empty NanoLUC vector).  
913 The graph is representative of four independent experiments, each done in three  
914 technical repeats. Data represents the means and error bars represent standard  
915 deviation across 4 independent biological replicates.

916

917 **Fig. 3: M directly interacts with P via its N-terminal region and OD.** **A.** Scheme  
918 of the secondary structure of P protein ( $\alpha_{N1}$ ,  $\alpha_{N2}$ ,  $\alpha_{C1}$  and  $\alpha_{C2}$  denote transient helices  
919 detected in isolated P (35)) and the P constructs used. P<sub>1-163</sub> and P<sub>1-161</sub> constructs  
920 were used for bacterial and mammalian expression, respectively. **B.** SDS-PAGE and  
921 Coomassie blue staining of purified recombinant M, P and P fragments. **C.** M protein  
922 was co-incubated with P or P fragments for 30 min prior analysis of formation of  
923 complexes by band shift on native agarose gel. Arrows indicate complex formation.  
924 **D.** BEAS-2B cells were co-transfected with pcDNA3.1 plasmids expressing RSV M,  
925 F, N, and P WT or P deletion mutants. Cells were fixed, and immunostained with  
926 anti-M (green) and anti-P (red) antibodies followed by Alexa Fluor secondary

927 antibodies, and were analyzed by confocal microscopy. Scale bars represent 10 $\mu$ m.  
928 Merged images are zoomed in 3X.

929

930 **Fig. 4: Observation of a direct interaction between RSV P1-163 and M-Y229A**

931 **mutant by NMR. A.** Superimposed 2D  $^1\text{H}$ - $^{15}\text{N}$  BEST-TROSY HSQC spectra and **B.** 1D

932  $^1\text{H}$  spectra with water suppression of 25  $\mu\text{M}$   $^{15}\text{N}$ -labeled P<sub>1-163</sub> alone (red) and with 4

933 molar equivalents of M-Y229A (black). Acquisition was done in 50 mM Na phosphate

934 pH 6.7, 150 mM NaCl buffer at 800 MHz  $^1\text{H}$  frequency and a temperature of 288 K.

935 Residue-specific assignment of each 2D peak is indicated by the P residue number and

936 the amino acid type. Signals with significant intensity decrease are annotated in colour.

937 Arrows indicate specific M  $^1\text{H}$  NMR signals, in methyl (-1-1 ppm) and aromatic (6-7

938 ppm) proton regions. **C.** Intensity ratios ( $I/I_0$ ), represented as bar diagrams, were

939 measured for each peak in the HSQC spectra of 25  $\mu\text{M}$   $^{15}\text{N}$ -labeled P<sub>1-163</sub> in the

940 absence and in presence of M-Y229A, at P:M molar ratios of 1:2 and 1:4. Signals from

941 the  $\alpha$ -helical oligomerization domain ( $\alpha_{\text{OD}}$ , hatched area) are broadened beyond

942 detection. Coloured background indicates the localization of P specific regions:

943 transient helices  $\alpha_{\text{N1}}$ ,  $\alpha_{\text{N2}}$  (also termed site I), extended region  $\beta_{\text{N}}$  and site II upstream of

944  $\alpha_{\text{OD}}$ . **D.** Intensity ratios ( $I/I_0$ ) measured from HSQC spectra of 40  $\mu\text{M}$  P<sub>1-163</sub> in the

945 absence and in the presence of 150  $\mu\text{M}$  M-Y229A, using two different salt

946 concentrations, 150 mM and 300 mM, as indicated.

947

948 **Fig. 5: Localisation of RSV M-Y229A interaction regions on P by NMR using**

949 **fragments of P<sub>1-163</sub>.** Superimposed 2D  $^1\text{H}$ - $^{15}\text{N}$  BEST-TROSY HSQC spectra of  $^{15}\text{N}$ -

950 labeled N-terminal P fragments. Samples were in 50 mM Na phosphate pH 6.7 150

951 mM NaCl buffer. Spectra were recorded at 800 MHz  $^1\text{H}$  frequency. **A.** 25  $\mu\text{M}$   $^{15}\text{N}$ -

952 labeled P<sub>1-126</sub> alone (green) and after addition of 4 molar equivalents of M-Y229A  
953 (black) at a temperature of 288 K, **B.** 50  $\mu$ M <sup>15</sup>N-labeled P<sub>113-163</sub> alone (pink) and with  
954 2 molar equivalents of M-Y229A (black), at 288 K and 298 K, **C.** 25  $\mu$ M <sup>15</sup>N-labeled  
955 P<sub>120-160</sub> alone (blue) and in the presence of 2 molar equivalents of M-Y229A (black),  
956 at 288 K. **D.** Intensity ratios (I/I<sub>0</sub>) were determined from the HSQC spectra of P<sub>1-126</sub>  
957 and P<sub>113-163</sub> with and without M-Y229A. Signals from the OD ( $\alpha_{OD}$ , hatched area),  
958 which are broadened beyond detection at 288K for P<sub>113-163</sub>, become visible at 298 K.  
959 Other areas are highlighted using the same colour code as in Fig. 4.

960

961 **Fig. 6: Validation of novel M-binding sites on P using P deletion mutants. A.**  
962 Scheme of the P protein secondary structure and the P constructs used. **B.** His-  
963 tagged and size-exclusion chromatography purified M, P or P fragments purified on  
964 glutathione beads were analysed using SDS-PAGE and Coomassie Blue staining. **C.**  
965 Purified M WT (upper panel) or M Y229A (lower panel), and P or P deletion  
966 constructs were incubated 30 min prior analysis of formation of complexes by band  
967 shift on native agarose gel. Arrows indicate complex formation. **D.** 293T cells were  
968 transfected with pairs of M and P constructs fused to 114 or 11S NanoLUC subunit,  
969 combined as shown in the graph. P/P was used as positive control. Cells were lysed  
970 24 h post transfection, and luminescence was measured using a Tecan Infinite 200  
971 plate reader. The NLR is the ratio between actual read and negative controls (each  
972 protein with the empty NanoLUC vector). The graph is representative of four  
973 independent experiments, each done in three technical repeats. Data represents the  
974 means and error bars represent standard deviation across 4 independent biological  
975 replicates.

976 **E.** Same cellular lysates used in D. were then subjected to Western analysis using  
977 anti-P or anti-M polyclonal antibody. Size markers are shown on the left side of each  
978 gel.

979

980 **Fig. 7: Functional analysis of P regions displaying direct M-binding. A.** Scheme  
981 of the P protein secondary structure and the P constructs used. **B.** BEAS-2B cells  
982 were co-transfected with pcDNA3.1 plasmids expressing RSV M, N, F and P deletion  
983 mutants. Cells were fixed, permeabilized at 24 h post transfection, immunostained  
984 with anti-M and anti-P primary antibodies followed by Alexa Fluor secondary  
985 antibodies, and were analysed by confocal microscopy. Scale bars represent 10  $\mu$ m.  
986 Merged images are zoomed in 3X. **C.** HEp-2 cells were co-transfected with  
987 pcDNA3.1 plasmids expressing RSV M, F and P<sub>WT</sub> (lane 1, positive control) or  
988 pcDNA3.1 plasmids carrying RSV M, F and an empty pcDNA3.1 vector (lane 2,  
989 negative control) or with the indicated RSV P mutant constructs (lanes 3 to 8). At 48  
990 h post transfection, VLPs (top) were isolated from the supernatant by pelleting of the  
991 clean supernatant through a sucrose cushion. Cell lysates (bottom) were generated  
992 using RIPA buffer. VLPs and cell lysates were then subjected to Western analysis  
993 using anti-P or anti-M polyclonal antibody. The amount of M and P protein in VLPs  
994 was quantified using the ImageJ software, and is presented as percentage (%) of M  
995 and P protein released when P<sub>WT</sub> was used (100%). The graph is representative of  
996 four independent experiments. Data represents the % means and error bars  
997 represent standard deviation across 4 independent biological replicates.

998

999 **Fig. 8: Sequence alignment of the central part of *Pneumoviridae***  
1000 **phosphoproteins.** Sequence alignment for human (strains A and B), bovine and

1001 ovine respiratory syncytial virus, murine pneumonia virus, human and avian  
1002 metapneumovirus P proteins was generated using T-coffee suite of program (58).  
1003 Uniprot accession numbers are indicated next to each sequence and residue  
1004 numbers are given for each sequence. Complete conservation is indicated with a  
1005 white font on red background, and relative conservation is indicated by a red font.  
1006 Conserved motifs and structure elements are annotated for hRSV P and boxed  
1007 throughout the aligned sequences. The boundaries of the OD are from the cryo-EM  
1008 structures of L-P complexes of hRSV and hMPV (32, 59). The “RVxF”-like motif that  
1009 binds PP1 and the  $\alpha_{N2}$  M2-1 binding site (41) are boxed in green and magenta,  
1010 respectively. M binding sites I and M binding site II, as identified by NMR, are  
1011 indicated or boxed in blue, respectively. Identified phosphorylation sites in the hRSV  
1012 P (43, 54) are indicated by a star above the sequence.

1013



Fig. 1A

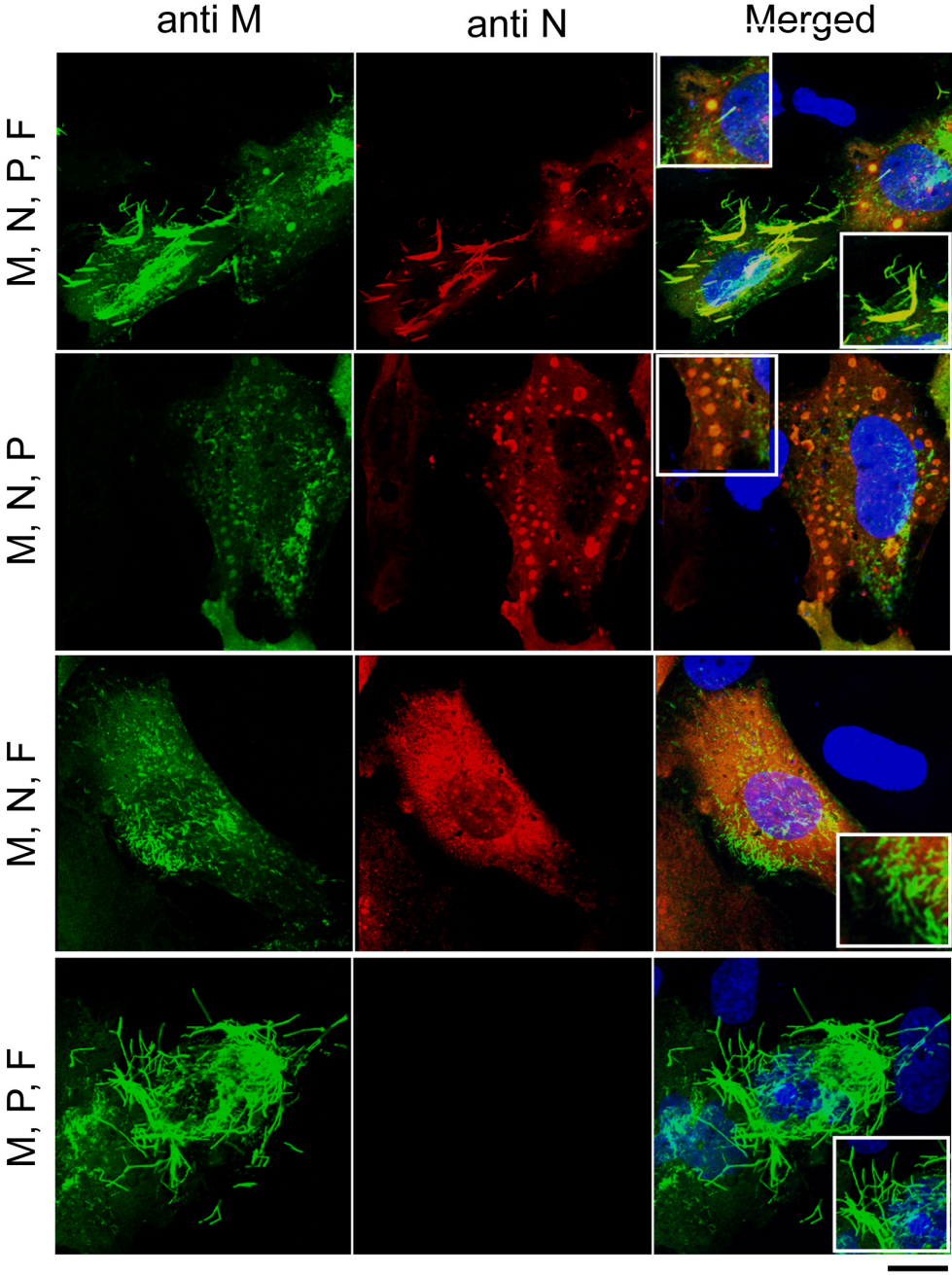
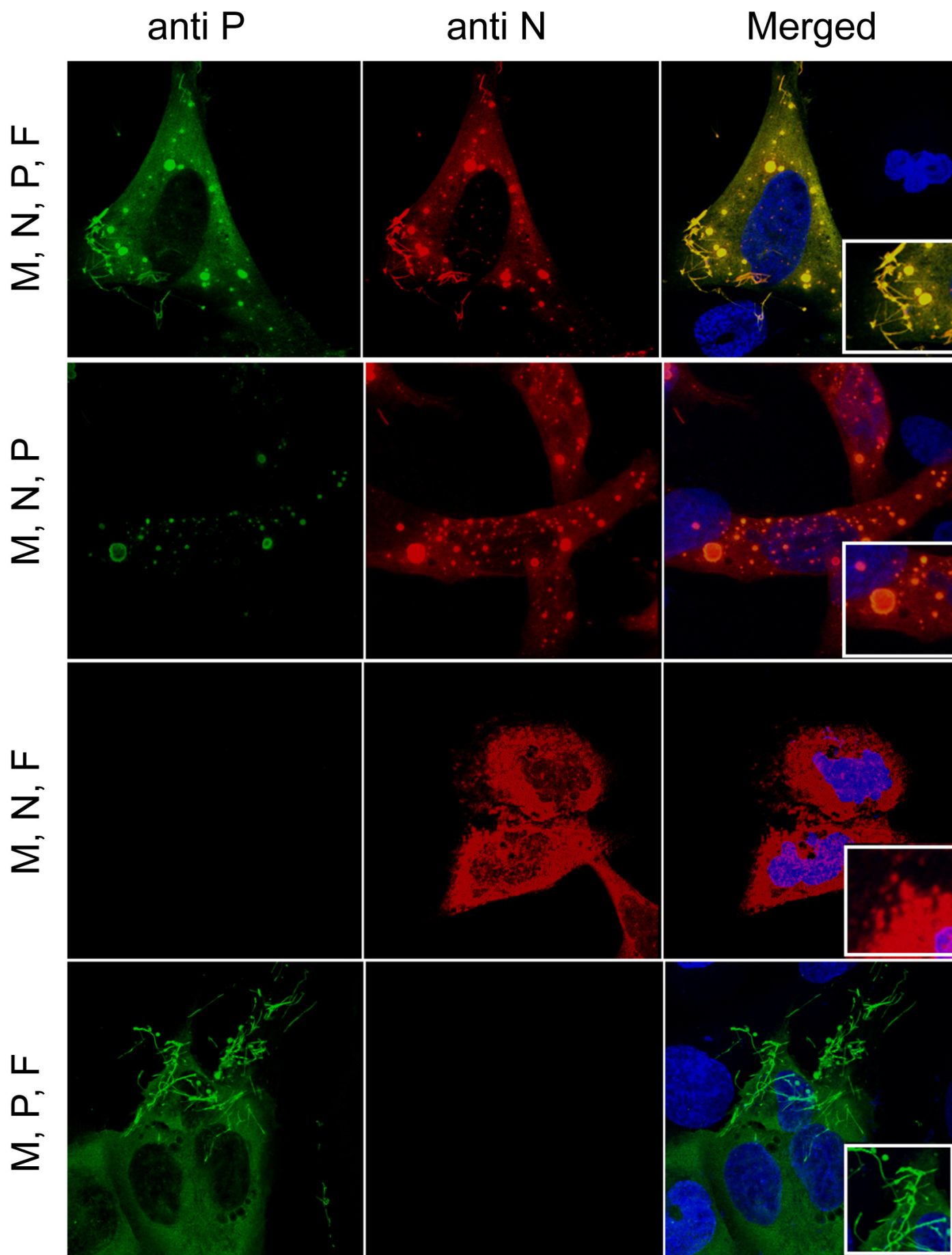

Fig. 1B





# Fig. 2

## A.

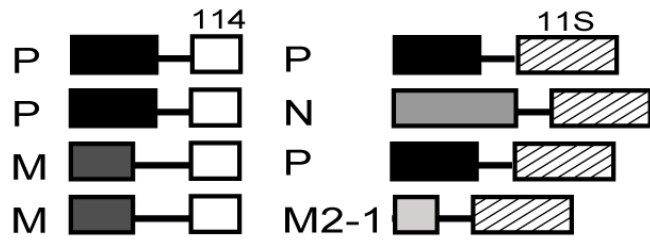

## B.

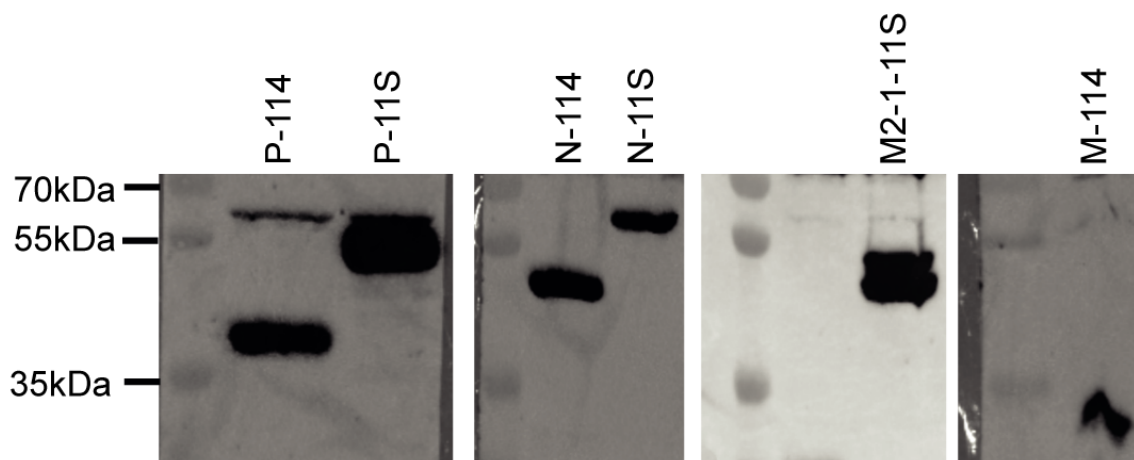

## C.

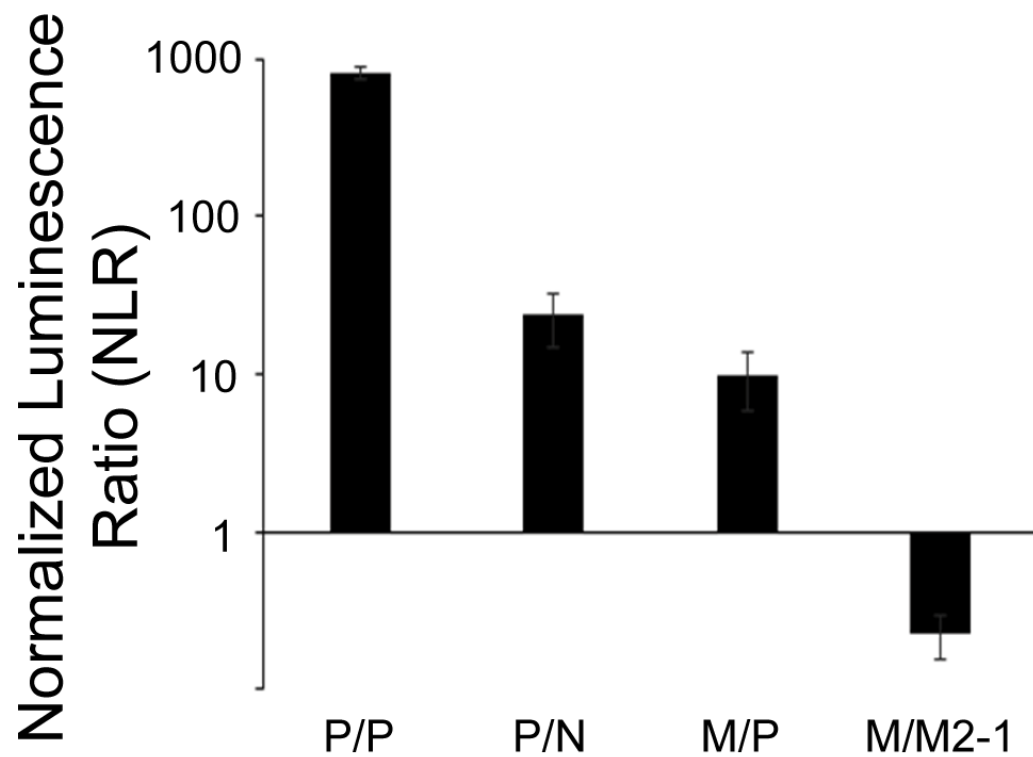

# Fig. 3

## A.

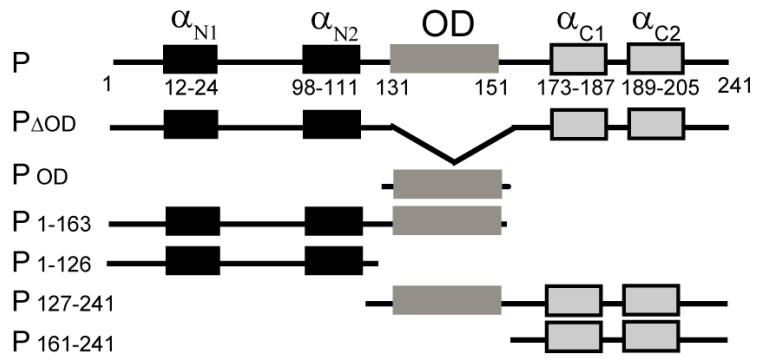

## B.

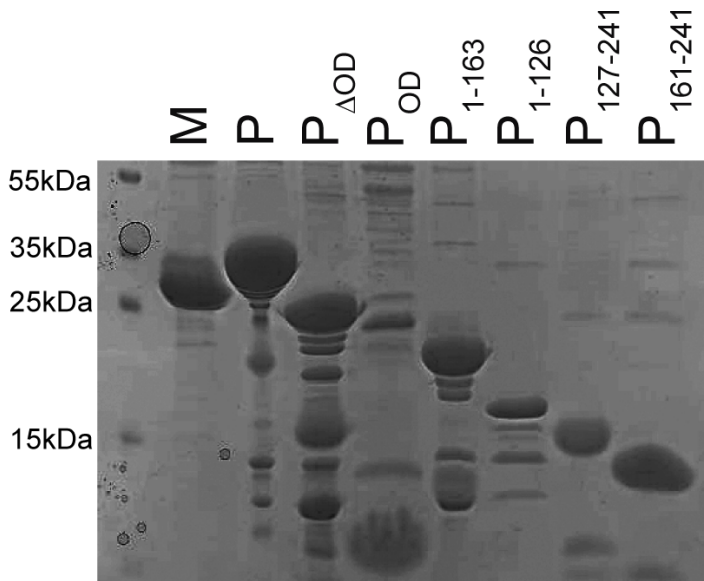

## C.

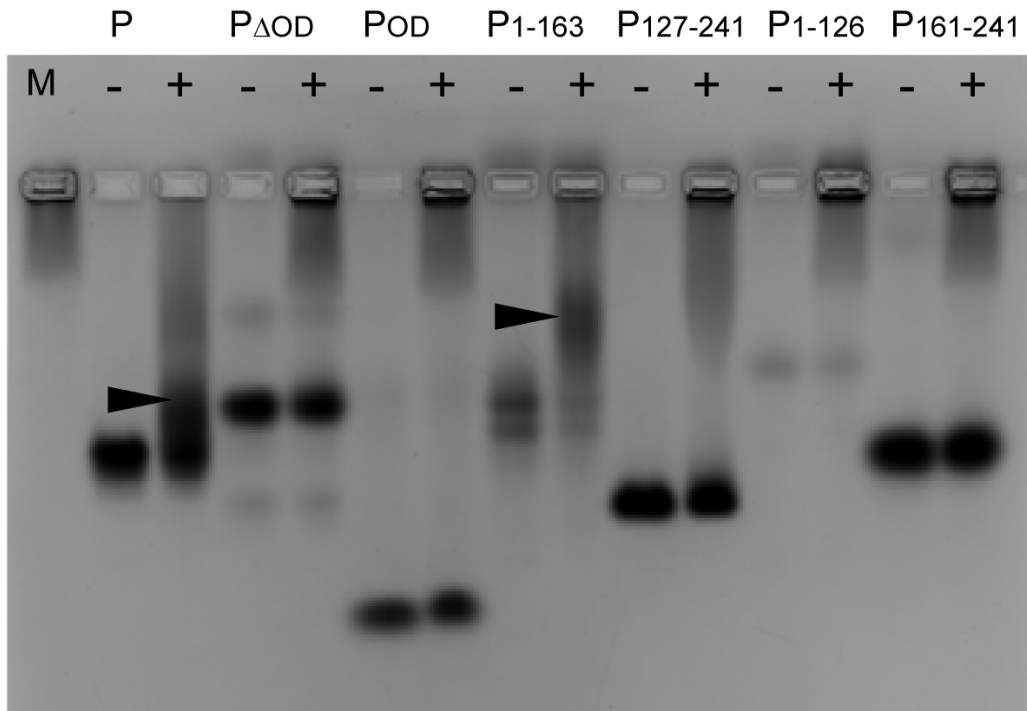

Fig. 3D

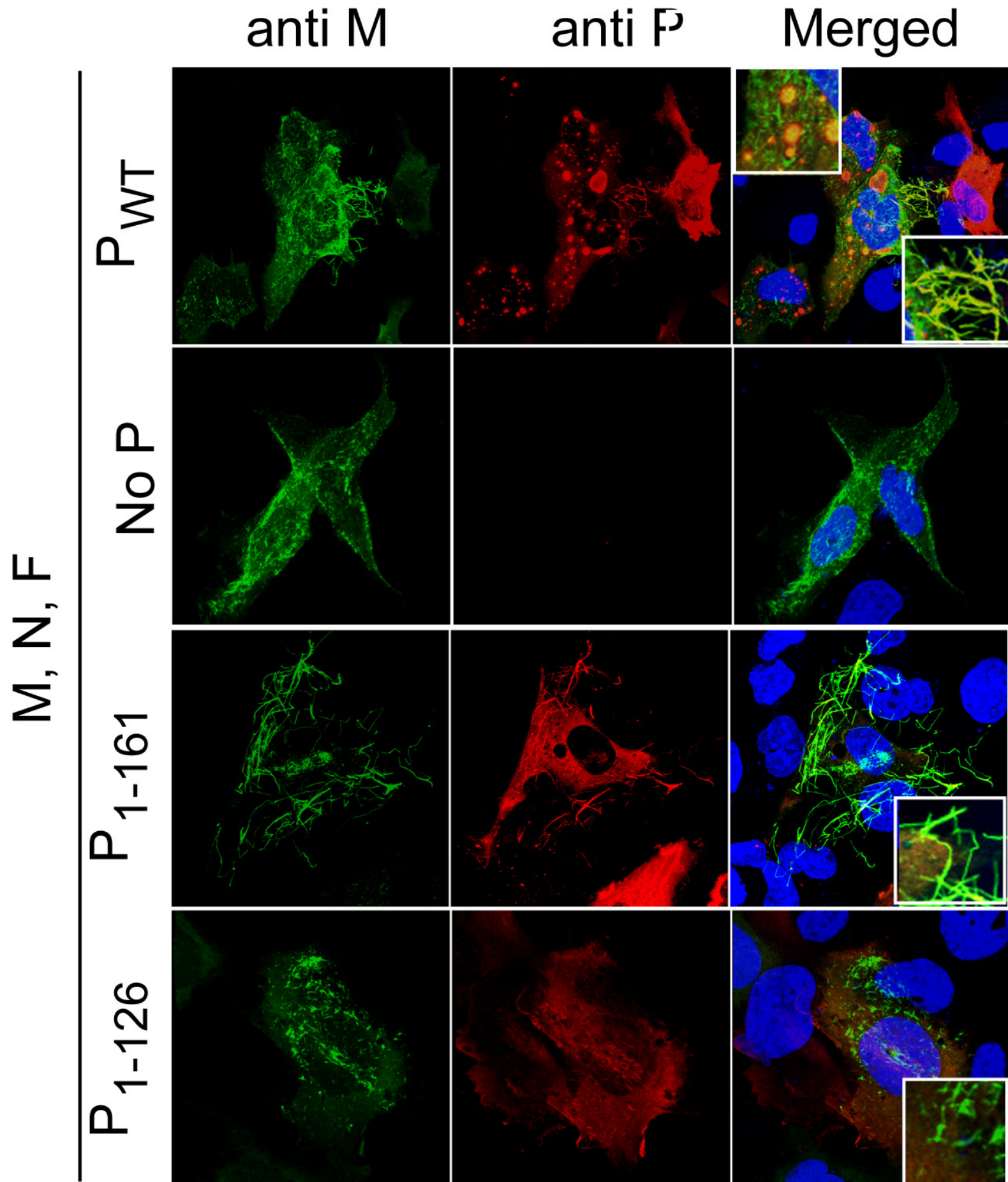

Fig. 4

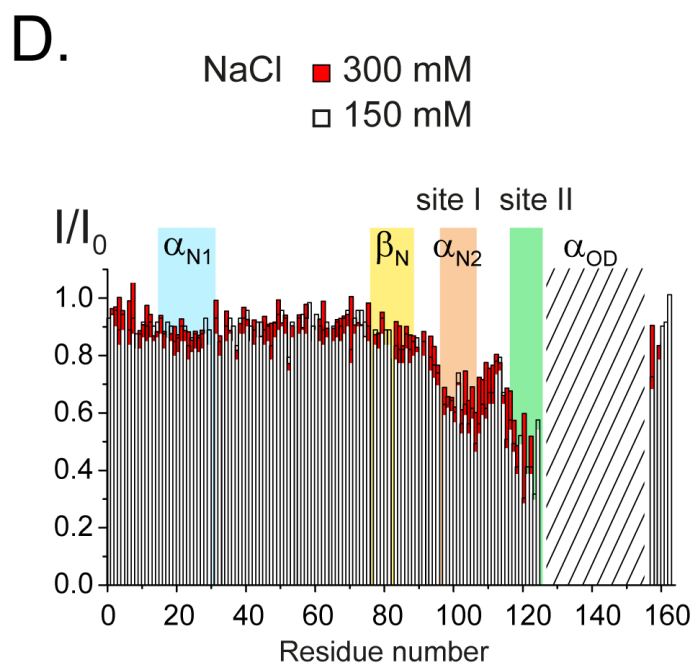
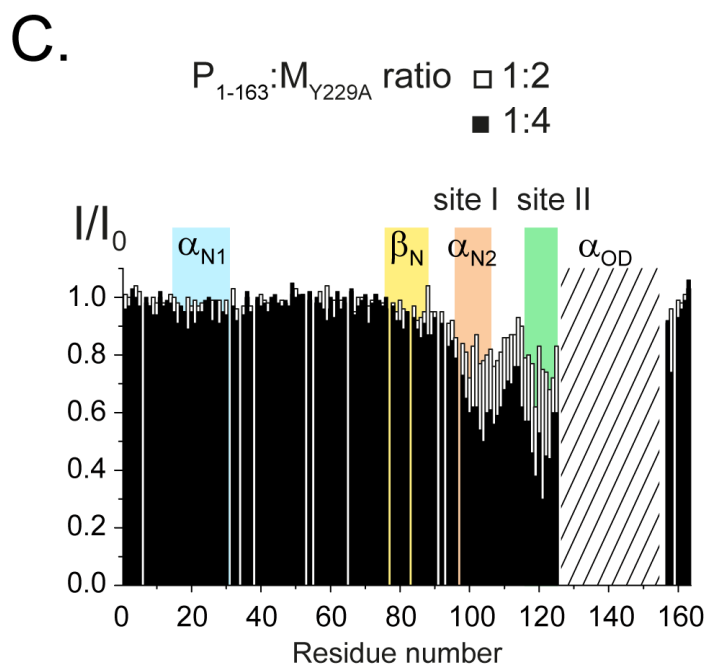
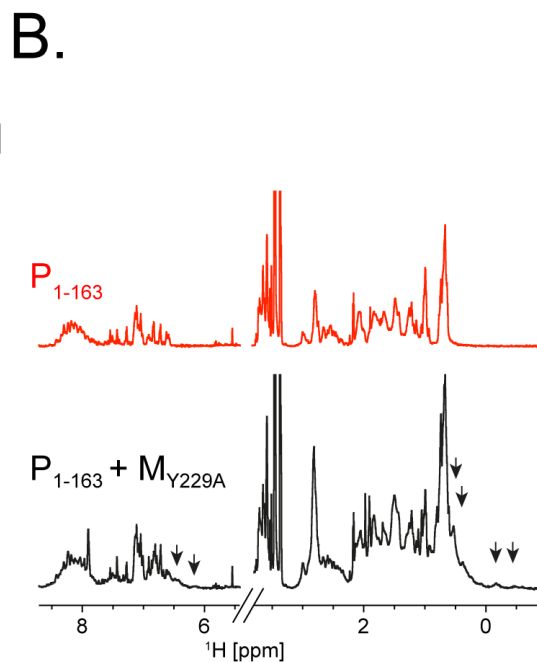
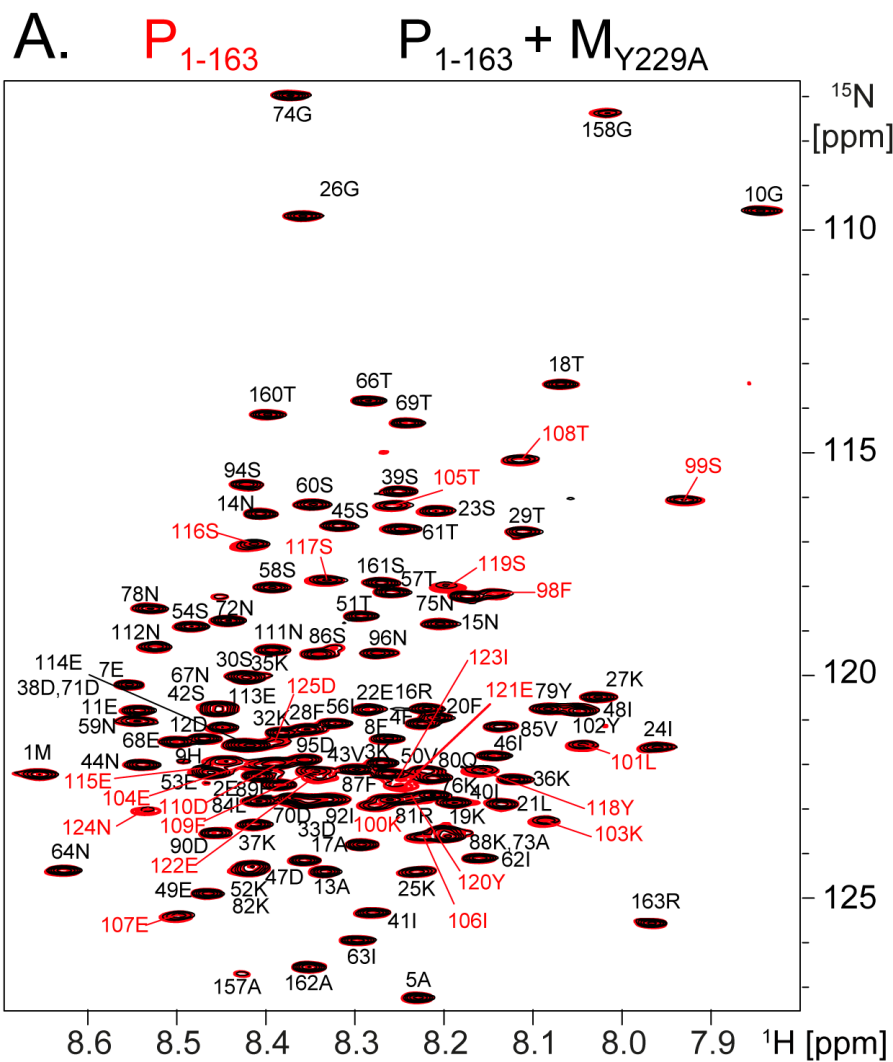
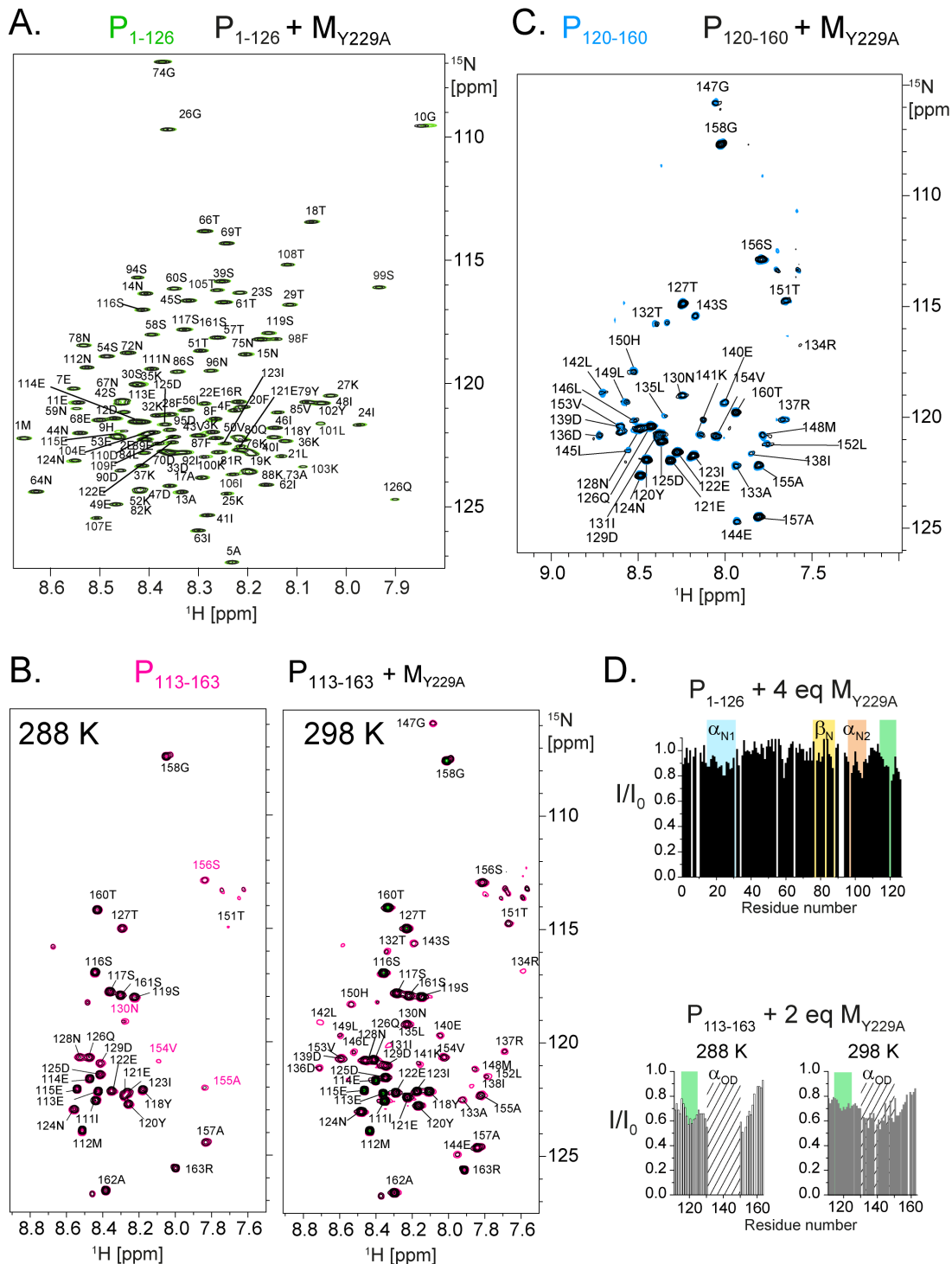

Fig. 5





**Fig. 6****A.****B.****C.****D.****E.**

Fig. 7





# Fig. 8

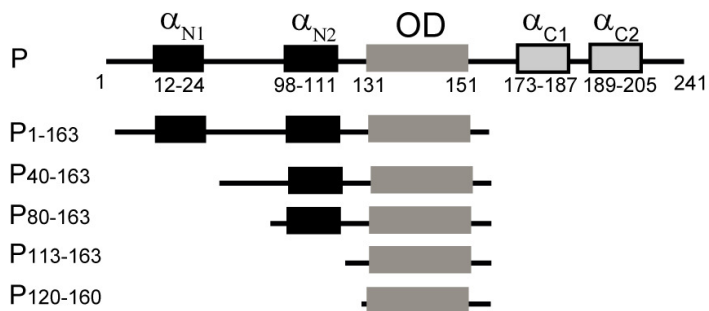
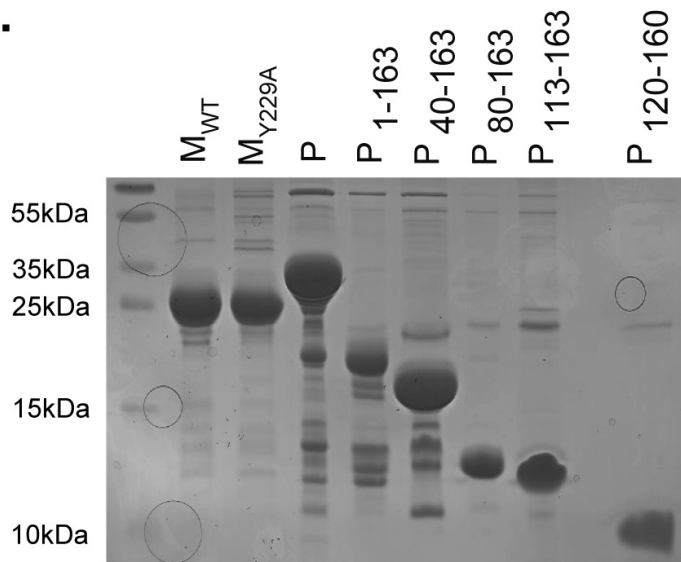
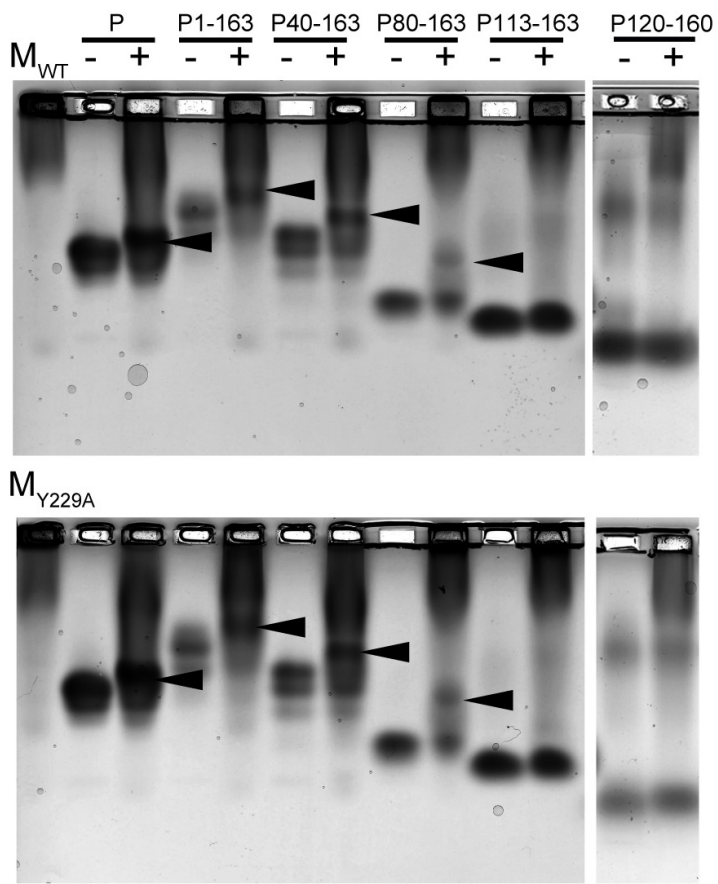
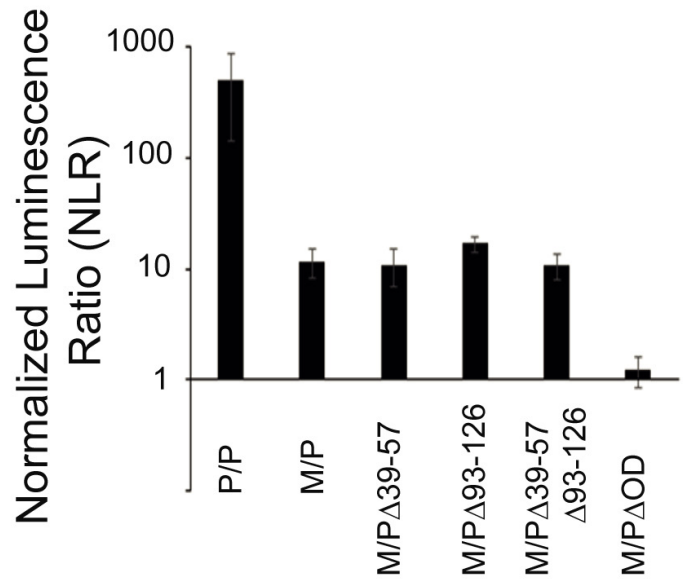
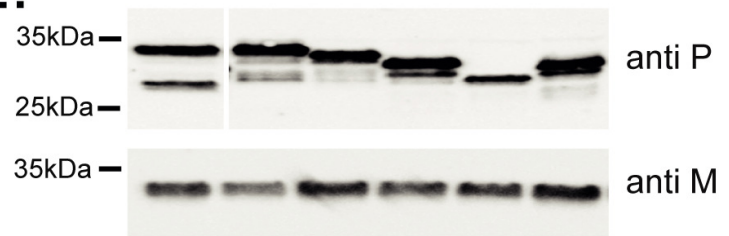
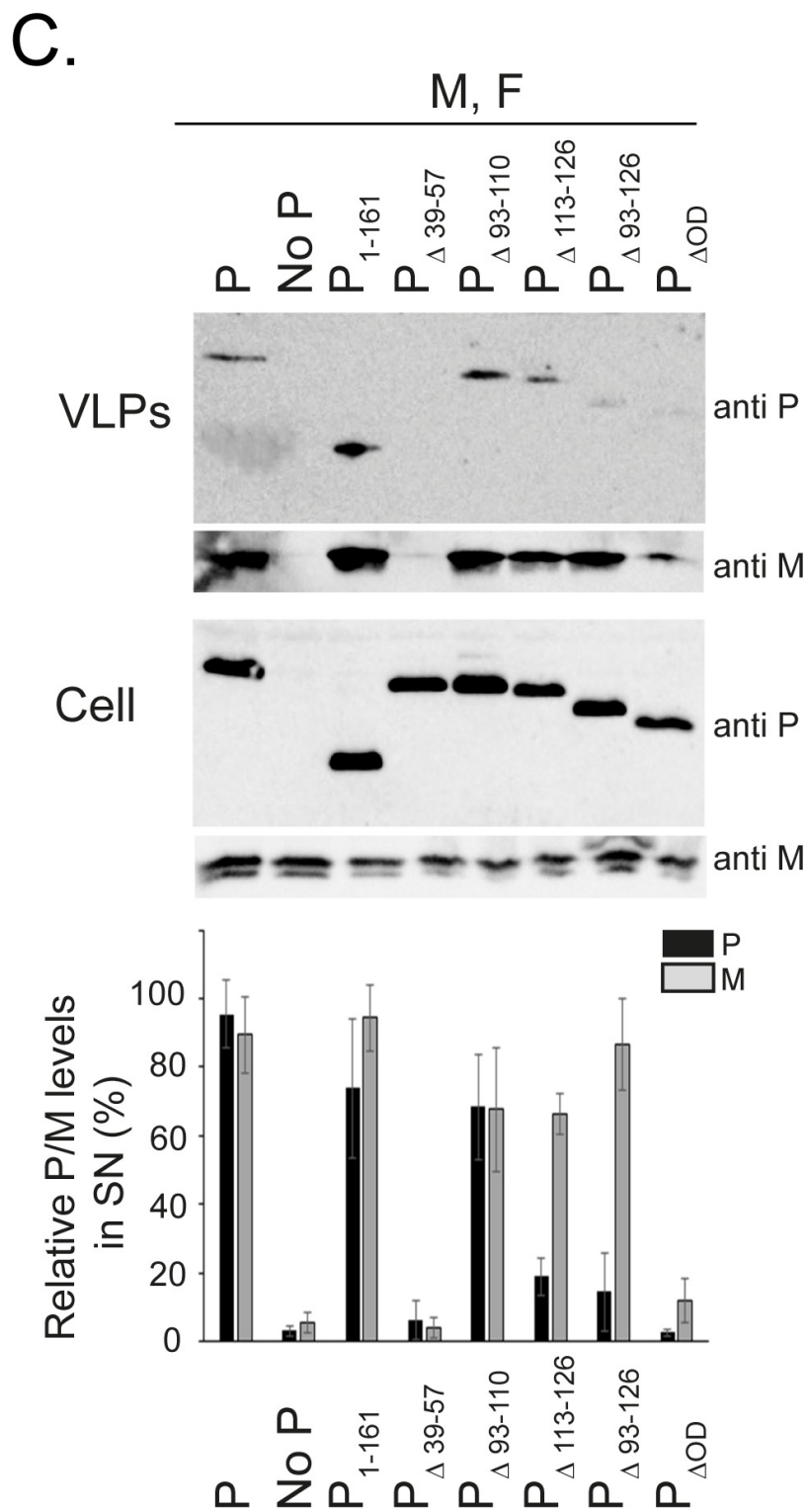
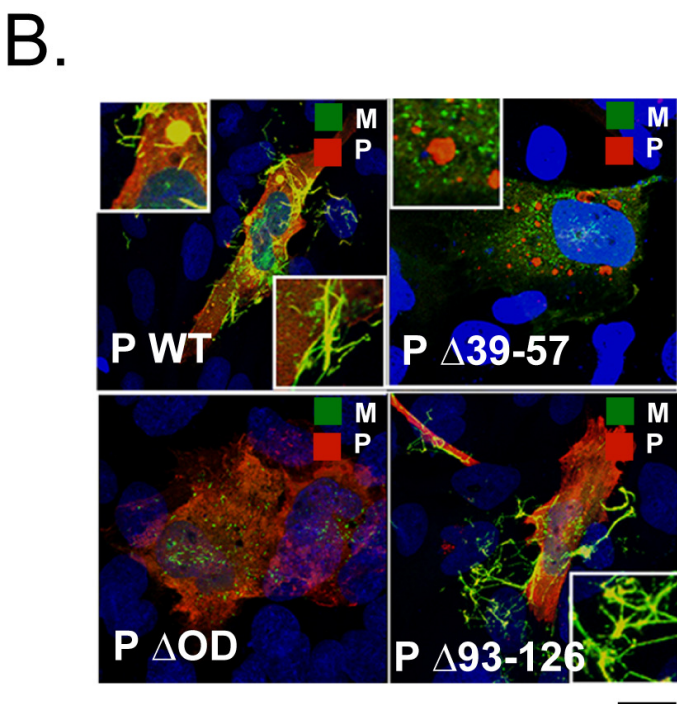
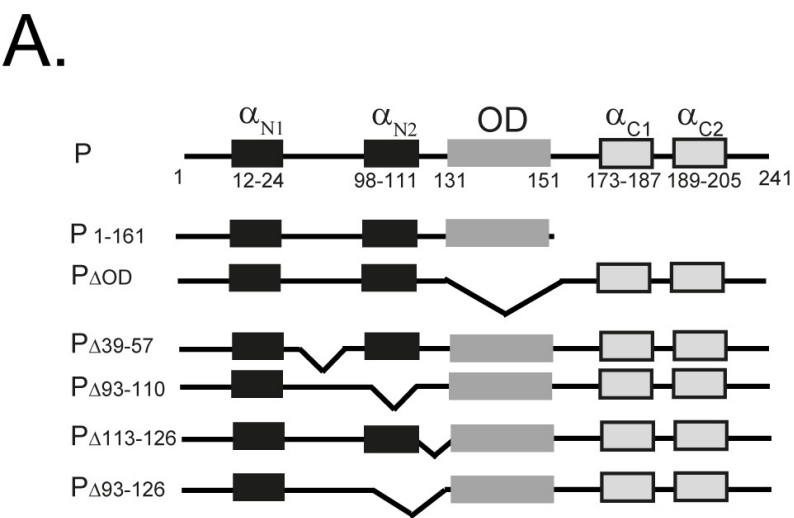