



HAL
open science

Autonomous assembly of large structures in space: a technology review

Mathieu Rognant, Christelle Cumer, Jean-Marc Biannic, Maximo A. Roa, Antoine Verhaeghe, Vincent Bissonnette

► **To cite this version:**

Mathieu Rognant, Christelle Cumer, Jean-Marc Biannic, Maximo A. Roa, Antoine Verhaeghe, et al.. Autonomous assembly of large structures in space: a technology review. EUCASS 2019, Jul 2019, Madrid, Spain. hal-03316188

HAL Id: hal-03316188

<https://hal.science/hal-03316188v1>

Submitted on 6 Aug 2021

HAL is a multi-disciplinary open access archive for the deposit and dissemination of scientific research documents, whether they are published or not. The documents may come from teaching and research institutions in France or abroad, or from public or private research centers.

L'archive ouverte pluridisciplinaire **HAL**, est destinée au dépôt et à la diffusion de documents scientifiques de niveau recherche, publiés ou non, émanant des établissements d'enseignement et de recherche français ou étrangers, des laboratoires publics ou privés.

Autonomous assembly of large structures in space: a technology review

Mathieu Rognant^{*†} *Christelle Cumer*^{*} *Jean-Marc Biannic*^{*}
Maximo A. Roa[•] *Antoine Verhaeghe*⁺ *Vincent Bissonnette*[◊]
^{*}*ONERA - The French Aerospace Lab, 31055 Toulouse, France*
[•]*German Aerospace Center (DLR), 82234 Wessling, Germany*
⁺*CSEM, 2002 Neuchatel, Switzerland*
[◊]*Magellium, 31520 Ramonville Saint-Agne, France*
[†]*mathieu.rognant@onera.fr · *christelle.cumer@onera.fr*

Abstract

Autonomous assembly of large structures in space is a key challenge to implement future missions that will necessitate structures to be self-deployed as a single piece. This paper presents a mission analysis of existing concepts for in-space assembly of telescopes, provides a survey of relevant robotics technologies and introduces the expected contribution of the PULSAR (Prototype of an Ultra Large Structure Assembly Robot) project to this challenge.

1. Introduction

The European Commission has set up the Space Robotics Technologies Strategic Research Cluster (SRC) in Horizon 2020, with the goal of enabling major advances in strategic key-points of this domain. To fulfill this objective an European roadmap composed of three successive calls (2016, 2018 and 2020) have been defined by the PERASPERA consortium which is composed of the main European space agencies. The first activities in the 2016 call have addressed the designing, manufacturing and testing of reliable and high performance common robotic building blocks for operation in space environments (orbital and/or planetary). The specific objective of the 2018 call is to integrate the previously prepared common building blocks into demonstrators, on ground, towards applications of space robotics in the field of orbital and planetary use.

The robotized assembly of large modular orbital structures (i.e. Operational Grant 8, OG8 of this call) has been identified as one of the key challenge of the orbital use which should be addressed. Future missions implementation will necessitate structures too large to be self-deployed as a single piece. The James Webb Space Telescope⁹ has reached this limit and the next generation telescope expected by astronomers, like the LUVOIR,⁵ will therefore require new assembly technologies, in particular autonomous robots. The need for large structures in space goes beyond telescopes and concerns also solar arrays for power plants, light sails to reach outermost regions of the solar system or heat shields to land on Mars.

The PULSAR (Prototype of an Ultra Large Structure Assembly Robot) project is related to OG8. It aims at developing and demonstrating the technology that will allow the on-orbit precise assembly of a very large primary mirror by an autonomous robotic system.

A segmented space telescope needs multiple mirror tiles and multiple interfaces and therefore a precise way to assemble them. This is fulfilled by perception and planning algorithms that make use of extended mobility for very large structures, which requires a controlled, stable spacecraft during operations and a spacecraft structure that provides attachment and housing for arm and tiles.

This paper reviews the state of the art on technologies relevant to the achievement of the PULSAR objectives. In a first section a mission analysis, investigating previous and near-future similar missions, is achieved to derive high level recommendation for PULSAR-like missions and propose a system architecture. In a second section a technology review, analysing in-depth the different building blocks foreseen for PULSAR through a review of state-of-the-art technologies and near-future developments, is provided. Finally, the project PULSAR (Prototype of an Ultra Large Structure Assembly Robot) is introduced as the latest European effort to develop and demonstrate the technology that will allow the on-orbit precise assembly of a very large primary mirror by an autonomous robotic system.

2. Mission Analysis

Different approaches have been proposed to achieve in-space assembly of telescopes. In general, the concepts include a modular deployable structure, satellites flying in a coordinated fashion, or a mission including a general purpose robot with advanced autonomous assembly capabilities. An overview is provided by M.Roa and al in.²¹ This section presents the process followed in the context of the PULSAR project to define a system architecture.

2.1 High level Science needs and context

Science observation from ground is limited by a significant part of the electromagnetic spectrum being absorbed by the atmosphere. Concretely, Earth's atmosphere is nearly opaque, enabling visibility only within two very specific ranges of wavelength: first, visible spectrum (1 μm wavelength); and a second interval from microwaves (1 cm wavelength) to radio and TV (10 m). Outside of these intervals, almost nothing could be observed from ground.

Space telescopes however offer improved capabilities. Being able to observe the whole electromagnetic spectrum without the atmosphere limitation, the information that can be collected is much more varied. To this purpose different instruments have been developed, enabling observation from ultraviolet to infrared, thus multiplying the possibilities for the scientific and astronomical communities. With the information collected from different spectral bands, scientists are able to determine the composition of distant bodies, the distance to the object and even the date when the celestial body was created. These features are not possible with the capabilities of ground telescopes, even if the latter can benefit from bigger collecting surfaces, more complex equipment, and in general any other advantage derived from its implementation on ground. The future of astronomy and science of the universe needs necessarily space telescopes, and such telescope needs to be more and more performing in order to satisfy the increasing needs of this community. At the same time, some technological barriers that were limiting factors some years ago tend to disappear or decrease their influence, enabling significant improvements of the observation capabilities.

The scientific roadmap can be summarized highlighting the following goals:

- Understanding the universe life which needs versatile space observatory in ultraviolet wavelength with factor 50-100 greater than existing facilities (Hubble Space Telescope).
- Planet formation and emergence of life (exoplanets) which require UV field within 50-100 times higher sensitivity for observation of key atmospheric ingredients of Earth-like exoplanets
- Study of the solar system.



Figure 1: Deployment of the James Webb Telescope (launch planned for 2021) (Courtesy of NASA).

Based on this roadmap two missions are already scheduled:

- The James Webb Space Telescope (JWST)⁹ will feature a deployable 6.5 m diameter primary mirror and is planned to be launched in March 2021. The telescope has a nominal life-time duration of 5.5 years, and a best estimate of 10 years. It could thus be considered that the needs of the scientific community in terms of space observation would be covered up to 2030 in the best case.
- The USA are already anticipating the next generation space telescope after JWST with the Large UV Optical Infrared Surveyor (LUVUOIR)⁵ proposed to be launched in 2039. LUVUOIR-A will feature a 15 m deployable primary mirror.

In the meanwhile there is an opportunity for an European mission if this mission arrives not later than 2035. PULSAR has to target this timeframe in order to cope with basic profit objectives. In addition this context allows us to define the primary mirror size which should be deployed. The targeted value is a diameter of 10 m (75 m²). At least a diameter of 8 m (50 m²) is mandatory to outperform JWST (20 m²).

2.2 Orbit and Launcher Constraint

The target orbit and launcher capacity are key sizing parameters of such on-orbit assembly missions:

Orbit selection Three possibilities -a LEO orbit, a geostationary orbit and the L2 Lagrange Sun-Earth point- were analyzed and compared according to three main indicators: the mission feasibility/performance, the mission availability and the lifetime.

Space telescopes impose stringent constraints on pointing accuracy and stability to ensure that collected images are usable. The first indicator therefore focuses on the selection of an orbital environment allowing the required level of precision. Disturbances in terms of torques and forces acting on the platform could penalize the interest of the mission or require a more complex design of the platform and actuators. For this first criterion, the low Earth orbit environment has high gravitational forces, while the L2 point has the advantage of lower forces and lower disturbance torques.

The second indicator focuses on the impact of orbit selection on the spacecraft's ability to collect data. In other words, it is necessary to quantify the number of mission hours without interruption or the ratio between data collection intervals over the total duration of the mission. Maximizing availability is an essential aspect of space missions, where lack of availability can lead to a loss of opportunities to observe rare or sporadic phenomena. This criterion penalizes a telescope in LEO which, for an orbital period of about 100 minutes, has a duration of observation limited to about ten minutes. In GEO, the observation possibilities last longer, but the Sun or the Earth ends up obscuring the observation target. The main advantage of GEO is the continuous visibility of a ground station at the same longitude as the telescope. This is an important parameter for sizing data collection capabilities, with the possibility of a permanent data link between ground and spacecraft. L2 missions allow the long-term observation of targets without interference from the Sun or the Earth in a large cone opposite to the Sun-Earth-Spacecraft direction. The availability of the mission is no more limited from the point of view of space dynamics, but from the ability to transmit the collected data.

The third indicator is the optimization of the life time of the spacecraft. This last criterion favors LEO missions because they have the advantages of a short transfer from launch to operation and a less demanding environment in terms of radiation, which can affect critical electronic equipment. L2 orbits are clearly the least interesting as state-of-the-art missions in L2 present only 5 to maximum 10 years life-time duration.

As the most important objective is feasibility and performance of the mission, L2 is the most suitable choice. Moreover the choice of L2 is supported by current and future similar missions with comparable objectives (e.g. scientific missions for the study of universe).

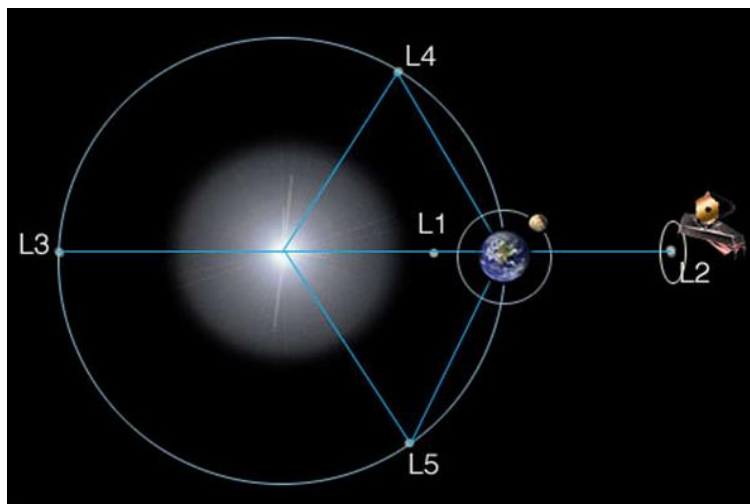

Figure 2: Sun-Earth Lagrangian points (Courtesy of NASA)

Launcher selection The USA can envision missions with large deployable telescopes like LUVOIR because they are counting on future powerful and big launchers, such as SLS,⁷ that Europe does not have. In order for PULSAR to compete (in terms of performances and also economically) with American telescopes the use of a consolidated launcher over one under development is a key feature. In this context, development of Ariane 6 is in advance compared to SLS and will be fully operational in the time scope of PULSAR launch.

To improve the size capabilities of the primary mirror, a double launch scenario (considering a master vehicle holding the instruments and the platform functions and a cargo vehicle launching full of mirror tiles) may be considered. This option presents two main difficulties. First, the rendez-vous operation between master and cargo vehicles which have to meet in space. The second difficulty concerns the assembly of the mirror itself, which would need a long robotic arm. Tiles would have to be taken from the container and assembled into the primary mirror without counting on additional support other than the spacecraft structure.

Mass limitations To evaluate the faisability of a single launch scenario with the Ariane 6, a preliminary mass budget is established by using JWST as reference and identifies the additional items present in PULSAR spacecraft. JWST is a good reference as it already implements most of the features that PULSAR needs. So, to proceed this sensitivity analysis, the mass increase implied by the addition of the robotic arm and the larger primary mirror is evaluated. Based on state-of-the-art of mirror structure and tiles interfaces, the evaluated primary mirror density range are set between 20 kgm² and 40 kgm². In similar way the RAS mass range is set between 0.5 Tn and 1.5 Tn.

Attending to launched mass, PULSAR design target must not exceed 8.4 Tn in order to guarantee compatibility

	50m ² primary mirror (φ8m)		75m ² primary mirror (φ10m)			
James Webb (platform & payload with 25m ² mirror)	6,4 Tn	6,4 Tn	6,4 Tn	6,4 Tn	6,4 Tn	6,4 Tn
Delta primary mirror (reference is JWST, 25m ² mirror)	+0,5 Tn , (20kg/m ²)	+1 Tn , (40kg/m ²)	+1 Tn , (20kg/m ²)	+1 Tn (20kg/m ²)	+1,5 Tn (30kg/m ²)	+1,5 Tn (30kg/m ²)
Robotic arm + interfaces	+0,5 Tn	+0,5 Tn	+0,5 Tn	+1 Tn	+0,5 Tn	+1 Tn
Total Mass	7,4 Tn	7,9 Tn	7,9 Tn	8,4 Tn	8,4 Tn	8,9 Tn

Table 1: Mass budget sensitivity analysis

with Ariane 6 (by using A64 version with four boosters) for the kind of orbit that is considered (Sun-Earth Lagrange L2 point). A first mass budget sensitivity analysis summarized on Table 1 shows that the 8 m diameter mirror is an achievable goal and the 10 m diameter mirror would require specific mass optimization.

Size limitations Figure 3 presents the concept for primary mirror assembly using independent hexagonal tiles. These tiles are taken from a container or dispenser and are manipulated by the robotic arm during assembly operations. In order to check if the number of tiles needed to form the primary mirror can effectively fit within the launcher capacity, a preliminary sizing has been done supposing a very basic shape of the space vehicle. This design considers a cylindrical shape vehicle, optimized to best fit launcher’s internal fairing. Attending to this, the maximum diameter of the cylinder is not to exceed 4.5m and the main modules forming the spacecraft are stacked vertically (figure 4). It is composed of a service module, including all basic functionalities (power supply, on-board computer), a payload module, with all the electronics and data handling needed to support the instruments, a tiles container and a support for the secondary mirror.

To maximize filling of the container, two specific tiles disposition have been evaluated: 6 tiles of 1.5 m diameter per floor and 3 tiles of 2 m per floor. The both configuration would fit within the dedicated volume of 6 m height assuming that the vertical dimension of the tiles is lower than 50 cm. However a trade-off should be found concerning the tile size. Bigger tiles would reduce their number, reduce assembly operations and the mass needed in structure and interfaces. On the other hand, smaller tiles offer better performances once assembled thanks to a finer resolution.

2.3 System architecture and requirements

The previous analysis demonstrates that a single launch scenario is an achievable goal for deploying an orbital telescope which complies the science needs. However this solution involves strict requirements on the Robotic Arm System (RAS), the Segmented Mirror Tiles (SMT) and the spacecraft stability. To fulfill this requirement, the PULSAR

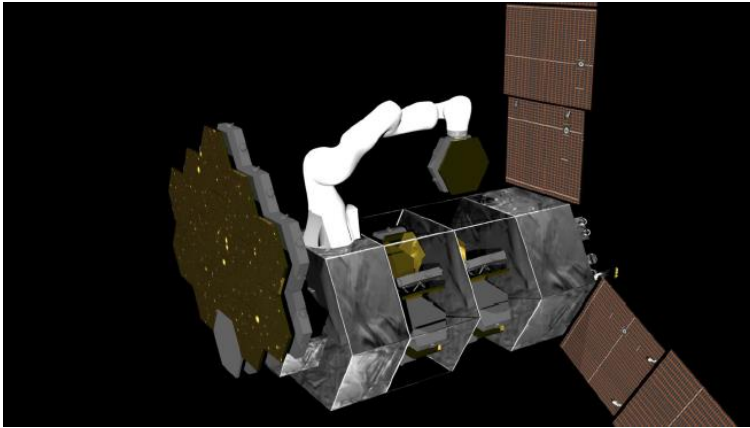

Figure 3: PULSAR Primary mirror concept

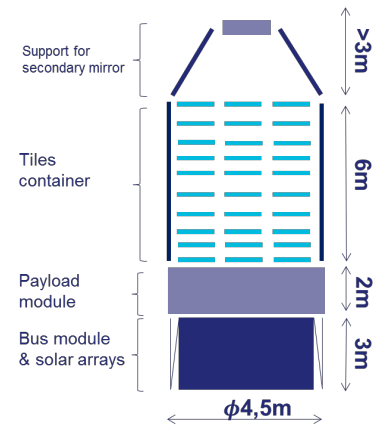

Figure 4: Sizing configuration

project proposes to integrate and improve the common building block developed in the PERASPERA context. The proposed architecture using these components is presented on figure 5 and is composed of the following three high-level elements:

- A functional assembled mirror with independently adjustable tiles:
Scientific and operational requirements dictate that the primary mirror must be composed of a large number of segmented tiles, autonomously assembled one by one, with high precision, in orbit. The individual mirror tiles must thus interface to form a parabolic section. Additionally, such a large segmented telescope needs to have an active and precise correction of the position of each mirror surface.
The large number of segmented mirror tiles further drives the need for a standard interface to join them, manipulate them, and ensure their final functionality (provide power, data and thermal networks).
- A Robotic Arm System (RAS):
This RAS should be able to manipulate SMT in a large work-space and realize also precision assembly. These two opposite goals require extended mobility functionality (walking robot or translation rail).
On the software side, specific low-level arm control functions is required to perform a rendezvous between interfaces and ensure a final positioning within tolerances. High-level planning functions is also needed to safely execute the arm movements. Moreover, to further increase the robustness of this precision assembly, the RAS should include vision and LiDAR-based localization functions.
- A stable spacecraft:
The critical aspects of the spacecraft stabilization are to simultaneously manage the dynamically changing inertia of the system induced by the tiles deployment and the disturbance torques induced by the robotic arm movements. An additional challenge will be to ensure that the real-time implementation of designed Attitude and Orbit Control System (AOCS) satisfies the mission requirements and the stringent on-board computational constraints. Delays and limited sensors bandwidth, as well as sampling times strongly affect the AOCS performance.

In the following section, a review of the relevant technology are presented.

3. Technology review

3.1 Segmented Mirror Tiles

On ground, many big telescopes have a segmented primary mirror. The biggest monolithic primary mirrors are 8.4m wide and equip the Large Binocular Telescope (LBT in Arizona USA). Such monolithic mirrors are as large as the current technology permits. Segmented primary mirrors technology allows the construction of wider mirrors and also provides significant advantages: Segments are easier to manufacture, transport, handle, install and maintain than a monolithic mirror; Segmented mirrors can be made thinner and thus lighter; Mechanism behind segmented and monolithic mirrors are used to correct the mirror shape under changing gravity orientation. Such mechanism are simplified and lighter behind a segmented construction.

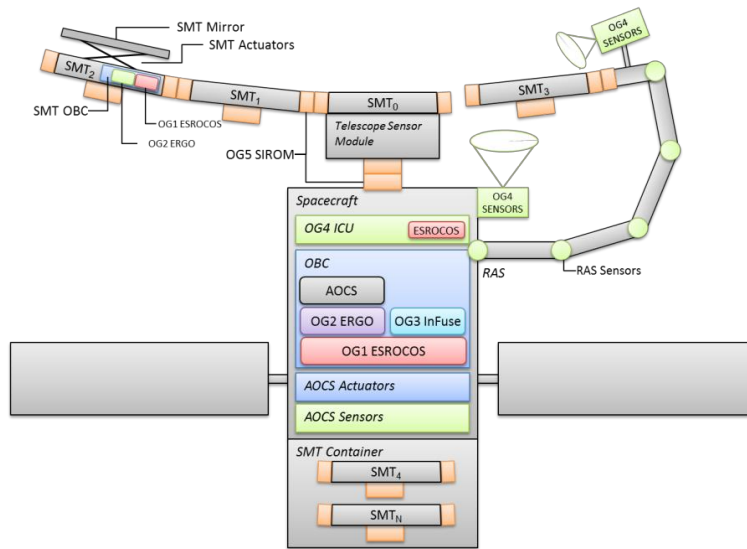

Figure 5: PULSAR architecture, based on previous components

In the context of PULSAR, each SMT is independent and integrates three sub-components enabling its assembly and precise adjustment: a base structure, a mirror and between them a positioning system. The base structure carries several standard interfaces to allow the manipulation and the connection with the other tiles.

The first function of the SMT positioning system is to compensate the residual positioning error after the assembly task to obtain the required primary mirror shape. The second function is to realize wavefront corrections by adapting the mirrors shape and position. Even if space telescope will suffer from no atmospheric perturbation, some wavefront correction system is still needed to compensate thermal effect, as well as the gravity variation between earth-mounting conditions and on orbit mission.

The second function is the most restrictive. To respect the primary mirror maximal acceptable wavefront error, which is part of the overall telescope wavefront error budget, the SMT positioning systems shall have nano-metric positioning capabilities.²⁴ For this purpose, hexapod manipulators are more suitable as illustrated on figure which present the JWST tile positioning system.

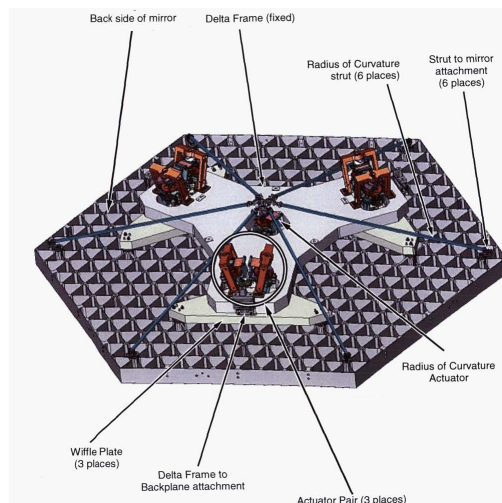

Figure 6: JWST tile positioning system²⁴

3.2 Standard Interface

The standard interface is a robotic device providing mechanical, data and power transfer between different components of the system. During assembly of the telescope, they are used as end-effector of the robotic arm to manipulate the

individual segmented tiles. Once assembled, during operation, through the mechanical connection, they provide the mechanical integrity of the segmented telescope. At the same time, the integrated connectors enable data and power transmission between the different tiles and with the OBC.

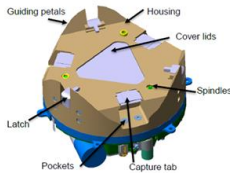

Figure 7: SIROM interface design and components

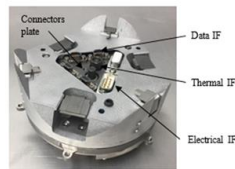

Figure 8: HOTDOCK interface concept before and after coupling

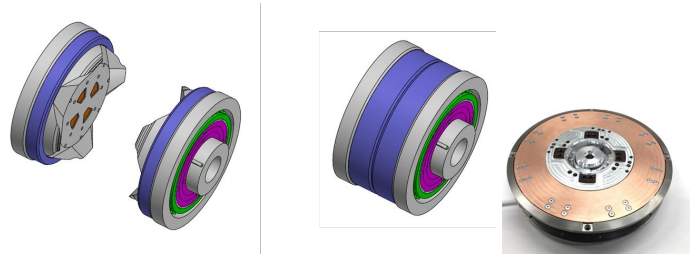

Figure 9: iBOSS iSSI Interface

In the context of PULSAR three interfaces have been considered:

- The SIROM interface is the product of the OG5 activity,¹⁰ one of the building block of the first SRC call. The SIROM interface is a standardized robotic interface consisting of mechanical, electrical data, thermal and control interfaces. It aims at connecting payloads to payloads or payloads to structures, with the capability to transfer mechanical loads, data power and heat. With an androgynous design, it can match and couple another SIROM interface on one side. On the other side, it can be connected to an Active Payload Module (APM) or to the end-effector of a robotic manipulator.
- HOTDOCK is a standard robotic interface supporting mechanical, data, power and thermal transfer. Under development by Space Applications Services, its design has been initiated to provide an answer to the highlighted weaknesses of SIROM design in the context of the second call of PERASPERA roadmap, while keeping the same targeted applications.
- The iSSI interface¹² has been designed by the iBOSS consortium and is commercially available from iBOSS GmbH for Laboratory version. The multifunctional interface iSSI combines the four subassemblies for power, data, heat and mechanical load transfer. The main parts of the mechanical interface include the coupling and guiding elements as well as the positioning pins that are arranged around the data interface. Around the mechanism, the thermal interface consists of a carbon-nanotube copper-alloy composite material (the mechanical interface can be implemented without the thermal).

The table 2 provides high level feature comparison between the different envisaged interfaces.

3.3 Robotic Arm System

Autonomy requirements Assembling a large space structure implies putting together modular components in an ordered fashion, dictated by a high level master plan that indicates the relative positioning of each part. Common robotic systems in space applications have a small degree of autonomy. The execution of tasks usually relies on remote operations, which require an appropriate feedback channel for the operator, typically affected by substantial time delays. The concept of shared autonomy increases the dexterity of such systems and reduces the effort for the operators in difficult tasks. Nevertheless, remote operation approaches are not suitable for assembling a complex structures. Because of the fine granularity of assembly tasks, classical remote operation becomes unfeasible as it consumes substantial amounts of time for the synchronization of operator commands and manipulator actions. Therefore, a robotic assembly system should be capable of performing a sequence of operations or even the complete assembly task autonomously.

Current technology Autonomous operations in space are still very challenging and there have been a limited number of demonstrations on-orbit. The first successful demonstration of an unmanned spacecraft to conduct autonomous rendezvous and docking operations was done by NASDA in 1999 on ETS-VII. It was the first satellite equipped with a robotic arm that allowed ESA to conduct the VIABLE experiment demonstrating computer vision support for autonomous robot control. Several robotic arms are now present on board the ISS, including Canadarm, Dextre and Kibo, but for now they are all teleoperated. Autonomous robotic assembly of space systems has been demonstrated on ground for planar truss and beam structures, but their test in orbit and with more complex structures still remains a challenge. Among the missions under development, NASA's Restore-L and DARPA's RSGS are expected to demonstrate

Characteristic	HOTDOCK	SIROM	IBOSS
Envelope Dimension (not including electronics)	156mm / 130mm \varnothing 65mm height	120mm \varnothing 75mm	120mm (220mm with thermal) \varnothing 50mm
Mass	1.2kg	1 kg (without electronic)	0.8kg (2.5kg with thermal)
Androgynous Design	X	X	X
90deg Symmetry	X		X
Allowing Diagonal Engagement	X		X
Position Finding by Form-Fit	X		
Locking Support by Form-Fit	X	X	
Sealing	X		
Can force passive side to dock/undock	X (Full)	X (elec)	X (mech)
Docking sequence duration	< 30 sec	[8 min, 2.6 min] c.f. motor control	< 30 sec
Load Transfer Axial (no SM)	20.000N (Theoretical)	1600 N (simulation)	6.000N
Load Transfer Radial (no SM)	TBC	TBC	[90-300]N
Load Transfer Moment (no SM)	1.500Nm (Theoretical)	50Nm (simulation)	360Nm
Power Transfer	[1kW] @ 100V	120W @ 100V	2.5kW
Data Transfer	Ethernet/TTE/SpaceWire, CAN	SpW/CAN	Ethernet/CAN
Thermal Transfer	Thermal tube (design)	Thermal tube	Thermal plate

Table 2: Standard Interfaces Specifications Comparisons

in the near future the autonomy and dexterity required for on-orbit assembly. An overview of current technologies for in-space assembly is provided in.²⁰



Figure 10: Canadarm2

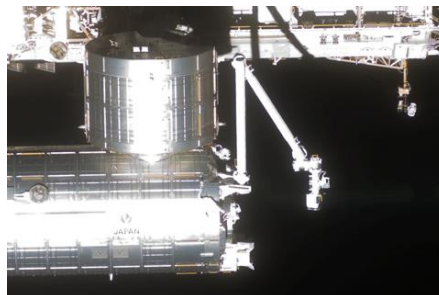

Figure 11: JEM-RMS

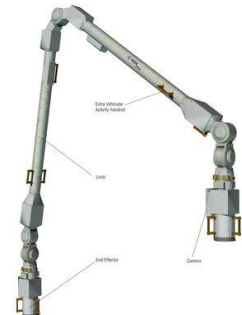

Figure 12: ERA

Extended mobility Given the size of the mirror envisaged for a space-based telescope, the robotic arm would need some kind of mobility in order to reduce its required length. A very long robotic manipulator would make very difficult to meet the accurate position and orientation requirements needed for assembly; a preferred solution is using a smaller robotic manipulator (typically 1 to 2 m length) but with the ability to move within the structure. Two main alternatives have been analyzed for providing the required mobility: a walking manipulator, and mobility within a rail. The lower complexity of the second option makes it preferable at this stage of the study. Although no space applications are known so far implementing this kind of technology, it is common on ground applications. On the other hand, different walking manipulators have been implemented for space applications, including ERA and SSRMS.⁸ A proof of concept of a walking manipulator for a space-based assembly application is currently under development in OG9-MOSAR.¹³

PERASPERA building blocks The autonomy requirements could be addressed by using the OG1 (ESROCOS) and OG2 (ERGO) building blocks

- ESROCOS is a framework for developing robot control software applications. It includes a set of tools that support different aspects of the development process, from architectural design to deployment and validation. In addition, it provides a set of core functions that are often used in robotics or space applications.²
- ERGO is a framework for on-board autonomy systems¹⁷ based on two main components:

- A functional layer which performs the requested actions by the executive layer. The functional layer will use the ESROCOS framework to provide the interface with the hardware.
- An ERGO agent which controls the execution of the functional layer. This agent will enclose a set of control, which can implement deliberative or reactive behaviours, and a central agent which ensures the correct interaction among the different control loops.
The interface among different components of the ERGO agent will be based on goals (action or state desired to be achieved) and observations (sensors data, or internal state deduced from the functional layers information).

Adaptable perception, localization and mapping techniques are also required to guide the assembly process. After the telescope is assembled, a metrology system needs to be employed for verifying the location and orientation of each mirror tile, so that adjustments can be made to achieve the required accuracy and precision.

The OG3 (INFUSE) provides an open-source Common Data Fusion Framework (CDFF) by which data may be fused in a modular fashion from multiple sensors.¹⁹

The OG4 (I3DS) relevant components for the PULSAR used-case are:

- The Instrument Control Unit (ICU) which provide "data concentrator" function. It is used as the central point through which all of the OG4 Sensor Suite are connected. This allowed a single and standard interface between the OBC and all sensors.
- The High Resolution (HR) camera is foreseen to perform visual servoing at short range.
- The pattern projector is also foreseen and will serve two purposes: first as an illumination device for the scene and second coupled with the HR camera, it can provide 3D measurements.
- The stereo camera is proposed as a back-up: this can be used on the platform side to monitor the assembled mirror.

3.4 AOCS Controller

The AOCS must be designed to support all mission's needs from launch and early orbit phase (LEOP) to satellite disposal. The satellite must implement at least the following operational phases: launch phase, transfer phase, deployment phase, mission phase, deorbit phase. Each phase is supported by one or more AOCS modes.¹⁴ In the context of PULSAR, our main concern will be to design efficient controllers for the deployment phase and mission phases. The deployment phase is normally entered when the satellite has finally reached the target orbit and all the satellite's appendages (i.e. solar arrays, antennas, instruments) are deployed. The mission phase begins after the deployment and it is maintained up to the end of mission before satellite disposal.

The deployment phase is certainly the most challenging as far as the control design problem is concerned. During this time period indeed, as already observed in the early work with ETS-VII,¹⁸ it is important to stabilize the attitude with a reasonable accuracy to keep communication link despite the torque perturbations that are generated by the robotic arm. Moreover, the robotic arm is used to build the primary mirror from tiles that are progressively deployed from the main body. As a result, the inertia of the total satellite varies rather slowly but significantly during this deployment phase. Many different strategies have been developed in the literature over the past thirty years to handle attitude control problems in the presence of time varying inertia, for instance Adaptive Control Techniques for Linear Time Varying systems,^{6,15} linear parameter varying models,¹¹ or robust control techniques that consider the variations in the inertia matrix as time-varying uncertainties.²²

Among possible approaches, one can mention Adaptive Control Techniques for Linear Time Varying systems initially developed in¹⁵ and recently revisited in²³ and.⁶ The central difficulty with adaptive control techniques is to obtain a guaranteed performance level. This is why alternative LPV-based methods are often preferred.¹¹ Moreover, when the variations in the inertia matrix remains sufficiently small, the latter can be viewed as time-varying uncertainties and robust control techniques become applicable.

In²² for example such a method, based on a smoothed sliding mode control strategy is applied to provide a robust attitude controller using reaction wheels. Sliding mode control techniques are indeed very interesting since they exhibit high robustness properties and well suited to nonlinear systems. However, they tend to generate aggressive control inputs which often cannot be realized by limited reaction wheel systems. In this respect, a better compromise is generally reached by robust control techniques mixing the LPV concept and the Hinfinitiy design framework.¹⁶

Based on results presented in,³ our approach to solve the problem will be based on a multi-model Hinfinitiy design framework from which a robust and possibly parameter-varying attitude controller will be obtained. The perturbations (typically those generated by the onboard manipulator) that cannot be rejected without a significant performance loss,

will be online estimated by a torque observer as shown in Figure 13. The latter can be designed either using the Hinfinity or the LPV framework.

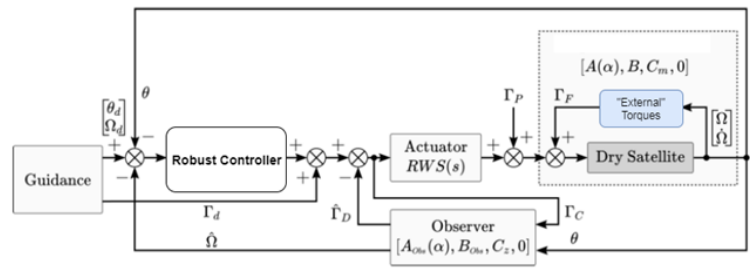

Figure 13: AOCs control structure

During the observation phase, the inertia matrix does not change significantly. However, pointing stability is the driving requirement for high-quality imaging in a space telescope.⁴ The full primary mirror tends to generate badly damped and rather low frequency torque perturbations. The main control design issue will then consist of enhanced weighting functions tuning to optimize the compromise between a reasonable pointing accuracy and disturbance rejection. The general structure of the AOCs during deployment will be kept in order to facilitate control switching from the deployment phase to the observation phase.

3.5 Modelling tools

Such control techniques need models highlighting physical parameters and the different dynamic couplings due to torques induced by the robotic arm motions and different kinds of appendages such as flexible solar arrays, thermal shield and the primary mirror of the telescope. These constraints lead to choose and couple two modelling tools :

- the first one is the Satellite Dynamics Toolbox (SDT - see <https://personnel.isae-supaero.fr/daniel-alazard/matlab-packages/satellite-dynamics-toolbox.html>), based on a multi-body modelling approach. This toolbox allows to build generically a parametric linear model of a satellite composed of a rigid hub, rigid appendages and/or flexible appendages. The key idea, detailed in,¹ is to compute, for each substructure, its inverse dynamic model: this transfer matrix has
 - a input vector, composed of external forces and torques (wrench torque) applied on this substructure
 - and a output vector, composed of the linear and angular accelerations (derivative of the twist vector) at a point of the substructure.

A cantilevered connection of a -flexible or not- appendage on a satellite hub results in a simple feedback, since the appendage is subjected to a force opposite to that which the hub undergoes. It is also at this connection, that reference points and reference frame can be changed or that different kinds of connection (pivot,...) can be considered. All couplings are then taken into account. Such an approach allows one to split the geometric and dynamic parameters of each substructure and each link into specific blocks. Moreover, as each substructure is separately modelled, the physical parameters are repeated minimally: it is also one of the advantages of the approach.

- the second one is the open-source NPS-SRL/SPART (see <https://spart.readthedocs.io/en/latest/>), which can derive easily the dynamics of the robotic manipulator. It is explicitly dedicated to kinematic trees composed of rigid links and joints.

4. PULSAR: Prototype of an Ultra Large Structure Assembly

The PULSAR project aims at developing key technology listed in the previous technology review.

The retained method by PULSAR will involve two physical demonstrators (one focused on the assemble of a fully functional section of a telescope mirror on earth conditions and the other on the assemble a very large structure in low gravity - underwater - conditions) and one simulator (evaluation of the PULSAR technology in space conditions).

4.1 Demonstrator of precise assembly of mirror tiles (dPAMT)

The demonstrator for precision assembly of mirror tiles will show the capabilities to autonomously assemble several mirror tiles following specifications from a Master plan. This demonstrator will be implemented with a combination of adaptable perception, integrated assembly and grasp planning, and compliant control of the manipulators. The assembly demonstrator will rely on an assembly planner, which integrates a grasp planner and a motion planner, for autonomously creating a master plan for the overall process starting with the specification of the desired assembly. The system automatically decomposes a given assembly into a task sequence, which is then mapped to a sequence of appropriate robotic skills. The skills exploit the capabilities of a lightweight and highly sensitive robotic manipulator, the KUKA iiwa, for achieving compliant operations that guarantee successful execution of the robotic skills even in the case of positional or sensorial uncertainties. Standard interfaces will be used both at the end point of the robotic arm and at the mirror tiles, to facilitate the retrieval and repositioning of the SMTs. The main limitations of the demonstrator will be gravity and the robotic arm's payload limit, which restricts the achievable size of the assembled structure.

Visual servoing will be an important component for verifying the execution according to the nominal plan. Additional external sensors are required to provide a ground truth measurement for robot positioning and motion, and for measuring the success of the assembly process for the space telescope. An external measuring device will be used to verify the pose of each individual mirror tile in order to validate the geometry and configuration of the primary mirror, and to define the adjustments required to perform an optical alignment to a given focal point.

4.2 Demonstrator of large structure assembly in free floating environment (dLSAFFE)

To simulate on-orbit conditions, in particular the effects of micro-gravity, the autonomous assembly of a large segmented mirror in underwater conditions will be demonstrated. This needs advanced mobility to overcome the limits of robotic arm adaptability to the accumulated assembly errors, and an optimal Attitude and Orbit Control System (AOCS) to stay in the required pose. An underwater platform endowed with a robotic manipulator will be used, and thrusts in the platform will help to control the effects of impulsive forces created during the assembly operation. The extended mobility of the arm will show the feasibility of assembly operations of a large structure. For this demonstrator, all the technical sub-systems have to be adapted for underwater operation, including the connectors and the mirror tiles.

4.3 Demonstrator of In-Space Assembly in Simulation (dISAS)

This last demonstrator will address the challenge of autonomously deploying a large structure in space while ensuring the stability and safety of the spacecraft. To compensate the limitations of the fidelity of low-gravity facilities (such as time-delay for the robotic platform and water-drag instead of neutral buoyancy), simulation means are retained as the third demonstrator. This includes accurate physical models of spacecraft, robotic assembly system, and segmented mirror tiles, to estimate torque disturbances involved in the deployment as well as robust controllers to manage them. Software coming from the previous OGs will be embedded. The objective is to demonstrate that the deployment of large structures and active tessellated mirror control can be carried out on-board a spacecraft respecting the AOCS requirements.

5. Conclusion

This paper provided an overview of different technologies proposed for the assembly of a large structures in space. The paper primarily focused on the mission analysis of telescope assembly in space and the maturity assessment of the technology required. It was demonstrated that the complete assembly process requires, in particular, robotic arm systems with advanced autonomous systems as well as stable control of the spacecraft.

The European project PULSAR was finally introduced, which aims to provide a first experimental verification for low-level technologies that need to be further developed for in-space autonomous assembly of complex structures such as telescopes. This goal will be achieved through three different demonstrators, based on a mobile robotic manipulator (for testing autonomous assembly and optical verification of the telescope), an underwater platform (for testing assembly in a low gravity environment), and a simulation-based approach for testing a full mission. The final demonstrations will be performed in 2021.

6. Acknowledgments

We thank Aurelien Cuffolo, Sabrina Andiappane and Pablo Negro Lopez from Thales Alenia Space France for providing informations for the mission analysis.

The PULSAR project is funded under the European Commission’s Horizon 2020 Space Strategic Research Cluster Operational Grants, grant number 821858

References

- [1] Alazard Alazard, Christelle Cumer, and Khalid Tantawi. Linear dynamic modeling of spacecraft with various flexible appendages and on-board angular momentums. In *7th International ESA Conference on Guidance, Navigation Control Systems*, 2008.
- [2] M Muñoz Arancón, G Montano, M Wirkus, K Hoeflinger, D Silveira, N Tsiogkas, Jérôme Hugues, H Bruyninckx, I Dragomir, and A Muhammad. Esrococ: a robotic operating system for space and terrestrial applications. In *14th Symposium on Advanced Space Technologies in Robotics and Automation (ASTRA 2017)*, pages pp–1, 2017.
- [3] J.M. Biannic, C. Roos, and J. Lesprier. Nonlinear Structured H_∞ Controllers for Parameter-Dependent Uncertain Systems with Application to Aircraft Landing. *AerospaceLab Journal*, (13):pages 1–15, November 2017.
- [4] Lars Blackmore, Emmanuell Murray, Daniel P Scharf, Mimi Aung, David Bayard, Paul Brugarolas, Fred Hadaegh, Allan Lee, Mark Milman, Sam Sirlin, et al. Instrument pointing capabilities: past, present, and future. 2011.
- [5] Matthew R Bolcar, Steve Aloeos, Vincent T Bly, Christine Collins, Julie Croke, Courtney D Dressing, Lou Fantano, Lee D Feinberg, Kevin France, Gene Gochar, et al. The large uv/optical/infrared surveyor (luvoir): Decadal mission concept design update. In *UV/Optical/IR Space Telescopes and Instruments: Innovative Technologies and Concepts VIII*, volume 10398, page 1039809. International Society for Optics and Photonics, 2017.
- [6] Kaiwen Chen and Alessandro Astolfi. Adaptive control of linear systems with time-varying parameters. In *2018 Annual American Control Conference (ACC)*, pages 80–85. IEEE, 2018.
- [7] Renee Cox, Steven D Creech, and David Hitt. Nasa’s space launch system: Unprecedented payload capabilities. 2018.
- [8] V. Dubanchet. Modeling and control of a flexible space robot to capture a tumbling debris. In *Doctoral dissertation, École Polytechnique de Montréal*, 2016.
- [9] Jonathan P Gardner, John C Mather, Mark Clampin, Rene Doyon, Matthew A Greenhouse, Heidi B Hammel, John B Hutchings, Peter Jakobsen, Simon J Lilly, Knox S Long, et al. The james webb space telescope. *Space Science Reviews*, 123(4):485–606, 2006.
- [10] Marko Jankovic, Wiebke Brinkmann, Sebastian Bartsch, Roberto Palazzetti, and Xiu Yan. Concepts of active payload modules and end-effectors suitable for standard interface for robotic manipulation of payloads in future space missions (sirom) interface. In *2018 IEEE Aerospace Conference*, pages 1–15. IEEE, 2018.
- [11] Rongyu Jin, Xueqin Chen, Yunhai Geng, and Zhili Hou. Lpv gain-scheduled attitude control for satellite with time-varying inertia. *Aerospace Science and Technology*, 80:424–432, 2018.
- [12] M Kortman, S Ruhl, Jana Weise, Joerg Kreisel, T Schervan, Hauke Schmidt, and Athanasios Dafnis. Building block based iboss approach: fully modular systems with standard interface to enhance future satellites. In *66th International Astronautical Congress. Israel, Jerusalem*, pages 1–11, 2015.
- [13] P. Letier, X. Yan, M. Deremetz, A. Bianco, G. Grunwald, M. Roa, R. Krenn, M. Munoz, P. Dissaux, J. Sanchez, R. Ruiz, L. De Filippis, G. Porcelluzzi, M. Post, M. Walshe, and P. Perryman. MOSAR: Modular spacecraft assembly and reconfiguration. In *Symposium on Advanced Space Technologies in Robotics and Automation - ASTRA*, 2019.
- [14] Leonardo Mazzini. *Flexible Spacecraft Dynamics, Control and Guidance*. Springer, 2015.
- [15] Richard H Middleton and Graham C Goodwin. Adaptive control of time-varying linear systems. *IEEE Transactions on Automatic Control*, 33(2):150–155, 1988.

- [16] Diego Navarro-Tapia, Andrés Marcos, Samir Bennani, Christophe Roux, and ELV SpA. Structured h-infinity and linear parameter varying control design for the vega launch vehicle. In *Proceedings of the 7th European Conference for Aeronautics and Aerospace Sciences (EUCASS)*, 2017.
- [17] J Ocón, FJ Colmenero, J Estremera, K Buckley, M Alonso, E Heredia, J Garciaa, AI Coles, AJ Coles, M Martínez, et al. The ergo framework and its use in planetary/orbital scenarios. In *International Astronautical Congress (IAC)*, pages 1–5, 2018.
- [18] M. Oda, K. Kibe, and F. Yamagata. ETS-VII, space robot in-orbit experiment satellite. pages 739–744, 1996.
- [19] Mark Post, Romain Michalec, Alessandro Bianco, Xiu Yan, Andrea De Maio, Quentin Labourey, Simon Lacroix, Jérémie Gancet, Shashank Govindaraj, Xavier Martinez-Gonzalez, et al. Infuse data fusion methodology for space robotics, awareness and machine learning. In *69th International Astronautical Congress*, 2018.
- [20] M. A. Roa, K. Nottensteiner, A. Wedler, and G. Grunwald. Robotic technologies for in-space assembly operations. In *Symposium on Advanced Space Technologies in Robotics and Automation - ASTRA*, 2017.
- [21] Máximo A Roa, Korbinian Nottensteiner, Gerhard Grunwald, Lopez Negro, Pablo, Aurélien Cuffolo, Sabine Andiappane, Mathieu Rognant, Antoine Verhaeghe, and Vincent Bissonnette. In-space robotic assembly of large telescopes. In *Proc. 15th Symp. Adv. Space Technol. Robot. Autom.*, 2019.
- [22] Lingling Shi, Jayantha Katupitiya, and Nathan Kinkaid. A robust attitude controller for a spacecraft equipped with a robotic manipulator. In *2016 American Control Conference (ACC)*, pages 4966–4971. IEEE, 2016.
- [23] Divya Thakur, Sukumar Srikant, and Maruthi R Akella. Adaptive attitude-tracking control of spacecraft with uncertain time-varying inertia parameters. *Journal of Guidance, Control, and Dynamics*, 38(1):41–52, 2014.
- [24] Robert M Warden. Cryogenic nano-actuator for jwst. In *Proc. 38th Aerospace Mechanisms Symposium*, pages 239–252, 2006.