



HAL
open science

Analyse et Visualisation de structures 2D d'ARN

Fabrice Leclerc

► **To cite this version:**

Fabrice Leclerc. Analyse et Visualisation de structures 2D d'ARN. Master. Paris, France. 2020.
hal-03313812

HAL Id: hal-03313812

<https://hal.science/hal-03313812>

Submitted on 4 Aug 2021

HAL is a multi-disciplinary open access archive for the deposit and dissemination of scientific research documents, whether they are published or not. The documents may come from teaching and research institutions in France or abroad, or from public or private research centers.

L'archive ouverte pluridisciplinaire **HAL**, est destinée au dépôt et à la diffusion de documents scientifiques de niveau recherche, publiés ou non, émanant des établissements d'enseignement et de recherche français ou étrangers, des laboratoires publics ou privés.

Public Domain

Echelles de taille et complexité

longueur, repliements (jonctions), interactions à longue distance

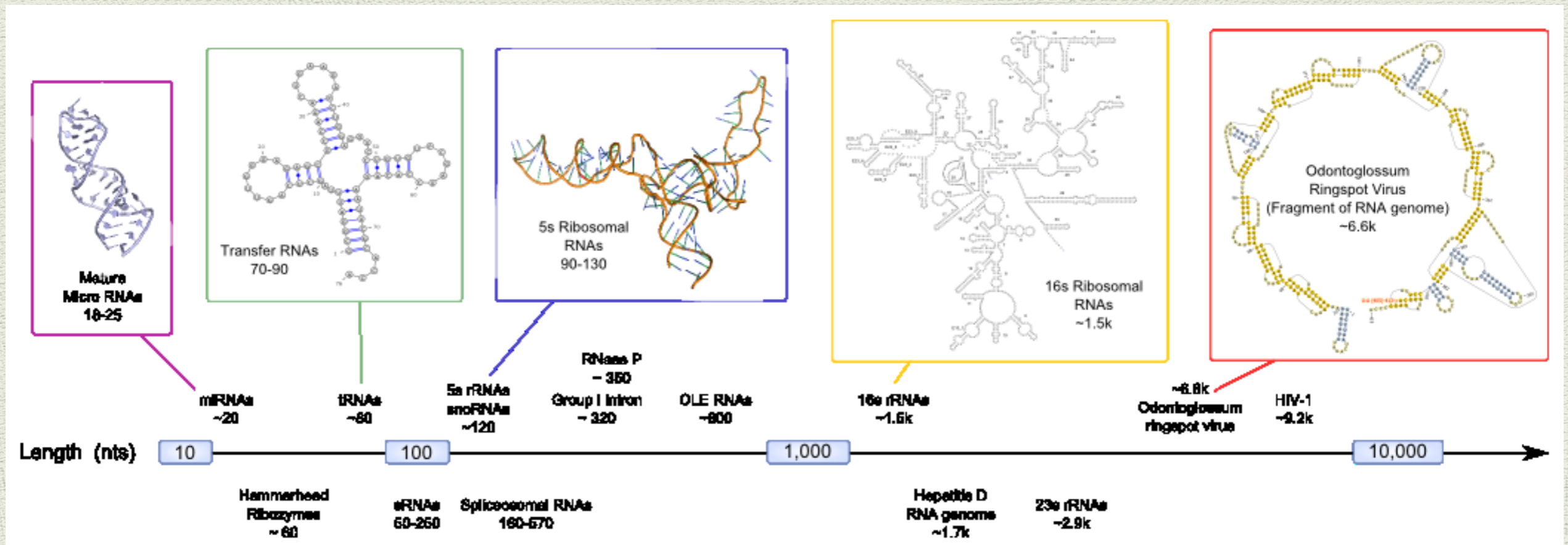

VARNA, S2S, etc

RNAfdl
(intersection-free)

Motifs ARN

Représentations 2D

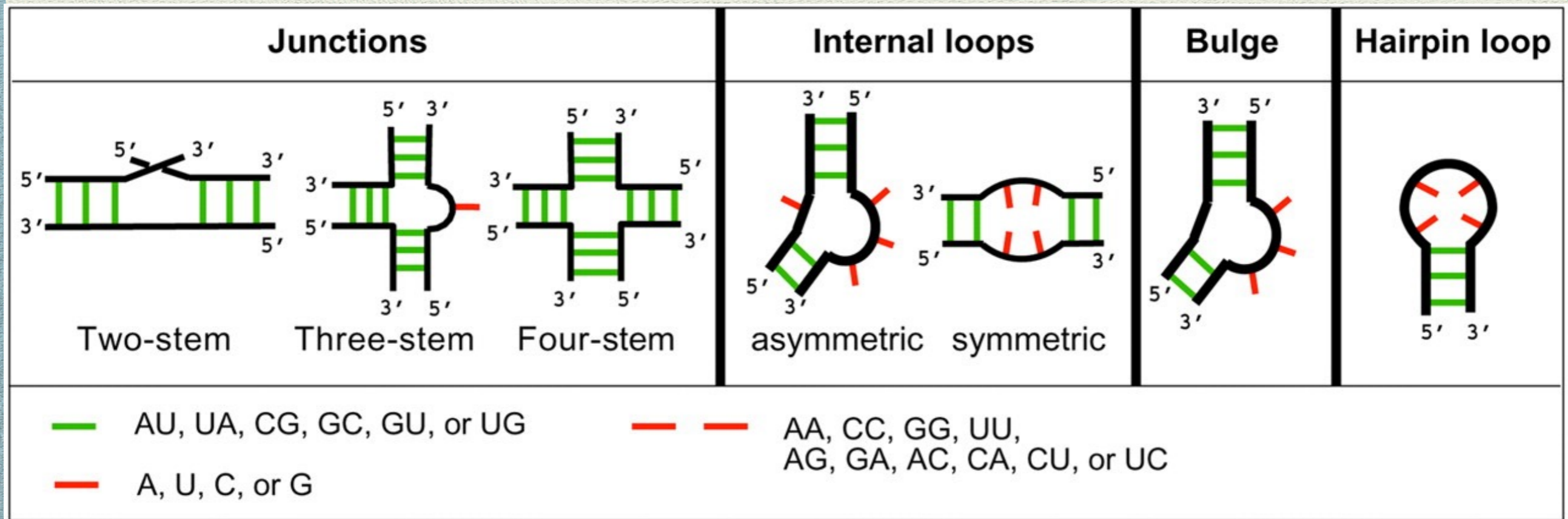

ARN simple brin / ARN double brin
 fonction / structure

Jonctions: « 3-way »

Représentations 2D (3D)

Une jonction

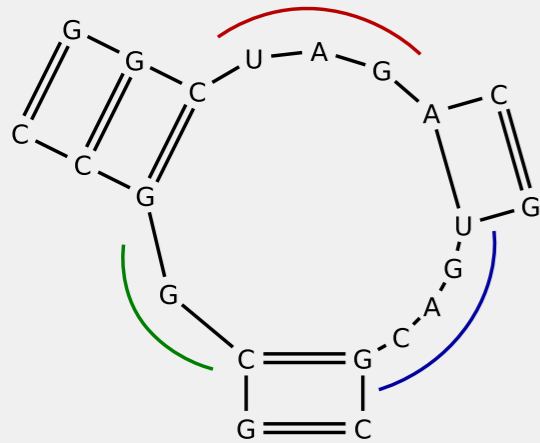

Trois empilements

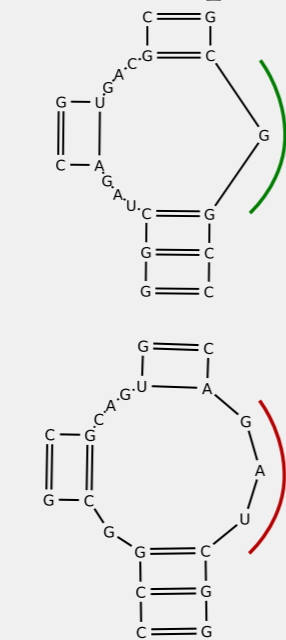

Neuf configurations

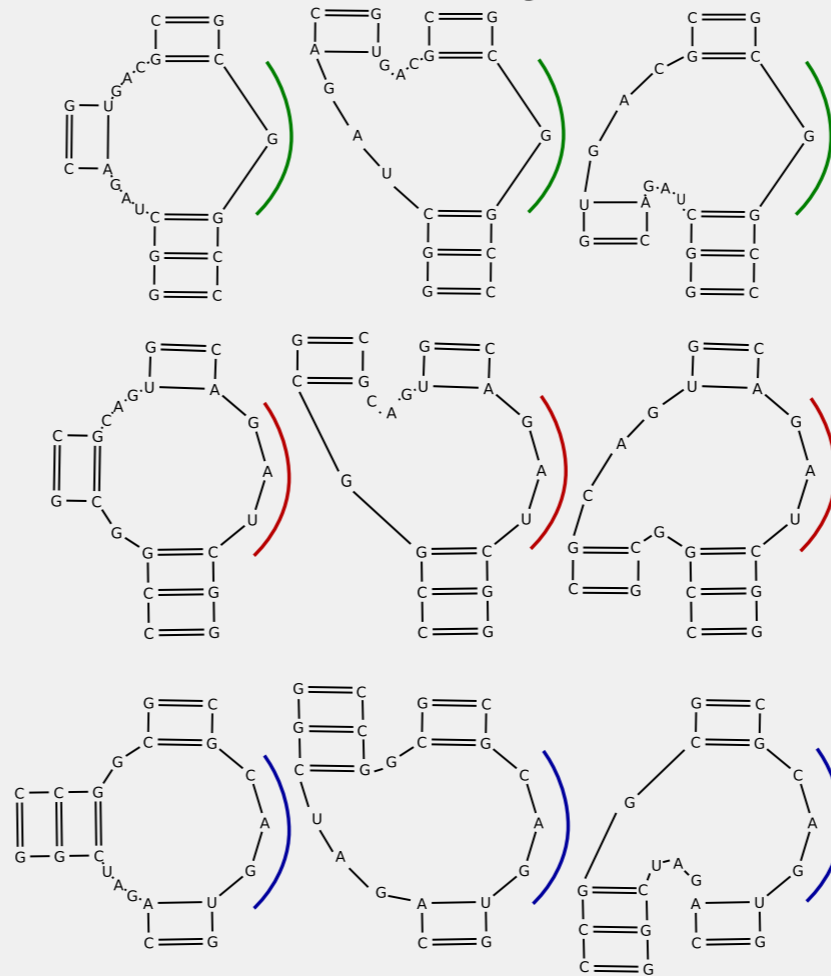

Pour chaque configuration, un score

Empil.	Famille	Score
1	A	2,12
1	B	0,23
1	C	0,85
2	A	1,5
2	B	0,12
2	C	0,01
3	A	1,3
3	B	0,1
3	C	1,1

Le meilleur score est notre prédiction

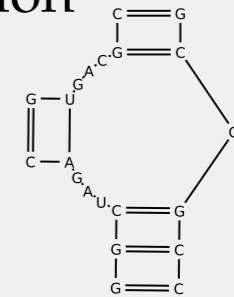

Jonctions: « 4-way »

Représentations 2D (3D)

Famille H

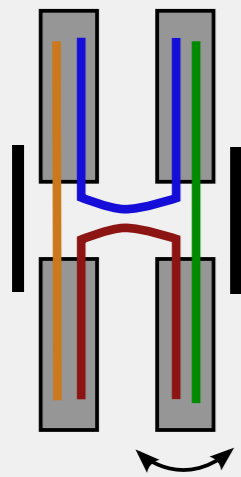

Famille π

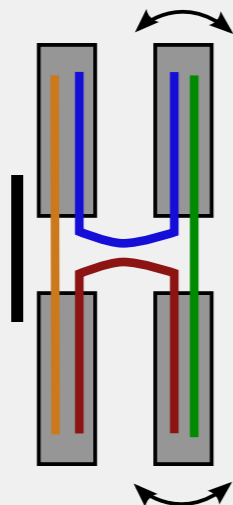

Famille cH

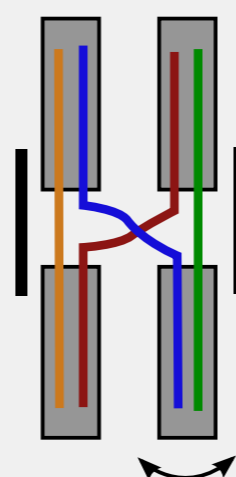

Famille cL

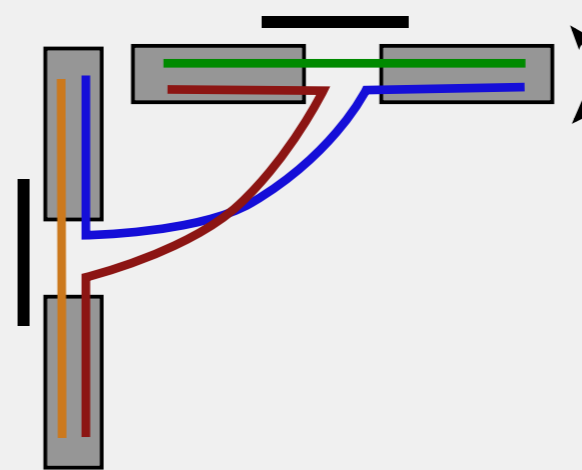

Famille cW

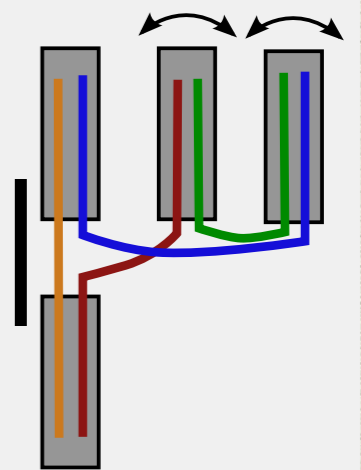

Famille cK

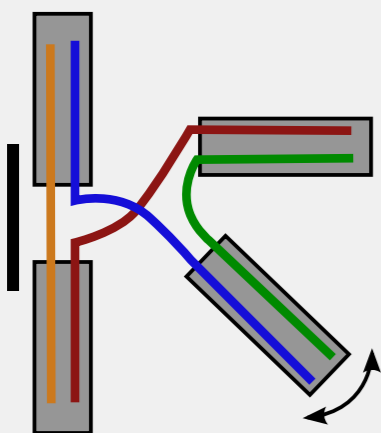

Famille X

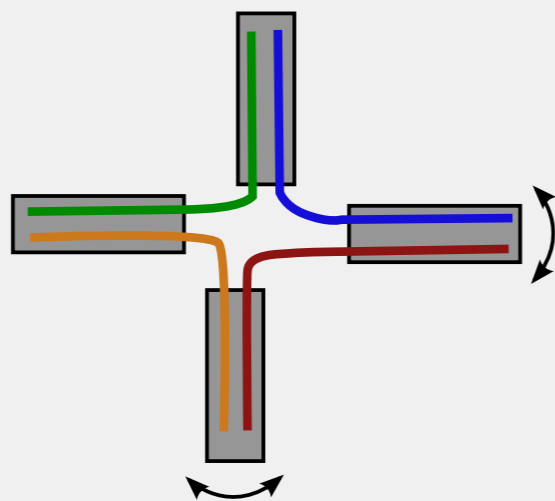

Famille ψ

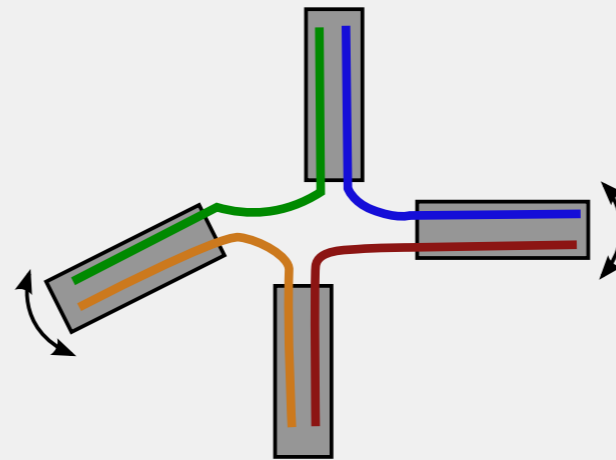

Famille cX

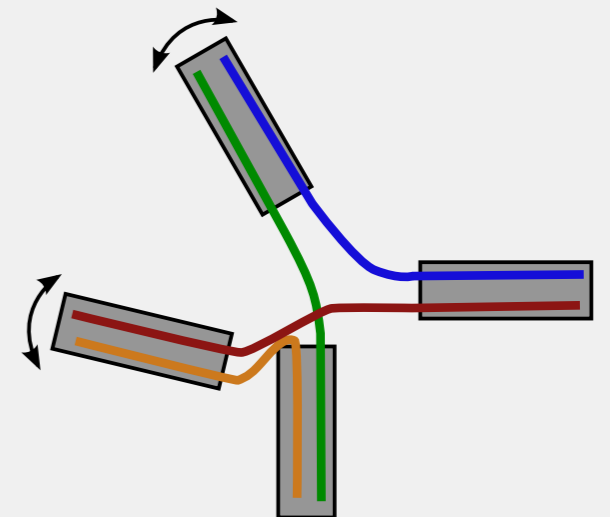

Structure modulaire

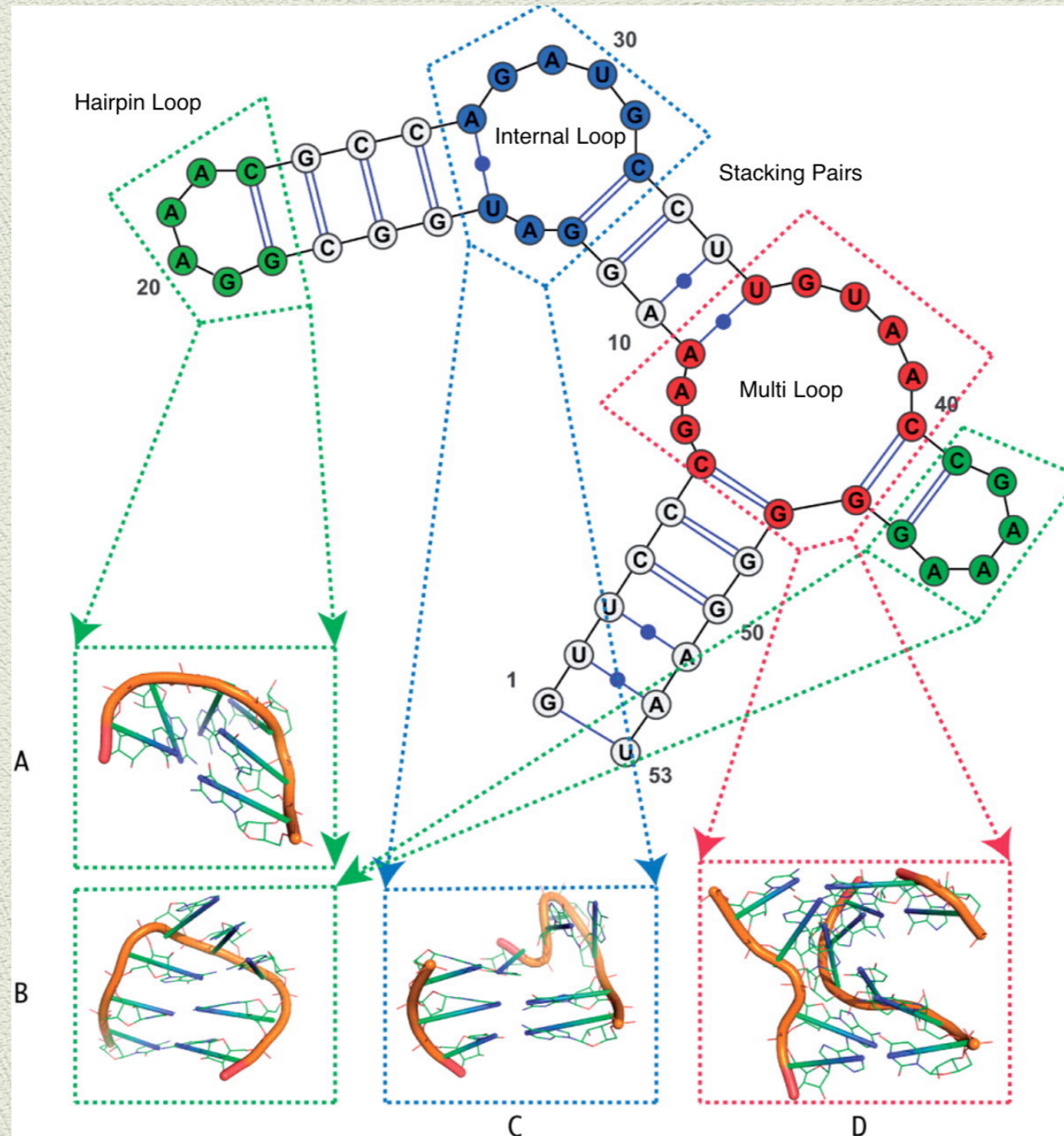

Motifs: structure & fonction

A. RNA structural motifs

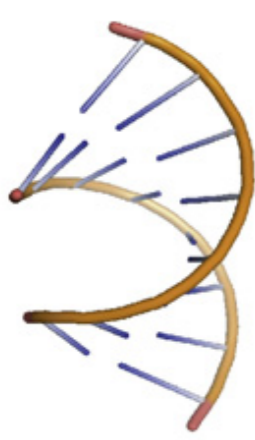

Watson-Crick (WC)

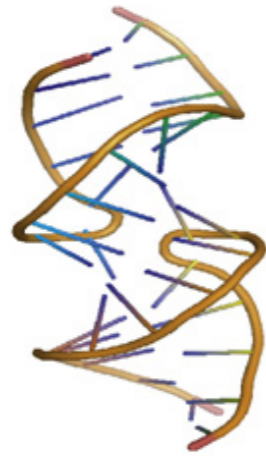

kissing-loop



loop-receptor (LR)

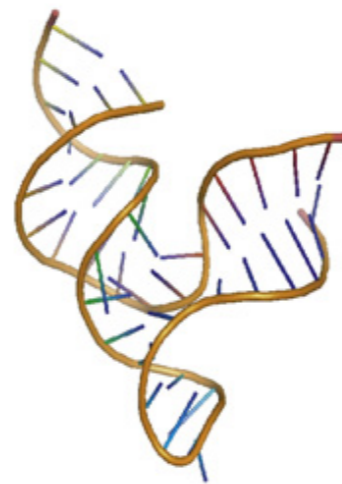

three-way junction

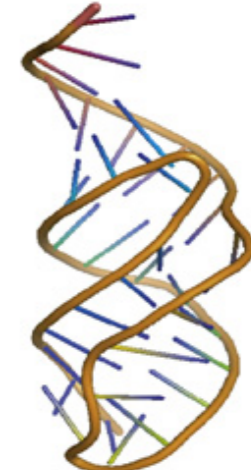

pseudoknot

B. RNP interacting motifs



ssRNA

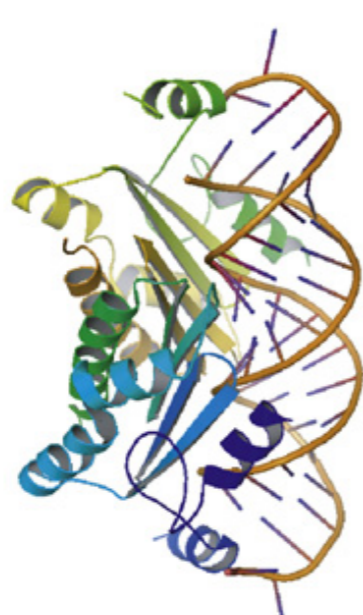

dsRNA

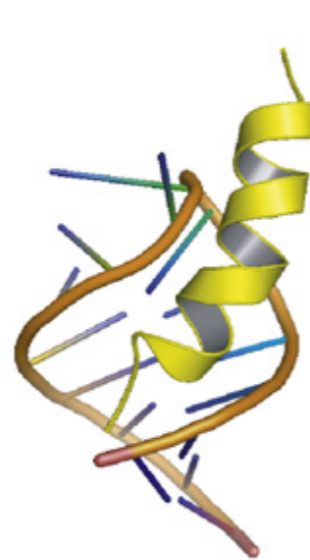

stem-loop

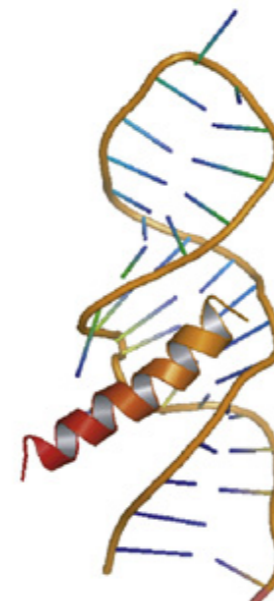

internal-loop



kink-turn

ARNr 16S

Secondary Structure: small subunit ribosomal RNA

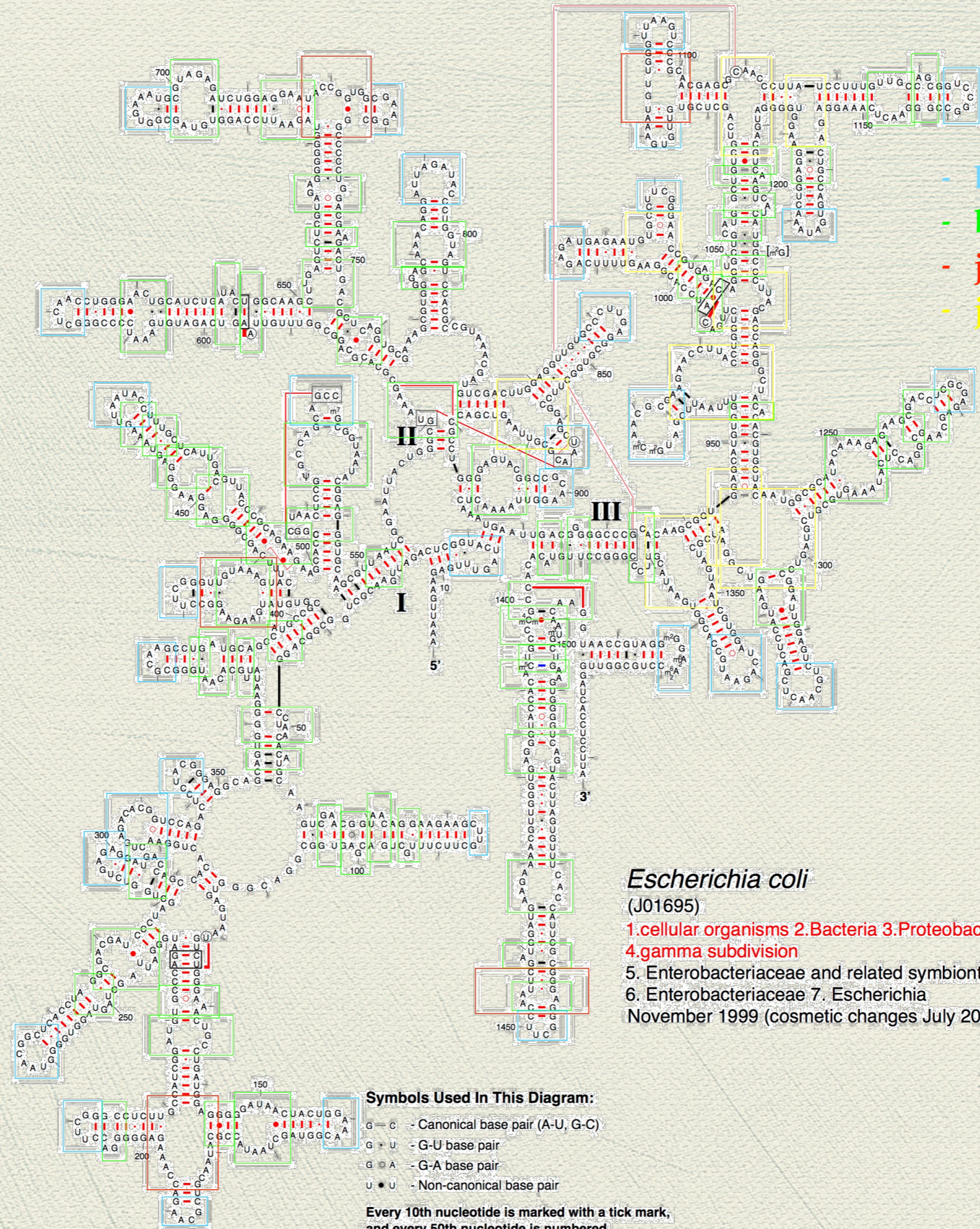

- boucles terminales
- boucles internes/bulges
- jonctions 3
- jonctions n

Escherichia coli

(J01695)

1. cellular organisms 2. Bacteria 3. Proteobacteria

4. gamma subdivision

5. Enterobacteriaceae and related symbionts

6. Enterobacteriaceae 7. Escherichia

November 1999 (cosmetic changes July 2001)

ARNr 16S

Secondary Structure: small subunit ribosomal RNA

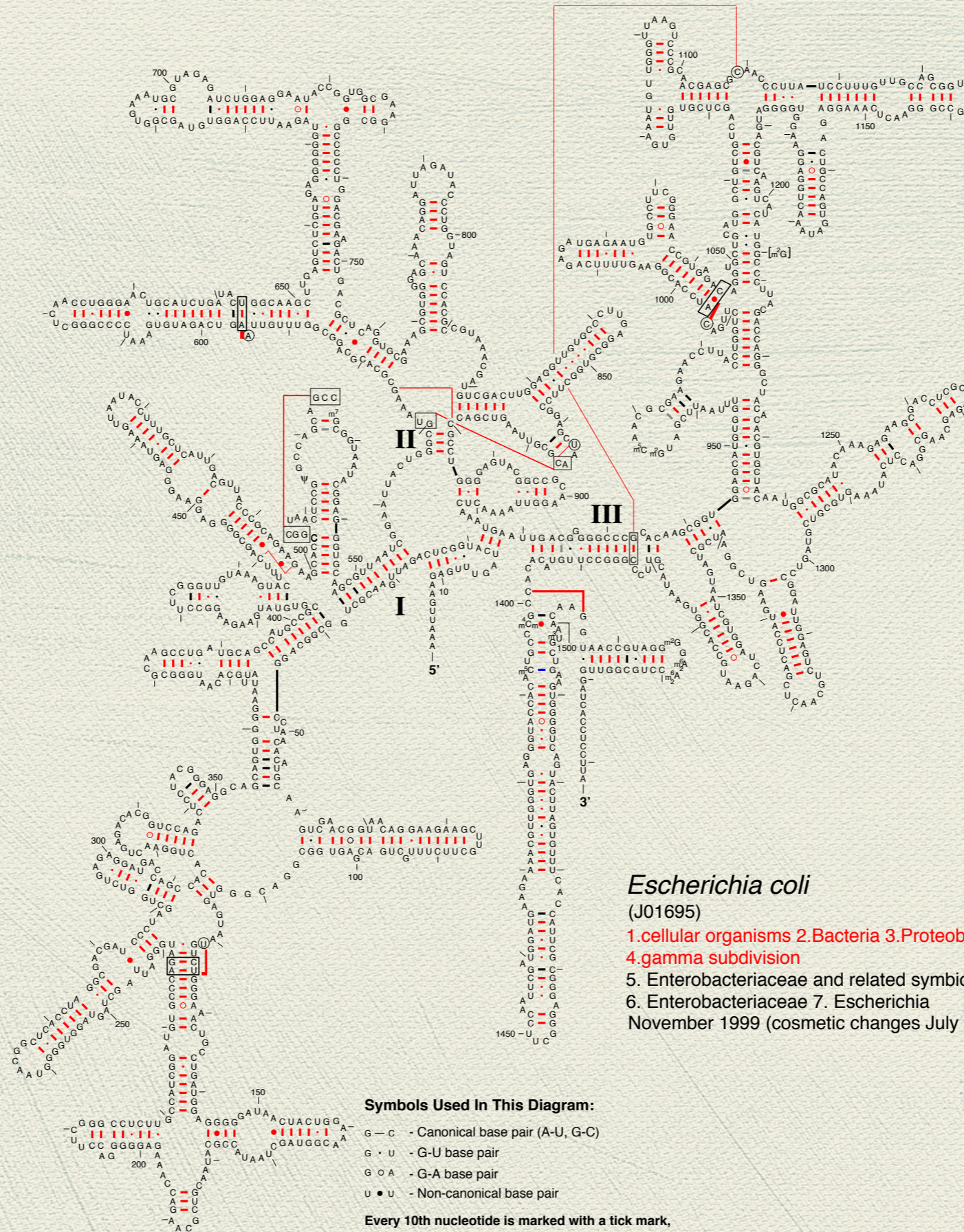

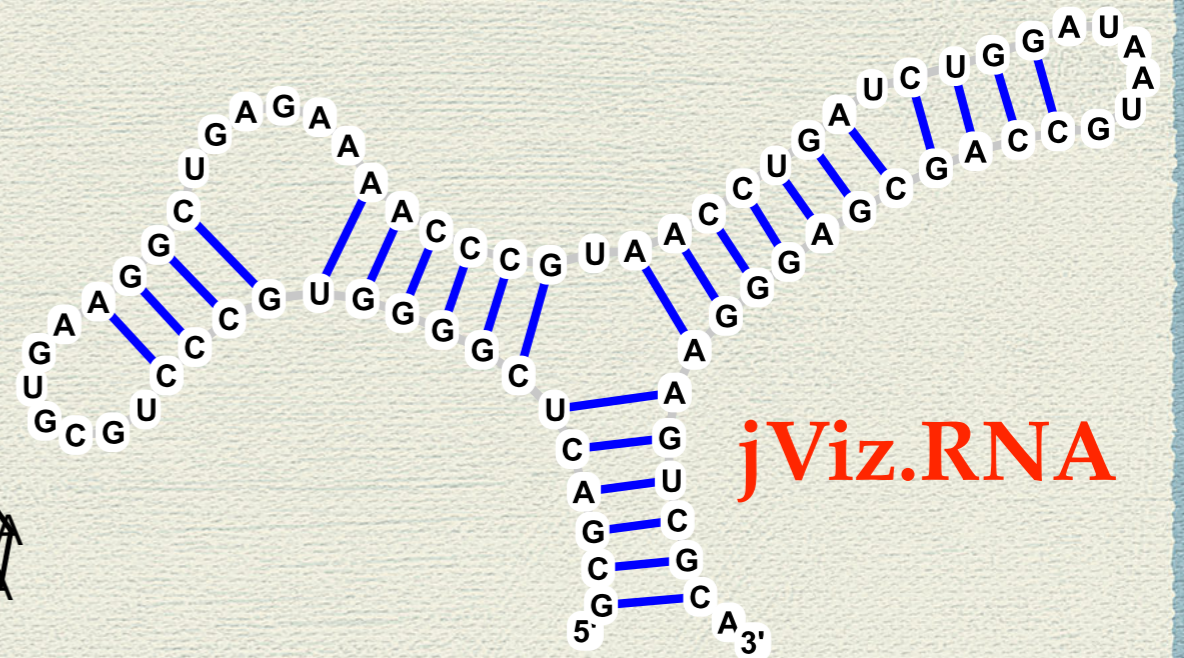
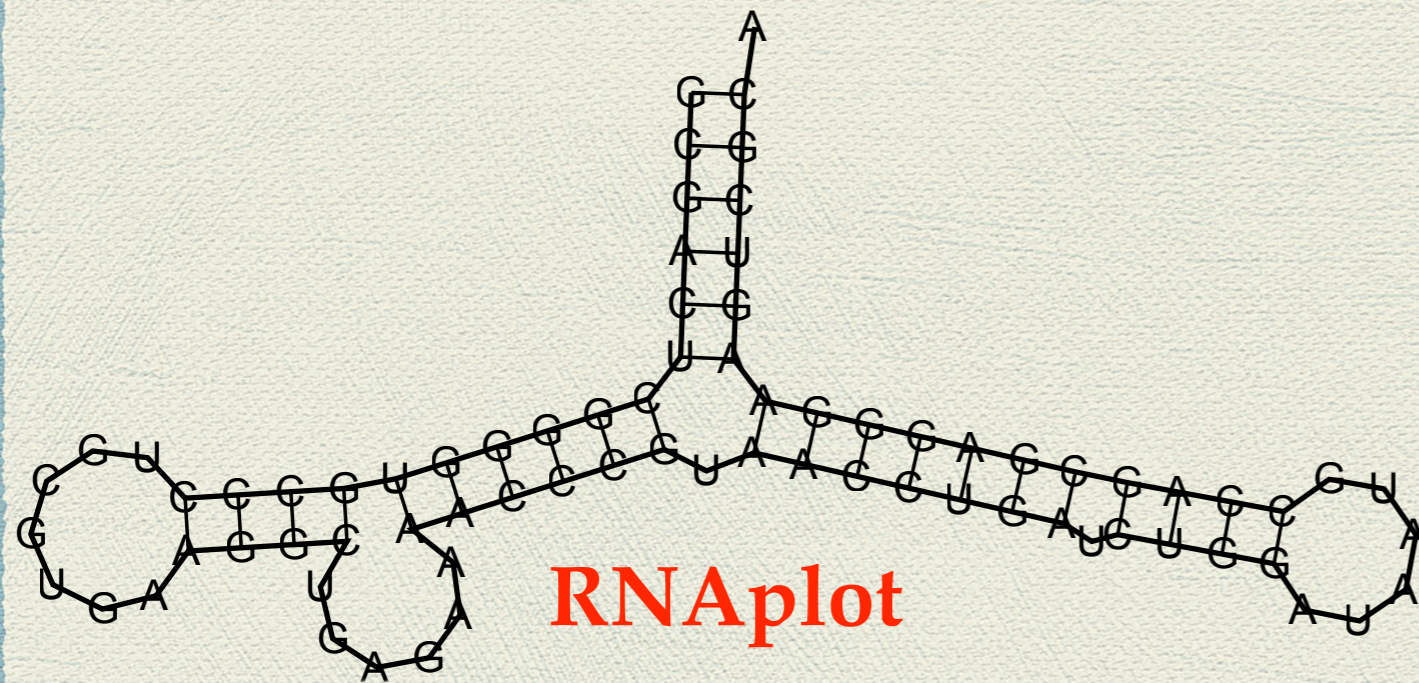

- ◆ modèles 2D (expérimental: « footprinting », fluorescence, SHAPE, etc; théoriques: MFold, RNAfold, etc)
- ◆ représentations 2D à partir de structures 3D d'ARN
- ◆ annotations des structures avec des informations: structurales, fonctionnelles, phylogénétiques, etc

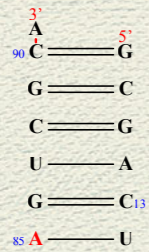

S2S/Assemble

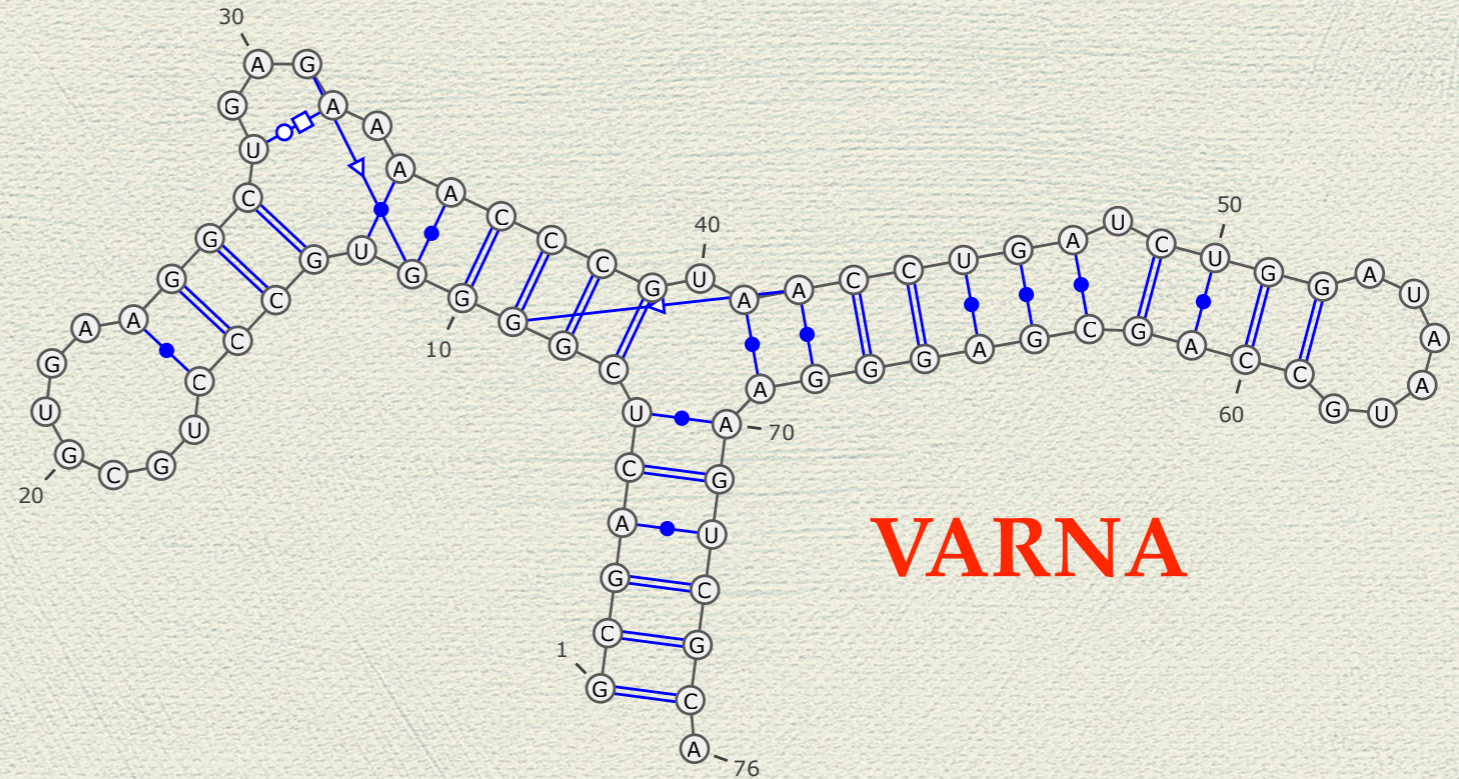
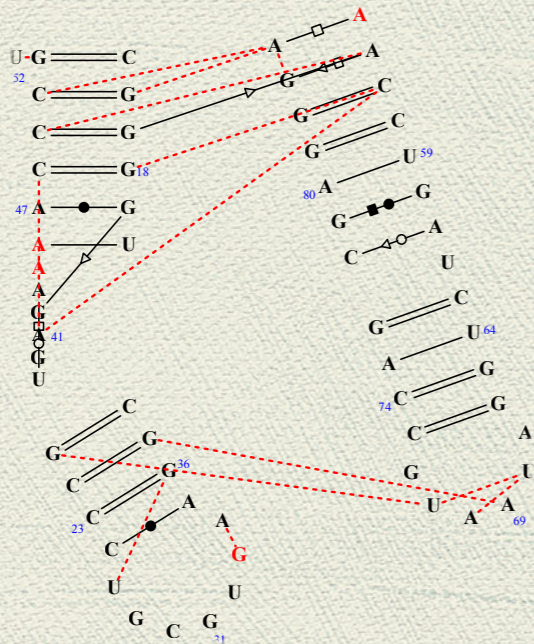

VARNA

- modèles 2D (expérimental: « footprinting », fluorescence, SHAPE, etc; théoriques: MFold, RNAfold, etc)
- représentations 2D à partir de structures 3D d'ARN
- annotations des structures avec des informations: structurales, fonctionnelles, phylogénétiques, etc

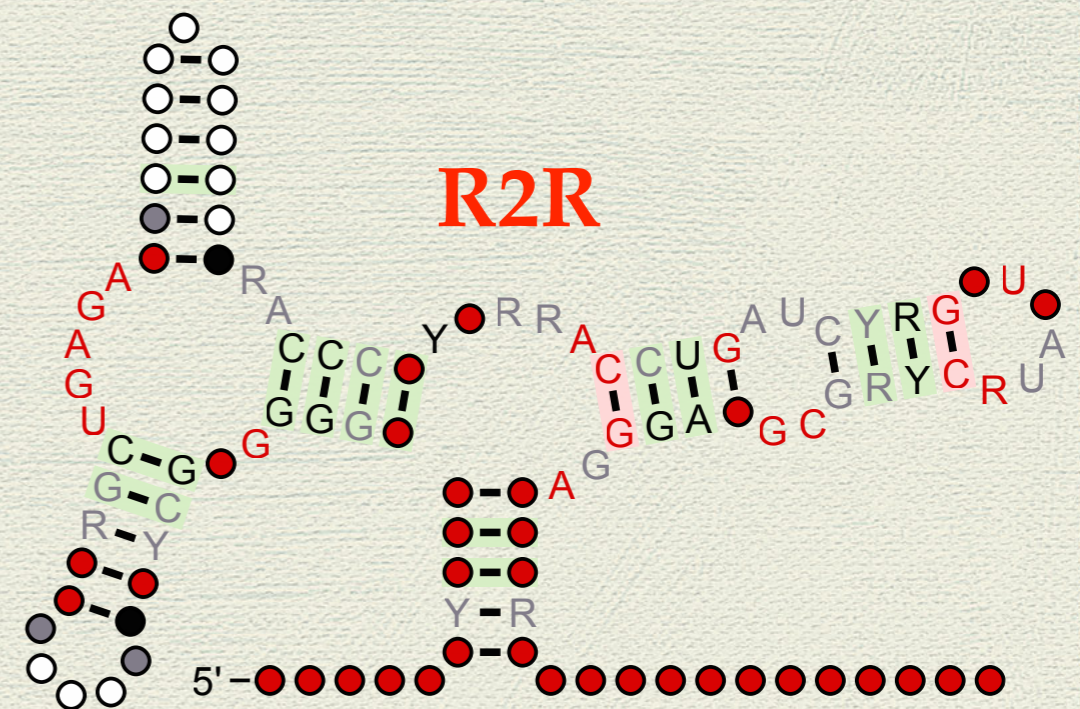
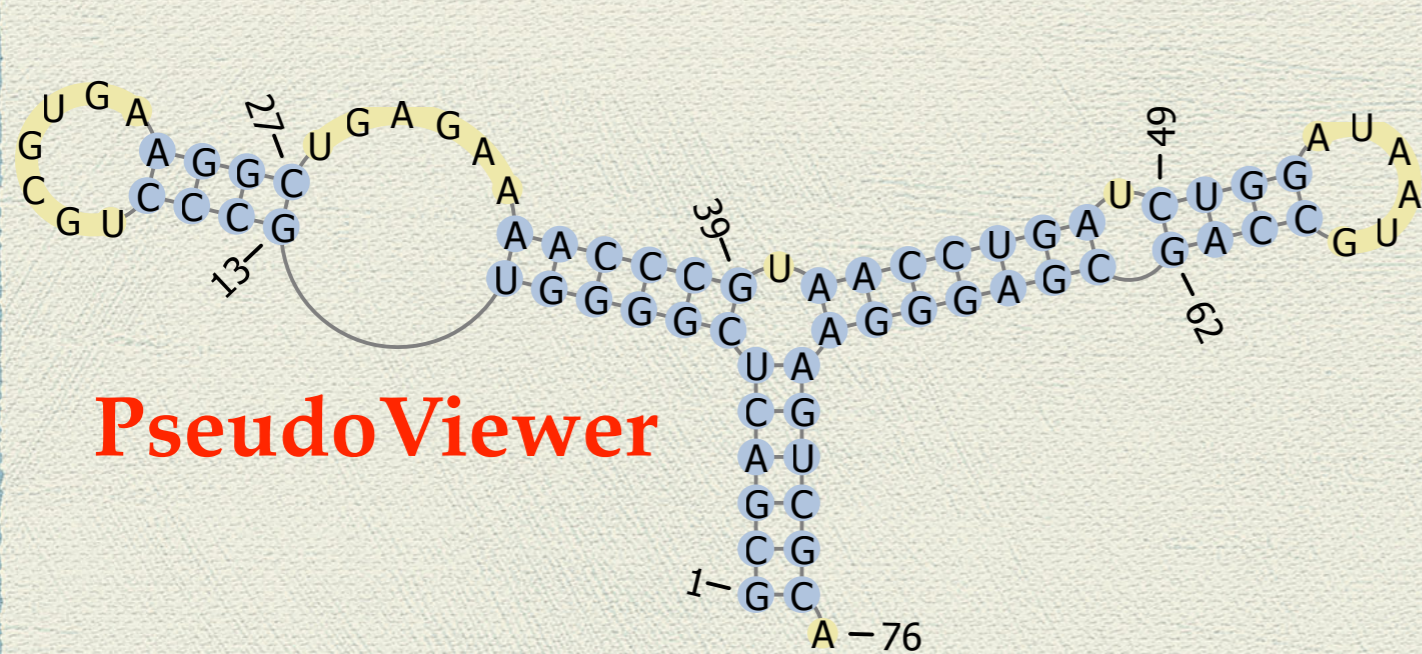

- ◆ modèles 2D (expérimental: « footprinting », fluorescence, SHAPE, etc; théoriques: MFold, RNAfold, etc)
- ◆ représentations 2D à partir de structures 3D d'ARN
- ◆ annotations des structures avec des informations: structurales, fonctionnelles, phylogénétiques, etc

RNA 2D Structure by HT-SHAPE

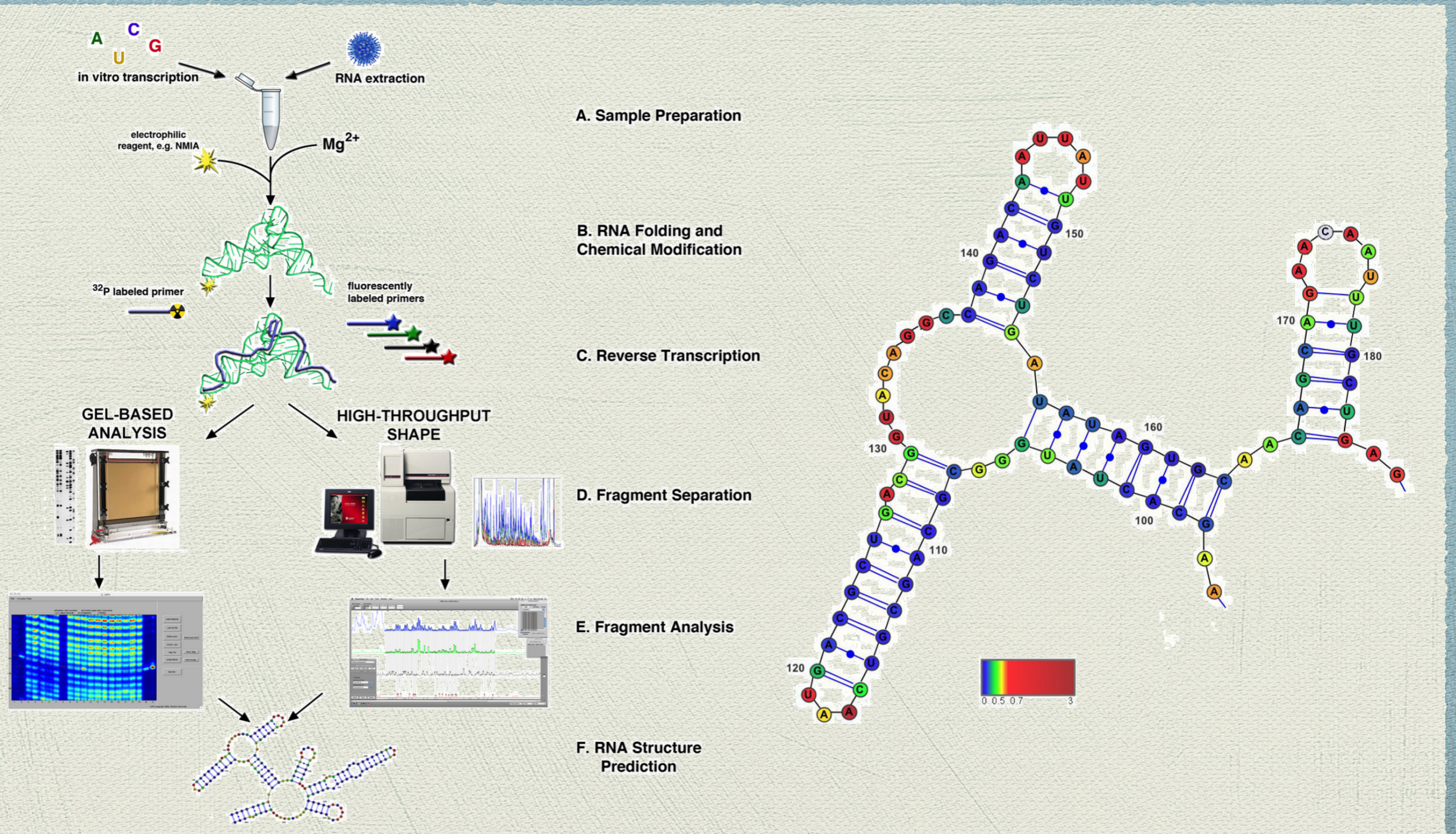

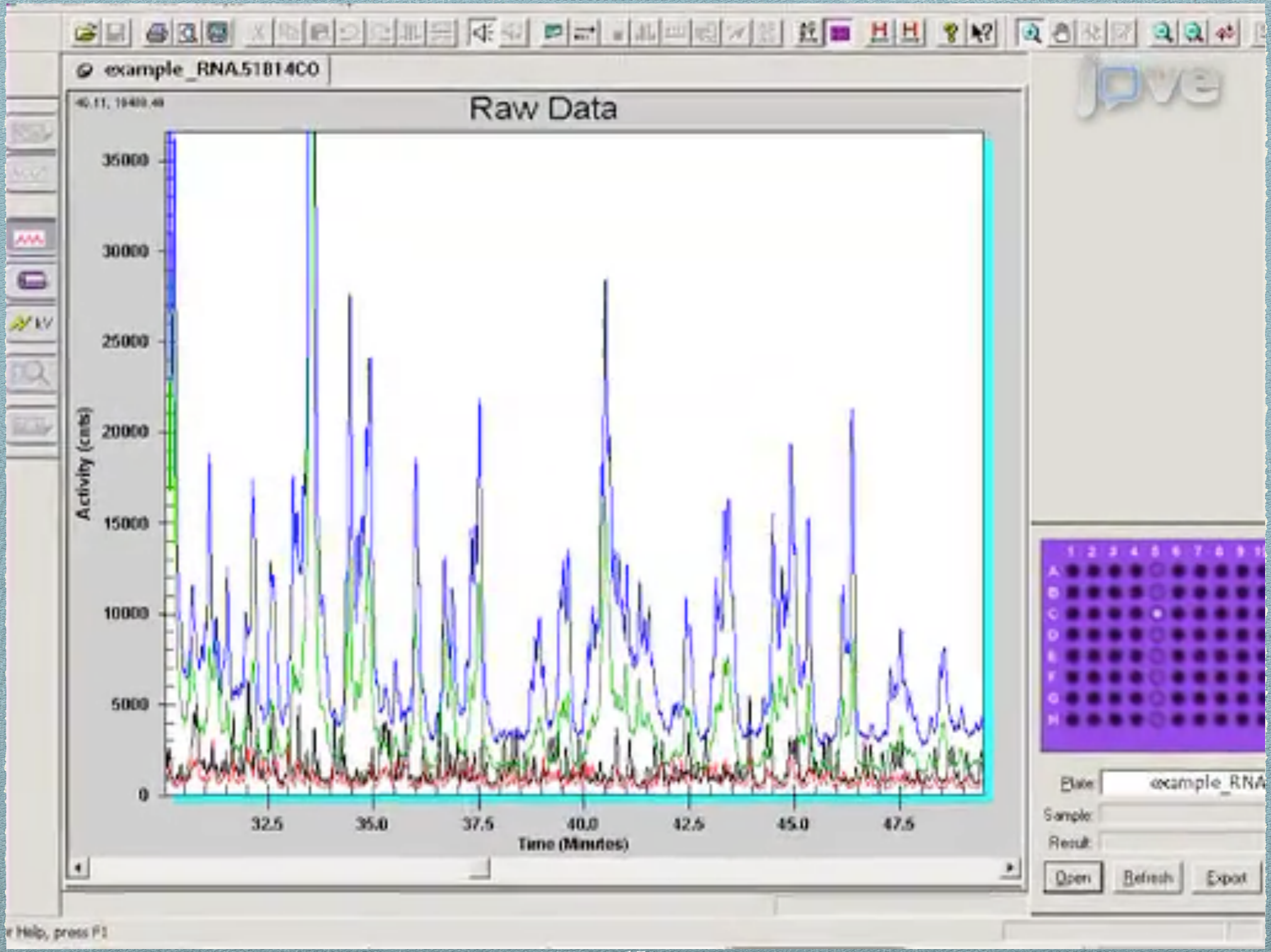

IUPAC nucleotide code

Single-letter Code	Nucleotide/s	Explanation
A	A	A denine
C	C	C ytosine
G	G	G uanine
T / U	T / U	T hymine / U racile
I	I	I nosine
R	A or G	p u R ine
Y	C or T / U	p Yrimidine
M	A or C	a Mino
K	G or T / U	K eto
S	C or G	S trong interaction
W	A or T / U	W eak interaction
H	A or C or T / U	not G, H follows G in alphabet
B	C or G or T / U	not A, B follows A in alphabet
V	A or C or G	not T/U, V follows U in alphabet
D	A or G or T / U	not C, D follows C in alphabet
N	A or C or G or T/U	a Ny

Table 1. IUPAC system for nucleotide nomenclature

A Raw Data

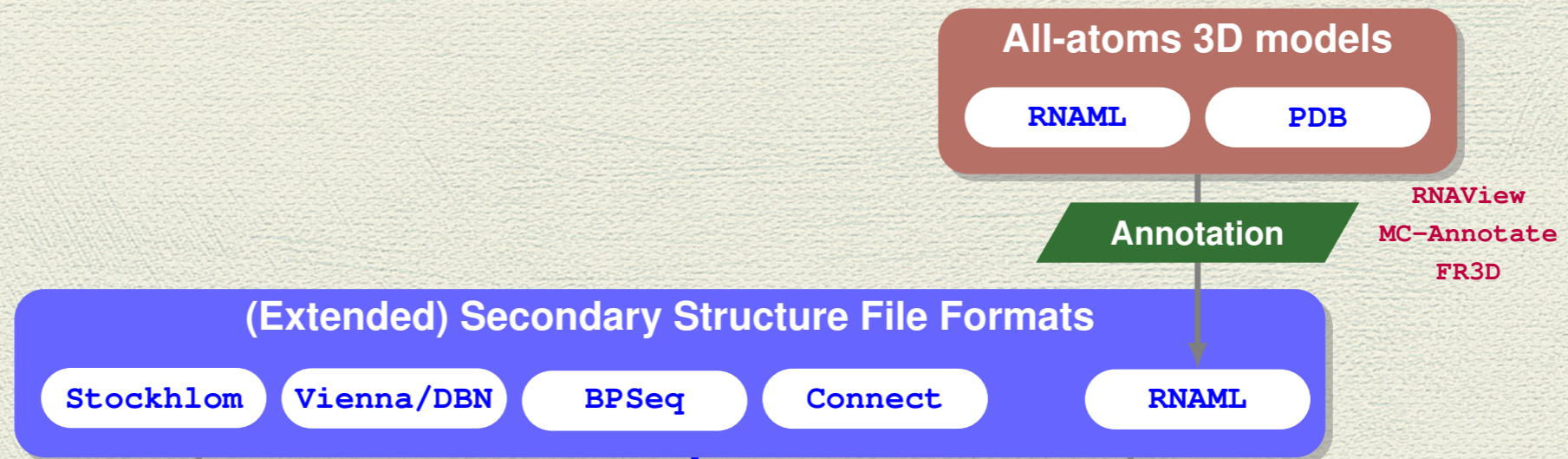

B RNA-Aware Tools

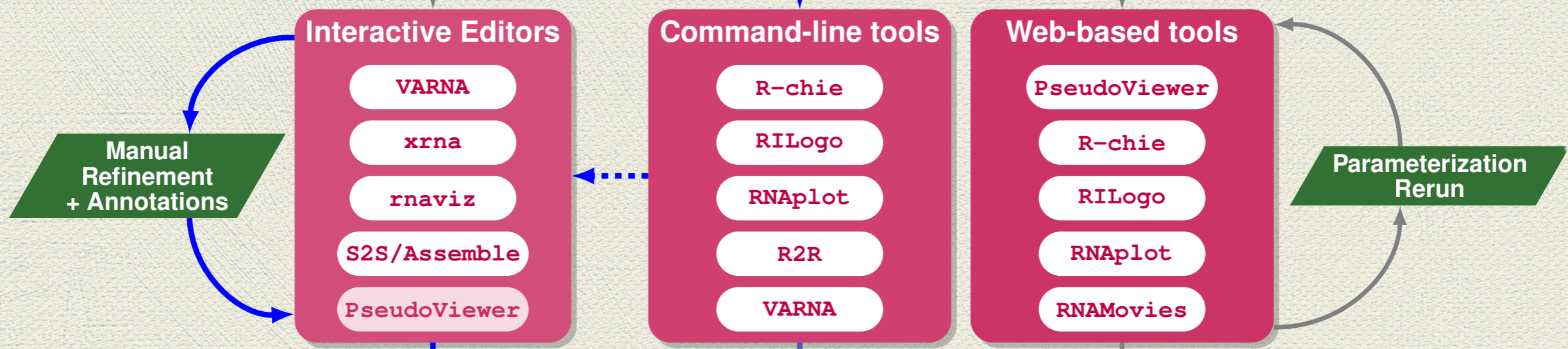

C Post-Processing

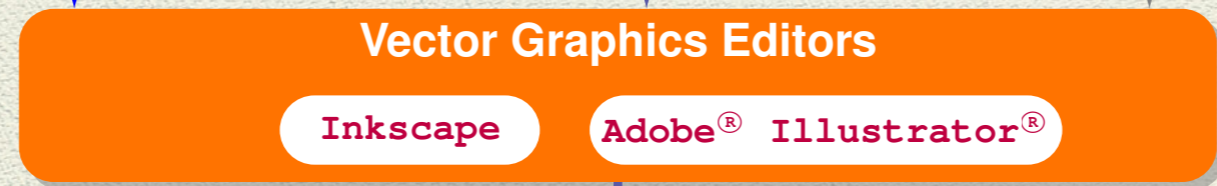

D Rasterization (Optional)

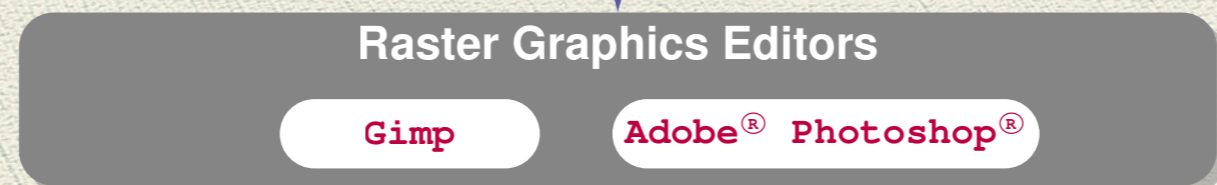

Rougier, JDEV2013

Formats et Outils

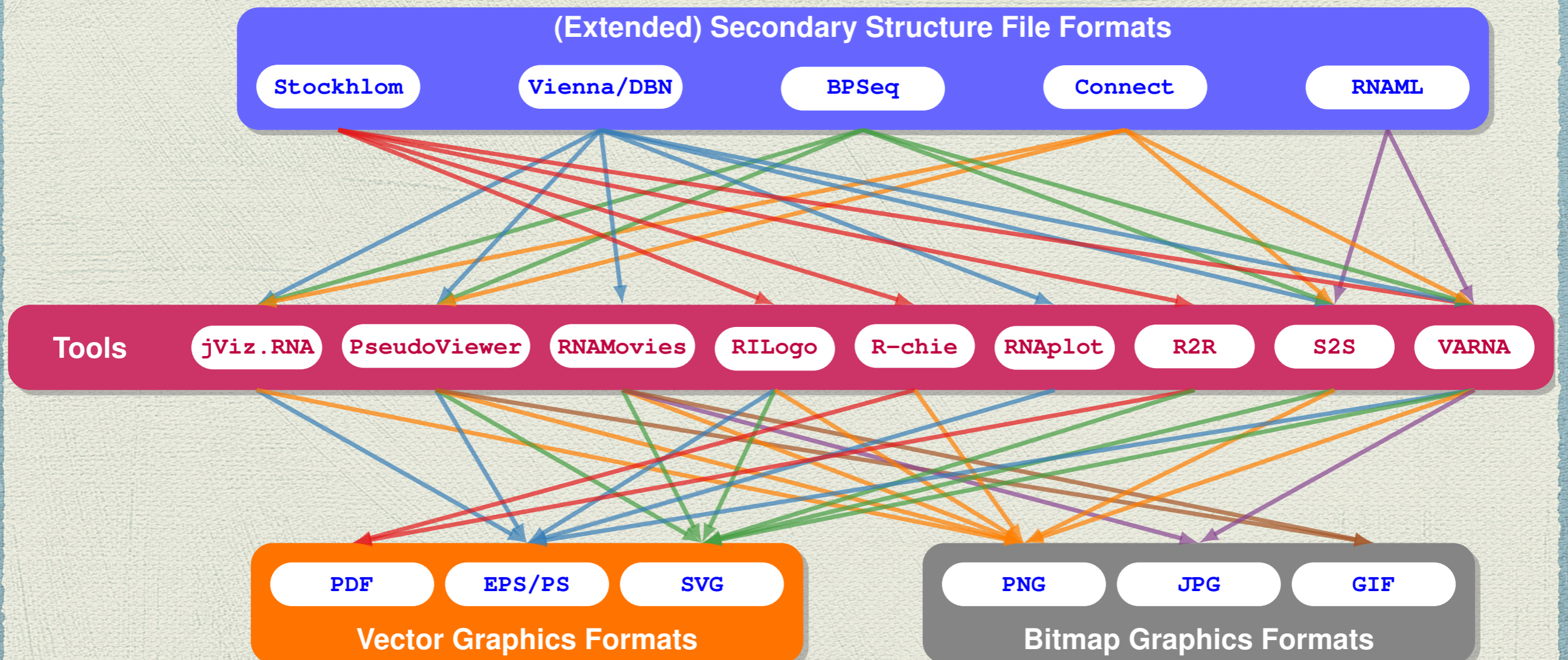

A

```

>O.sativa.1 AJ489954.1/1-104
.....UGGCUGAGACGACUAGGUGAAAUU.CAAGCUCAACAGACCAAUACAGGUCUC
..UCUCCAAGGCCUU.UGGAGAUUGGAUCUGUAUGCCGA.....GU..UUCCGCUC....
.AGCCG.....
>O.sativa.2 AY013245.2/61987-62105
....GAUGGCAGUGACGACUUGGUAUAUUU.CAAGCUCAACAGACCAAUACAGGUCUU
CCUCUCUGGAUCCAC..UCCUCUGGGAUUGAUUUUG..UAUGCCGAUUUUUCCGCUGAAC
GAGCCAUC....
>O.sativa.3 AJ307928.1/3-121
....GAUGGCAGUGACGACCUGGUAUAUUU.CAAGCUCAACAGACCAAUACAGGUCUU
..UCUCUCUGGAUCUACUCCUCAGGGAUUGAUUUUG..UAUGCCGAUUUUUCCGCUGAAC
GAGCCAUC....

```

B

CLUSTAL 2.1 multiple sequence alignment

```

M.musculus.1   UGGCCUCGUUCAAGUAAUCCAGGAUAGG--CU--GUG-CAGGUCCAAGGGGCCUAUUCU 55
H.sapiens.2   UGGCCUCGUUCAAGUAAUCCAGGAUAGG--CU--GUG-CAGGUCCAAGGGGCCUAUUCU 53
H.sapiens.3   GGACCCAGUUCAAGUAAUCCAGGAUAGGUUGU--GUG-CUGU--CCAG----CCUGUUCU 51
T.rubripes.1  CAACCGGGUUCAAGUAAUCCAGGAUAGGGUCU--GUUCUGU--CUUGG---CCUAUCU 53
H.sapiens.1   UGGCUGGAUUCAAGUAAUCCAGGAUAGGGUCU--G-AGG---CCUAUUCU 54
..*  .***** ***** *  . * *      .   **.* **

M.musculus.1   UGGUUACU---UGCACGGGGAC 74
H.sapiens.2   UGGUUACU---UGCACGGGGAC 72
H.sapiens.3   CCAUUACU--UGGCUCGGGGAC 71

```

A: FASTA (aligned)**B: CLUSTAL****F**

```

Filename: AM286415_b.bpseq
Organism: Yersinia enterocolitica subsp. enterocolitica 8081
Accession Numbers: AM286415
Citation and related information available at http://www.rna.cccb.utexas.edu
1 u 0
...
117 u 0
118 U 236
119 G 235
120 C 234
121 C 233
122 U 232
123 G 231
124 G 230
...
230 C 124
231 C 123
232 A 122
233 G 121
234 G 120
235 C 119
236 A 118
...

```

G

```

80      dG = -33.48 [Initially -35.60]
1       U       0       2       80      1
2       G       1       3       79      2
3       G       2       4       78      3
4       G       3       5       77      4
5       A       4       6       76      5
6       U       5       7       0       6
7       G       6       8       75      7
...
75      U       74       76       7       75
76      U       75       77       5       76
77      C       76       78       4       77
78      C       77       79       3       78
79      U       78       80       2       79
80      A       79       0        1       80

```

C

```

# STOCKHOLM 1.0
#=GF ID      mir-22
#=GF AC      RF00653
...
O.latipes.1       CGUUG.CCUCACAGUCGUUCUUA.CUGGCU.AGCUUUUAUGUCCACG..
Gasterosteus_aculeat.1 GGCUG.ACCUACAGCAGUUCUUA.CUGGCA.AGCUUUUAUGUCCUCAUCU
R.esox.1          AGCUGAGCACA...CAGUUCUUA.CUGGCA.GCCUUAAAGGUUCUGUAG
...
#=GC SS_cons     .<<<<<. <<<. <<<<<<<<<<<<<<<<<<<<<<<<<<<<<. <<<<<<. <<<<<<<<. <<<.....
#=GC RF          gGccg.acucaCagcaGuuCuuCa.cuGGCA.agCuuuAuguccuuauaa

O.latipes.1       CCCCACCGUAAAGCU.GC.CAGUUGAAGAGCUGUUGUG..UGUAACC
Gasterosteus_aculeat.1 ACCAGC..UAAAGCU.GC.CAGCUGAAGAACUGUUGUG..GUCGGCA
R.esox.1          ACAGGC..UAAACCU.GC.CAGCUGAAGAACUGCUCUG..GCCAGCU
...
#=GC SS_cons     ....>>..>>>>>>>>. >>. >>. >>>>>>>>>>>>>>>>>>>>>>>>>>>>>>>>. >>>>>>>>.
#=GC RF          acaaac..UaaaGCu.GC.CaGuuGaaGaaCugcuGug..gucgGcU
//

```

D

```

> Rat Alanine tRNA
GAGGAUUUAGCUUUUUUUAAAGCAGUUGAUUUUGCAUUUAAACAGAUGUAAGAUUAGUCUUACAGUCCUUA
(((((((...(((...)))).((((...)))))...(((((((...)))))...)))))))).

```

E

```

          1590      1600      1610      1620      1630
#         |123456789|123456789|123456789|123456789|123456
$ 1590   AAAAAACUAAUAGAGGGGGGACUUAGCGCCCCCAAACCGUAACCCC=1636
% 1590   ::::::::::::::[[[[[[:::(([]]]]:::))]:::

```

C: Stockholm (RFAM)**D: Vienna (RNAfold)****E: Pseudobase****F: BPSEQ****G: CONNECT (CT, CT2)**

Notation « dot-bracket »

> Rat Alanine tRNA

GAGGAUUUAGCUUAAUUAAGCAGUUGAUUUGCAUUUAACAGAUGUAAGAUUAGUCUUACAGUCCUUA

(((((...(((.....))))).(((.....)))))...(((.....)))))))).

Vienna, DBN

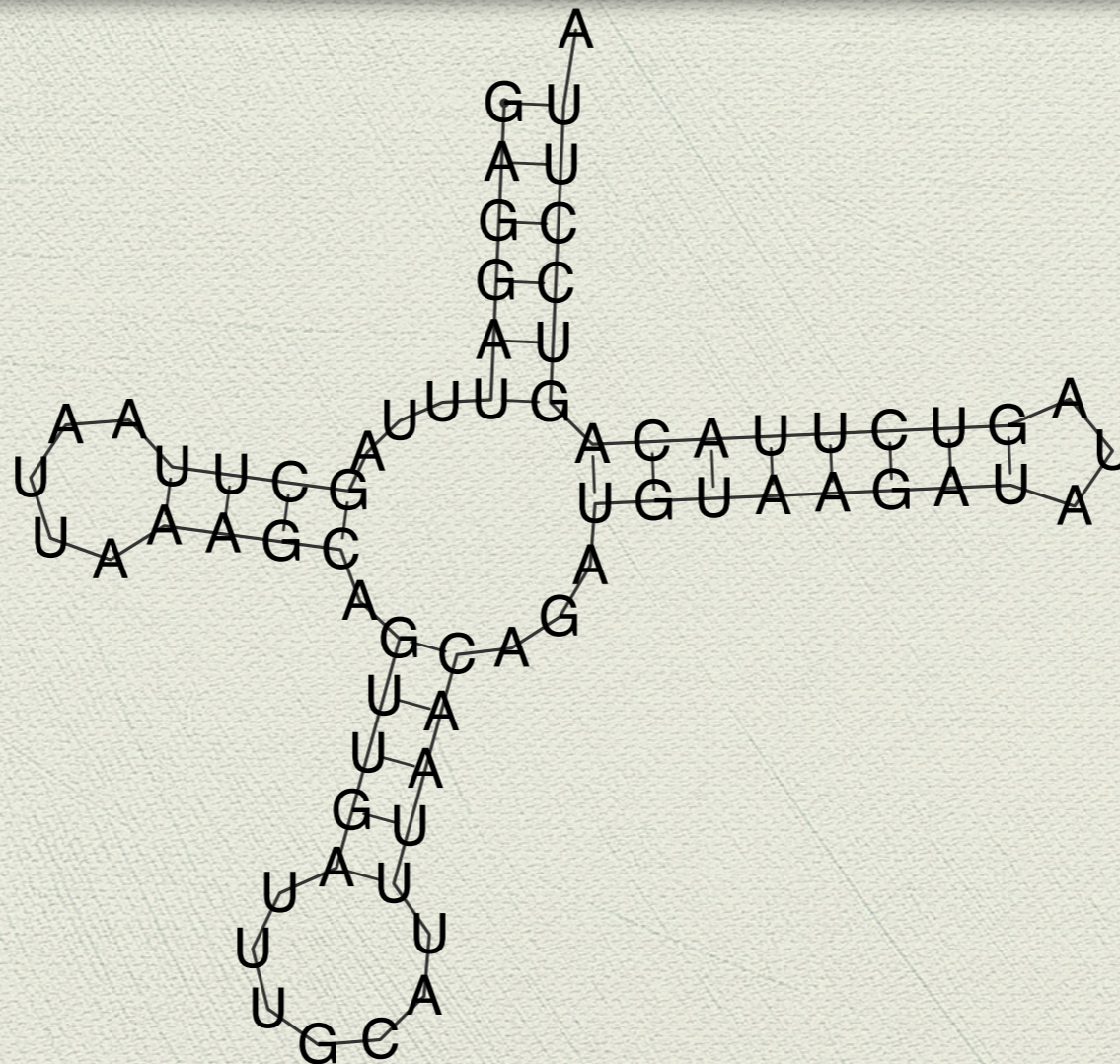

Format Stockholm

```
# STOCKHOLM 1.0
#=GF ID      mir-22
#=GF AC      RF00653
...
O.laticipes.1      CGUUG.CCUCACAGUCGUUCUUCA.CUGGCU.AGCUUUAUGUCCCACG..
Gasterosteus_aculeatus.1  GGCUG.ACCUACAGCAGUUCUUCA.CUGGCA.AGCUUUAUGUCCUCAUCU
R.esox.1          AGCUGAGCACA...CAGUUCUUCA.CUGGCA.GCCUUAAGGUUUCUGUAG
...
#=GC SS_cons      .<<<<<. <<. .<<<<<<<<<<<<<<<<<<. .<<<<<. .<<<<<<<<. <<. . . . . . . . . . .
#=GC RF           gGccg.acucaCagcaGuuCuuCa.cuGGCA.aGCuuuAuguccuuauaa

O.laticipes.1      CCCACCGUAAAGCU.GC.CAGUUGAAGAGCUGUUGUG..UGUAACC
Gasterosteus_aculeatus.1  ACCAGC..UAAAGCU.GC.CAGCUGAAGAACUGUUGUG..GUCGGCA
R.esox.1          ACAGGC..UAAACCU.GC.CAGCUGAAGAACUGCUCUG..GCCAGCU
...
#=GC SS_cons      . . . . .>>. .>>>>>>>. >>. >>. .>>>>>>>>>>>>>>>>>. . .>>>>>>.
#=GC RF           acaaac..UaaaGCu.GC.CaGuuGaaGaaCugcuGug..gucggCu
//
```

Stockholm - Ralee (emacs)

```
# STOCKHOLM 1.0
```

```
Pho21_215834-215776_ -__ CGGCCCGGTTCCCGCCCTCTCCGGGGAATCGTGAACCGGGGGTTC CGACCGGGCCGACA  
Pfu21_163991-163933_ -__ GGGCCCGGTTCCCGCCCTCTCCGGGGAATCGTGAACCGGGGGTTC CGACCGGGCCACA  
Pab21_230575-230517_ -__ GGGCCCGGCTCCCGCCCTCTCCGGGGAATCGTGAACCGGGGGTTC CGGCCGGGCCTACA  
Consensus GGGCCCGGUUCCCGCCUCUCCGGGGAAUCGUGAACCGGGGGUUC CGACCGGGCCACA  
#=GC SS_cons <<<<<<<<<...<<<<...<<<<.....>>>>>>>>...>>>>>>>>...  
//
```

```
# STOCKHOLM 1.0
```

```
Pab105_1335797-1335648_ -__ CCGCCCGGA-GGCCCGACCGAGGGAGCGTGCCGAGAAAAGGCGCGCATGAACGAGGCGACGTCG CCGGGCGGACA GGGCCCGGTCTCCG GGG  
Pho105_592081-592230_ +__ CCGCCCGGG-GGCCCGACCGAGGGAGCGTGCCGAGAATGGCGCGCAATGAACGAGGTGACGTCGTCGGGCGGACAGGGCCCGGTCTCCGGGG  
Pfu105_942696-942544_ -__ CCGCCCGG GCGGCCCGACCGAGGGAGCGTGCCGGCAATGGCGCGGATGAACGAGGTGACGTCCT CCGGGCGGACAGGGCCCGGCCTTCG GGG  
Consensus CCGCCCGGG-GGCCCGACCGAGGGAGCGUGCCGAGAAUAGGCGCGCAAUGAACGAGGUGACGUCG CCGGGCGGACAGGGCCCGGUCUCCGGGG  
#=GC SS_cons <<<<<<<...<<<.....>>>.<<<<<<.....>>>>>>>...<<.<<.....>>>>.>>>>>>>>...<<<<<<<<.<<<<.....
```

```
Pab105_1335797-1335648_ -__ CCGCCTGAGGTTGCCGACAACGGCGGGCAATGAGGGCGGTTGGATAAGCCGGGCCTATA--  
CCGCCTGAGGTTGCCGAGAATGGCGTTCAATGAAGGCGGGCGGATAATCCGGGCCTAAA--  
Pfu105_942696-942544_ -__ CCGCCTGAGGGAGCCGAGAAGGGCAGACGATGAAGGCGGGCGGATAAGCCGGGCCCTCAA  
Consensus CCGCCUGAGGUUGCCGAGAACGGCGGACAAUGAAGGCGGGCGGAUAAGCCGGGCCUAAA--  
#=GC SS_cons <<<<<<...<<<<.....>>>>.....>>>>>>>>.>>>>...>>>>>>>>.....  
//
```

Stockholm - Rfam

```
# STOCKHOLM 1.0
#=GF ID      snoR9
#=GF AC      RF00065
#=GF DE      Small nucleolar RNA snoR9
#=GF AU      Bateman A, Daub J
#=GF GA      50.0
#=GF NC      49.8
#=GF TC      68.7
#=GF SE      Bateman A
#=GF SS      Published; PMID:12032319
#=GF TP      Gene; snRNA; snoRNA; CD-box;
#=GF BM      cmbuild -F CM SEED; cmcalibrate --mpi -s 1 CM
#=GF BM      cmsearch -Z 274931 -E 1000000 --toponly CM SEQDB
#=GF DR      SO:0000593 SO:C_D_box_snoRNA
#=GF DR      GO:0006396 GO:RNA processing
#=GF DR      GO:0005730 GO:nucleolus
#=GF RN      [1]
#=GF RM      12032319
#=GF RT      Noncoding RNA genes identified in AT-rich hyperthermophiles.
#=GF RA      Klein RJ, Misulovin Z, Eddy SR;
#=GF RL      Proc Natl Acad Sci U S A 2002;99:7542-7547.
#=GF CC      snoRNA R9 is a member of the C/D class of snoRNA which contain
#=GF CC      the C (UGAUGA) and D (CUGA) box motifs. R9 was identified in a
#=GF CC      computational screen in AT-rich hyperthermophiles [1]. R9 was
#=GF CC      found to overlap with the smaller snoRNA R19 which is currently a
#=GF CC      member of Pyrococcus C/D box snoRNA family Rfam:RF00095.
#=GF WK      http://en.wikipedia.org/wiki/Small_nucleolar_RNA_snoR9
#=GF SQ      5

#=GS Pyrococcus_furiosus AC AE009950.1/163991-163864
#=GS Pyrococcus_abyssi_GE AC AJ248283.1/230575-230449
#=GS Pyrococcus_horikoshi AC BA000001.2/215834-215709
#=GS P.furiosus AC AF468960.1/1-128
#=GS Thermococcus_kodakar AC AP006878.1/47908-47779
```

Stockholm

Stockholm - Rfam

```
#=GS Pyrococcus_furiosus AC AE009950.1/163991-163864  
#=GS Pyrococcus_abyssi_GE AC AJ248283.1/230575-230449  
#=GS Pyrococcus_horikoshi AC BA000001.2/215834-215709  
#=GS P.furiosus AC AF468960.1/1-128  
#=GS Thermococcus_kodakar AC AP006878.1/47908-47779
```

```
Pyrococcus_furiosus  
Pyrococcus_abyssi_GE  
Pyrococcus_horikoshi  
P.furiosus  
Thermococcus_kodakar  
#=GC SS_cons  
#=GC RF
```

```
GGGCCCGGUU.CCCGCCUCUCCGGGGAAUCGUGAACCGGGGGUUCGGAC  
GGGCCCGGCU.CCCGCCUCUCCGGGGAAUCGUGAACCGGGGGUUCGGC  
CGGCCCGGUU.CCCGCCUCUCCGGGGAAUCGUGAACCGGGGGUUCGGAC  
GGGCCCGGUU.CCCGCCUCUCCGGGGAAUCGUGAACCGGGGGUUCGGAC  
GGGCCUGGCGUCCGCCUCUCCGGGGAAUCGUGAACCGGGGGUUCGGC  
<<<<<<<<.....<.<<<<<<<<.....>>>>>>>>>.....>>  
gGGCCCGGcu.CCCgCCCUCUCCGGGGAAUCGUGAACCGGGGGuUCCggC
```

```
Pyrococcus_furiosus  
Pyrococcus_abyssi_GE  
Pyrococcus_horikoshi  
P.furiosus  
Thermococcus_kodakar  
#=GC SS_cons  
#=GC RF
```

```
CGGGCCACA..AUGGGAUGAUGACCUUUUGCUUUACUGAACACAUGAUG  
CGGGCCUACA..G..UUAUGAUGAACUUUUUGCUUUUCUGAUGUGGUGAUG  
CGGGCCGACA..GG.GGAUGAAGAGCUUUUGCUUUUCUGAGCAGAUGAUG  
CGGGCCACA..AUGGGAUGAUGACCUUUUGCUUUACUGAACACAUGAUG  
CAGGCCUACACCGGGGGAUGAAGAGCUUUUGCUUUUCUGAC..UGUGAUG  
>>>>>>>.....  
CGGGCCcACA..auguuAUGAUGAaCUUUUGCUUUaCUGAagagaUGAUG
```

```
Pyrococcus_furiosus  
Pyrococcus_abyssi_GE  
Pyrococcus_horikoshi  
P.furiosus  
Thermococcus_kodakar  
#=GC SS_cons  
#=GC RF
```

```
ACCACGCCCUCGCUGAC.CUAAAUUUUGAC  
AGCACGCCCUCGCUGAUACUCUCGUCCAU  
ACCACGCCCUCGCUGAC.CU.GCUAUUUUGAC  
ACCACGCCCUCGCUGAC.CUAAAUUUUGAC  
AGCACGCCCUCACUGACCCCGUAUCAGCUCU  
.....  
AgCACGCCCUCGCUGAu.CUaaaUauUugAu
```

//

Stockholm - R2R

RF00065_seed

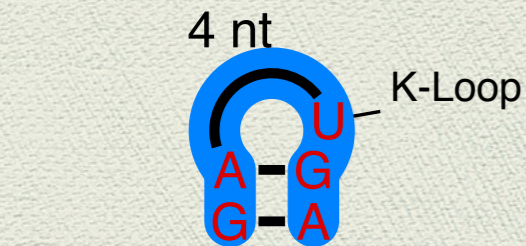

- connector (zero length)
- variable-length region
- C variable-length loop
- ≡ variable-length stem
- modular sub-structure

- base pair annotations
- covarying mutations
 - compatible mutations
 - no mutations observed



nucleotide present		nucleotide identity	
● 97%	● 75%	N	97%
● 90%	○ 50%	N	90%
		N	75%



Stockholm

RF00065_seed Pyrococcus_abyssi_GERF00065_seed Pyrococcus_furiosus

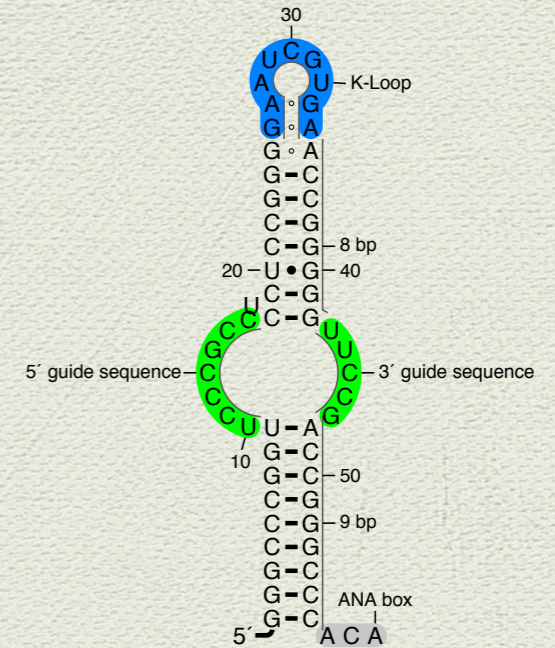
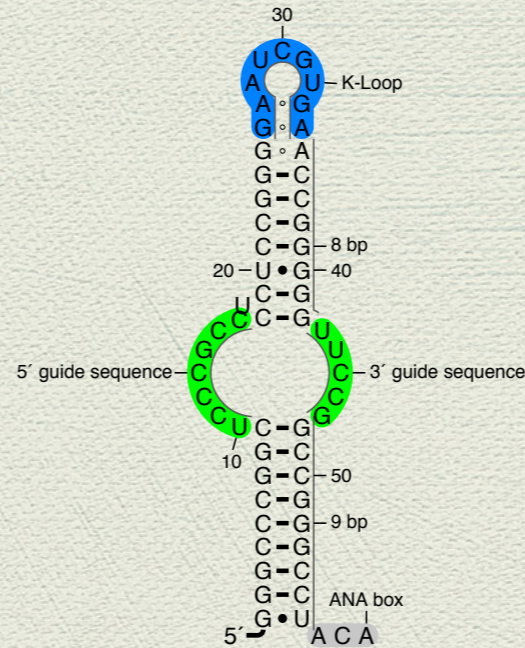

RF00065_seed Pyrococcus_horikoshiRF00065_seed Thermococcus_kodakar

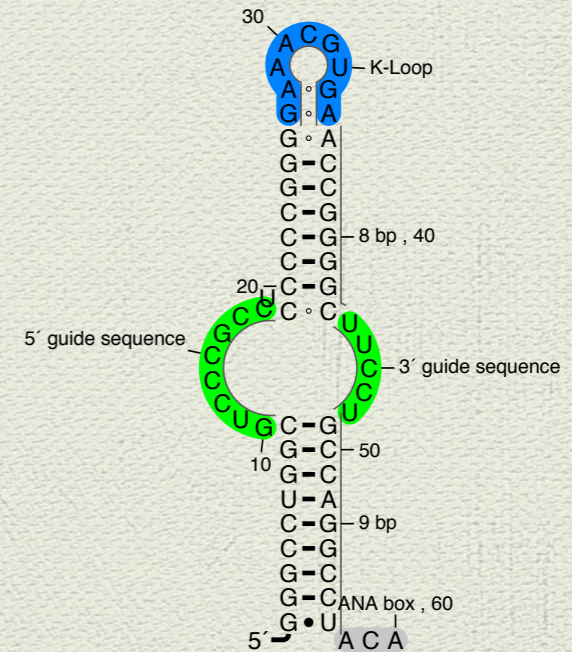
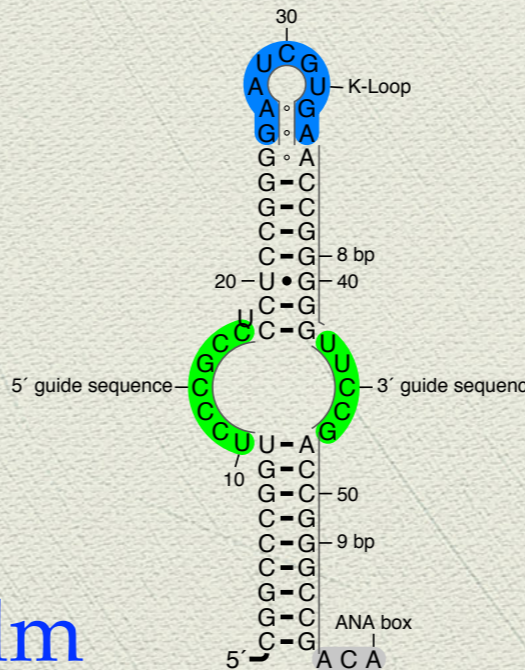

Stockholm - R2R

RF00065_seed

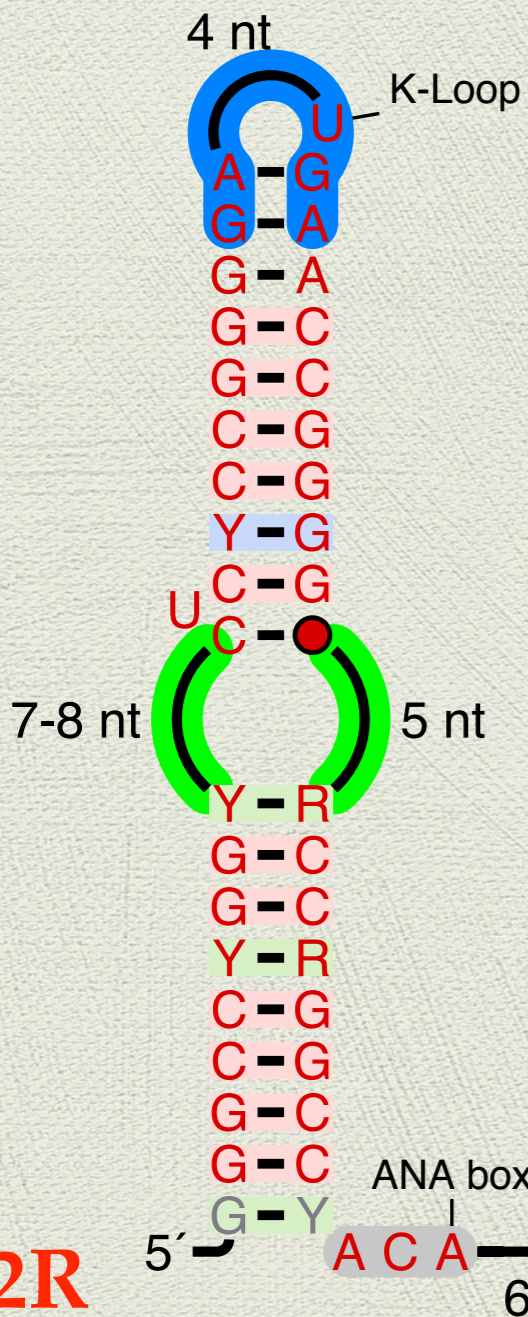

RF00065_seed skeleton-with-bp

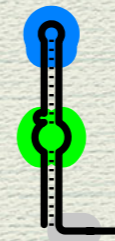

RF00065_seed-ILOOP75
subfam_weight=0.696064

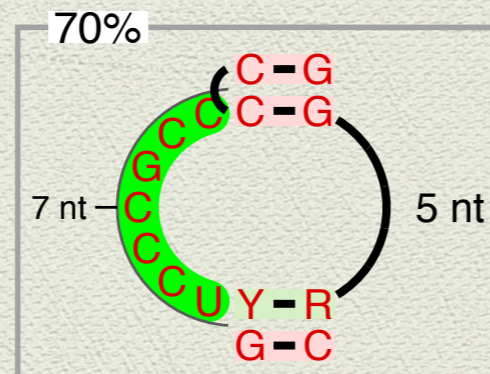

RF00065_seed-ILOOP85
subfam_weight=0.303936

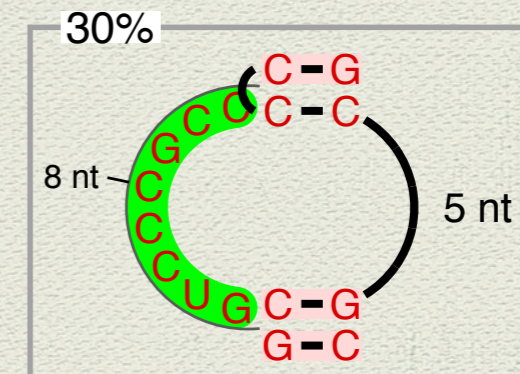

Pseudo-nœuds (pseudoknots)

- ◆ Définition: structure 2D d'acide nucléique contenant au moins 2 tige-boucle dans laquelle la moitié de l'une est intercalée entre les 2 autres moitiés de l'autre

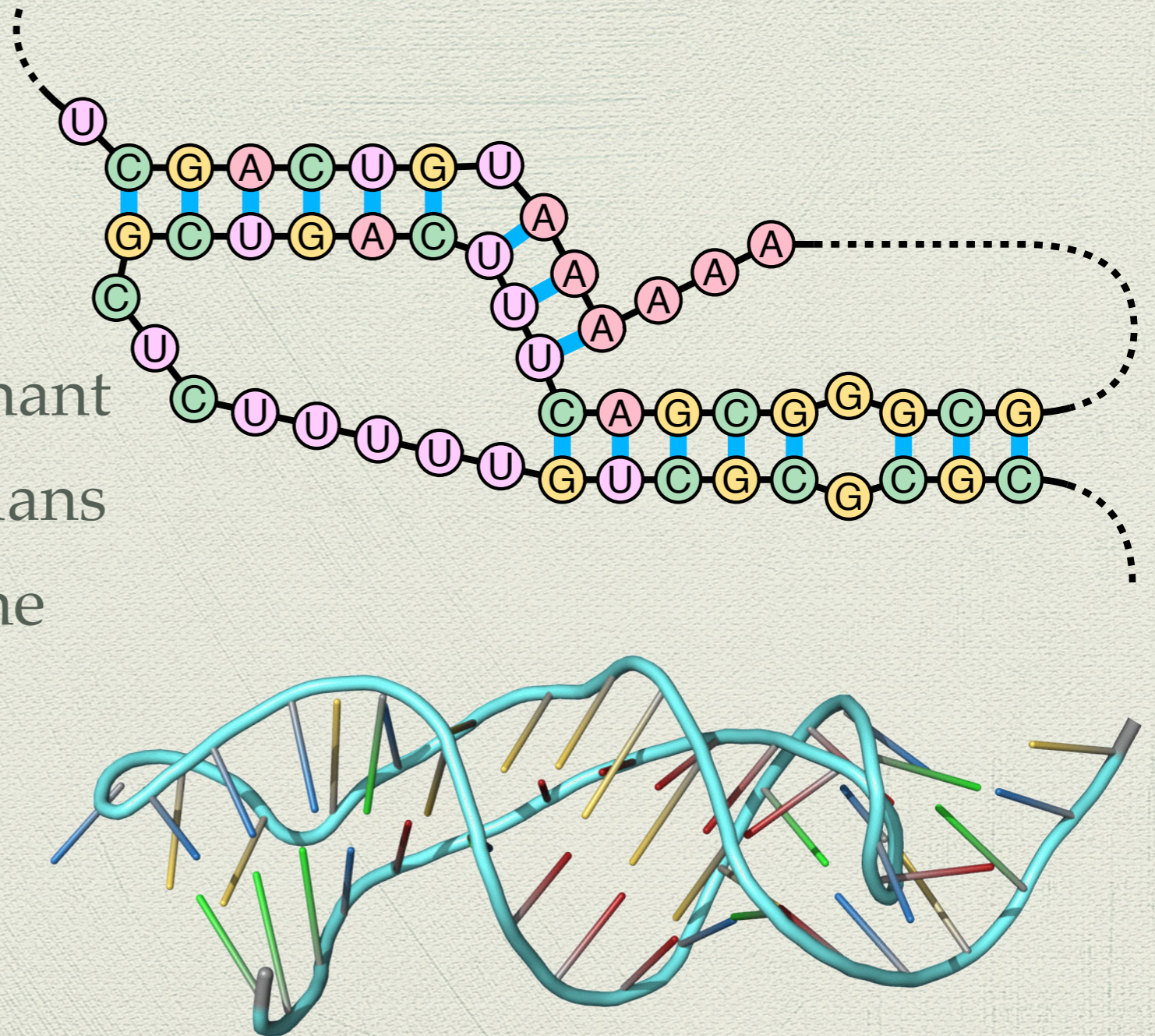

Pseudobase-Pseudoviewer

	1590	1600	1610	1620	1630
#	123456789	123456789	123456789	123456789	123456
\$	1590	AAAAAACUAAUAGAGGGGGGACUUAGCGCCCCCAAACCGUAACCCC=1636			
%	1590	::::::::::::: [[[[[[::::((([)])])::::)))::::::			

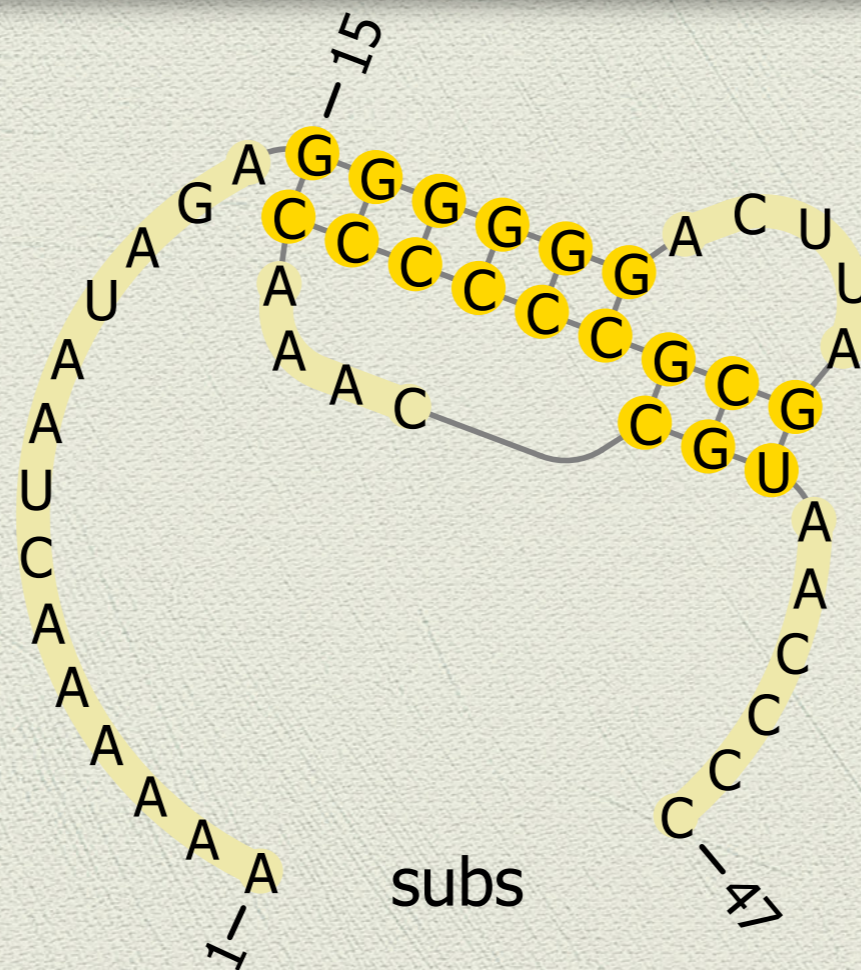

PseudoViewer

Pseudobase

Représentations circulaires

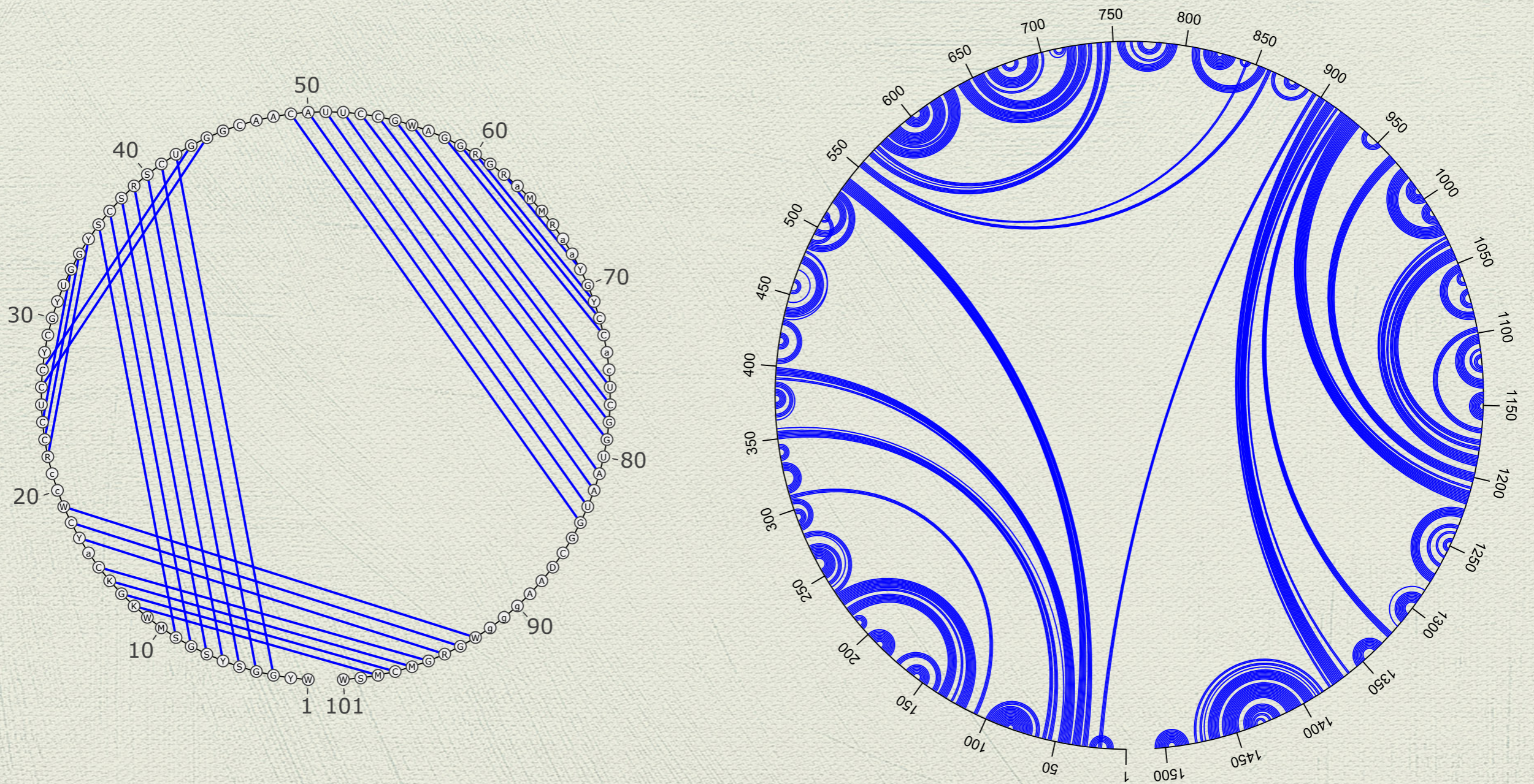

VARNA

Vienna / DBN; Connect

jViz.RNA

Ribozyme HDV (RF00059)

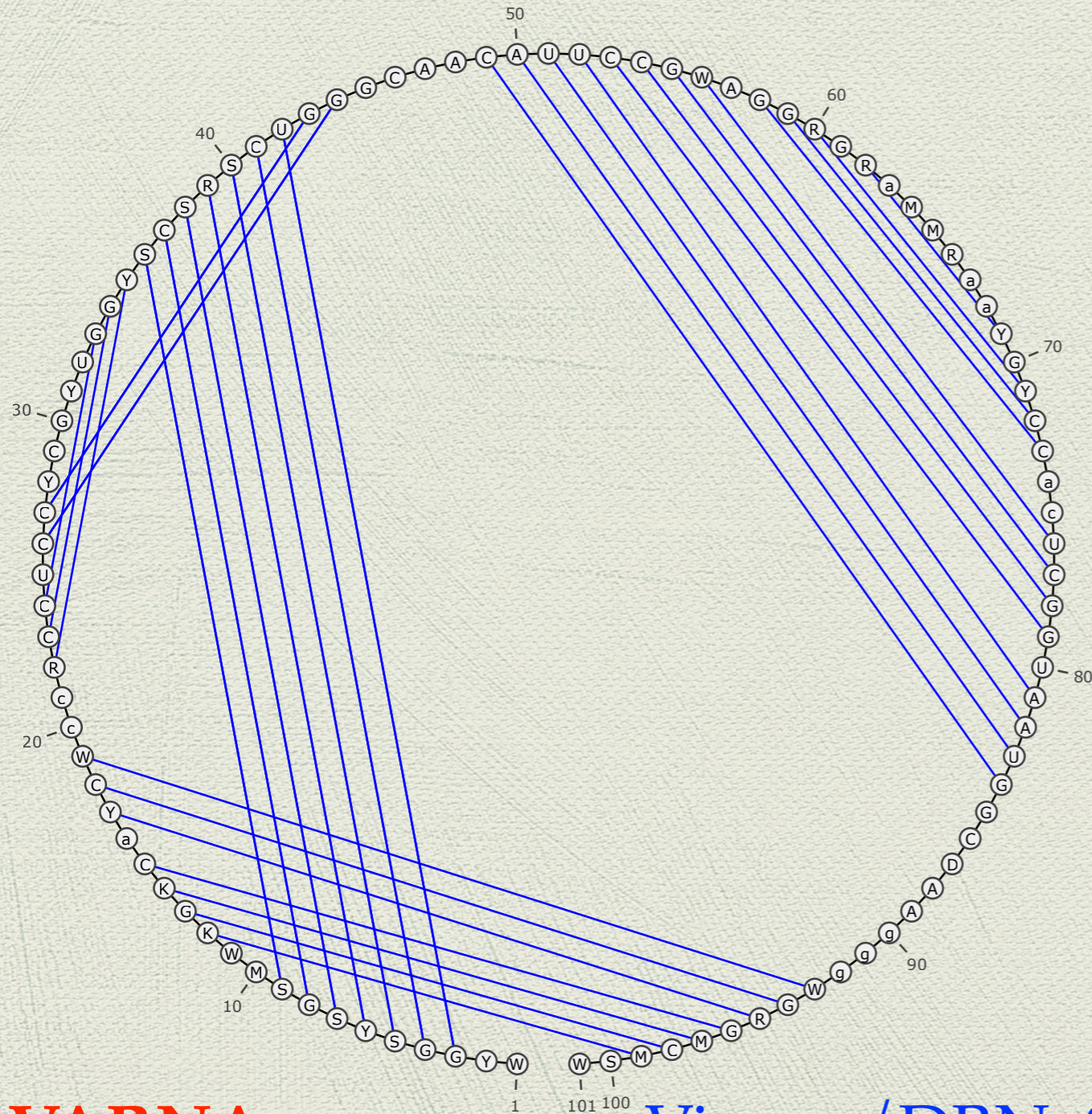

RF00059_seed

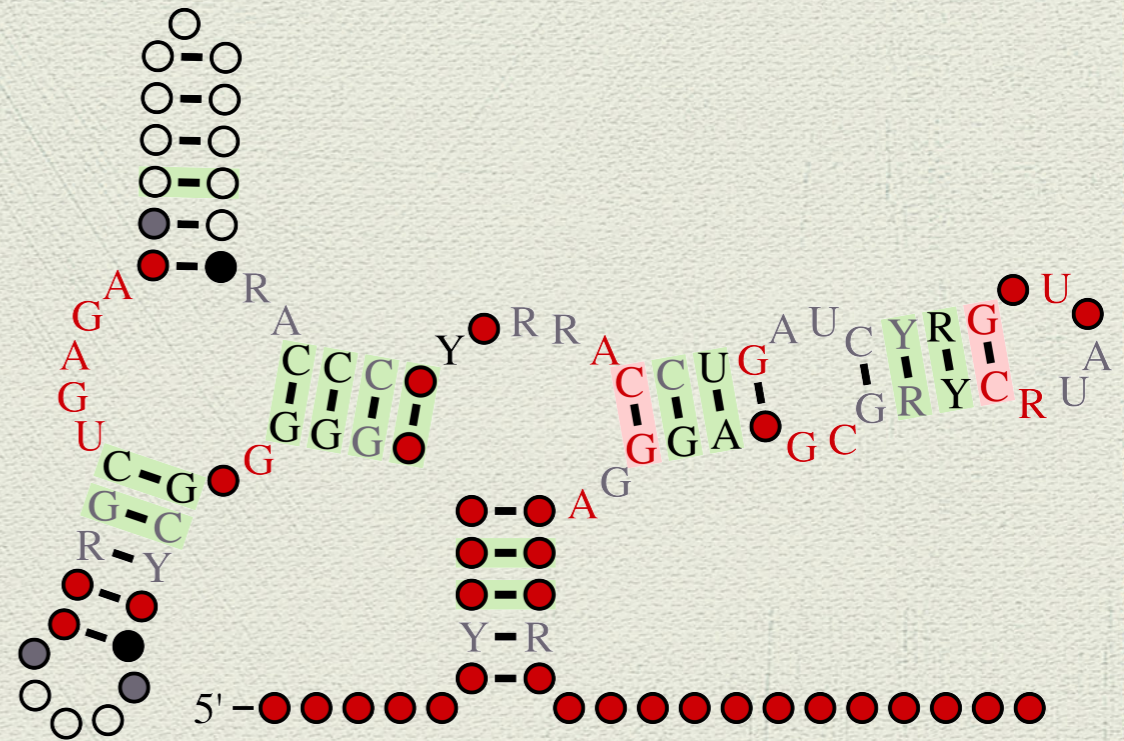

VARNAs

Vienna/DBN; Stockholm

R2R

ARNr 16S (T. thermophilus)

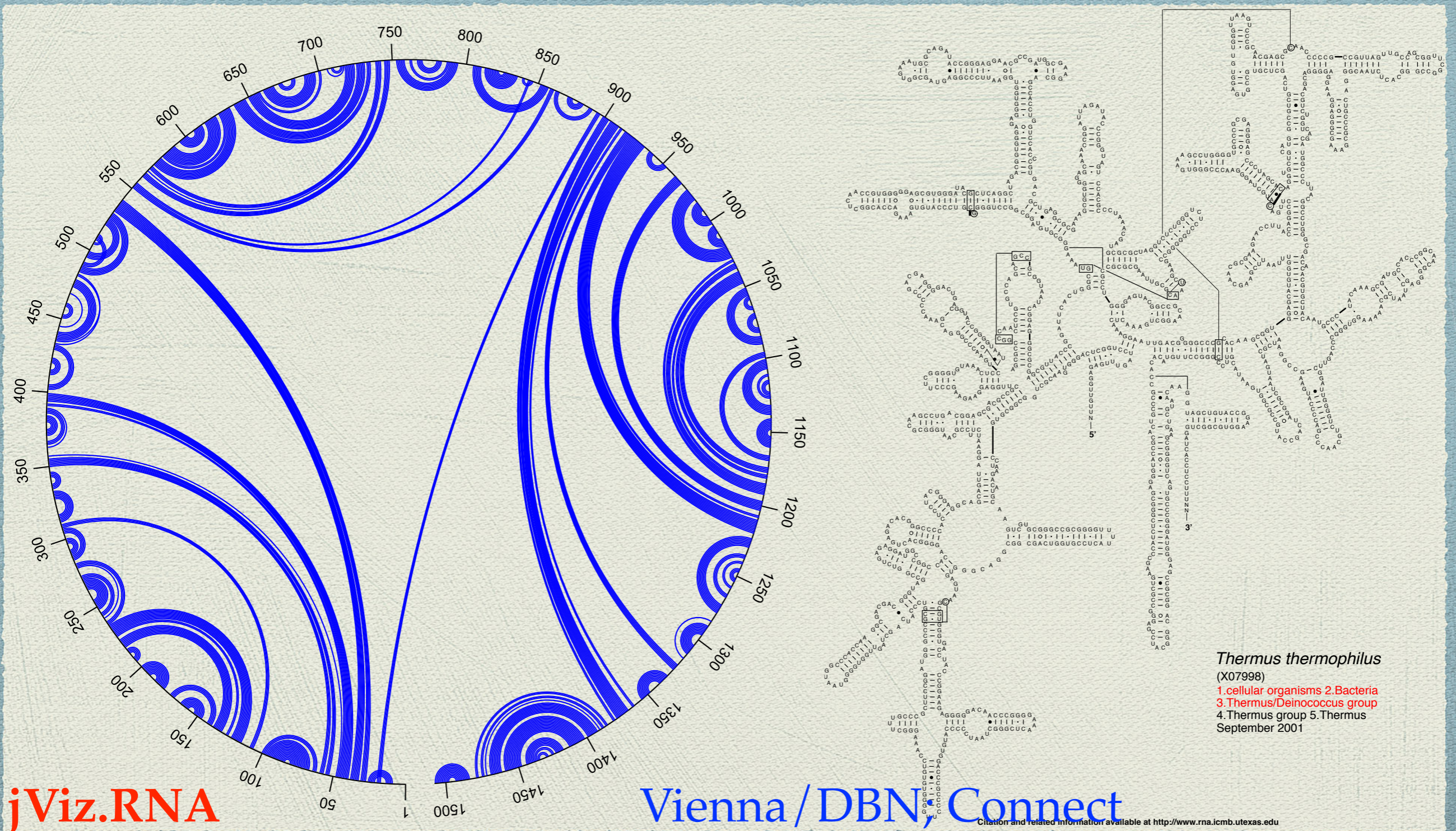

Structures 2D alternatives

conformation 1 (ON)

RIBOSWITCH

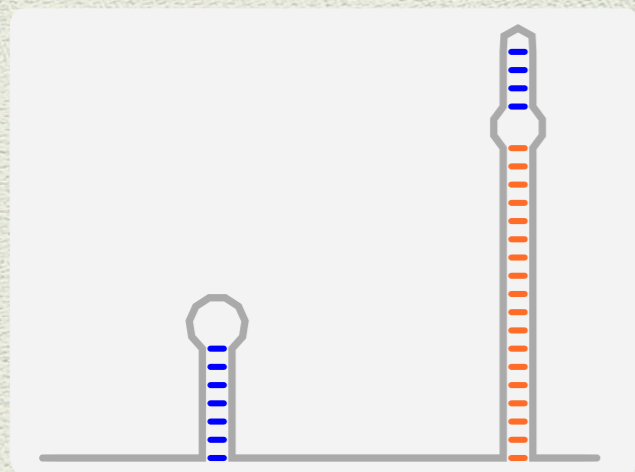

graph

Arc

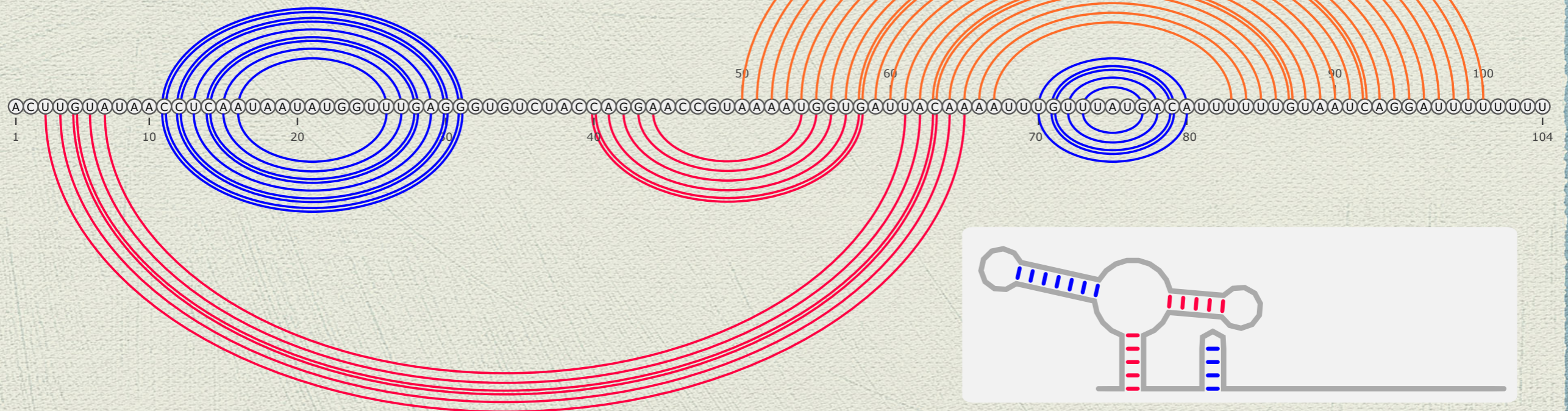

VARNA

Vienna/DBN

conformation 2 (OFF)

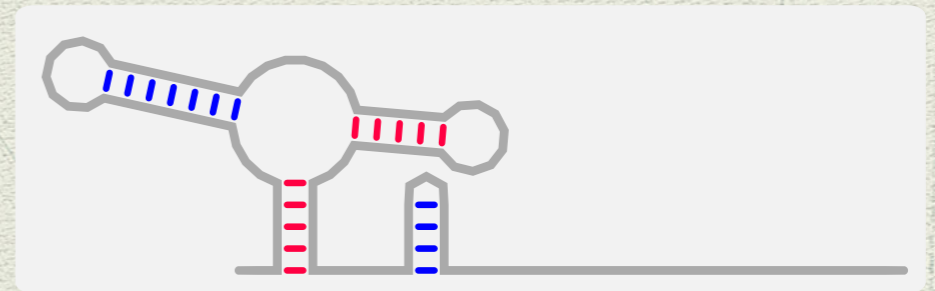

Probabilité de structures 2D

mutations, données d'accessibilité

with chemical mapping data

base pairing 1



HIV 5' UTR

RNAbows

Aalberts & Jannen, RNA, 2013

Pseudo-nœuds

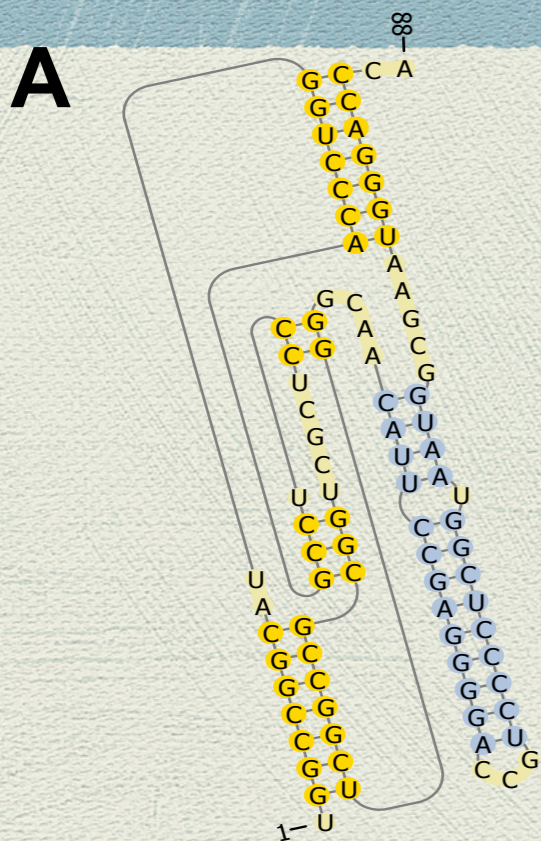

PseudoViewer

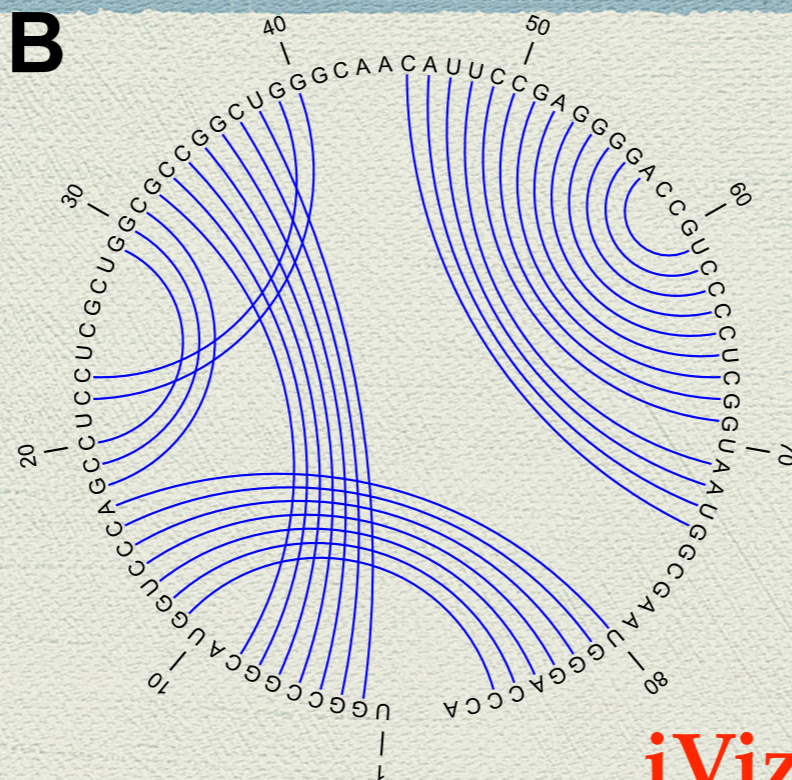

jViz.RNA

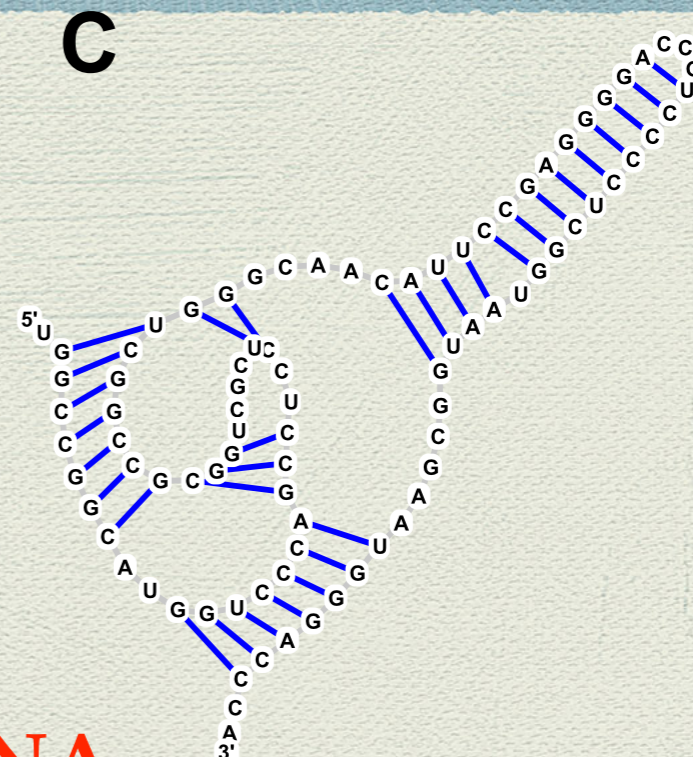

D

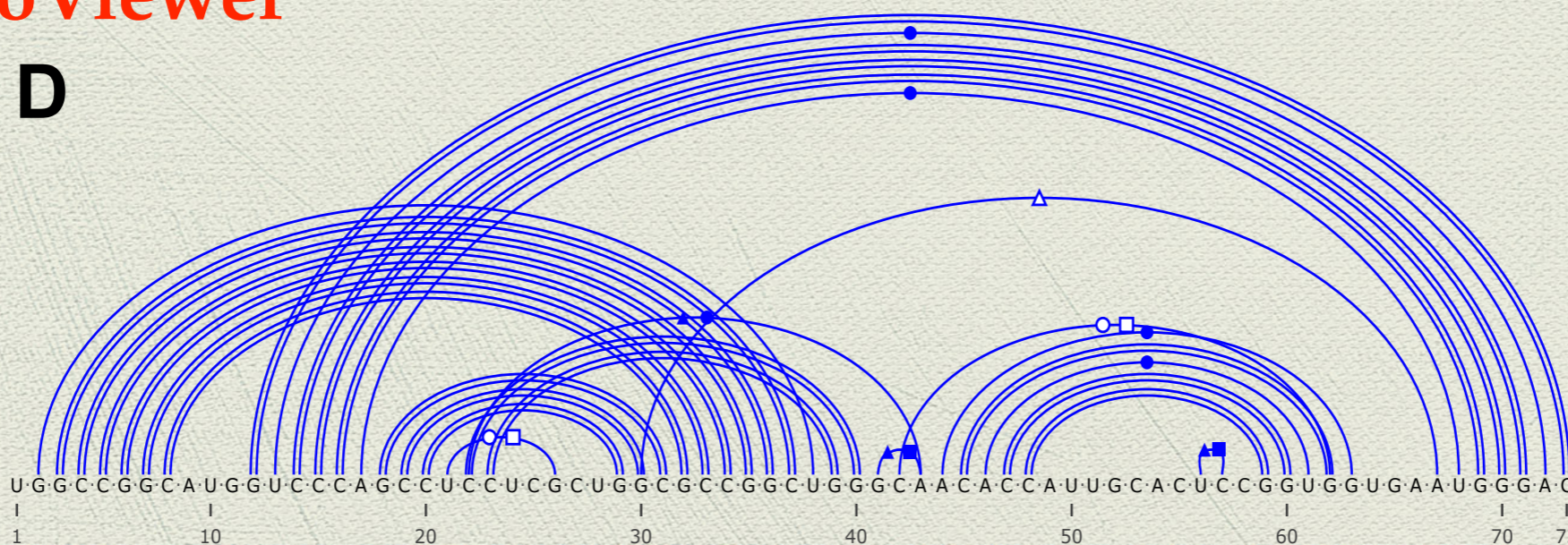

VARNA

Appariements & nomenclature

No.	Glycosidic bond orientation	Interacting edges		Abbreviation	Symbol	Triangle abstraction
		NT1	NT2			
1	<i>Cis</i>	Watson–crick	Watson–crick	cWW		
2	<i>Trans</i>	Watson–crick	Watson–crick	tWW		
3	<i>Cis</i>	Watson–crick	Hoogsteen	cWH		
		Hoogsteen	Watson–crick	cHW		
4	<i>Trans</i>	Watson–crick	Hoogsteen	tWH		
		Hoogsteen	Watson–crick	tHW		
5	<i>Cis</i>	Watson–crick	Sugar edge	cWS		
		Sugar edge	Watson–crick	cSW		
6	<i>Trans</i>	Watson–crick	Sugar edge	tWS		
		Sugar edge	Watson–crick	tSW		
7	<i>Cis</i>	Hoogsteen	Hoogsteen	cHH		
8	<i>Trans</i>	Hoogsteen	Hoogsteen	tHH		
9	<i>Cis</i>	Hoogsteen	Sugar edge	cHS		
		Sugar edge	Hoogsteen	cSH		
10	<i>Trans</i>	Hoogsteen	Sugar edge	tHS		
		Sugar edge	Hoogsteen	tSH		
11	<i>Cis</i>	Sugar edge (priority)	Sugar edge	cSs		
		Sugar edge	Sugar edge (priority)	csS		
12	<i>Trans</i>	Sugar edge (priority)	Sugar edge	tSs		
		Sugar edge	Sugar edge (priority)	tsS		

Lentos & Westhof, *Curr. Opin. Struct. Biol.*, 2003

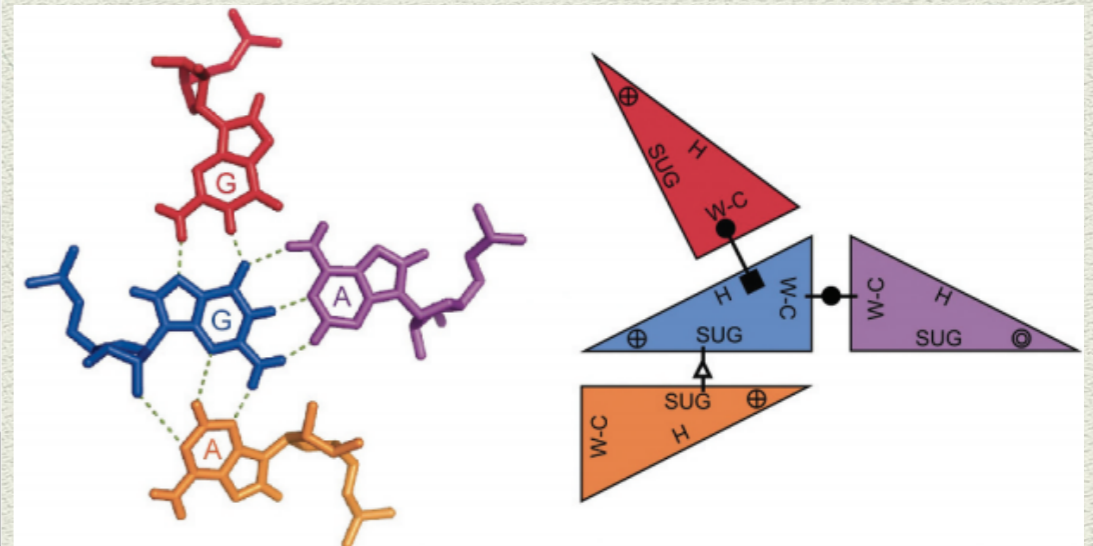

Stombaugh *et al.*, *NAR*, 2009

Motifs ARN & fonction(s)

◆ flexibilité

- ◆ nucléotide(s) non appariés, appariements non canoniques

◆ structures et “formes” 3D

- ◆ appariements canoniques / non-canoniques & sillons

◆ interactions: ARN-ARN, ARN-protéine, ARN-ligand, ...

- ◆ régions simple / double-brin, formes et contacts

Bulges: flexibility & interaction

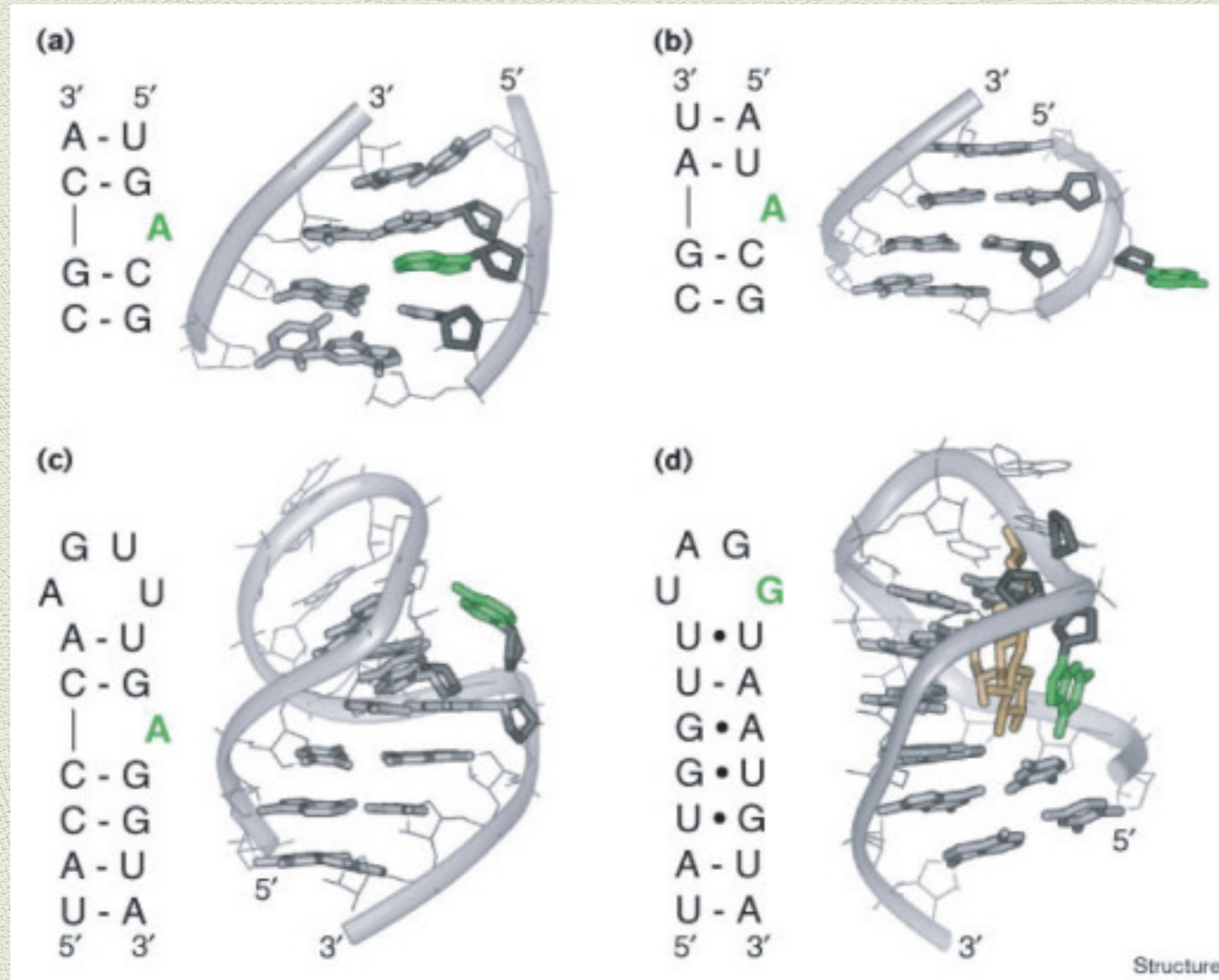

Hermann & Patel, Structure, 2000

Appariements & sillons

appariements non-canoniques et ouverture du grand sillon

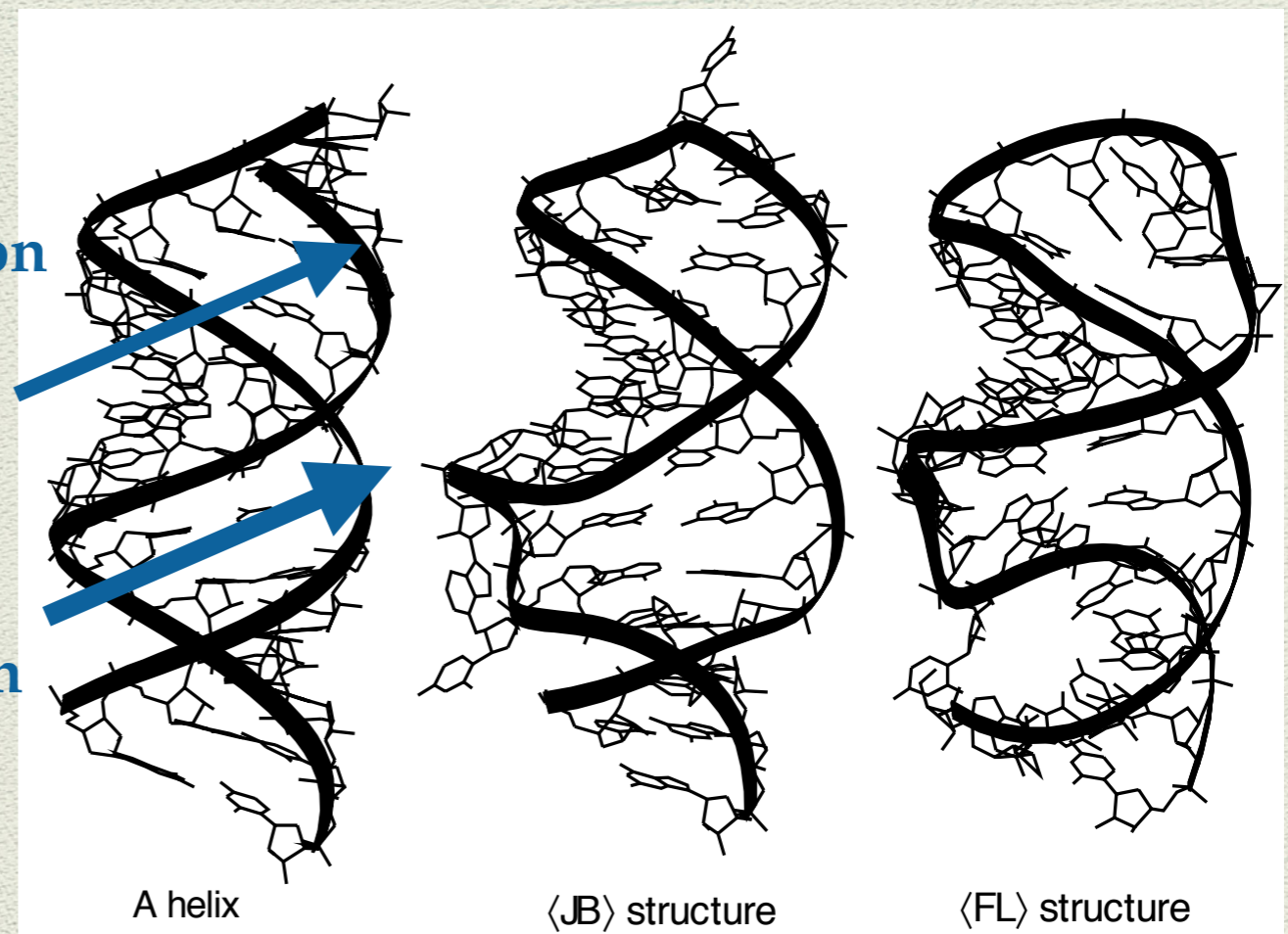
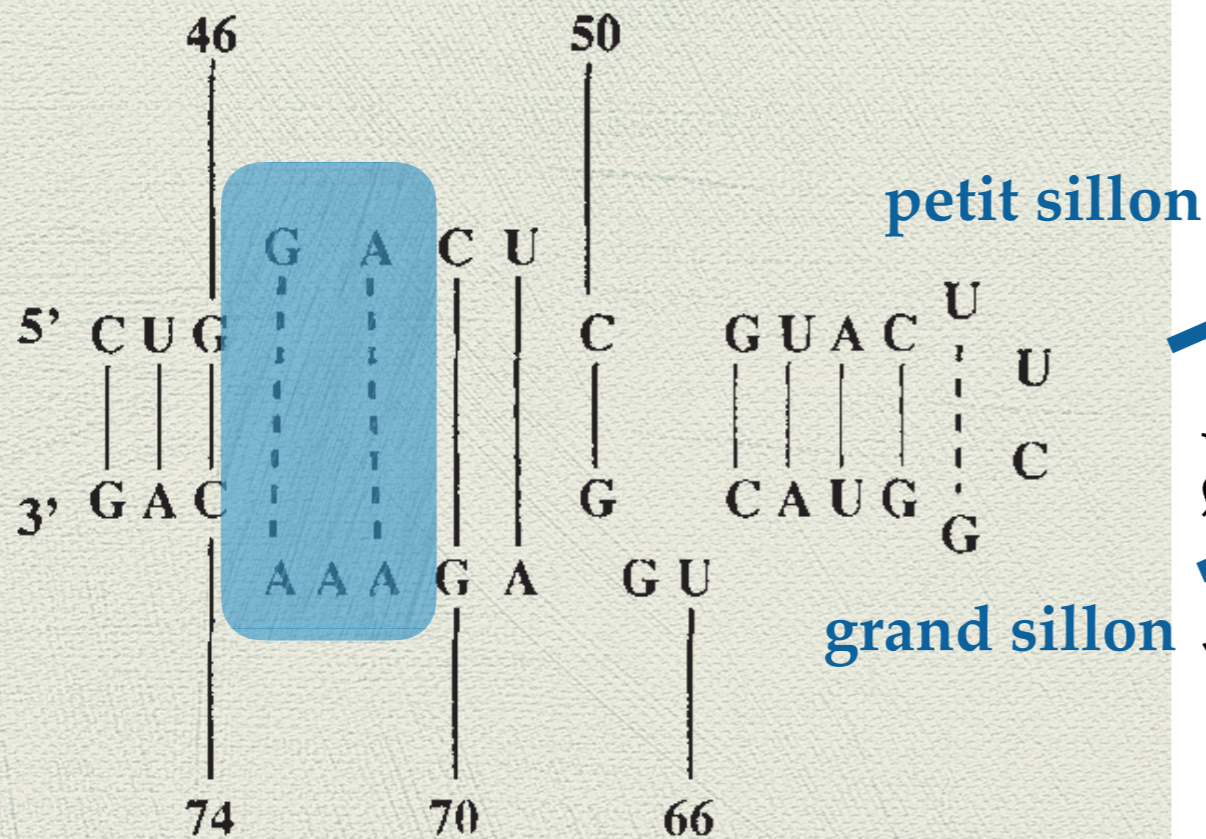

appariements NWC

ARN de liaison à la protéine Rev (VIH-1)

Leclerc *et al.*, Nat. Struct. Biol., 1994; Leclerc *et al.*, Fold. Des., 1997

Motifs récurrents

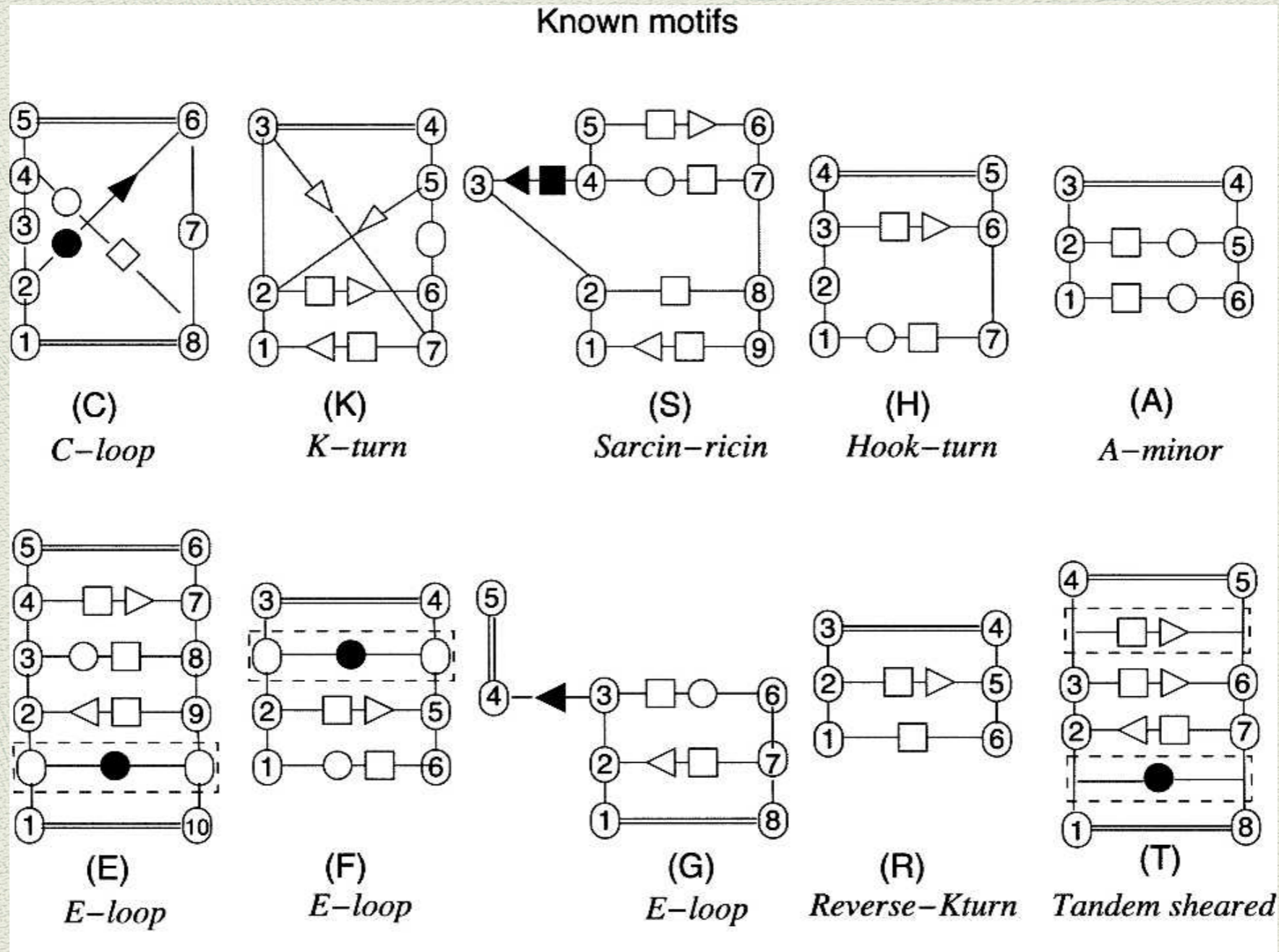

Motifs ARN 3D & “formes”

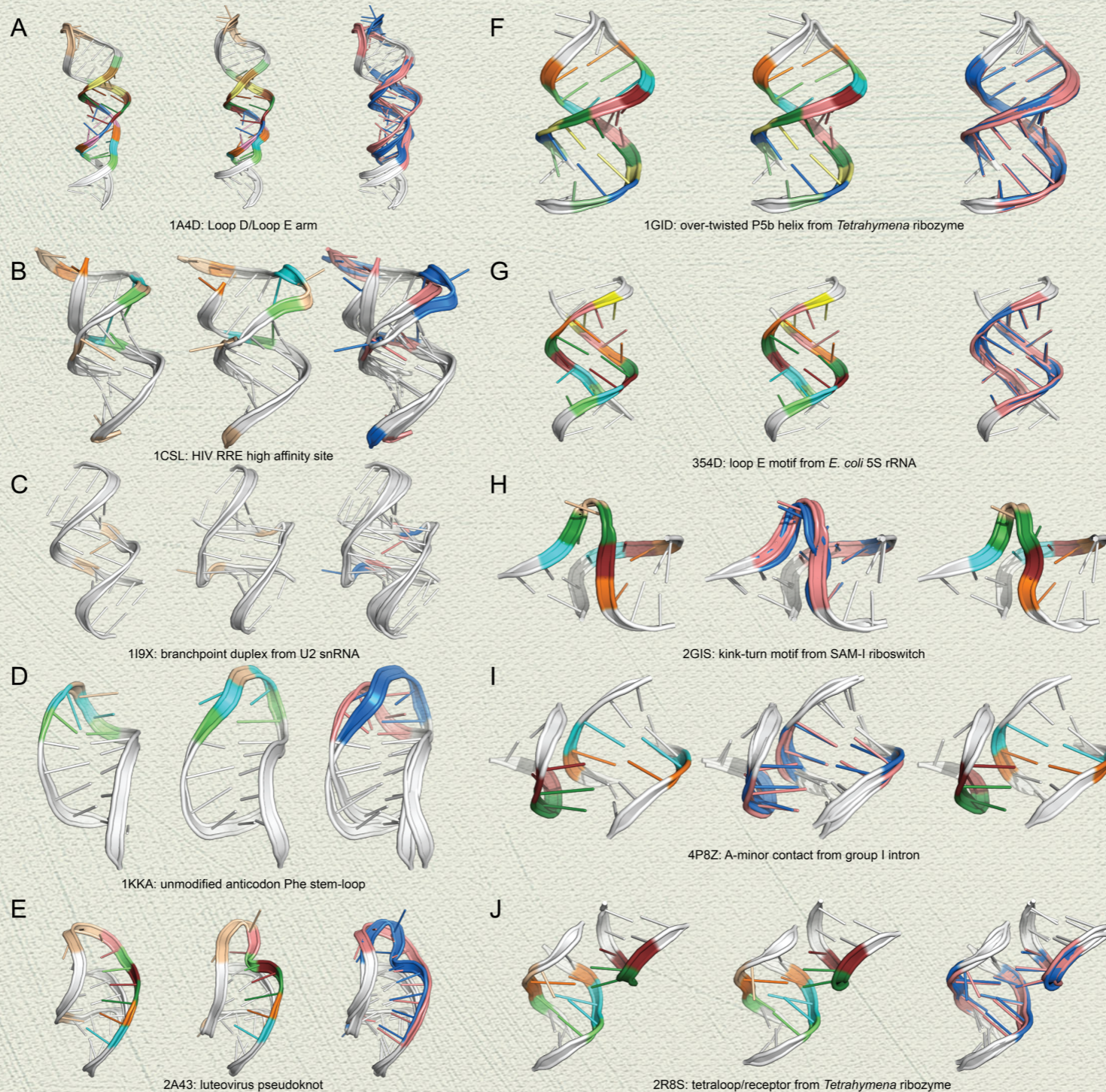

Motif Kink-turn (K-loop)

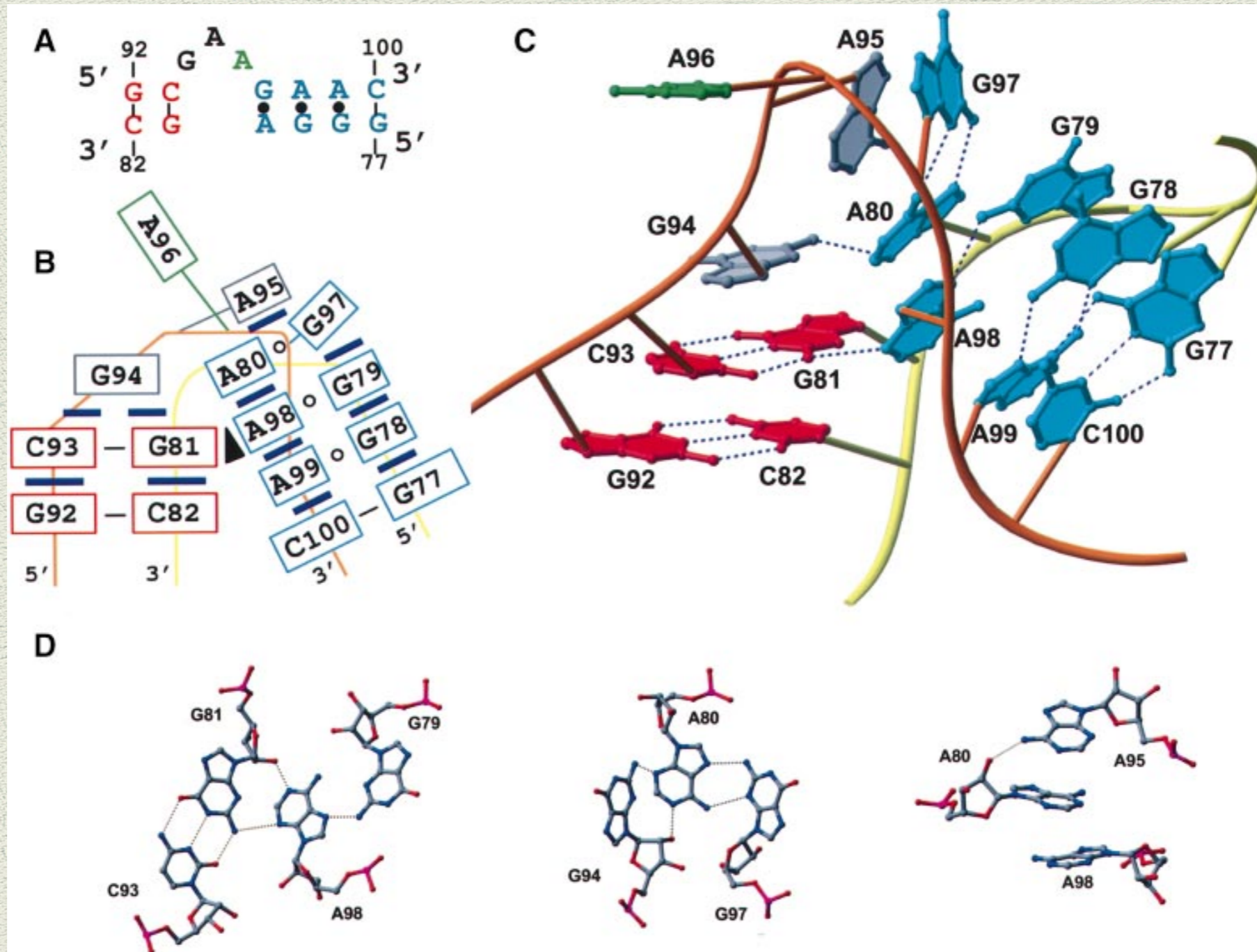

Klein *et al.*, EMBO J., 2001

ARNr 16S

16S KT-23

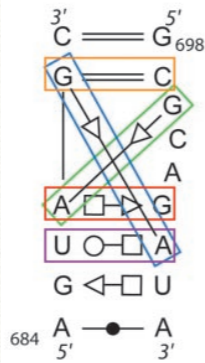

Secondary Structure: small subunit ribosomal RNA

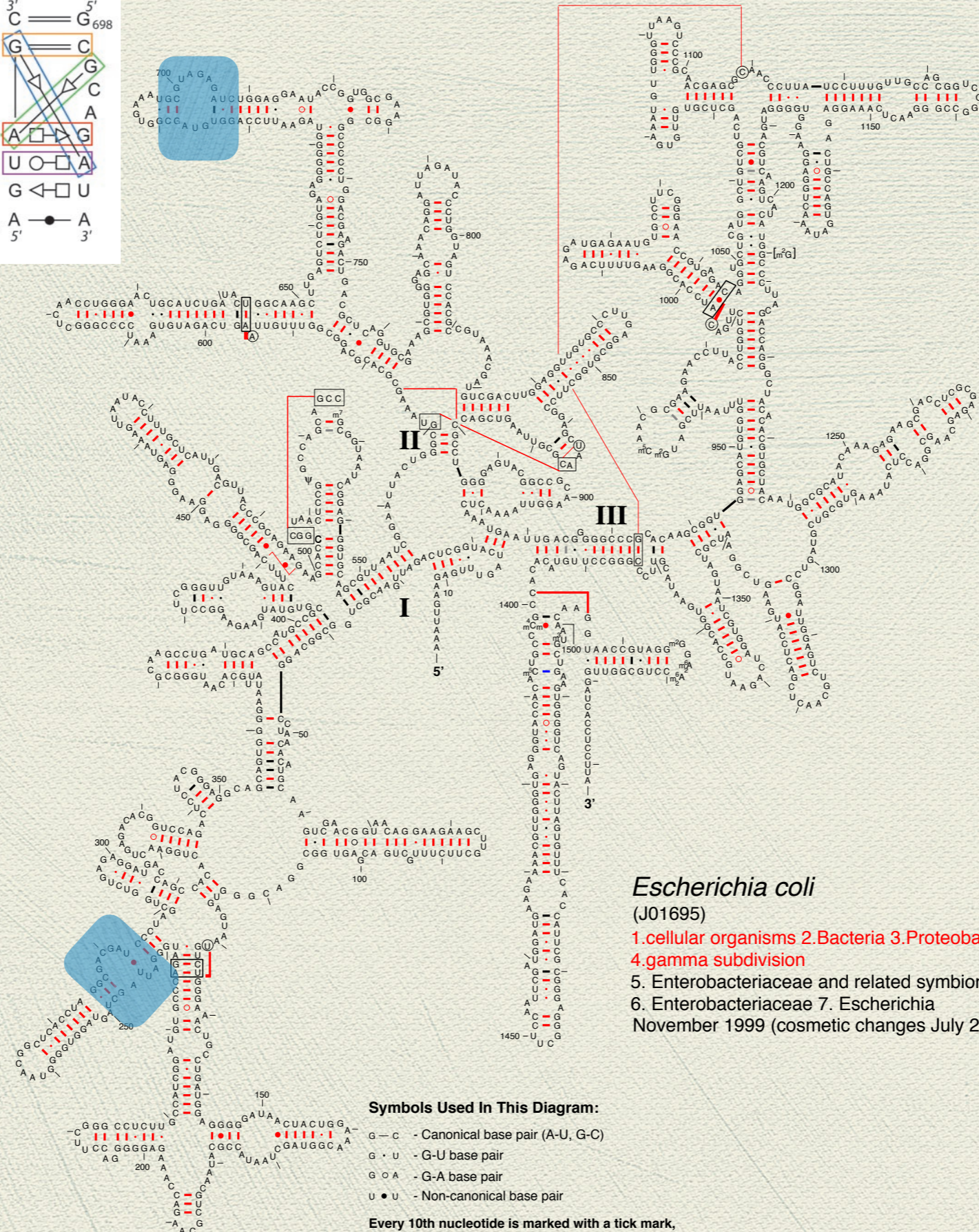

16S KT-11

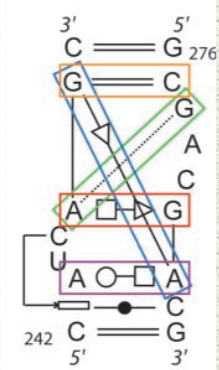

Escherichia coli

(J01695)

- 1. cellular organisms
 - 2. Bacteria
 - 3. Proteobacteria
 - 4. gamma subdivision
 - 5. Enterobacteriaceae and related symbionts
 - 6. Enterobacteriaceae
 - 7. Escherichia
- November 1999 (cosmetic changes July 2001)

Symbols Used In This Diagram:

- c — Canonical base pair (A-U, G-C)
- u · G-U base pair
- o a o G-A base pair
- u • Non-canonical base pair

Every 10th nucleotide is marked with a tick mark, and every 50th nucleotide is numbered.

Motifs 2D K-turn

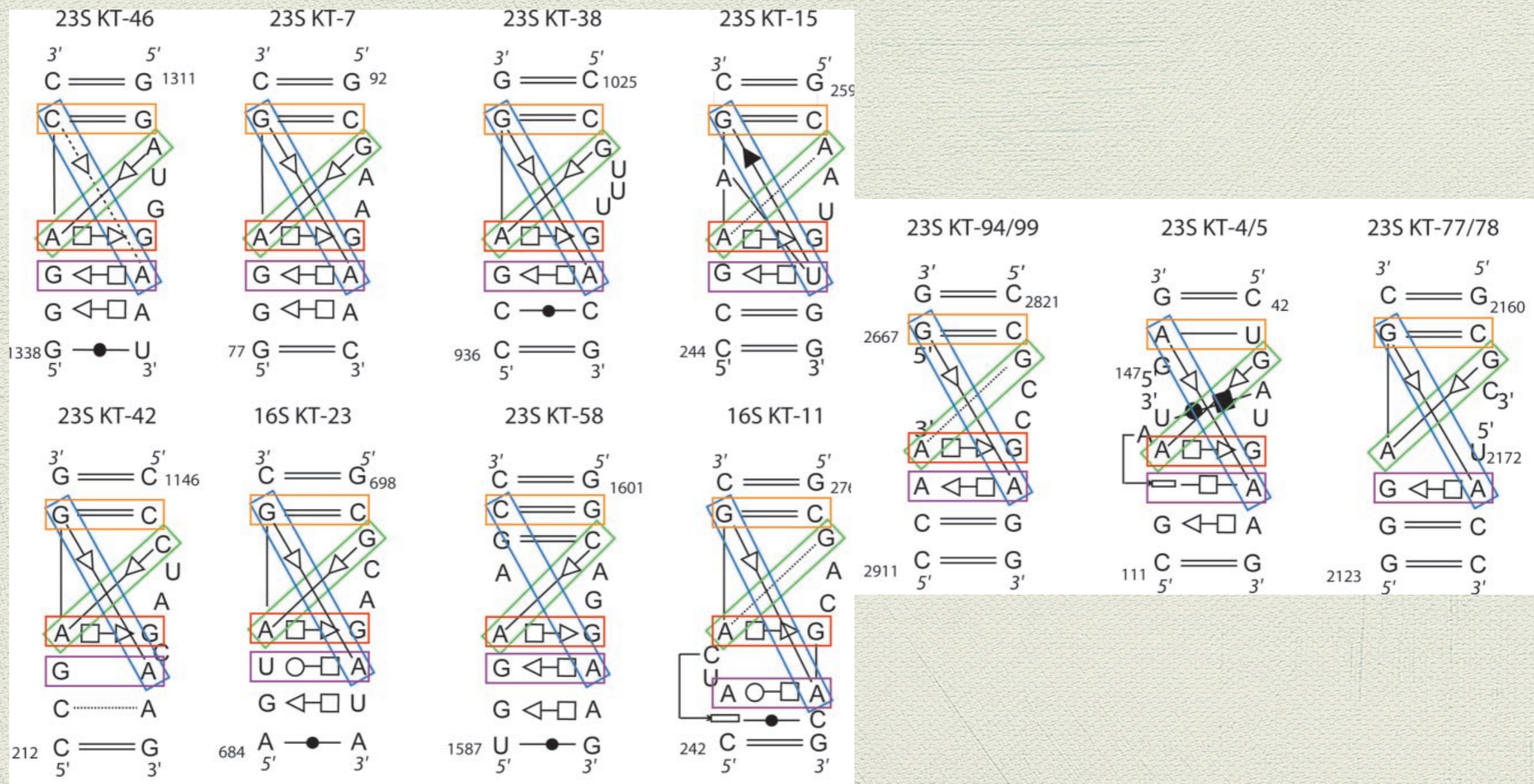

Motifs K-turn & interactions

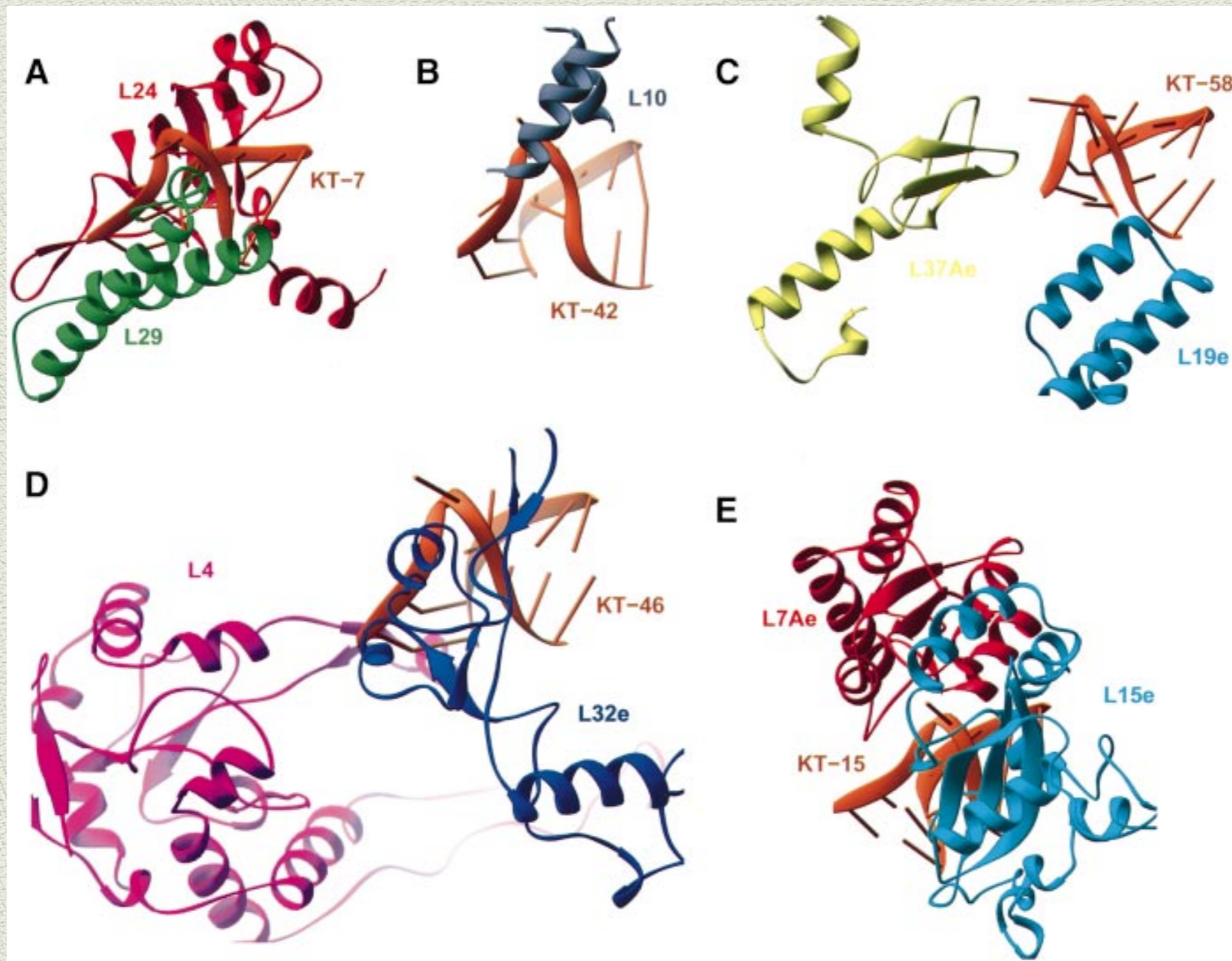

Données phylogénétiques

Stockholm; Vienna/DBN

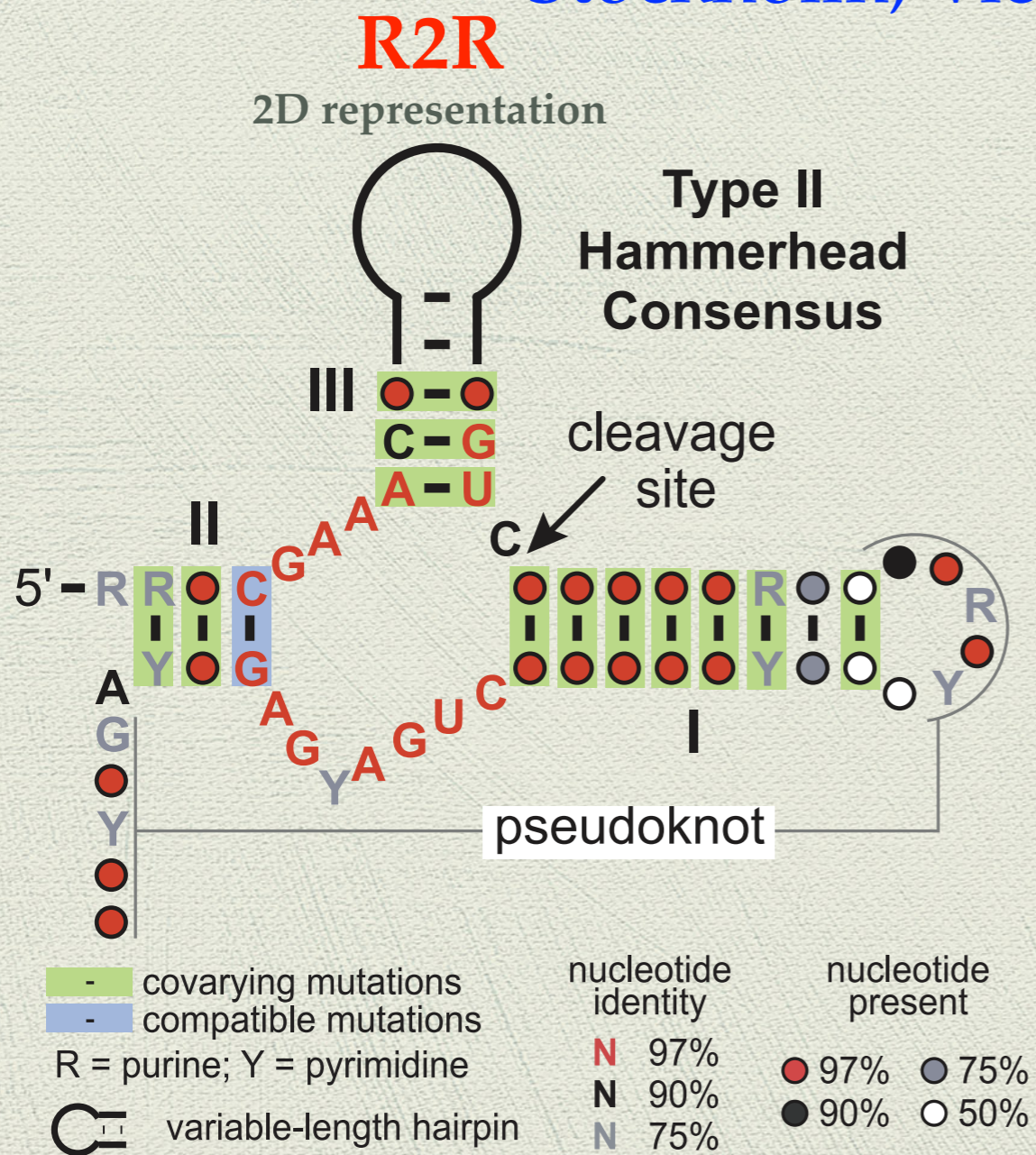

Perreault *et al.*, PLoS One, 2011

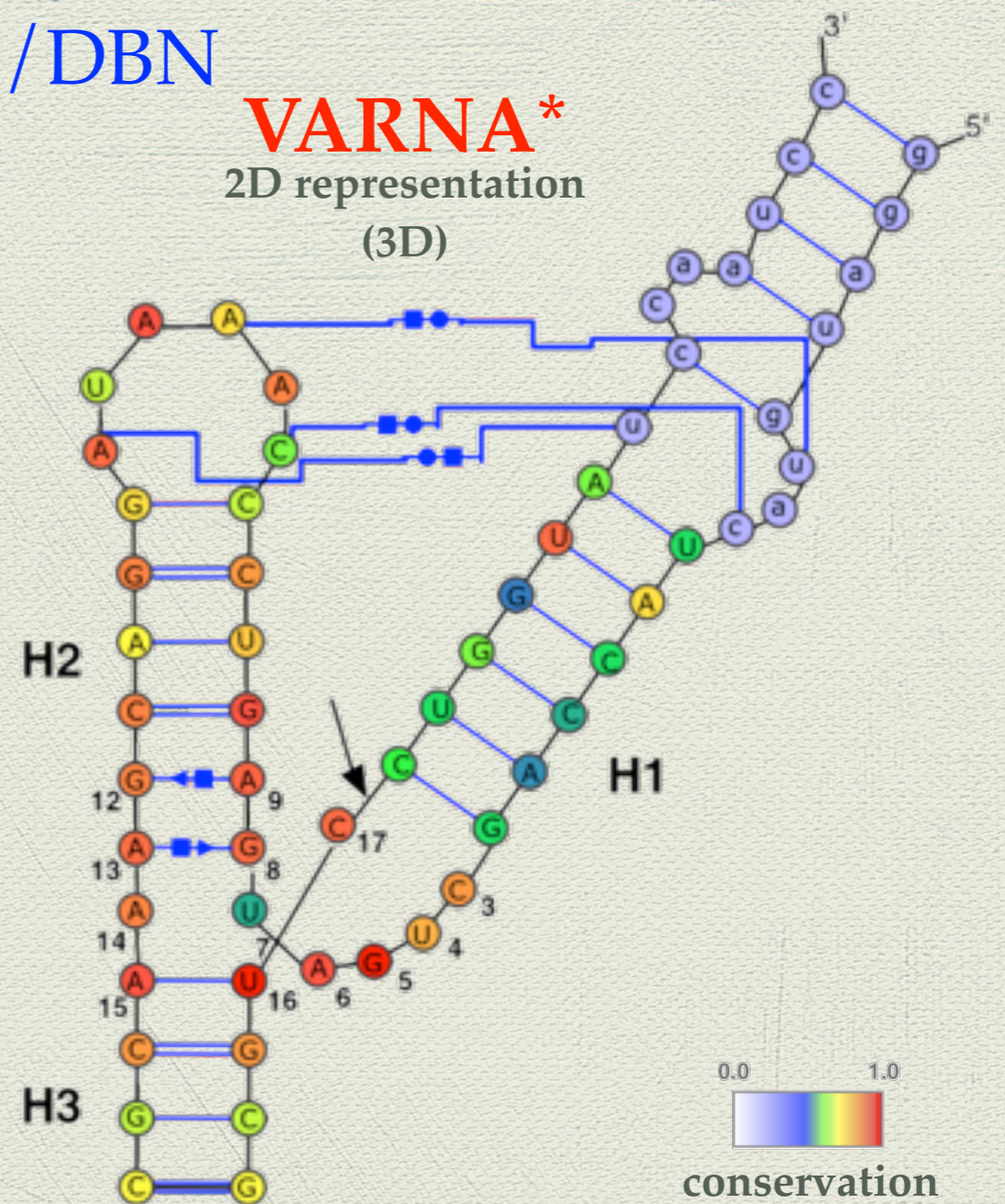

Leclerc, Molecules, 2010

* post-processing

Le ribozyme à tête de marteau

HHR

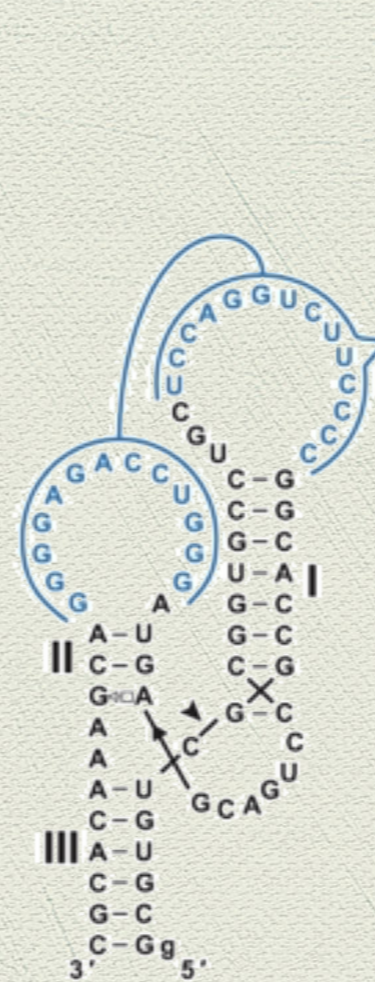
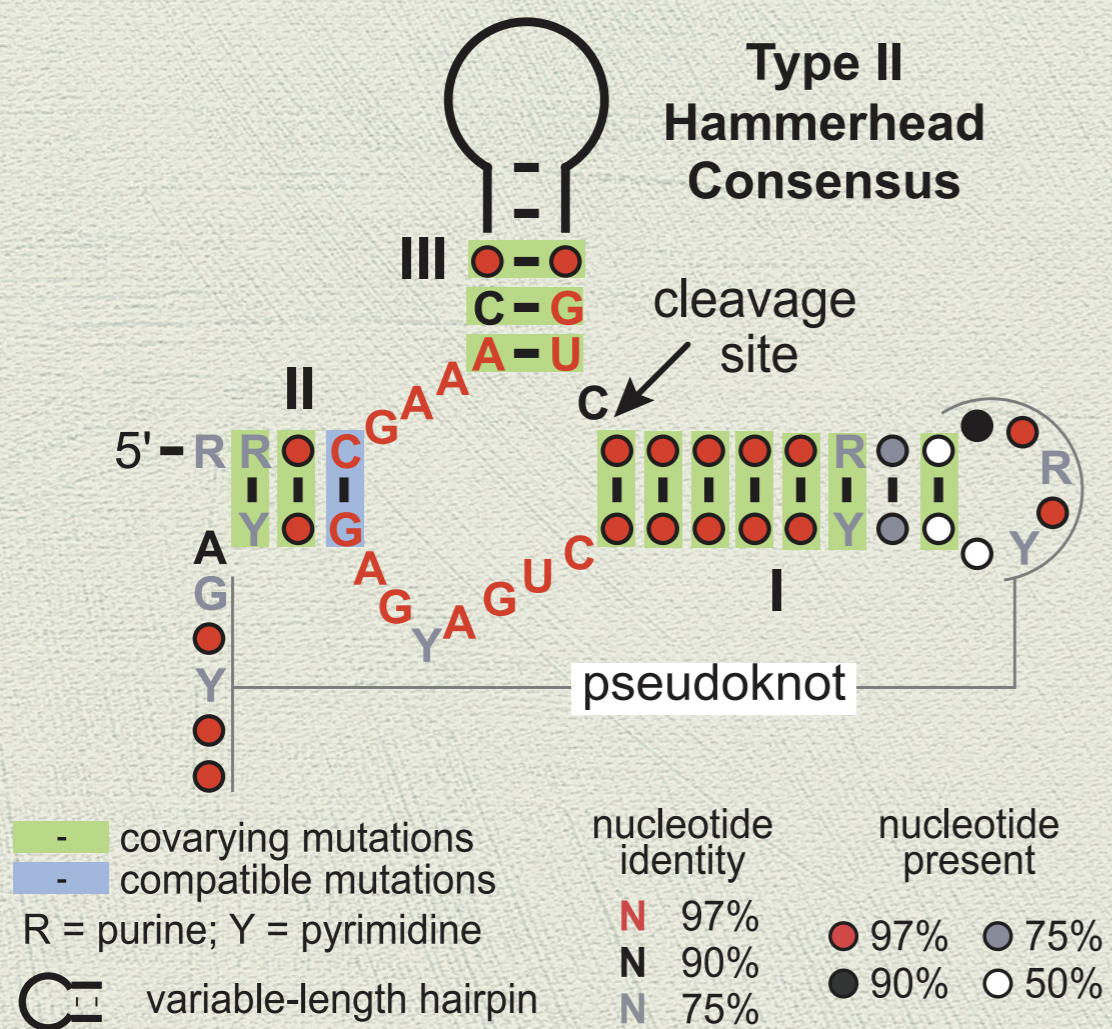

marine metagenome



Drosophila pseudoobscura

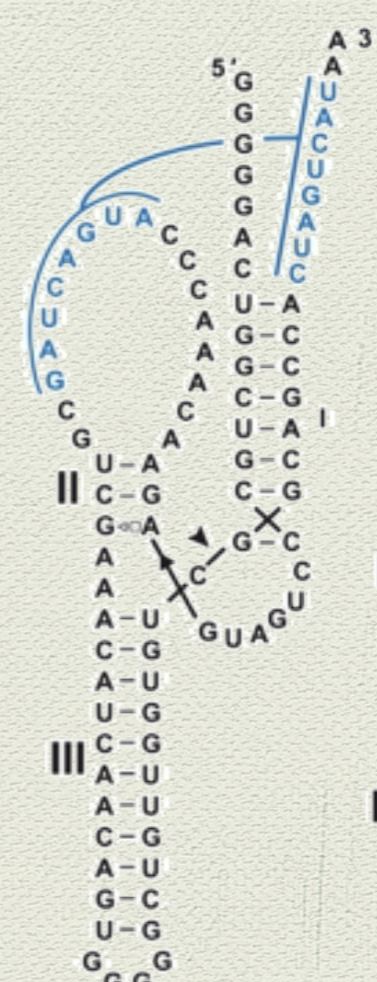

Yarrowia lipolytica

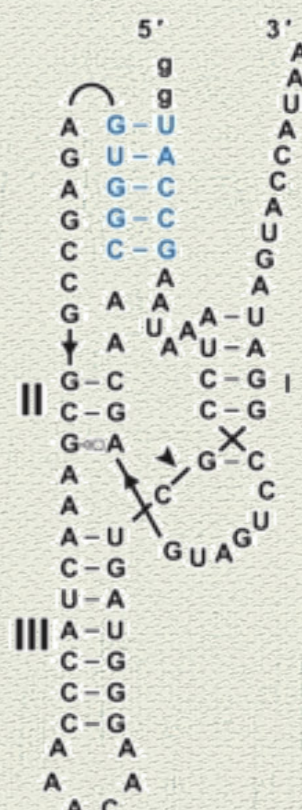

mouse gut metagenome

Diagrammes Arc

covariations, conservation

R-Chie

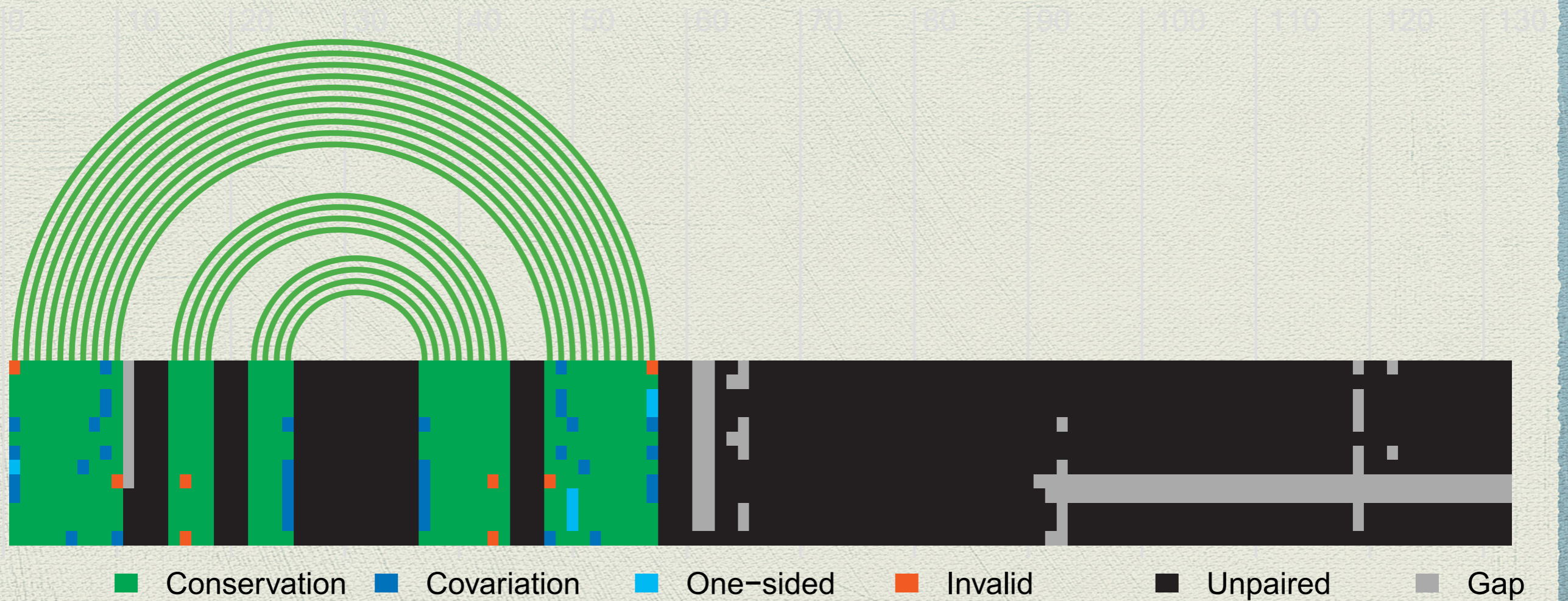

RFAM: RF00065

Stockholm

Alignments

CLUSTALW

```

interORF_Pyro_furi_347 GCATATAAGGAGT AGGCTCAGGAAGCCGTCCACTCCTCACCAATCAGGTGCGGAAGGCATCATCGCCTTACCTCCC 79
interORF_Pyro_hori_397 GCATATAAGGAGT-AGGCTCAGGAAGCCGTCCACTCCTCATCATTAGGTGCGGAAGGCTTCATCATCGCCTTCTTTACT 79
interORF_Pyro_abys_654 GCGTATAAGGAGTGAGGCTCAGGAAGCCGTCCACTCCTCACCGTTCAGGTGCGGAAGGCTTCATCATTGCCATTTATATT 80
ruler 1.....10.....20.....30.....40.....50.....60.....70.....80

```



```

** * *** ** * * * * * * * * * *
interORF_Pyro_furi_347 TTAGATTCTTATGTTTTTAATCTAATCTTGTATCTTTTTAACATTCTTACGTCAAATA 138
interORF_Pyro_hori_397 TTAT-TGTTAAAAGTTTATAAGGTAACTAATAGCATTTAAACAGCTAGAATTTGTAAA 137
interORF_Pyro_abys_654 TTCTTCATGTAAGTTTTATAAATTAACCCGATTATTTCTCAACGATGATAGTAGGCCTA 139
ruler .....90.....100.....110.....120.....130.....

```



STOCKHOLM 1.0

```

interORF_Pyro_abys_654_ GCGTATAAGGAGTGAGGCTCAGGAAGCCGTCCACTCCTCACCGTTCAGGTGCGGAAGGCATCATCGCCTTACCTCCC
interORF_Pyro_furi_347_ GCATATAAGGAGT-AGGCTCAGGAAGCCGTCCACTCCTCACCAATCAGGTGCGGAAGGCATCATCATCGCCTTCTTTACT
interORF_Pyro_hori_397_ GCATATAAGGAGT-AGGCTCAGGAAGCCGTCCACTCCTCATCATTAGGTGCGGAAGGCTTCATCATCGCCTTCTTTACT
Consensus GCAUAUAAGGAGU AGGCUCAGGAAGCCGUCCACUCCUCACCAUUCAGGUGCGGAAGGCUUCAUCAUCGCCUUAUAUACU
#=GC SS_cons <<.....<<<<<<..<<<<.....>>>>.....>>>>>>.<<<<.....>>>>>>><<<<<<.....>>>>>>>.....

```

```

interORF_Pyro_abys_654_ TTCTTCATGTAAGTTTTATAAATTAACCCGATTATTTCTCAACGATGATA----GTAGGCCTAA
interORF_Pyro_furi_347_ TTAGATTCTTATGTTTTTAATCTAATCTTGTATCTTTTTAACATTCTTA---CGTCAAATAAT
interORF_Pyro_hori_397_ TTATTGTTAAAAGTTT-ATAAGGTAACTAATAGCATTTAAACAGCTAGAATTTGTAAACTTAA
Consensus UUAUUCUUAUAAGUUUUAUAUAACUAAACUAAUAACUUUUAACAAUCAUA___GUAAACUUA
#=GC SS_cons .....
//

```

Stockholm

ARN à boîtes C/D

RNAz, RNAalifold

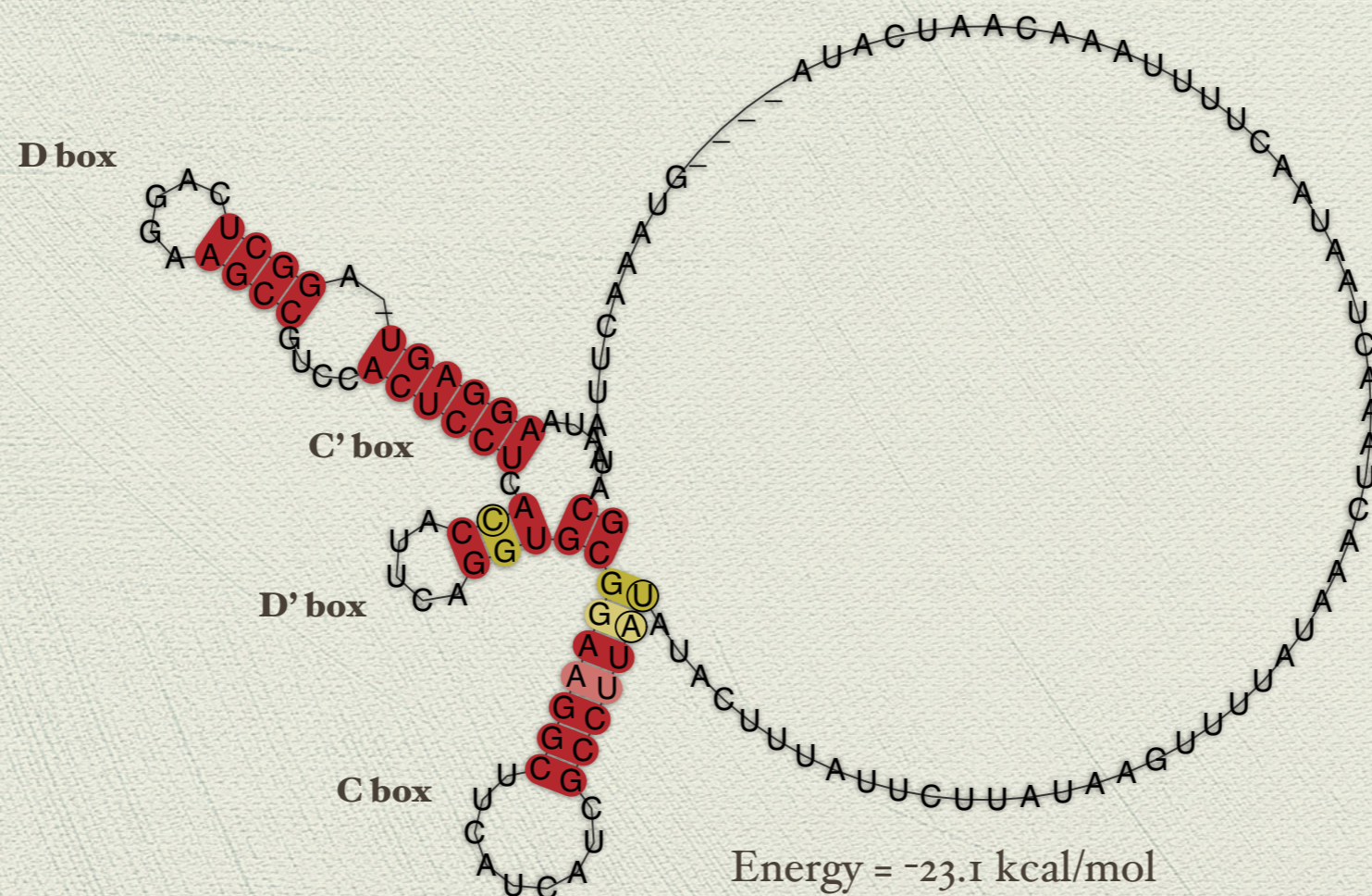
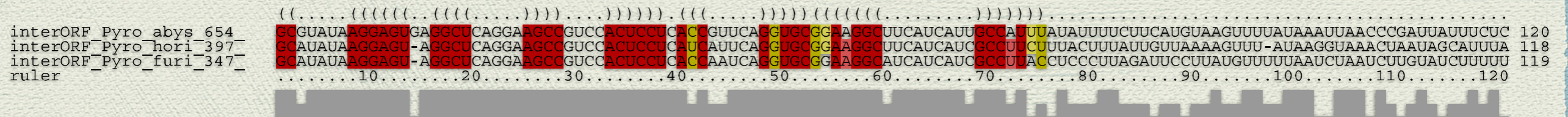

Clustal; Vienna/DBN

Diagrammes Arc

covariations, conservation

R-Chie

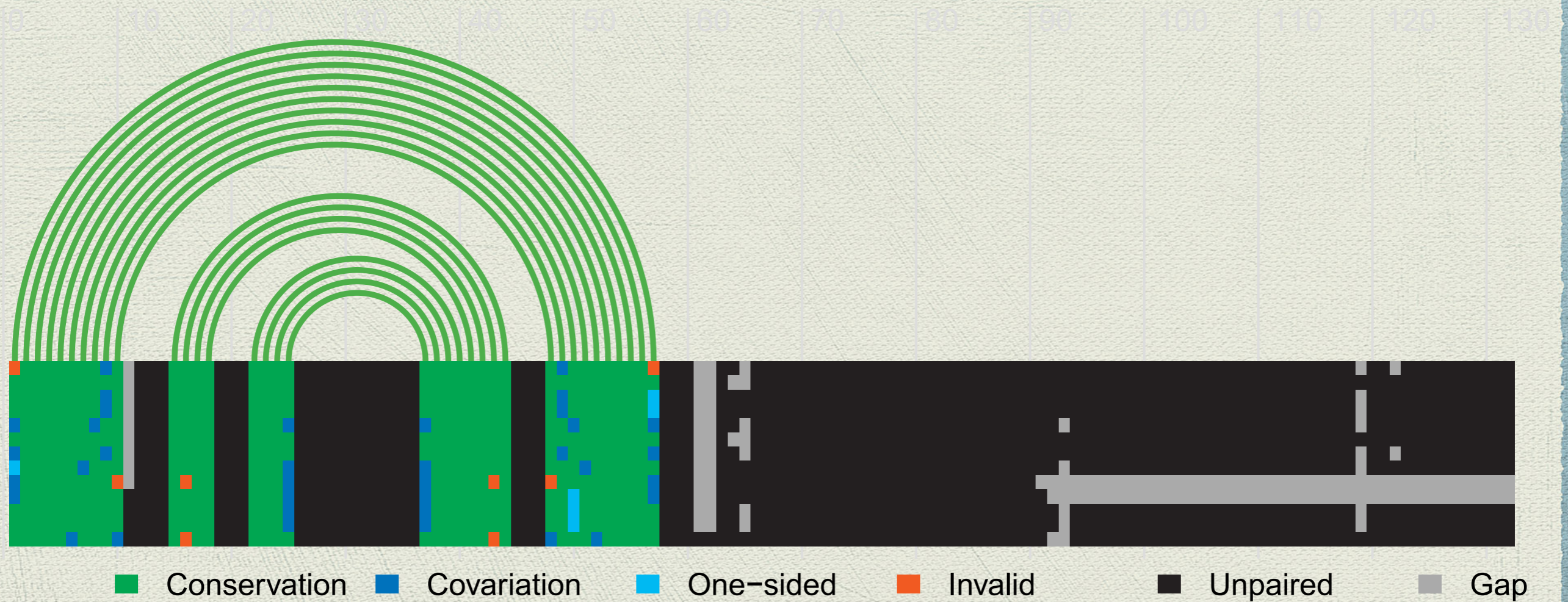

RFAM: RF00065

Stockholm

ARN à boîtes C/D

RNAz, RNAalifold

Pab C/D sRNA sRI

	5'		C box		D' box	C' box		D box	3'				
	((.....	((((((((((.....))			
interORF_Pyro_hori_397	AAAGAA	GGC	GAUGAU	GAAGCCU	UCCGC	ACCU	GAAUGAUG	AGGAGUGGAC	GGCUUC	CUGAG CCU 63			
interORF_Pyro_abys_654	AUAAAU	GGC	AAUGAU	GAAGCCU	UCCGC	ACCU	GAACGGUG	AGGAGUGGAC	GGCUUC	CUGAG CCU 63			
interORF_Pyro_furi_347	AGGUAA	GGC	GAUGAU	GAU	GCCU	UCCGC	ACCU	GAUUGGUG	AGGAGUGGAC	GGCUUC	CUGAG CCU 63		
ruler	10	20	30	40	50	60	...

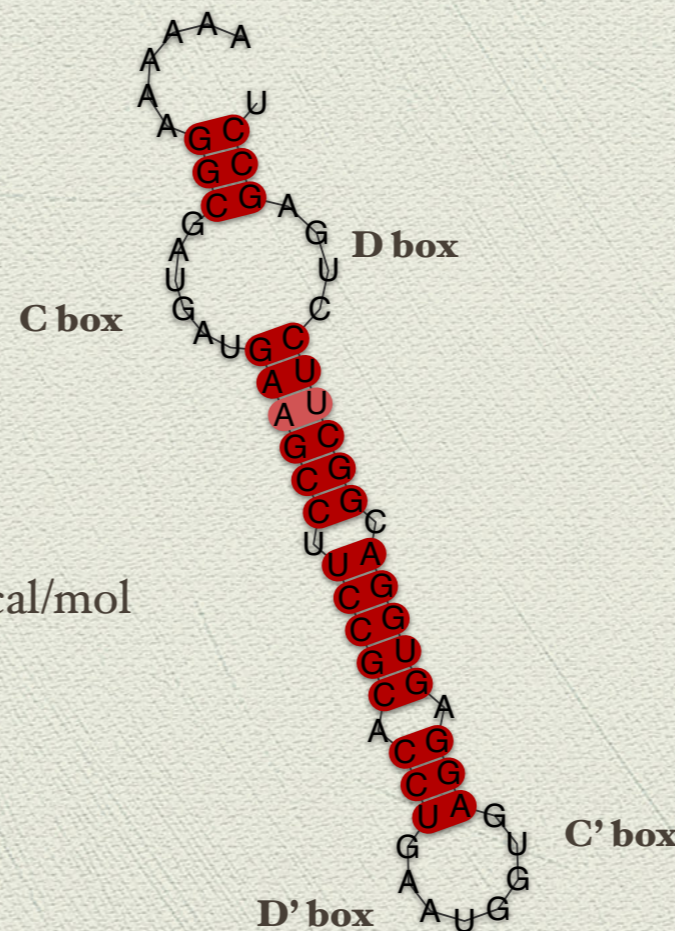
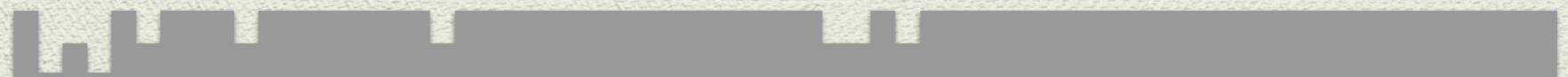

Energy = -24.6 kcal/mol

Clustal; Vienna/DBN

ARN à boîtes H/ACA

RNAz, RNAalifold

Pho21 215834-215776 -
Pfu21 163991-163933 -
Pab21 230575-230517 -

Pab-21 H/ACA sRNA

((((((((.....((((.....((((.....)))))).....)))))).....)))))).....
CGGCCCGGUUCCC GCCUCUC CCGGGGAAUCGUGAA CCGGGGGUUC GACCGGGCCGACA
GGGCCCGGUUCCC GCCUCUC CCGGGGAAUCGUGAA CCGGGGGUUC GACCGGGCCGACA
GGGCCCGGCUCCC GCCUCUC CCGGGGAAUCGUGAA CCGGGGGUUC GGCCCGGGCCUACA

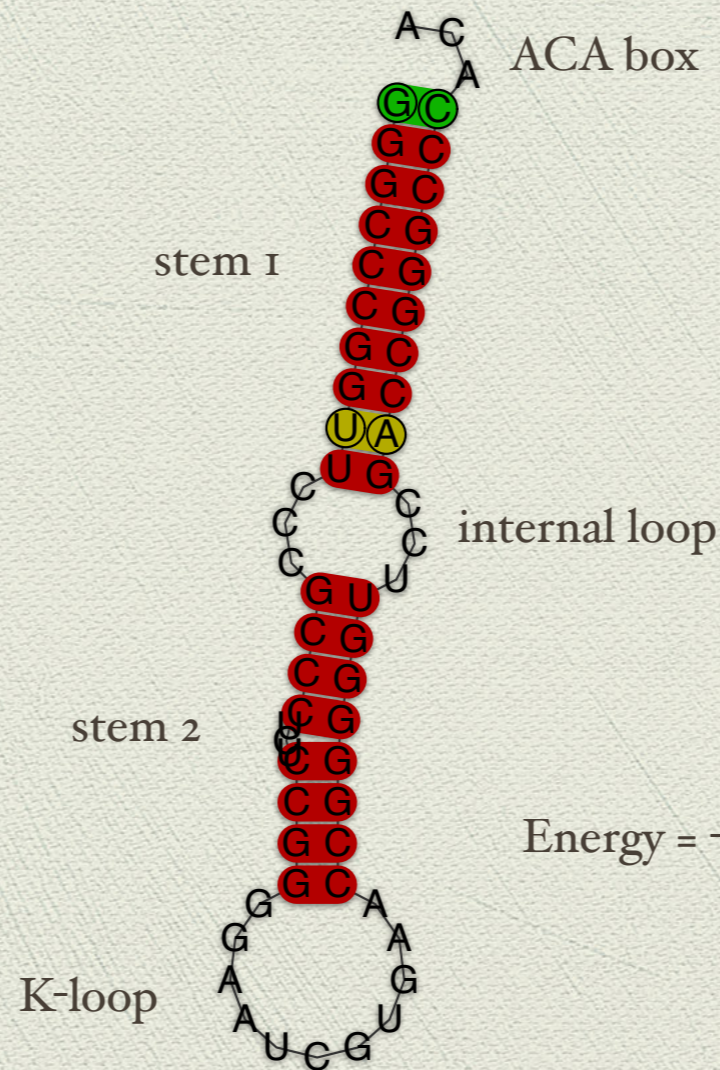

Clustal; Vienna/DBN

ARN à boîtes (H/ACA)_n

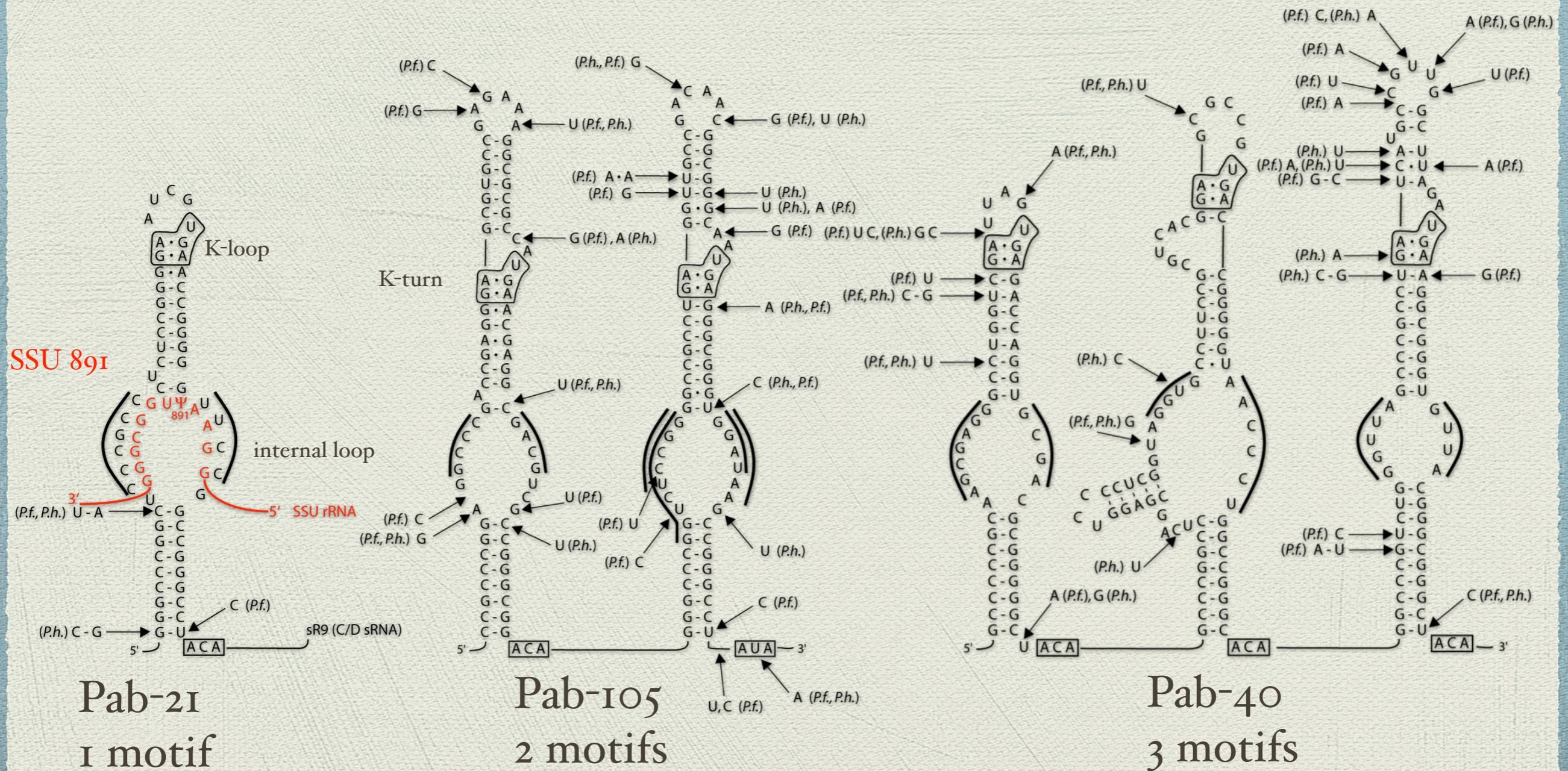

ARN à boîtes (H/ACA)³

Pab-40 H/ACA sRNA

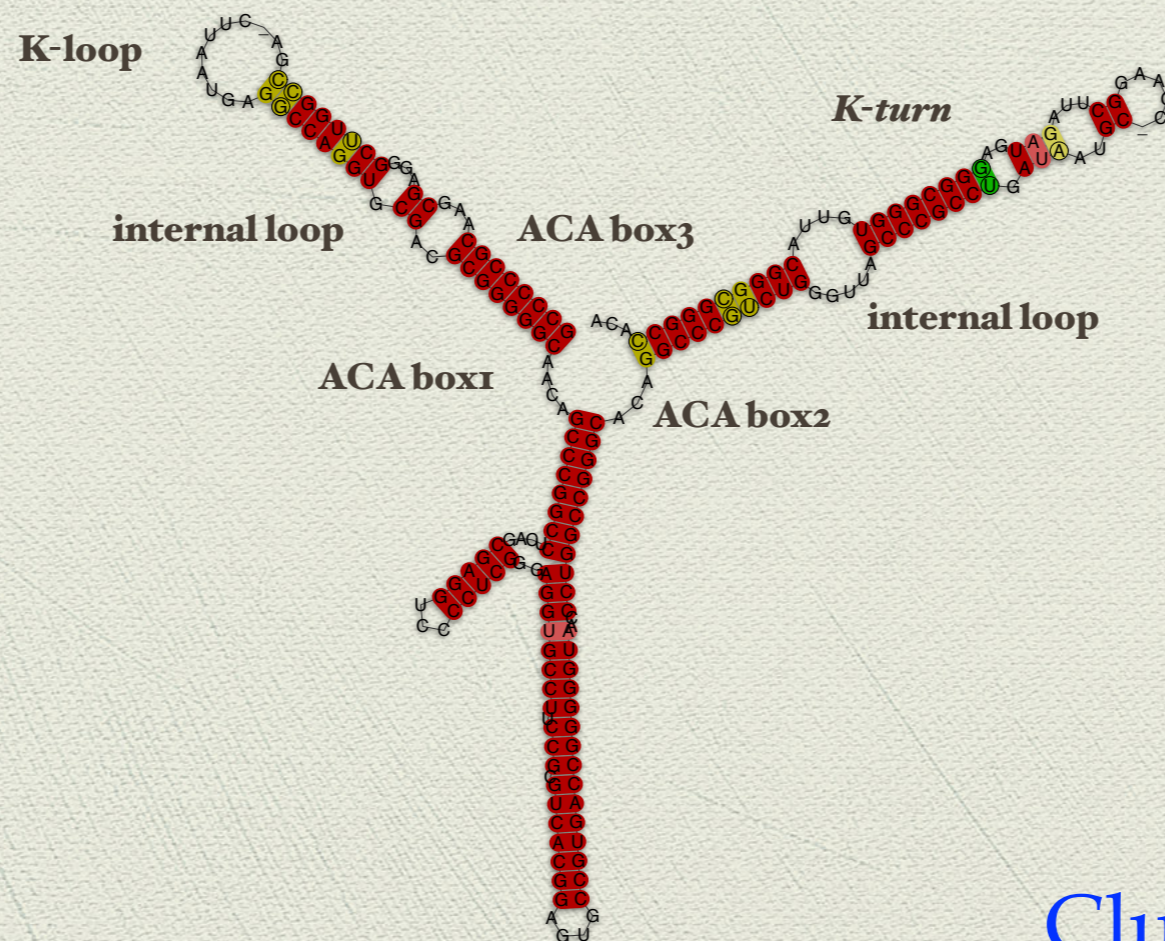
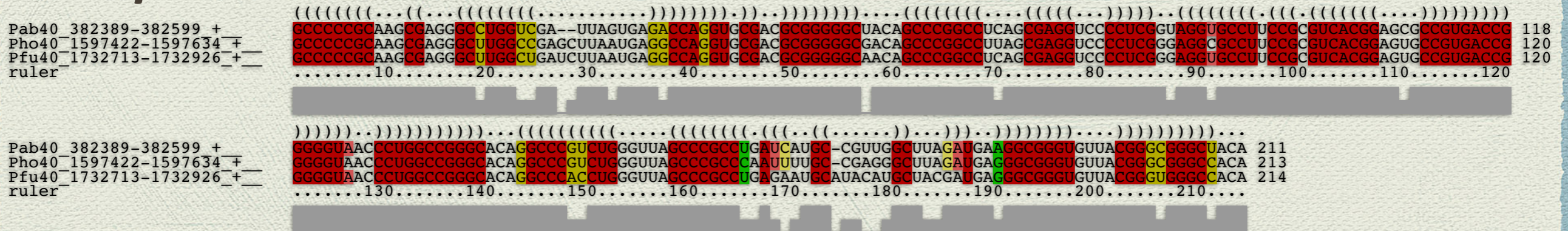

Clustal; Vienna/DBN

Comparaison 2D

arbre de proximités
entre structures 2D

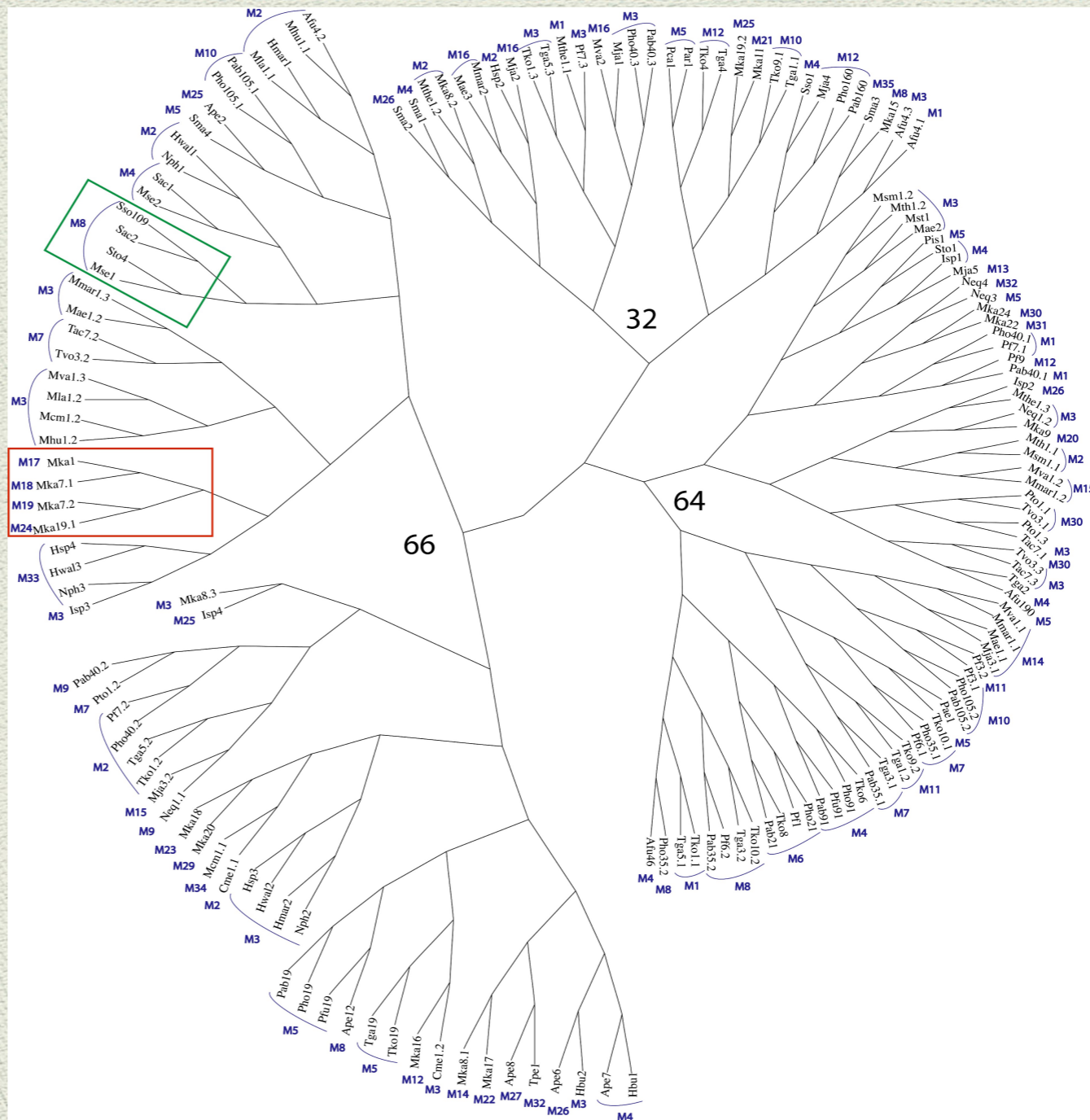

Graphes

(((((((.....)))))).....((((.....)))))).....

tRNA

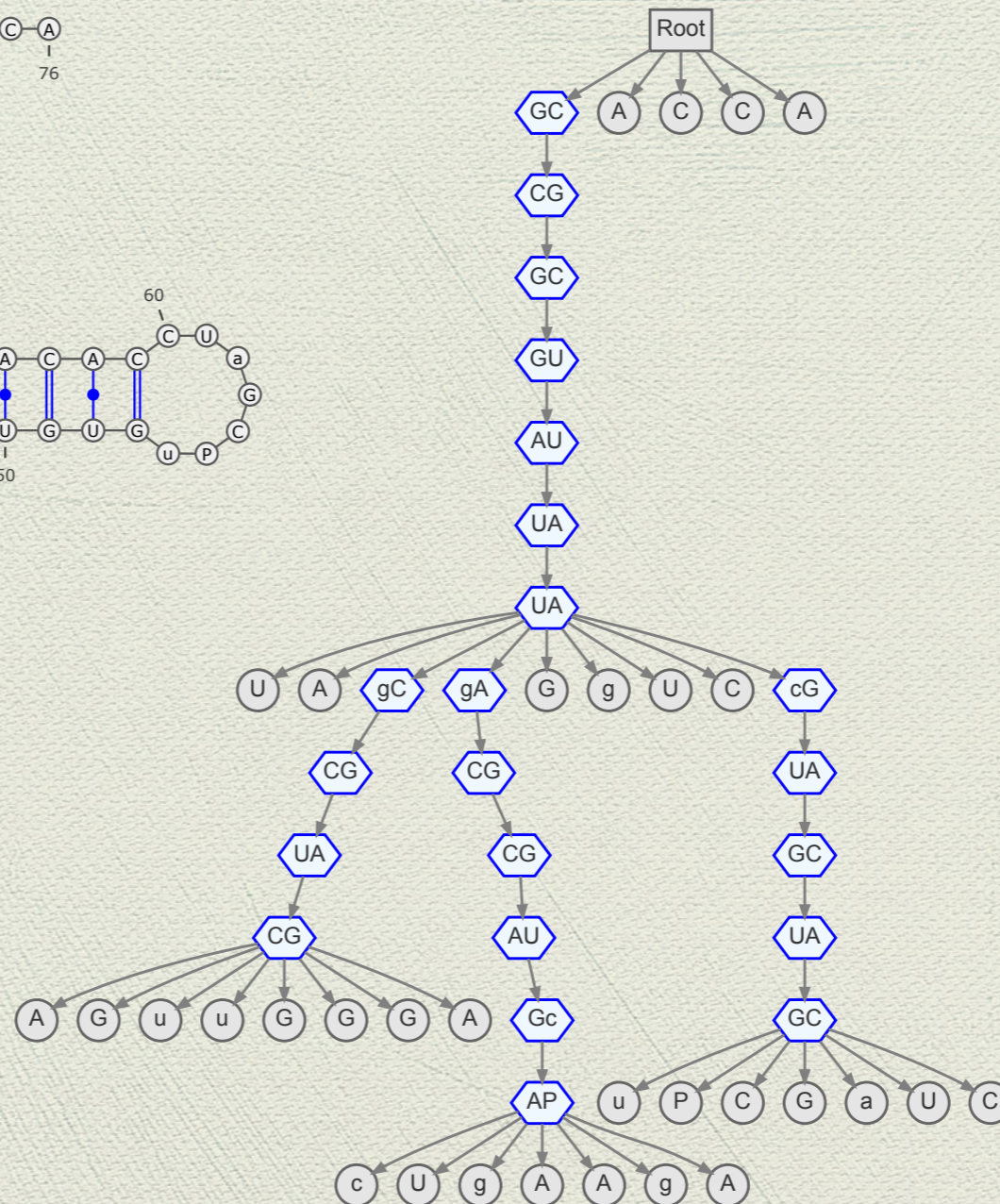
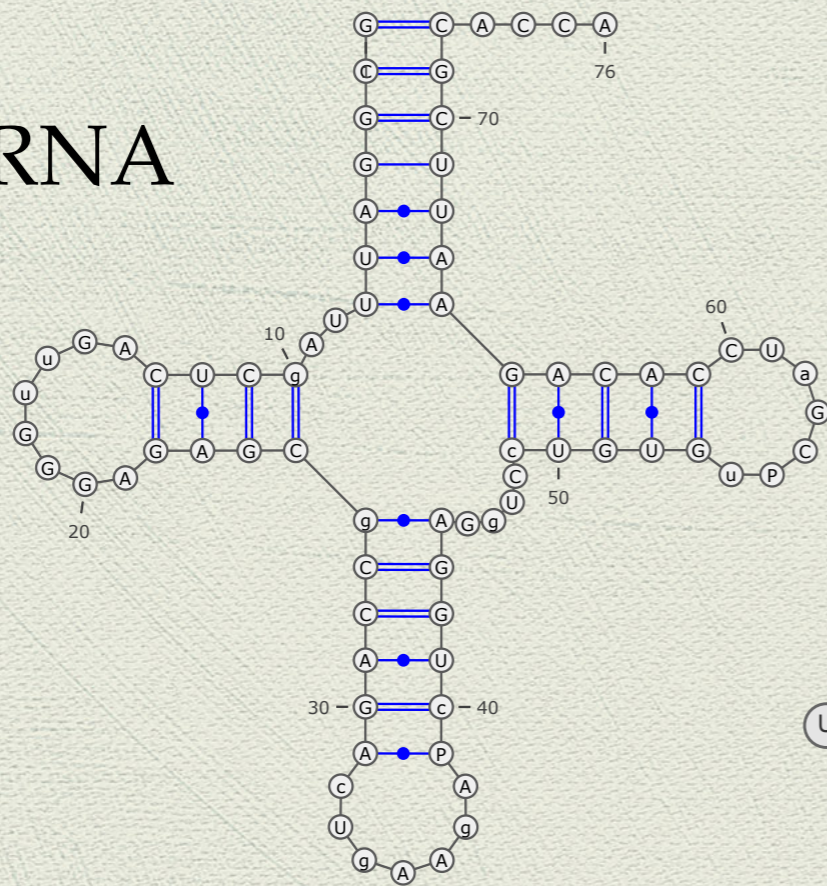

VARNA

Graphiz
(RNAView)

Empreintes

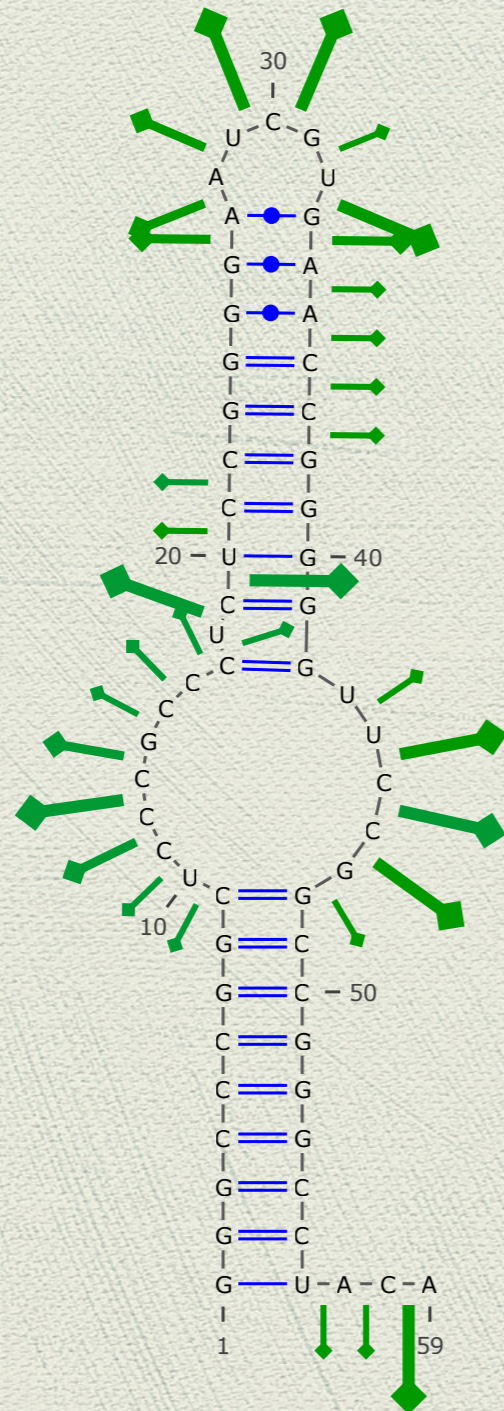

VARNA

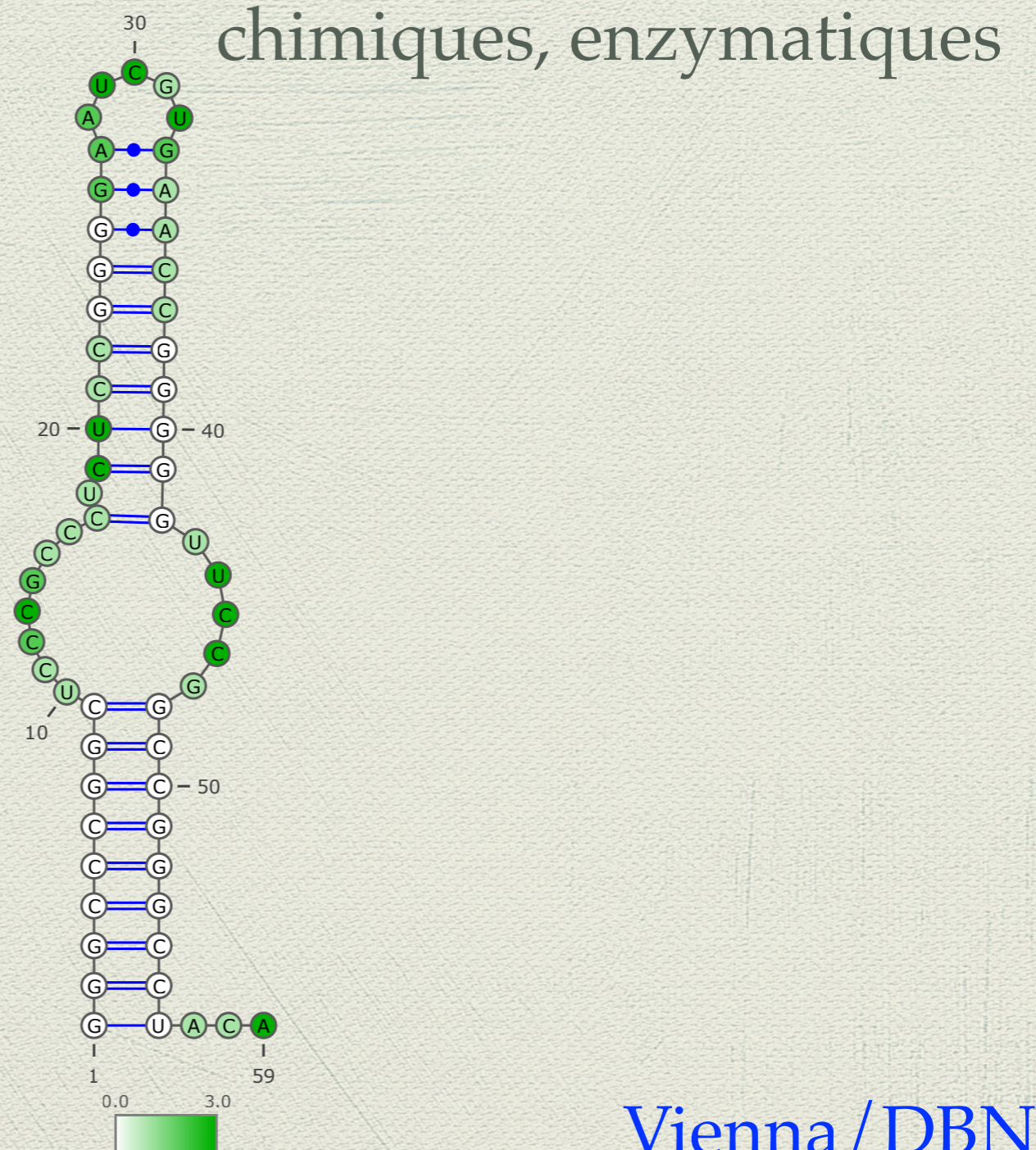

Données fonctionnelles¹

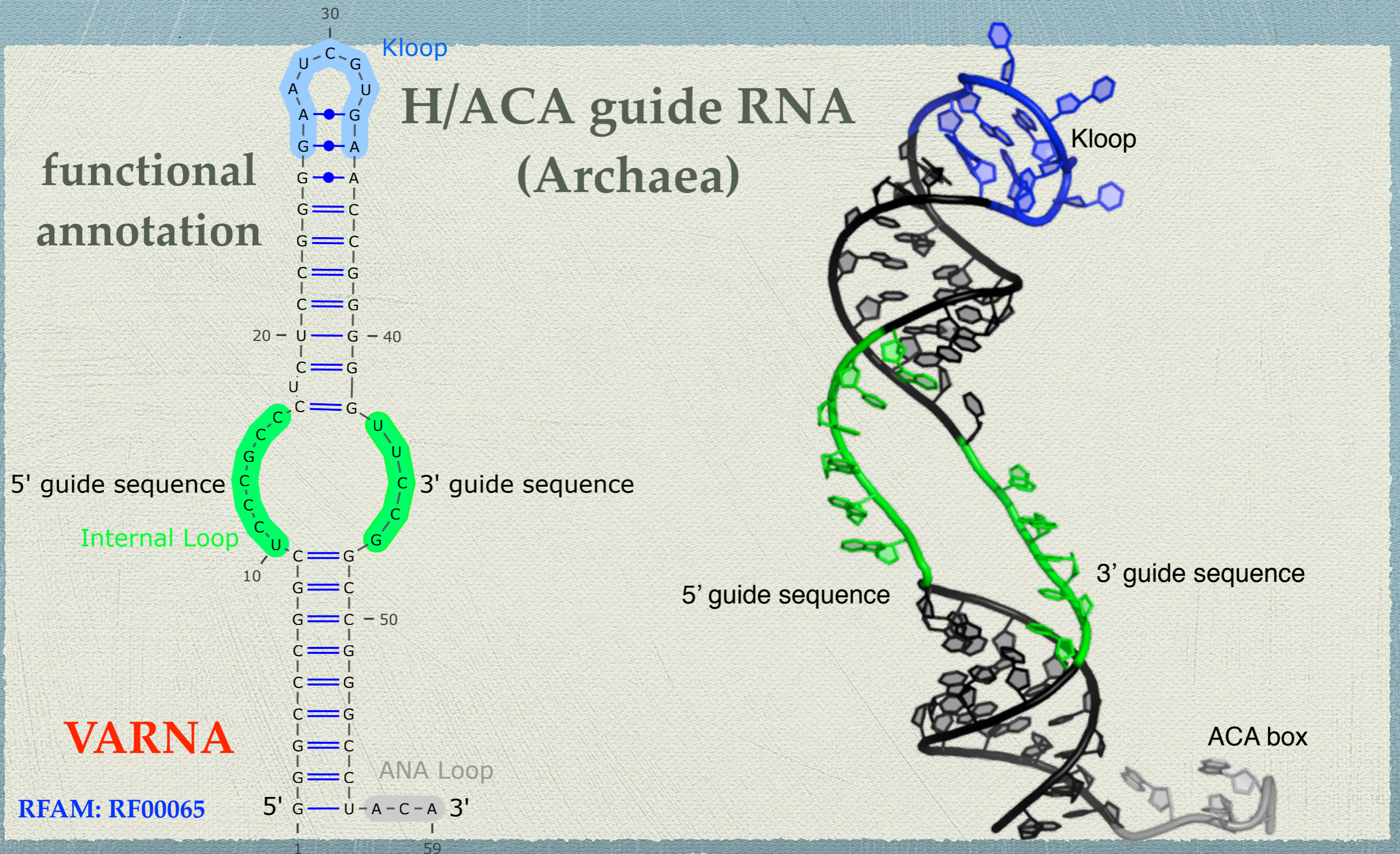

Données fonctionnelles²

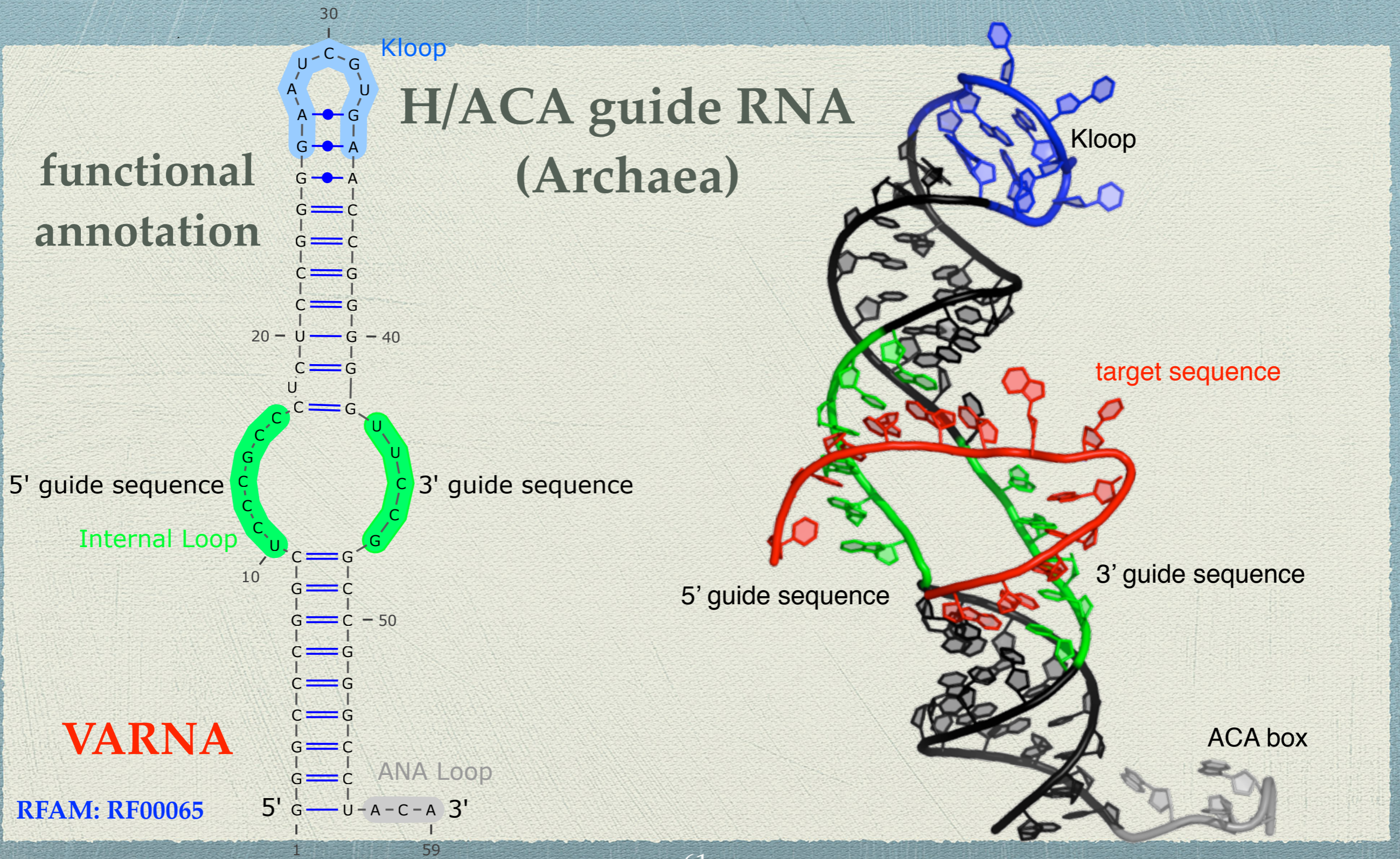

Données fonctionnelles³

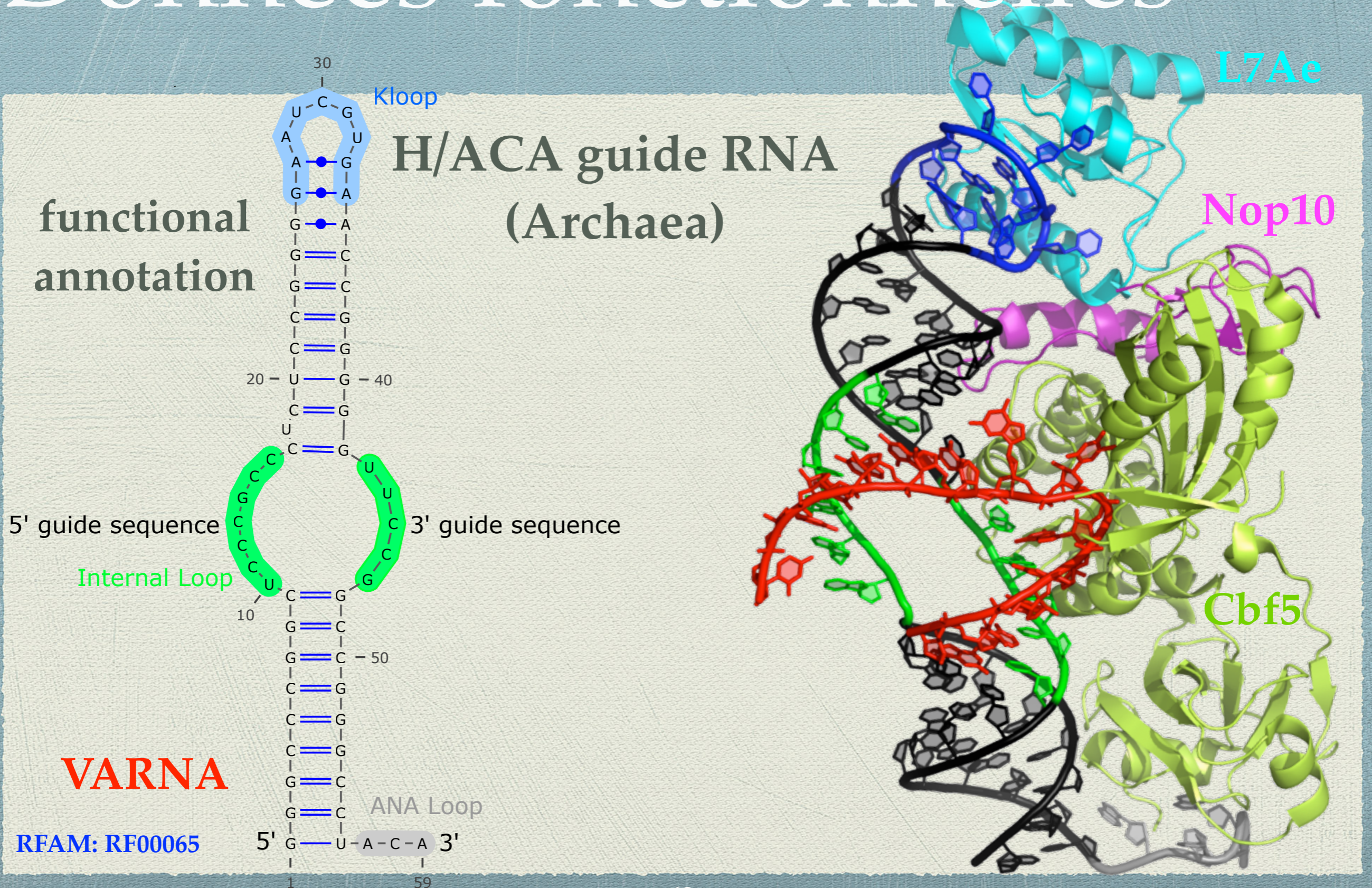

Modifications d'accessibilité

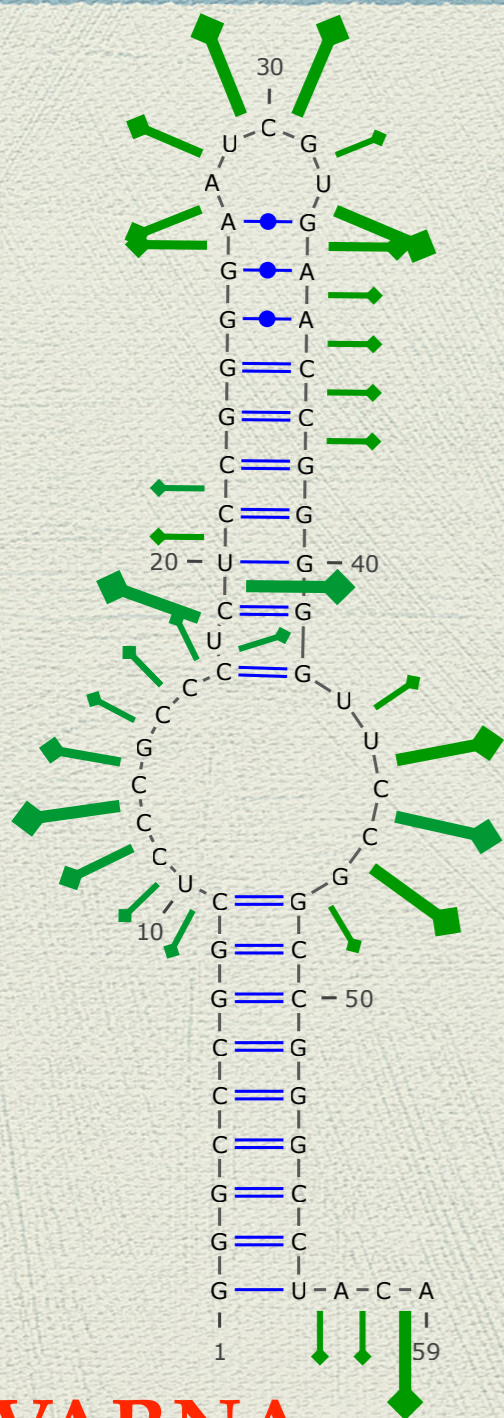

VARNA

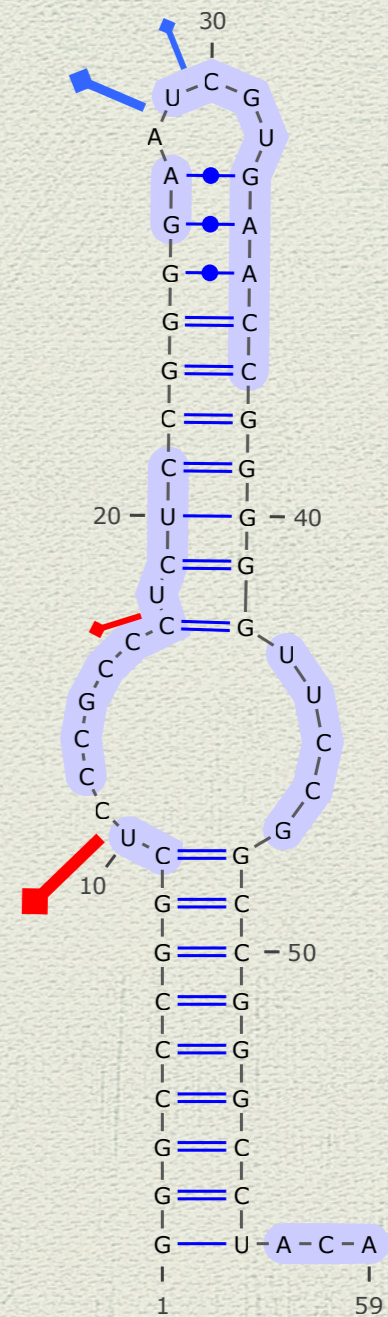
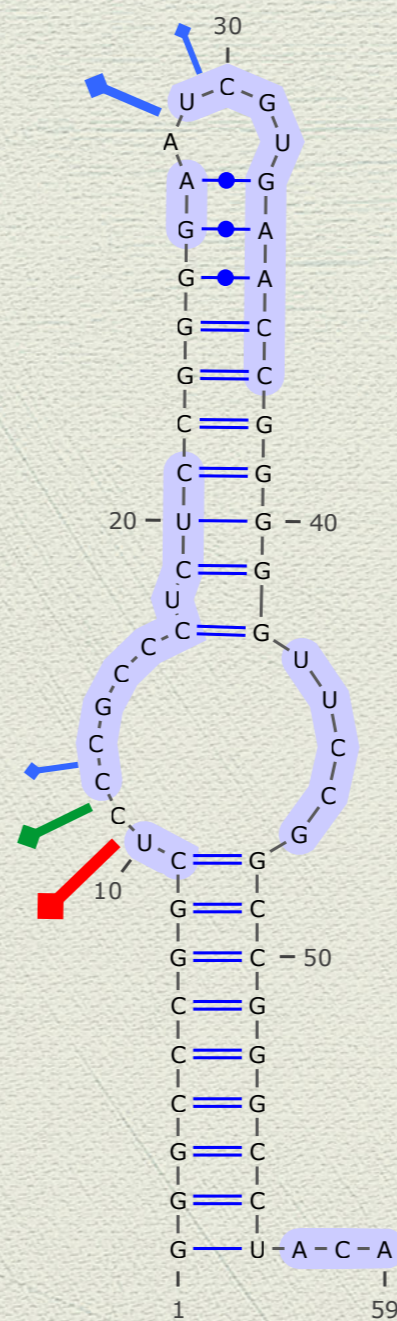
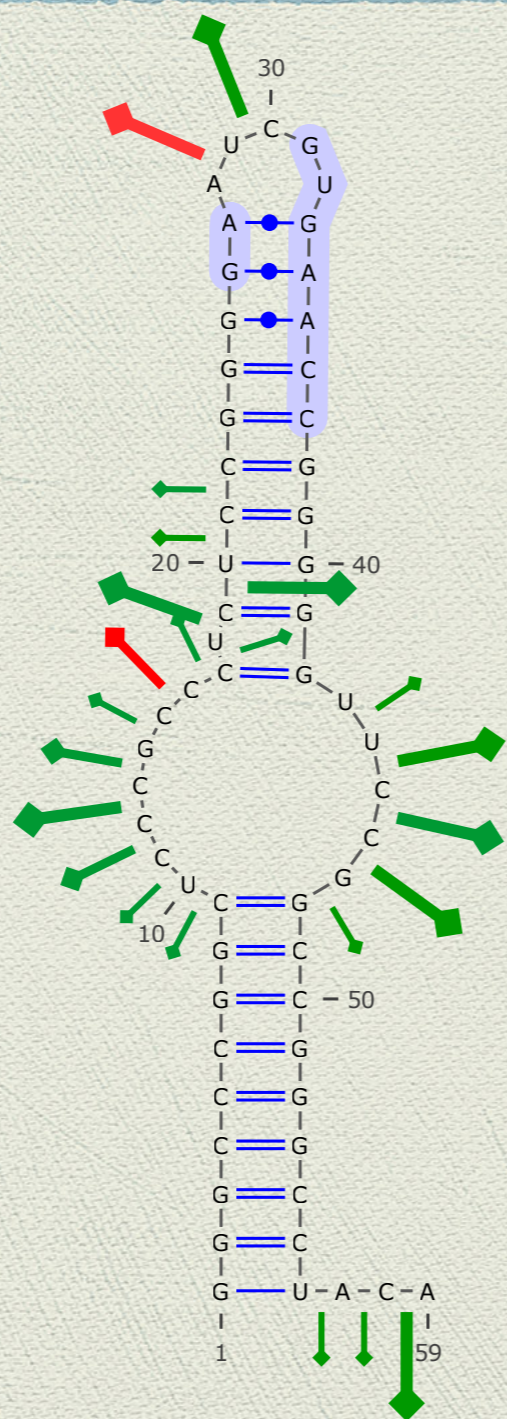

Vienna/DBN

Données d'empreintes¹

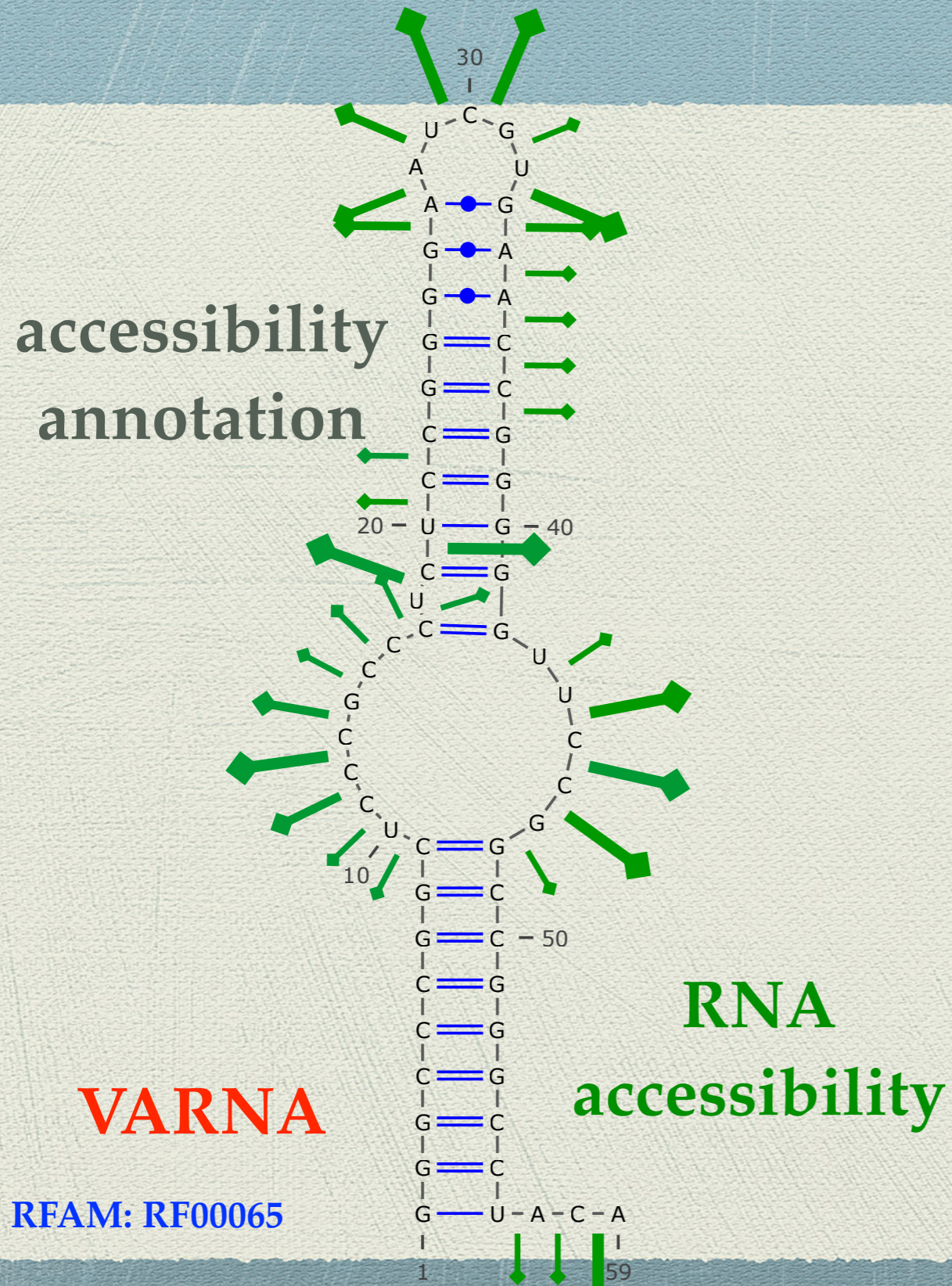

Données d'empreintes²

accessibility
annotation

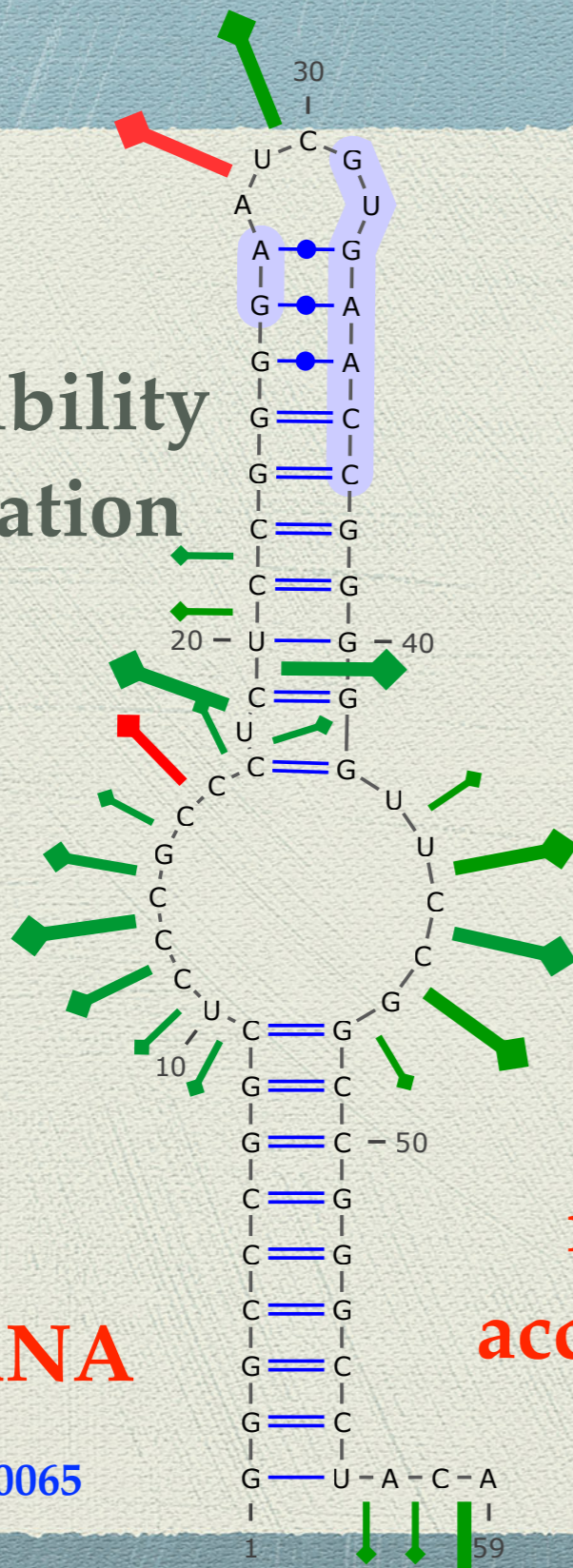

VARNA

**more
accessible**

RFAM: RF00065

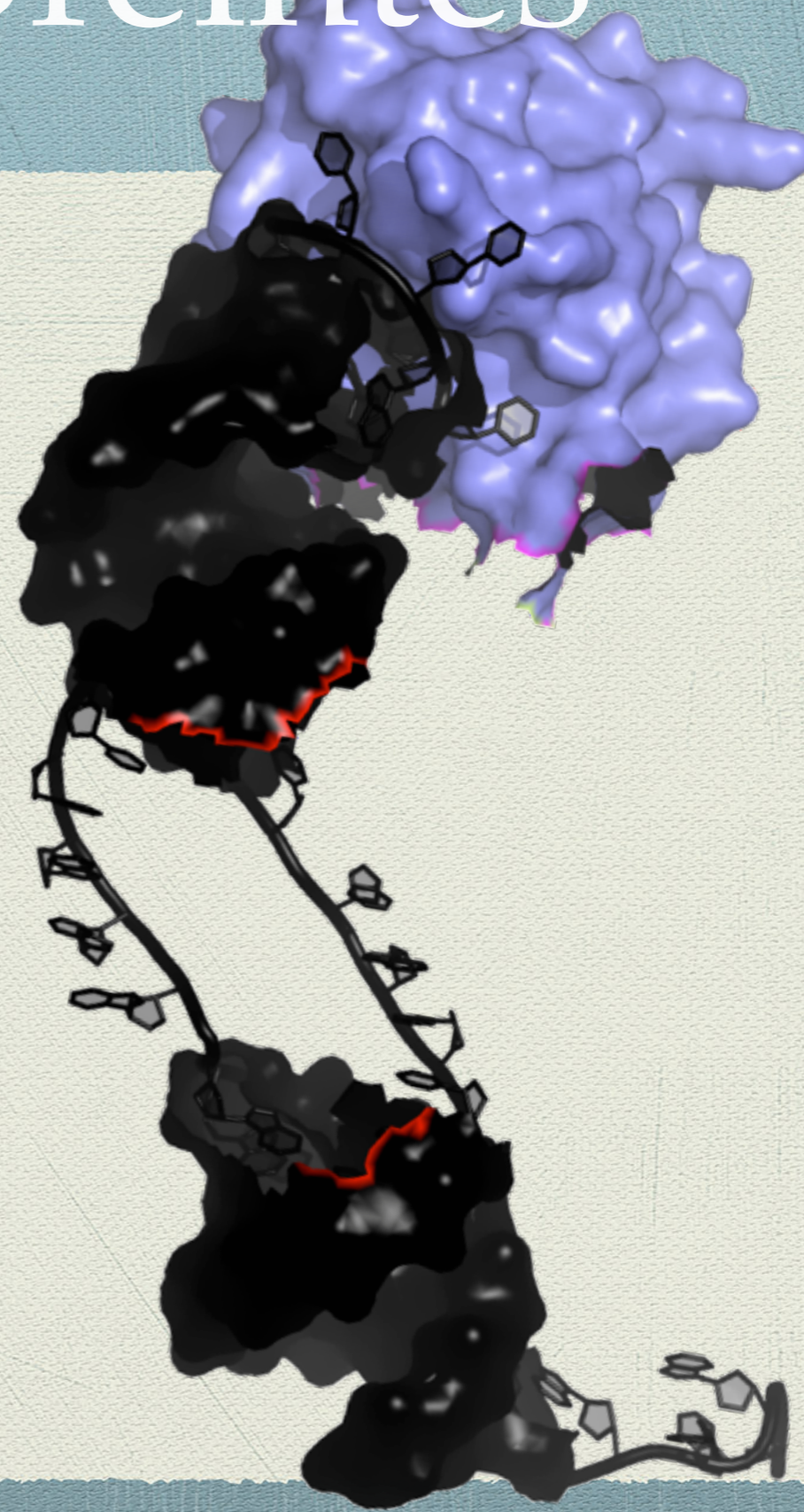

Données d'empreintes³

accessibility
annotation

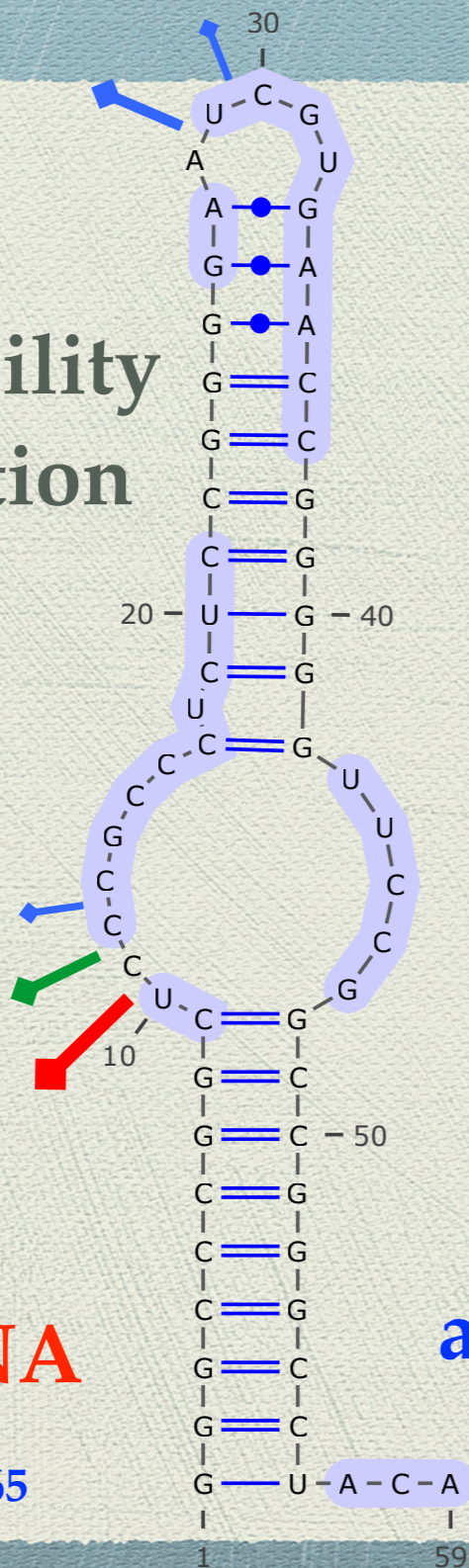

VARNA

less
accessible

RFAM: RF00065

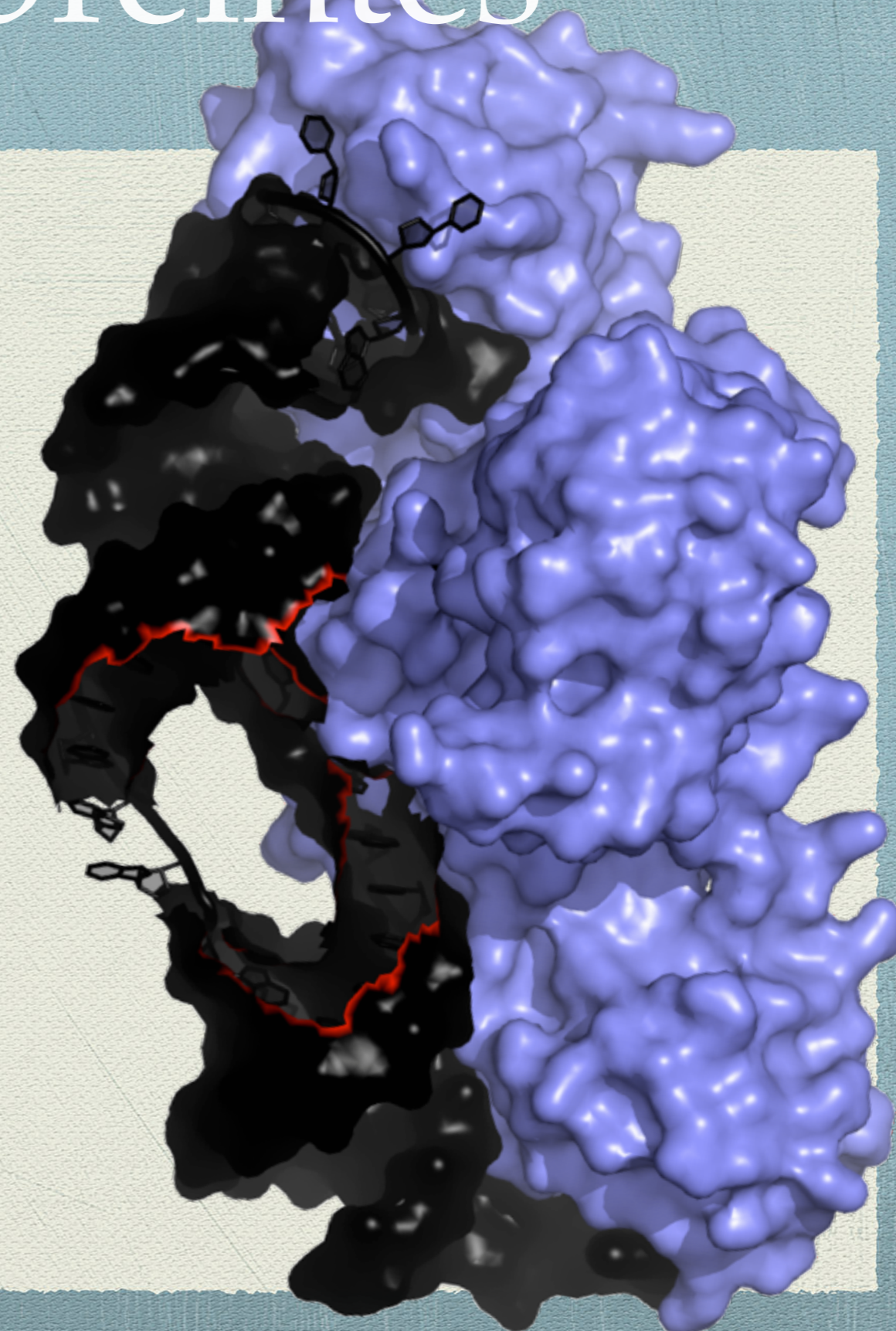

Données d'empreintes⁴

accessibility
annotation

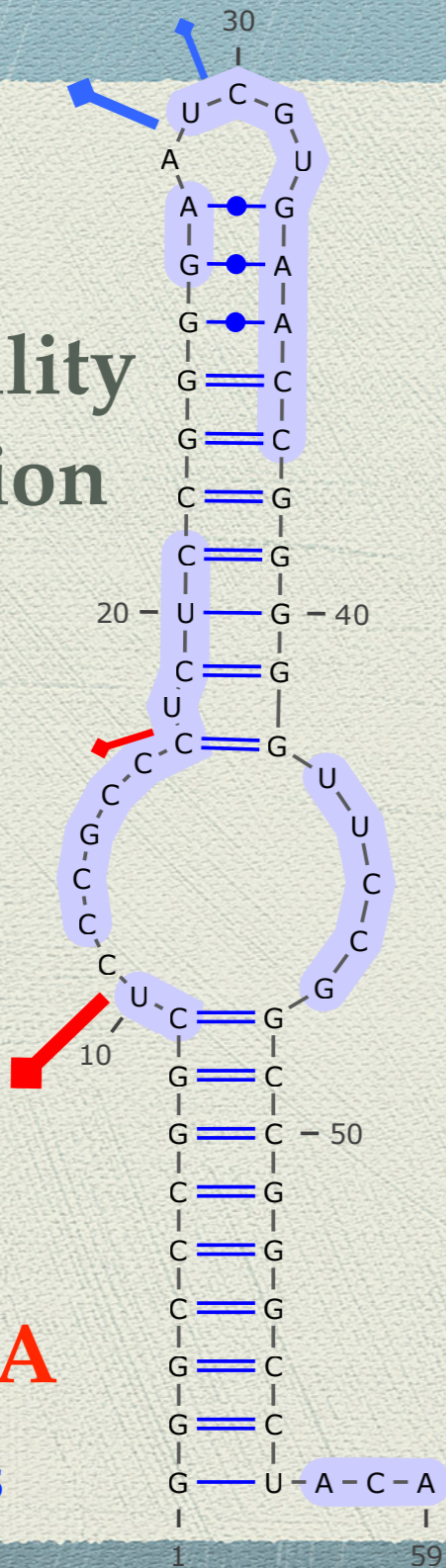

VARNA

RFAM: RF00065

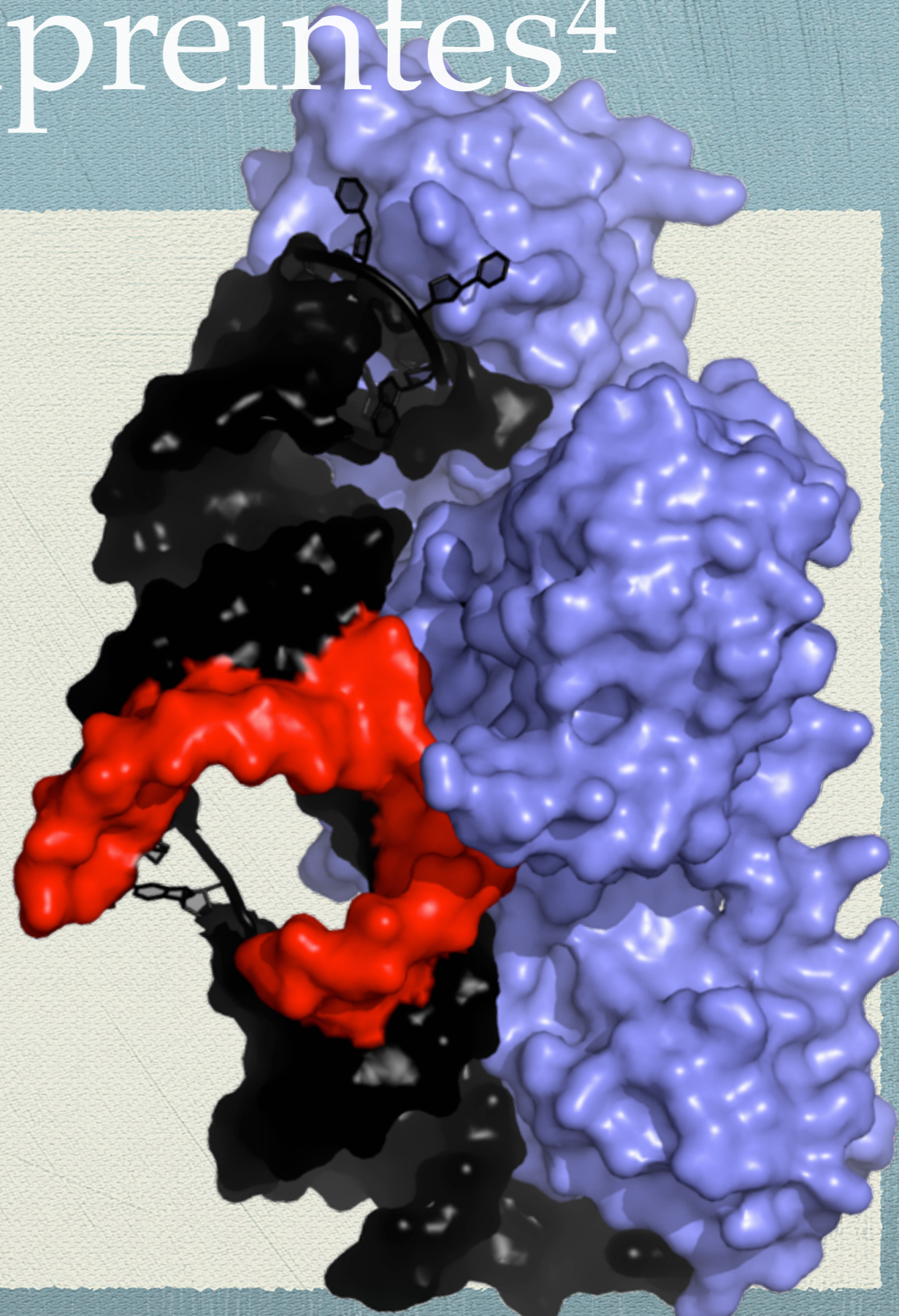

Interactions ARN-ARN

A RILogo

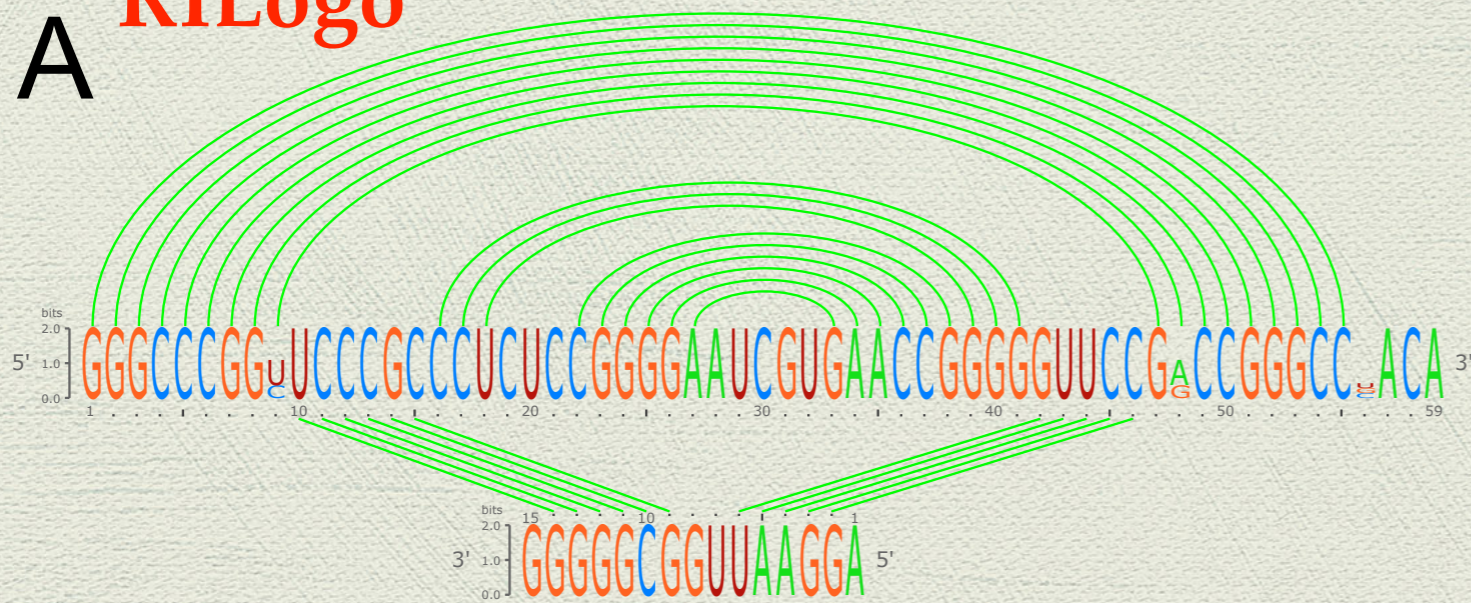

C VARNA

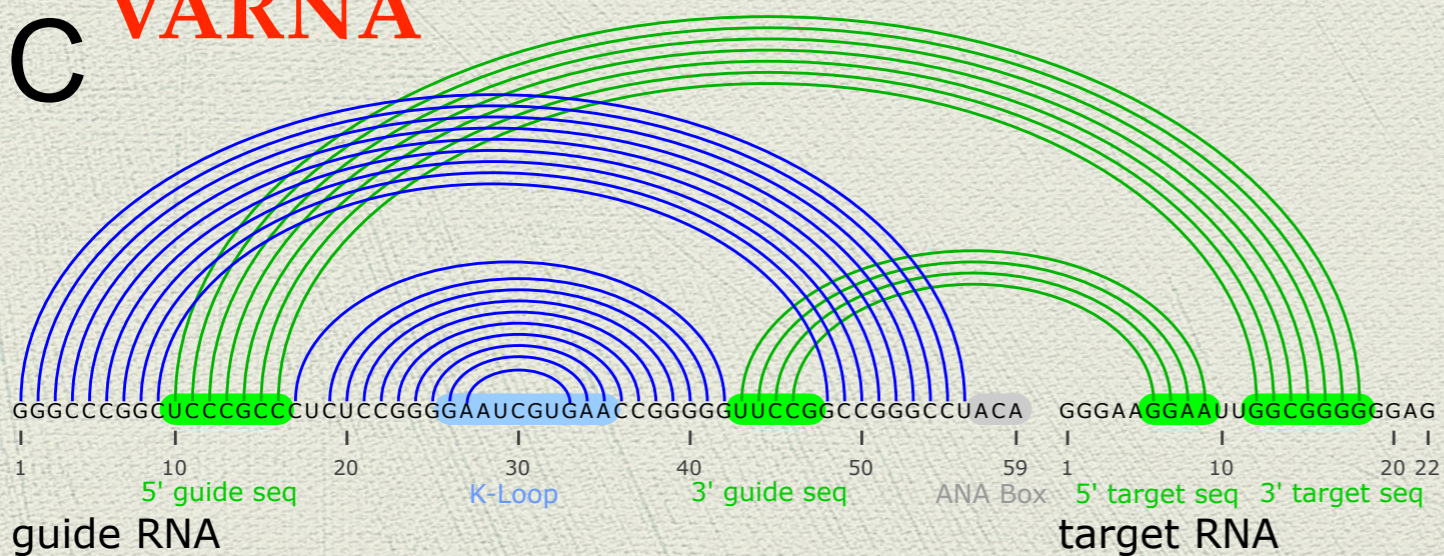

RFAM: RF00065

Vienna/DBN

R2R*

Stockholm

B

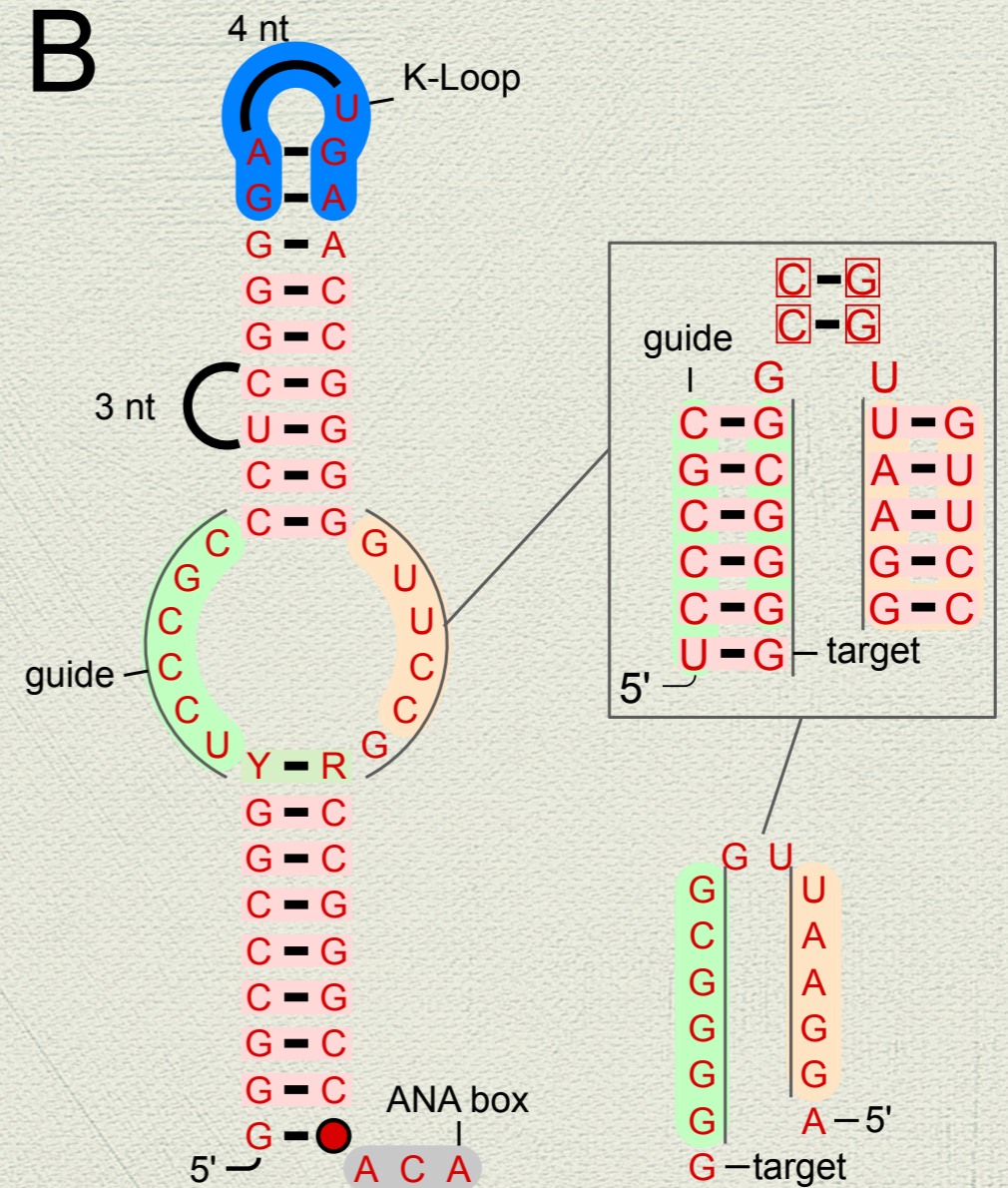

* post-processing

Gènes H/ACA

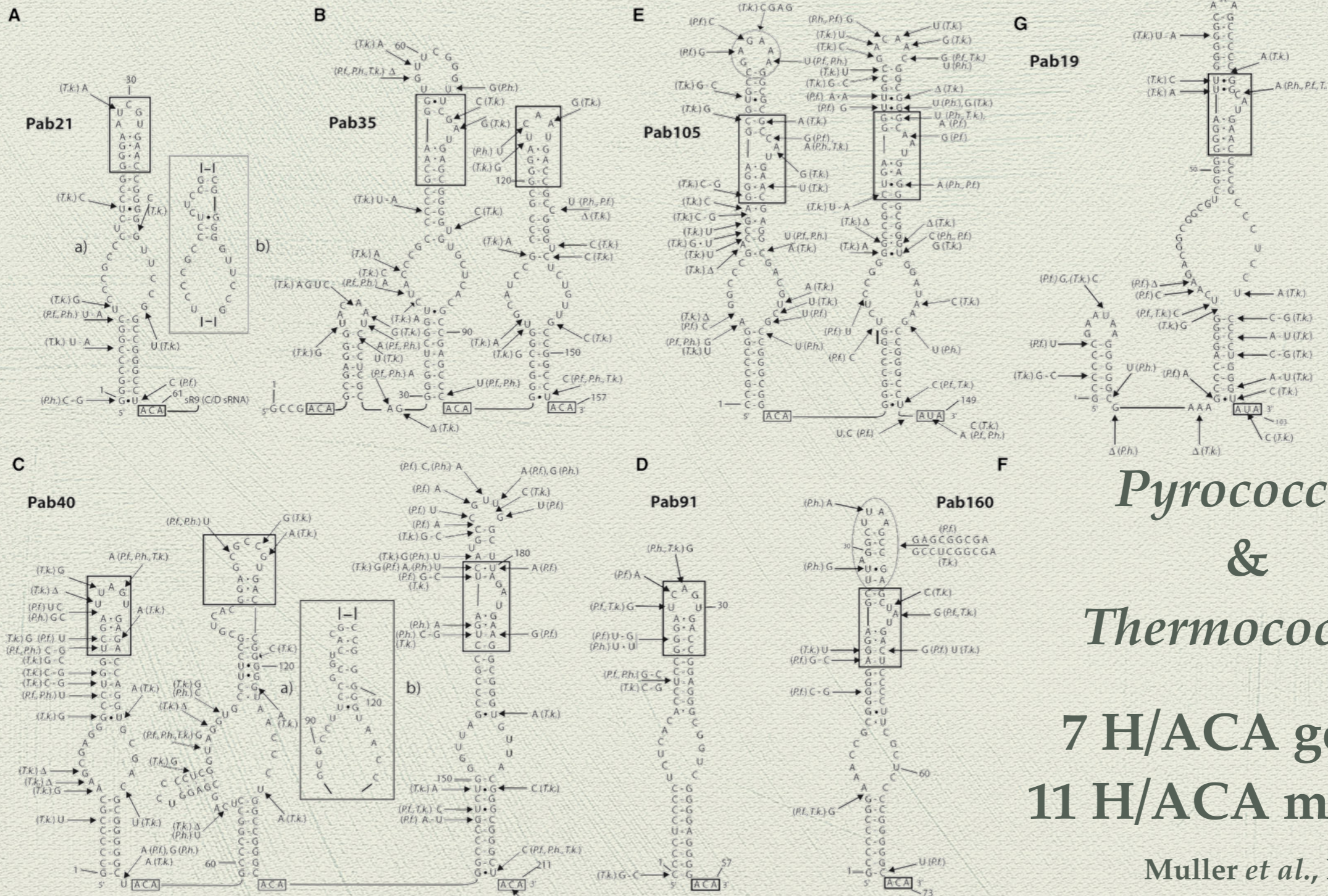

Pyrococcus
&
Thermococcus

7 H/ACA genes
11 H/ACA motifs

Muller et al., NAR, 2008

Fonction des H/ACA

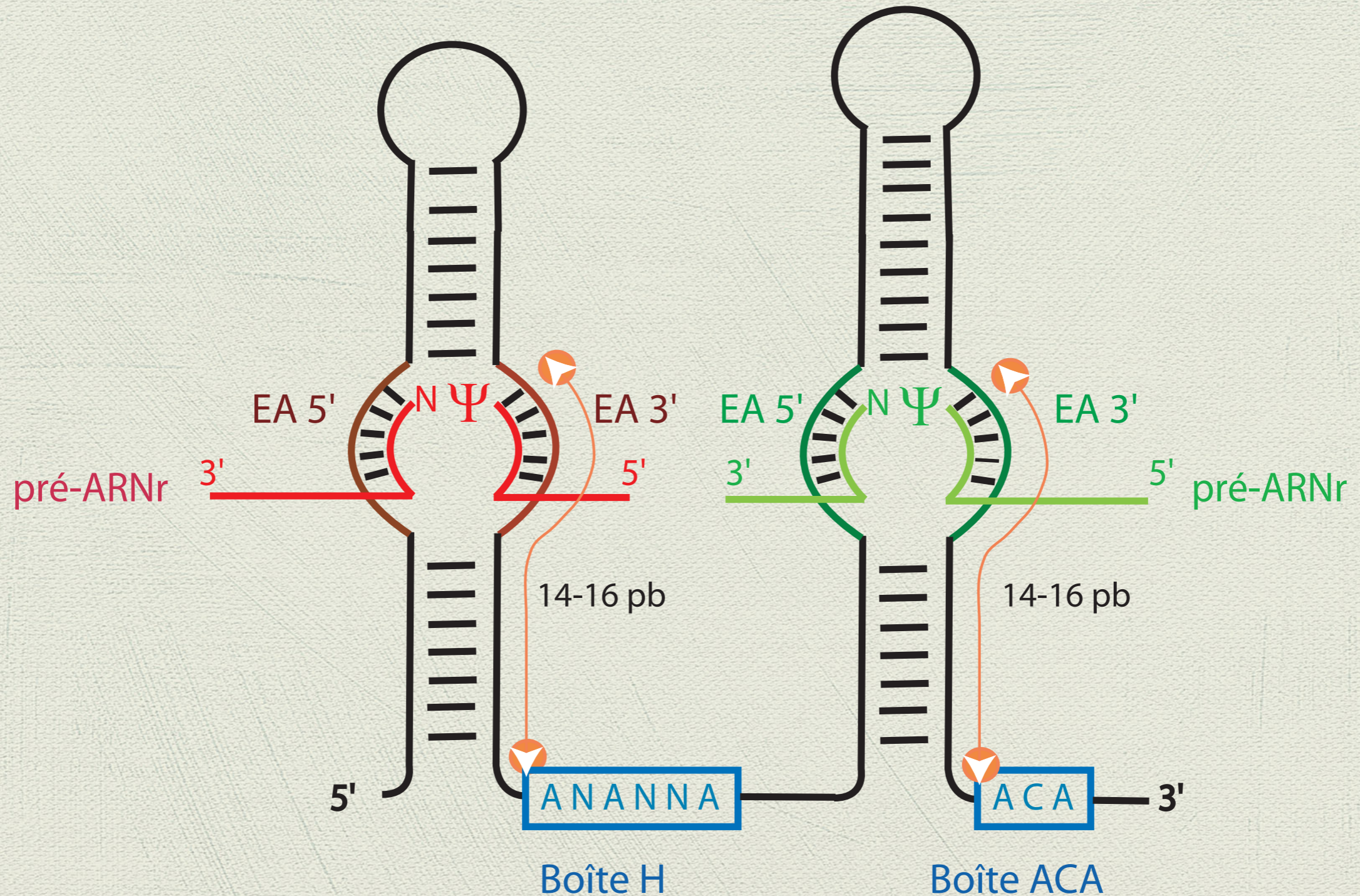

Gènes H/ACA

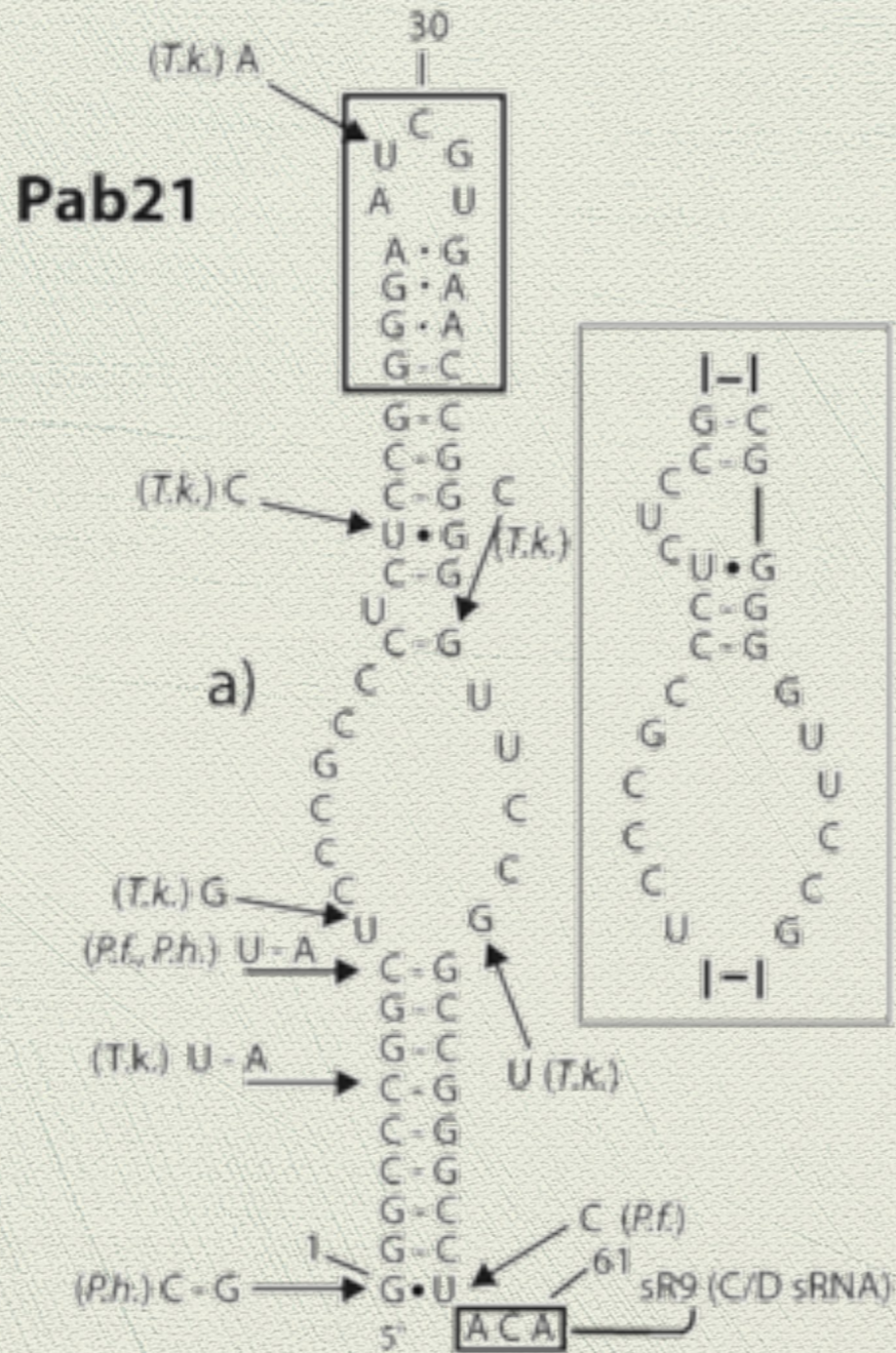

Pyrococcus
&
Thermococcus

7 H/ACA genes
11 H/ACA motifs

Muller *et al.*, NAR, 2008

H/ACA et leur(s) cible(s)

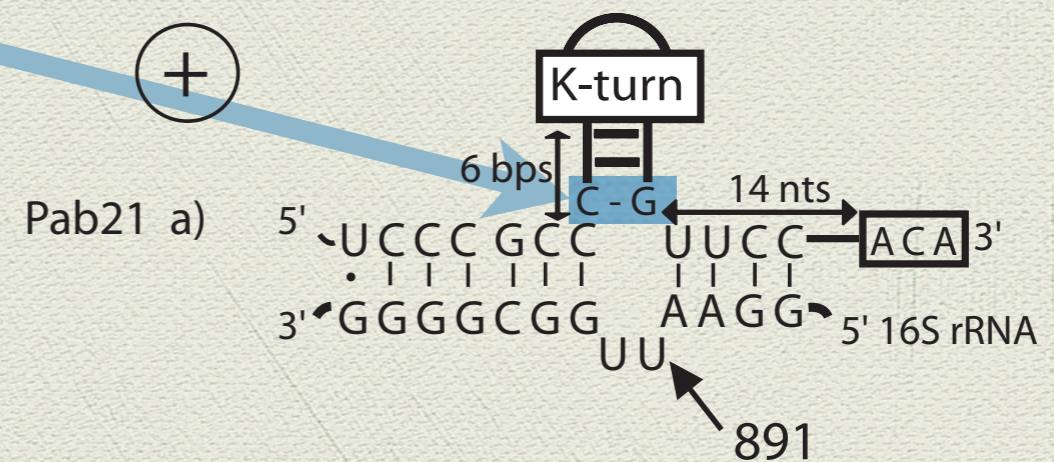
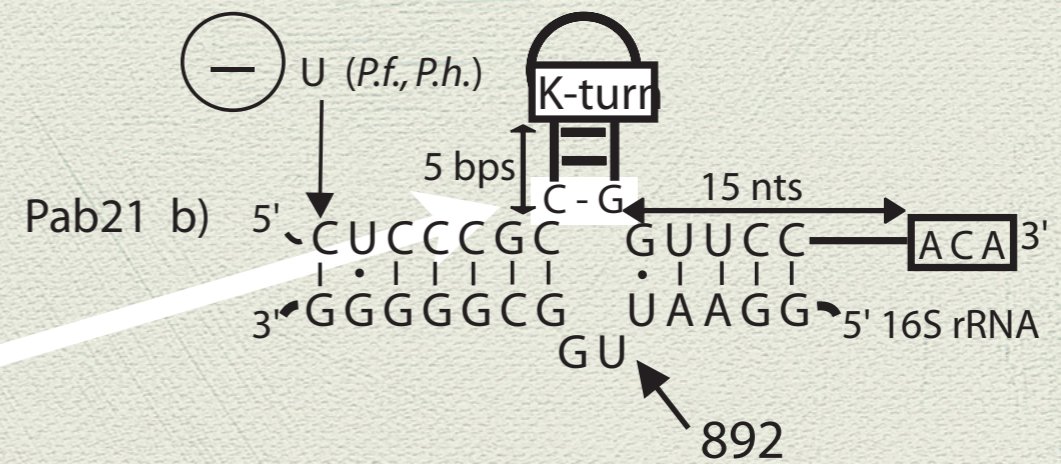
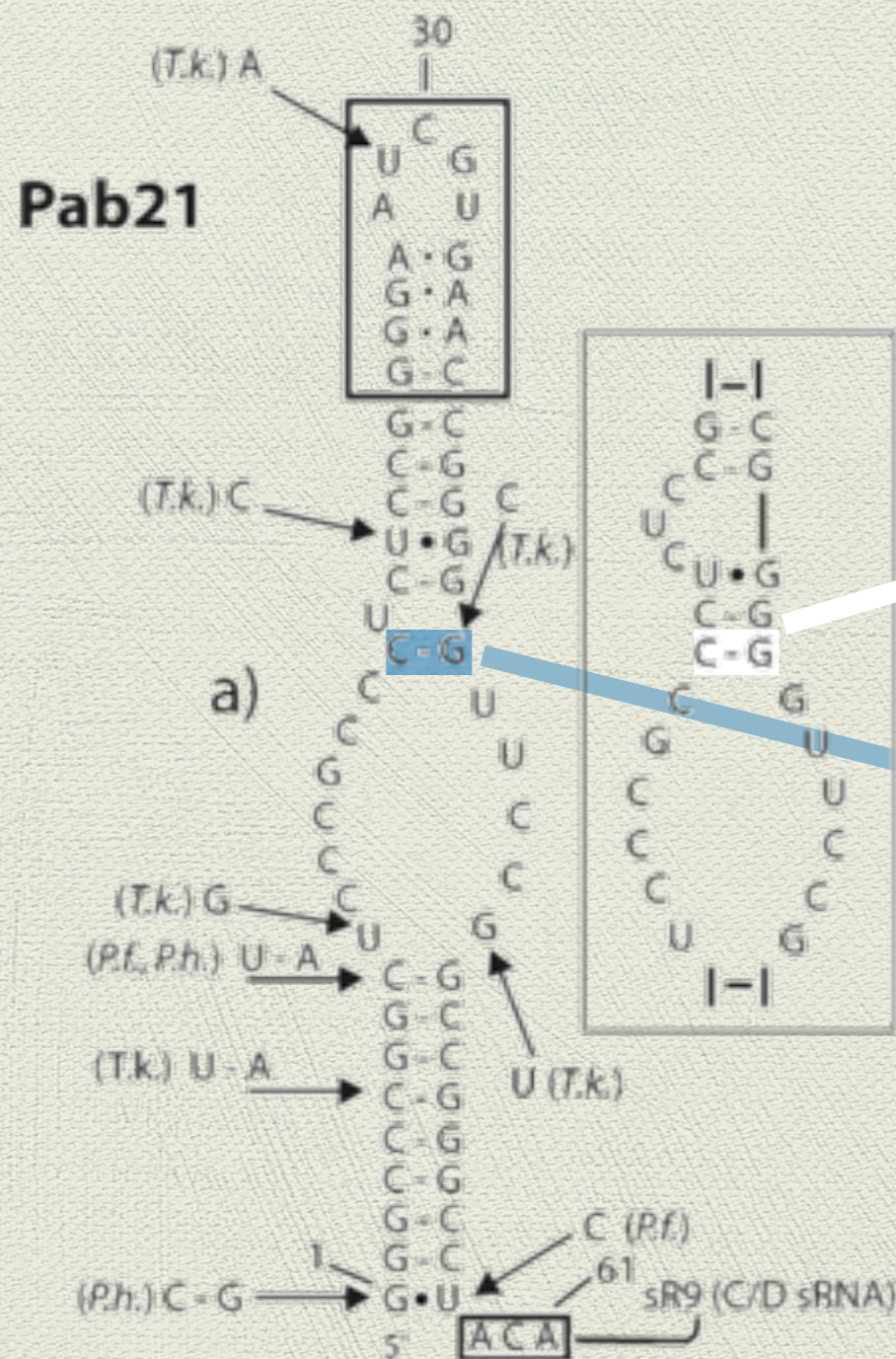

Muller *et al.*, NAR, 2008

H/ACA: Structure-Function

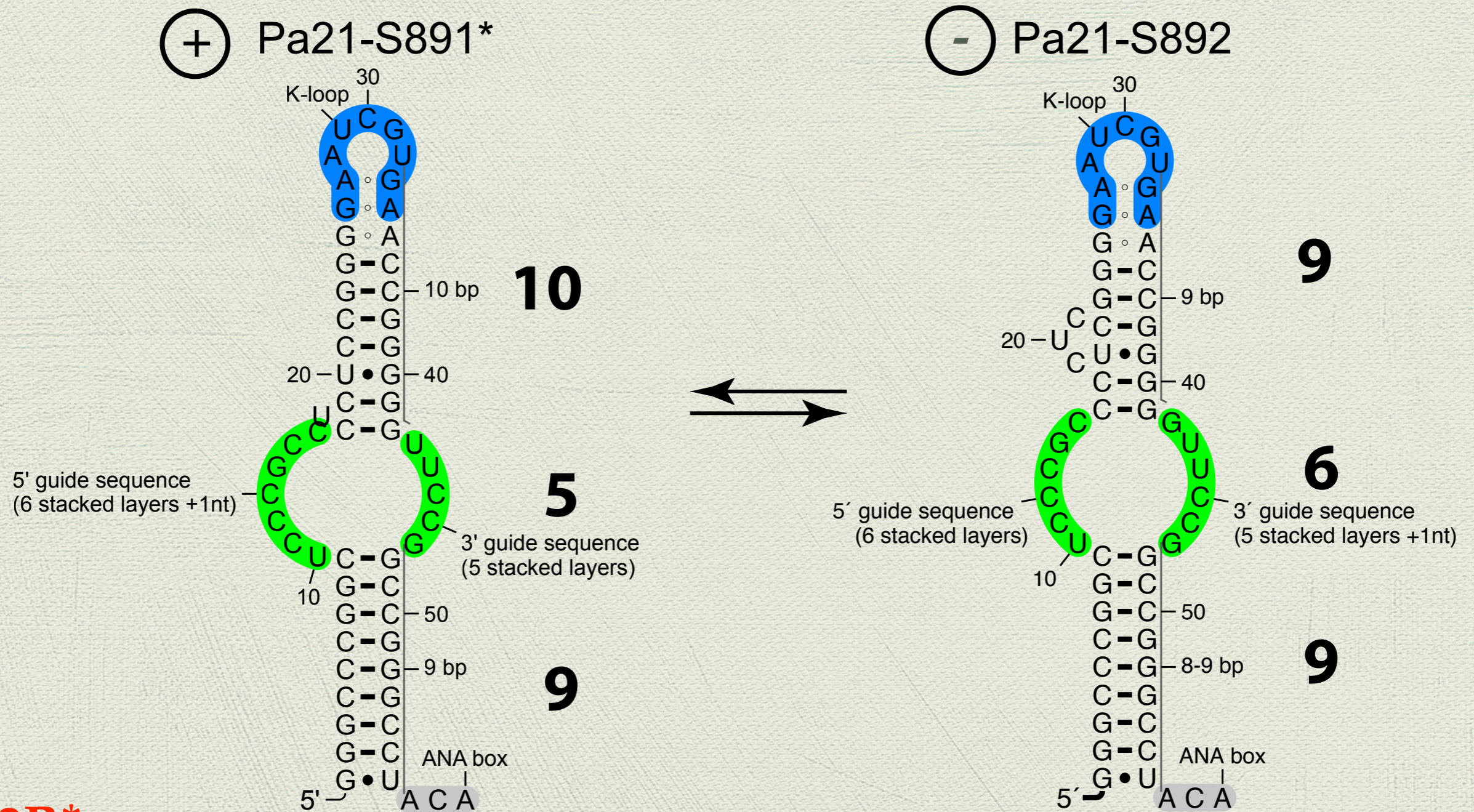

R2R*

Toffano-Nioche *et al.*, NAR, 2015

H/ACA « productifs »

Pa21-S891, Ph21-S879, Pf1-S879

Pa21-S891

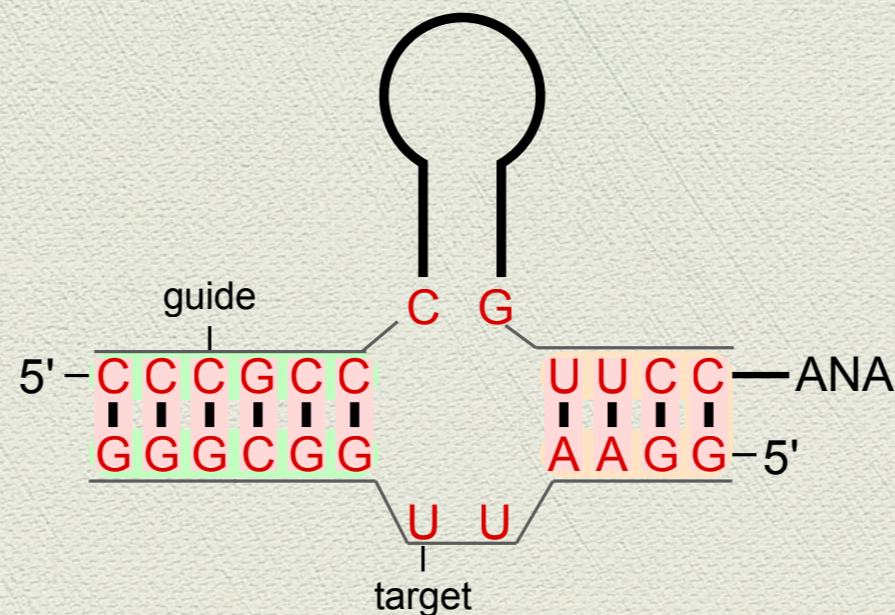
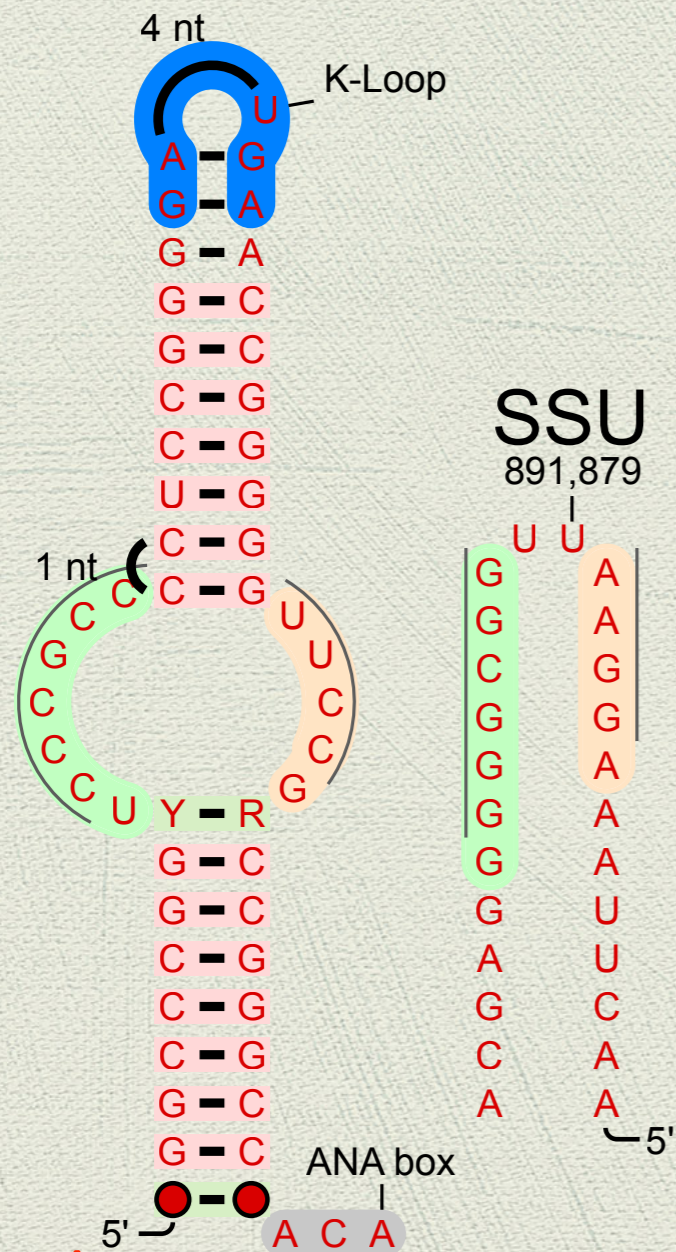

$$E = -28.2 \text{ kcal/mol}$$

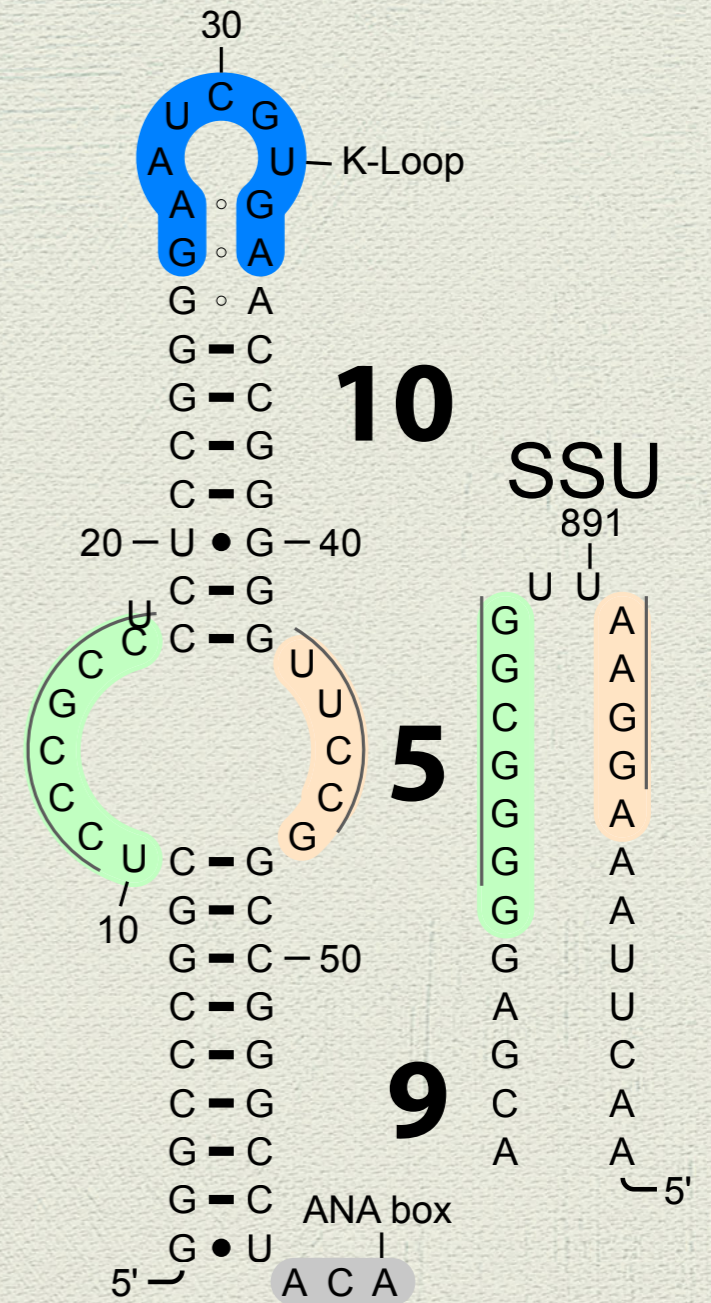

R2R*

Toffano-Nioche *et al.*, NAR, 2015

H/ACA « non-productifs »

Pa21-S892, Ph21-S880, Pf1-S880

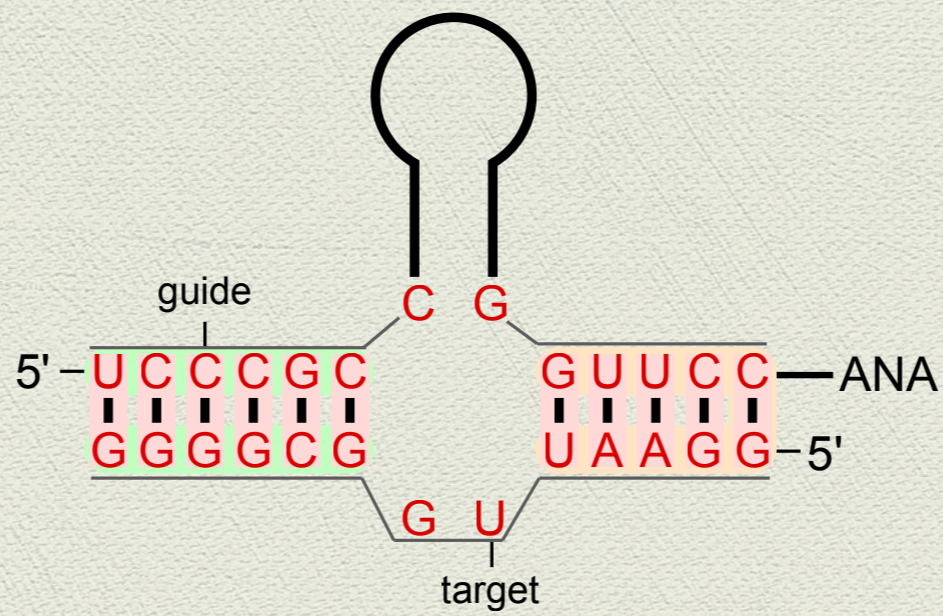
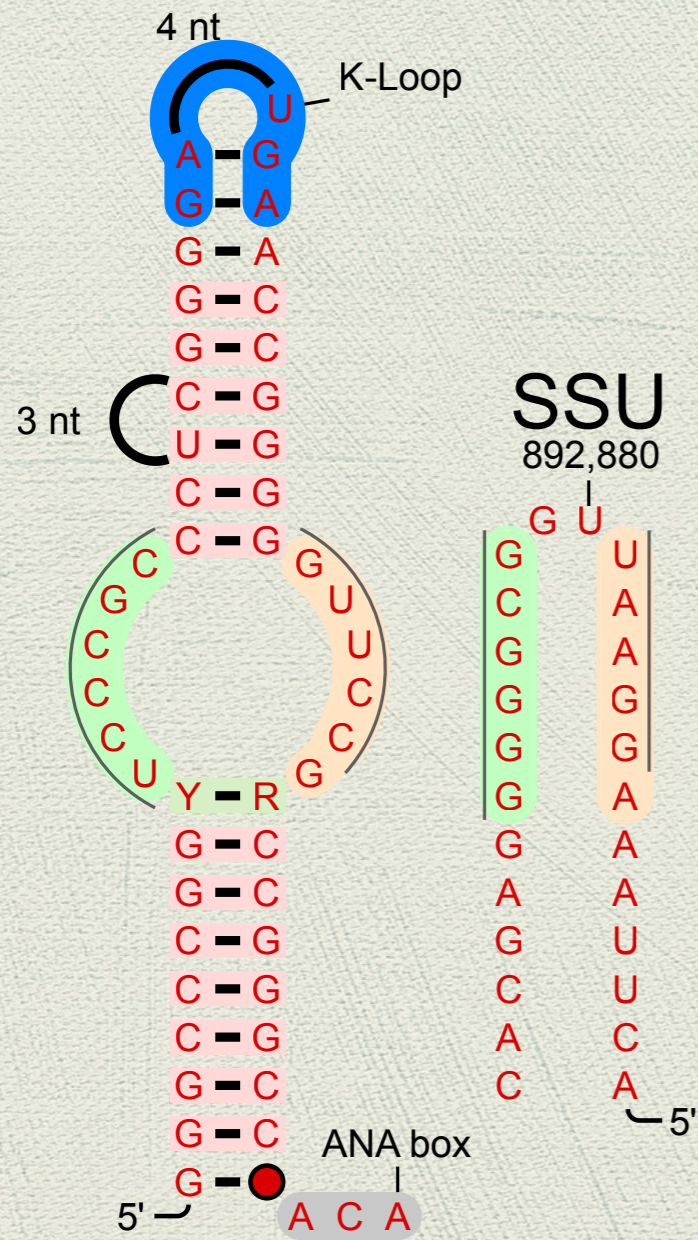

$E = -24.5 \text{ kcal/mol}$

Pa21-S892

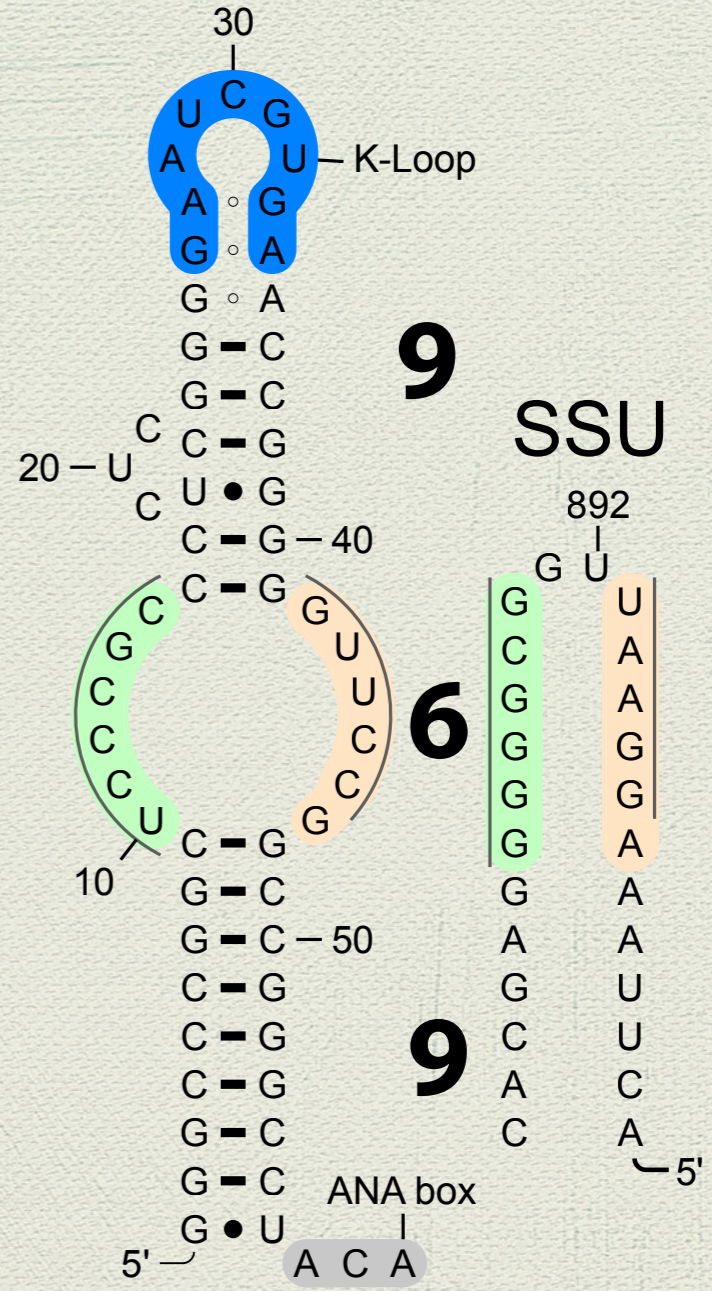

R2R*

Toffano-Nioche *et al.*, NAR, 2015

Familles H/ACA

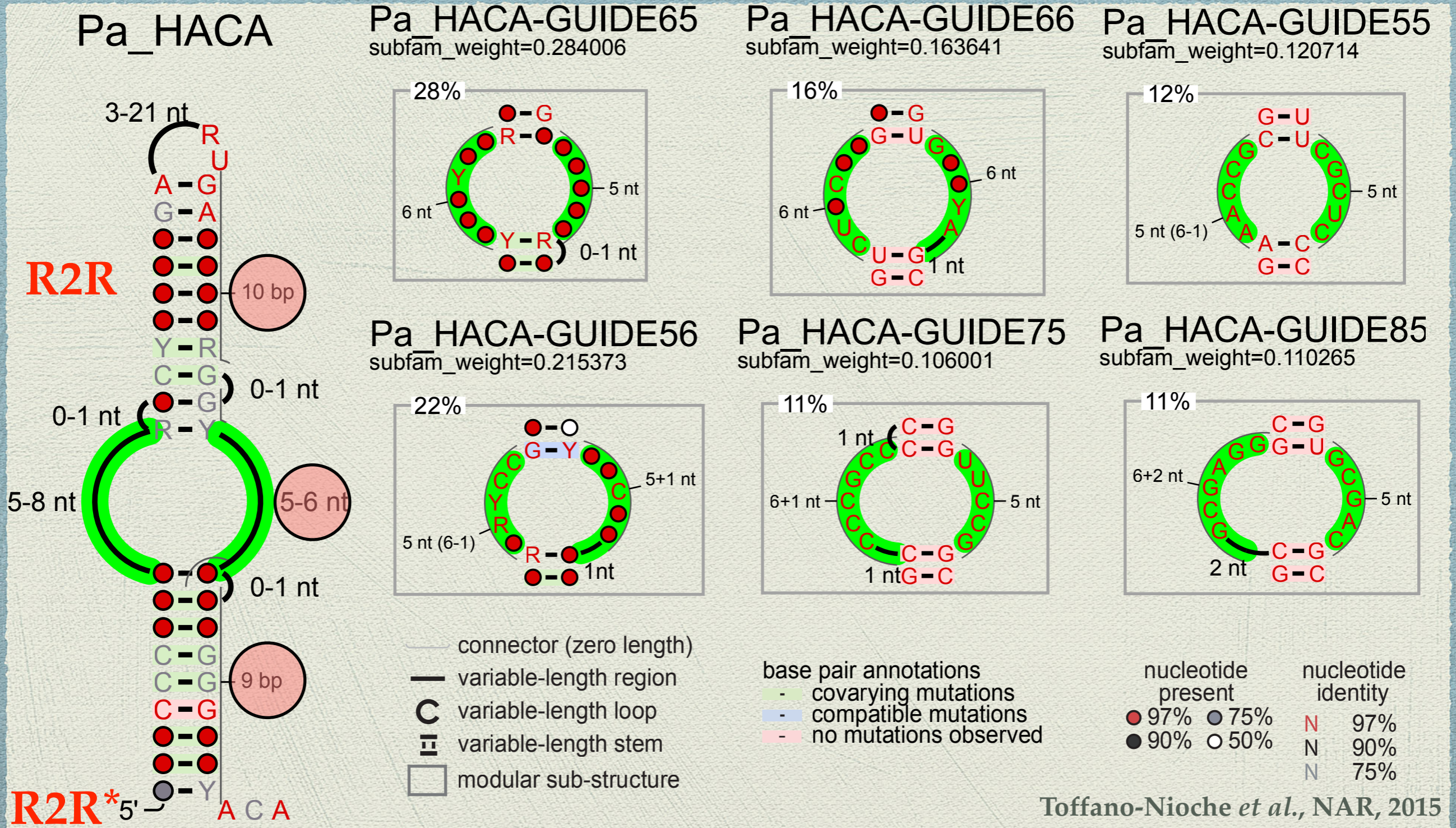

Toffano-Nioche *et al.*, NAR, 2015

Interactions intra-moléculaires

VARNA

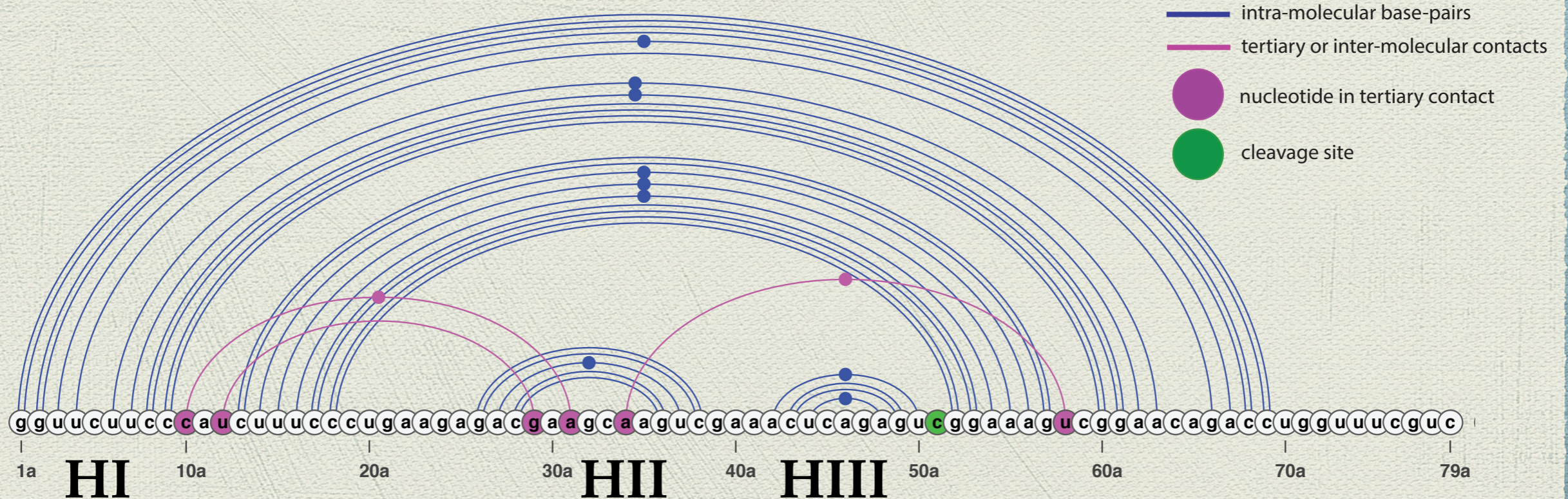
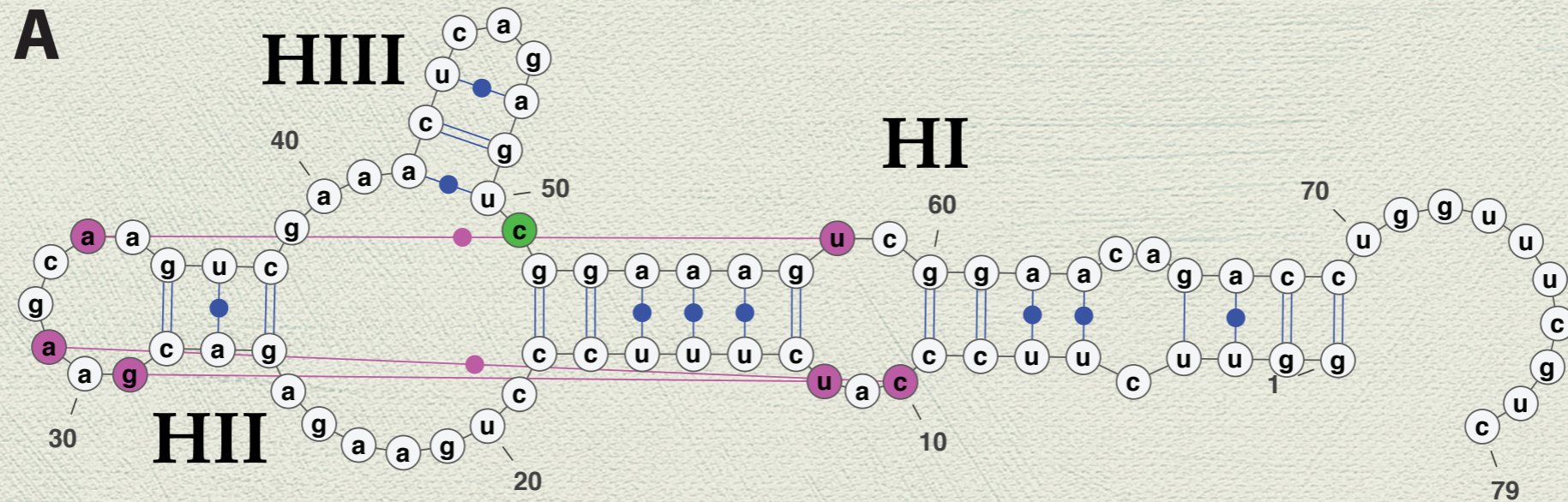

Interactions inter-moléculaires

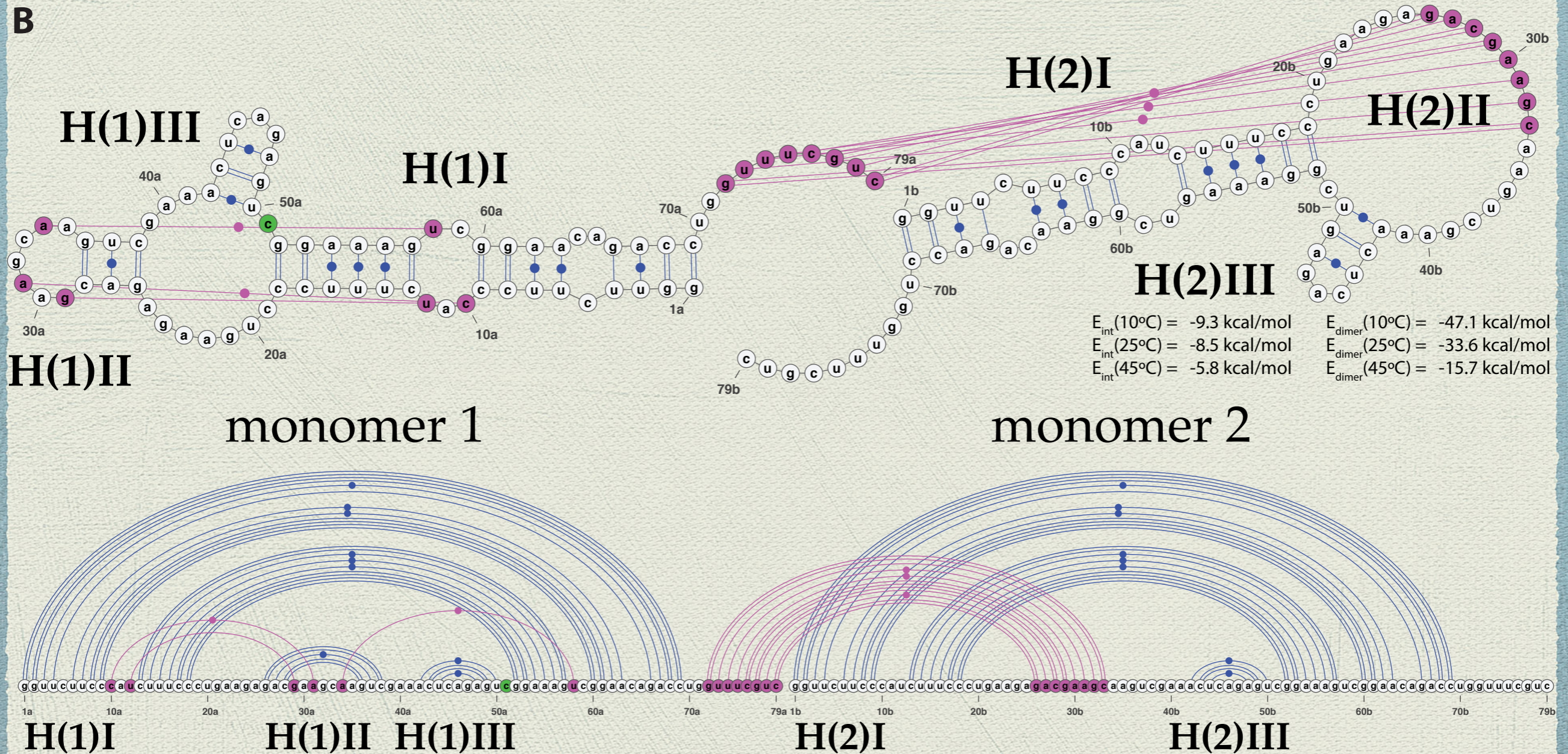

IntaRNA

Leclerc *et al.*, Sci. Rep., 2016

VARNA

Interactions inter-moléculaires

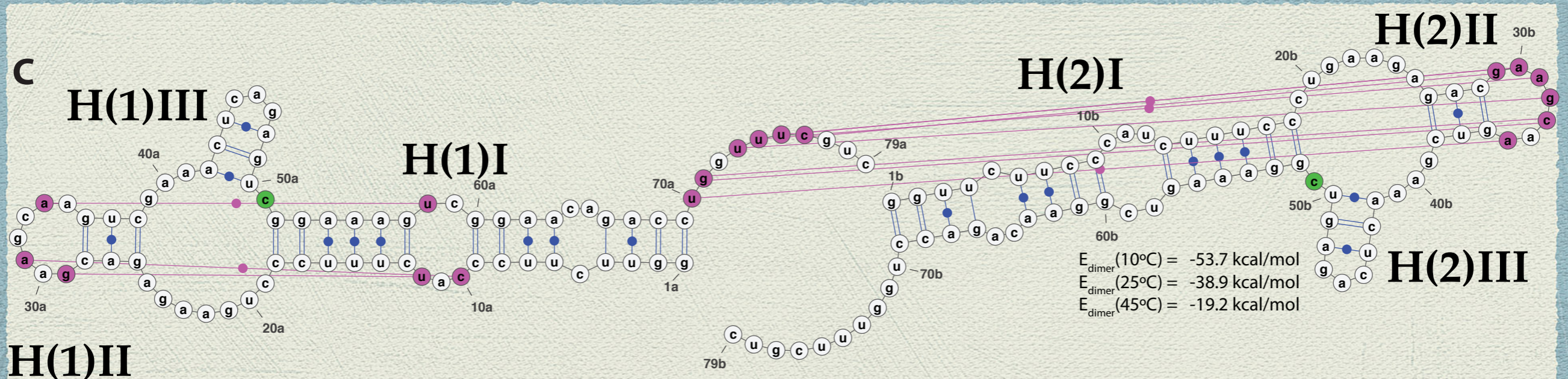

H(1)II

monomer 1

monomer 2

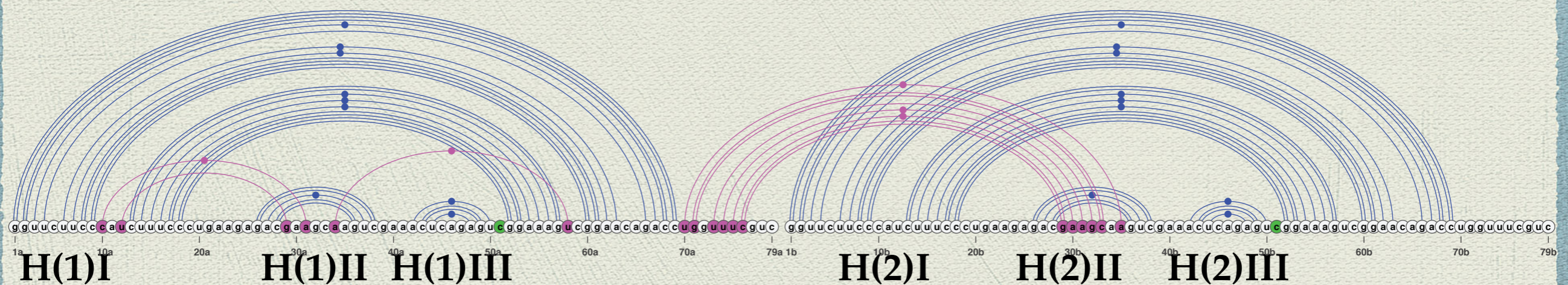

IntaRNA

Leclerc *et al.*, Sci. Rep., 2016

VARNA

Interactions inter-moléculaires

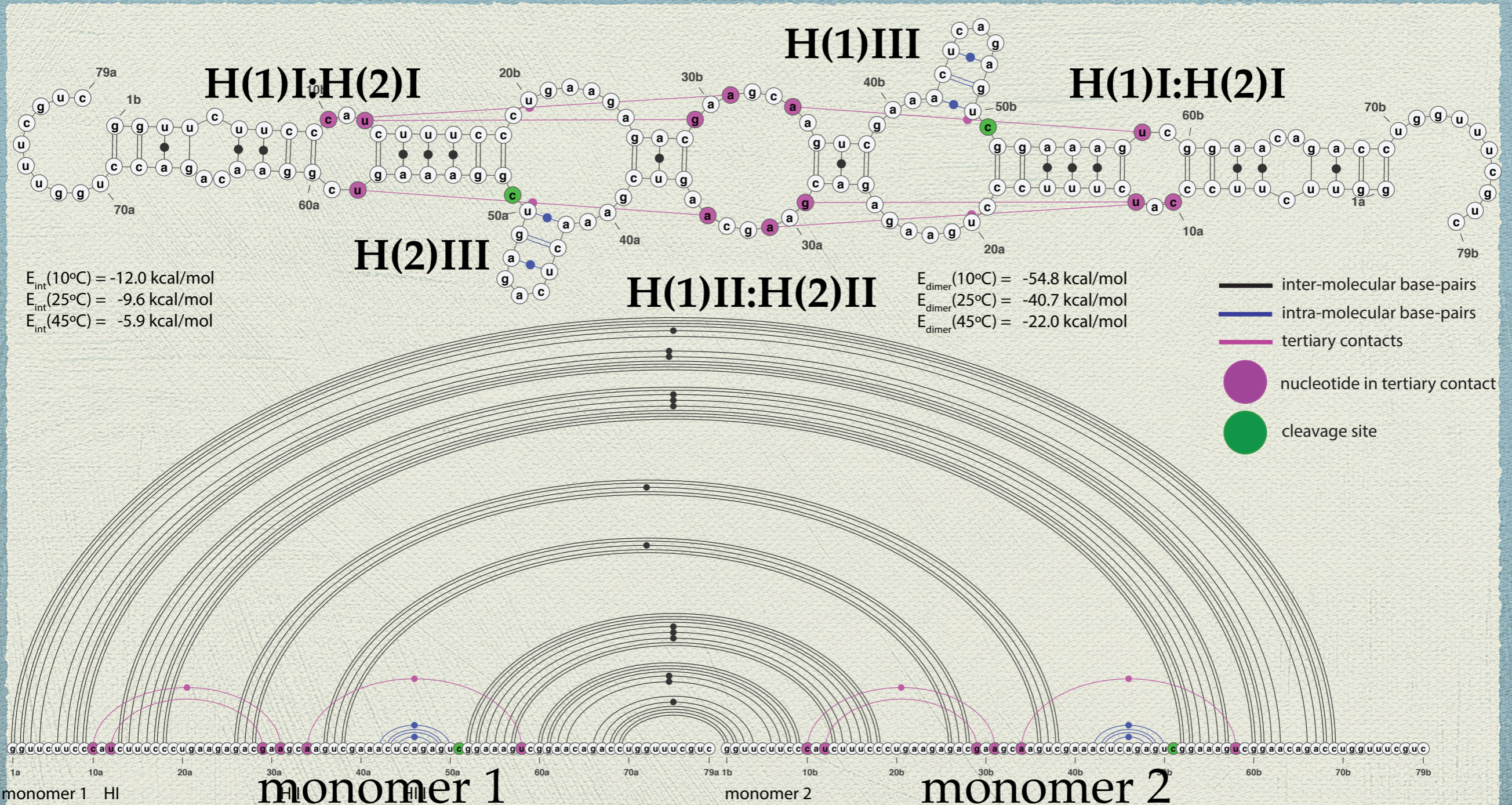

IntaRNA

Leclerc *et al.*, Sci. Rep., 2016

VARNA

Conclusions

- ◆ représentations standardisées et personnalisées (édition, annotation)
- ◆ gain de temps pour la génération de représentations multiples
- ◆ gain de temps pour la mise à jour de structures consensus
- ◆ outils qualitatif (quantitatif) pour évaluer des modèles structure-fonction

Outils & Ressources

- ◆ RFAM ([VARNA](#)), Comparative RNA Web Site & Project ([RNA2DMap](#), [CT](#), [BPSEQ](#)), The RNA Mapping Database - RMDB ([RDAT](#), [RNAstructure](#)), ...
- ◆ packages: Vienna Package ([RNAfold](#), [RNAalifold](#), etc), Boulder Alignment Editor ([VARNA](#)), SAVor ([RNAfold](#), [RNAplot](#)), S2S/Assemble 2D & 3D, Jalview 2D & 3D ([VARNA](#), [Jmol](#)), ...
- ◆ outils récents: long RNAs: [RNAfdl](#), pairing probabilities (alternative conformations): [RNAbow](#), [RNAAllViewer](#), ...

Références

- ◆ Ponty Y. & Leclerc F., Drawing and editing the Secondary Structures of RNA(s), *Methods in Molecular Biology*, 2015.
- ◆ Aigner K. et al., Chapitre 9. Visualizing RNA sequence and structure, 2011.

Acknowledgments



De la séquence au 2D

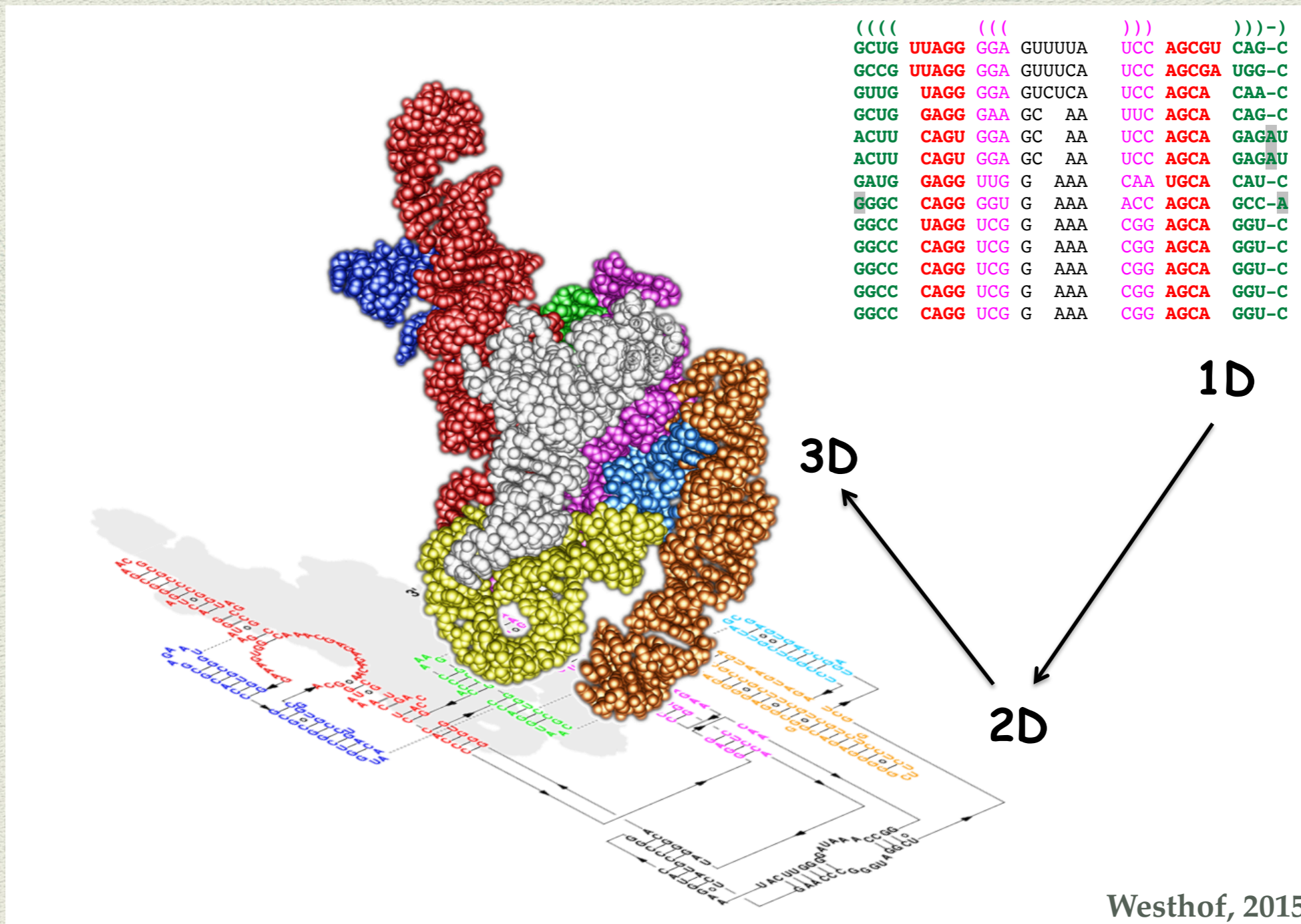

Westhof, 2015

De la structure 2D à 3D

- ◆ la structure 2D: une contrainte géométrique “forte”
- ◆ appariements non-canoniques et motifs
- ◆ pseudonœuds et interactions tertiaires

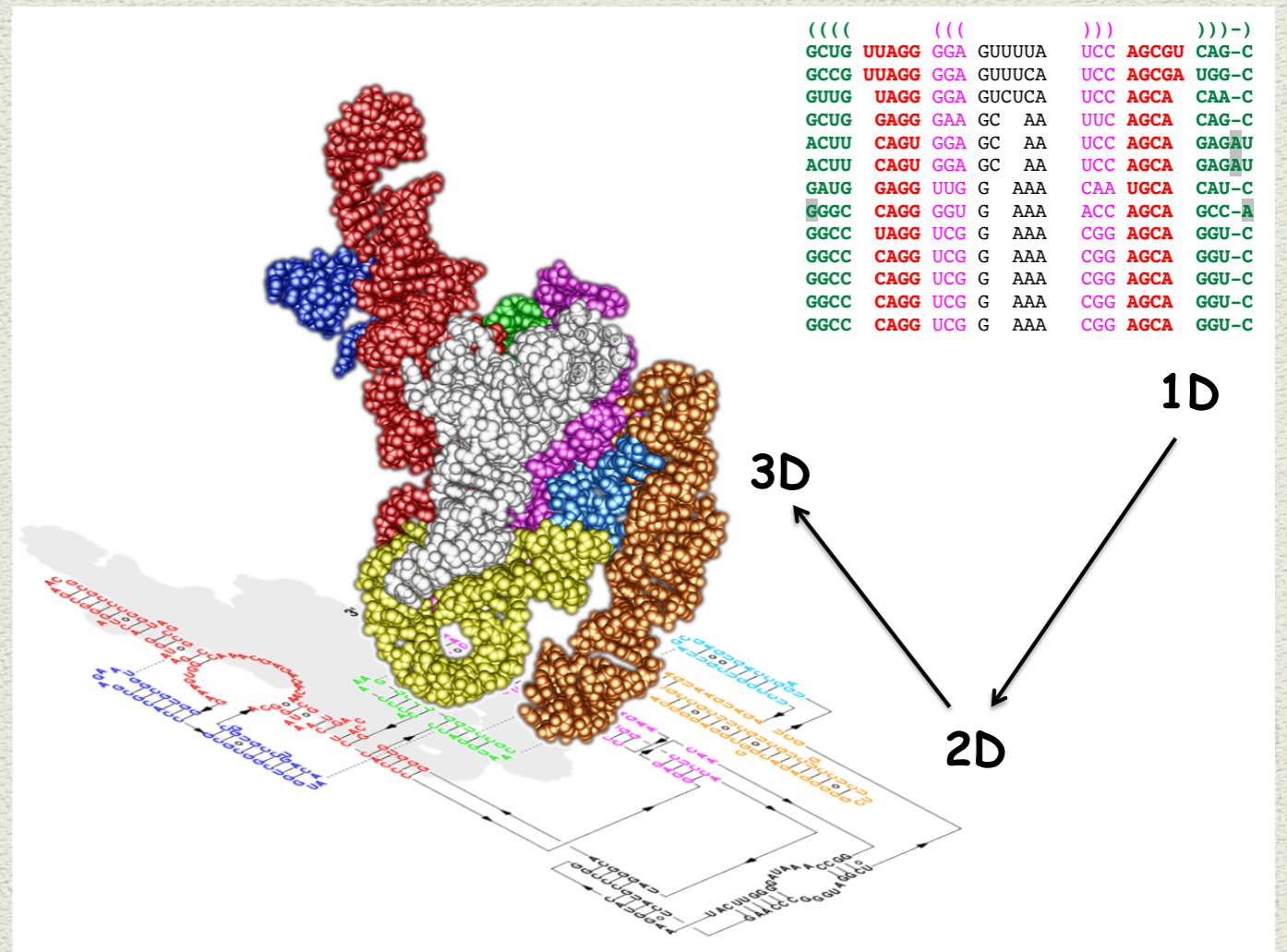

◆ ...

RNA Puzzles

- ◆ tester les capacités de prédiction de structures 3D d'ARN
- ◆ compétition entre modélisateurs ARN
- ◆ compétition à “l’aveugle”: structures 3D d'ARN non publiques

RNA Puzzle: T-Box / tRNA

- The T-box riboswitch in complex with tRNA

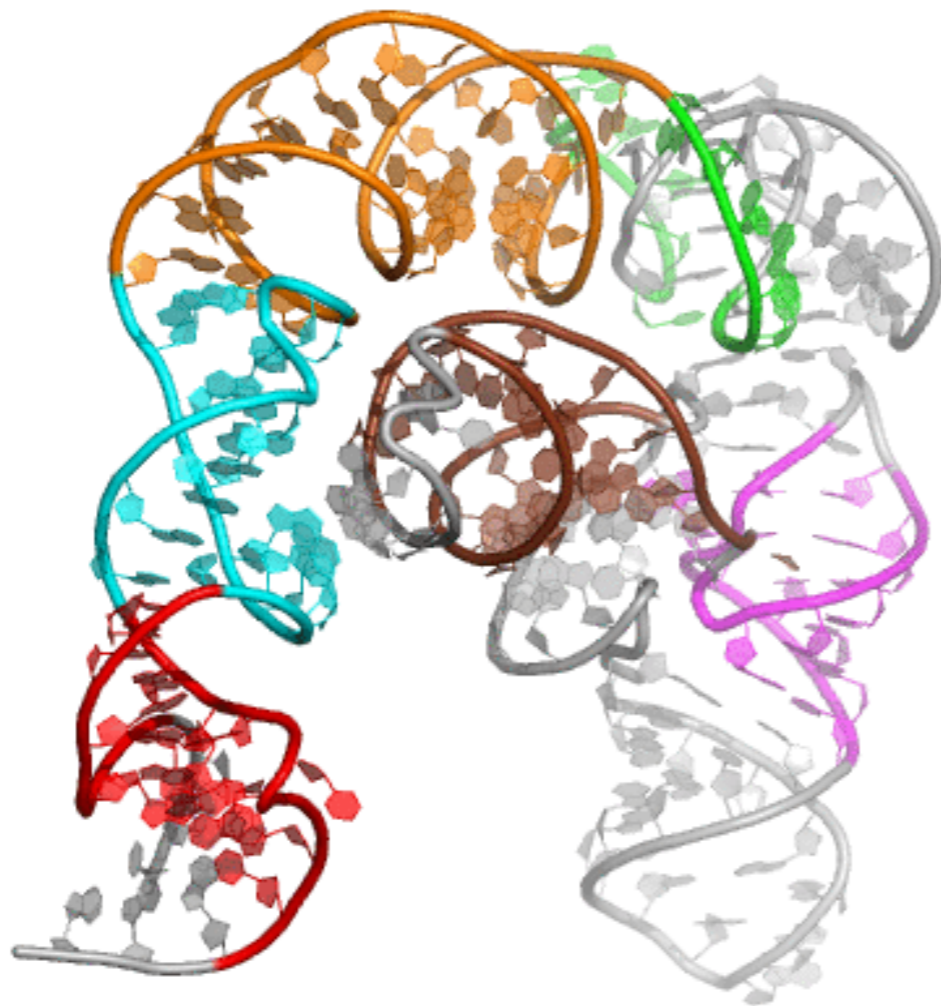

- PDB: 4LCK
- Resolution: 3.20Å
- Avg B = 128 Å²
- tRNA: 75nt
- T-box : 96nt
- Clash score: 2.28
- Some small fragments solved by NMR before. tRNA structure known.

RNA Puzzle: T-Box / tRNA

5.96

Group ^a	Number ^b	RMSD ^c	Rank ^d	DI all ^e	Rank ^d	INF all ^f	Rank ^d	INF wc ^g	Rank ^d	INF nwc ^h	Rank ^d	INF stack ⁱ	Rank ^d	Clash Score ^j	Rank ^d	MCCQ ^k	Rank ^d
Das	4	5.96	1	7.40	1	0.81	3	0.91	2	0.62	6	0.80	3	10.73	21	13.92	1
Das	3	6.51	2	8.18	2	0.80	5	0.90	4	0.65	4	0.79	9	11.09	24	15.39	5
Das	1	8.08	3	10.10	3	0.80	4	0.86	7	0.65	3	0.81	2	11.64	25	14.87	3
Das	5	9.32	4	11.24	4	0.83	1	0.91	3	0.74	1	0.82	1	10.91	22	15.08	4
Das	2	9.40	5	11.67	5	0.81	2	0.91	1	0.67	2	0.80	5	11.64	26	14.74	2
Bujnicki	4	10.62	6	16.64	15	0.64	20	0.81	20	0.00	25	0.64	18	0.91	2	21.77	21
Bujnicki	1	11.66	7	14.80	6	0.79	6	0.85	9	0.50	10	0.80	6	1.27	4	19.85	10
Bujnicki	8	11.69	8	14.86	7	0.79	7	0.85	10	0.56	8	0.79	7	1.45	7	18.32	6
Bujnicki	5	11.87	9	15.35	8	0.77	8	0.81	17	0.33	13	0.80	4	1.81	10	19.33	7
Bujnicki	7	11.88	10	16.14	14	0.74	14	0.81	18	0.30	14	0.75	14	1.45	6	20.07	11
Bujnicki	3	11.98	11	15.74	11	0.76	11	0.86	8	0.38	12	0.77	10	0.91	1	22.13	25
Bujnicki	6	12.00	12	15.95	13	0.75	13	0.79	24	0.17	15	0.79	8	1.27	5	19.46	8
Bujnicki	10	12.02	13	15.60	9	0.77	9	0.85	11	0.63	5	0.76	12	1.45	8	22.13	24
Bujnicki	9	12.02	14	15.83	12	0.76	12	0.81	19	0.59	7	0.76	13	0.91	3	20.43	12
Bujnicki	2	12.02	15	15.71	10	0.77	10	0.84	13	0.50	9	0.77	11	1.63	9	19.56	9
Dokholyan	2	12.29	16	19.44	18	0.63	23	0.80	22	0.00	17	0.62	20	8.89	16	20.90	14
Dokholyan	3	12.67	17	18.75	17	0.68	16	0.84	12	0.00	18	0.67	16	7.80	13	21.65	20
Chen	1	13.01	18	18.53	16	0.70	15	0.77	26	0.42	11	0.73	15	7.81	14	22.07	23
Dokholyan	8	13.22	19	21.39	20	0.62	24	0.83	14	0.00	23	0.59	25	8.71	15	21.63	19
Dokholyan	9	13.36	20	21.96	22	0.61	25	0.78	25	*	*	0.59	24	9.80	19	21.24	17
Dokholyan	10	13.47	21	20.90	19	0.65	19	0.88	6	0.00	24	0.61	22	10.16	20	21.98	22
Dokholyan	4	14.14	22	22.23	23	0.64	22	0.82	15	0.00	19	0.62	21	9.07	18	21.60	18
Dokholyan	1	14.42	23	21.93	21	0.66	17	0.80	21	0.00	16	0.66	17	11.07	23	20.92	15
Dokholyan	5	15.99	24	26.69	25	0.60	26	0.82	16	0.00	20	0.57	26	8.89	17	22.41	26
Dokholyan	7	16.87	25	26.47	24	0.64	21	0.79	23	0.00	22	0.64	19	6.35	11	20.64	13
Dokholyan	6	17.93	26	27.69	26	0.65	18	0.88	5	0.00	21	0.61	23	6.71	12	21.21	16
Mean		12.09		17.35		0.72		0.84		0.31		0.71		6.32		19.74	
Standard deviation		2.76		5.35		0.08		0.04		0.29		0.09		4.26		2.67	
														X-ray model			
														2.28			

RNA Puzzle: T-Box / tRNA

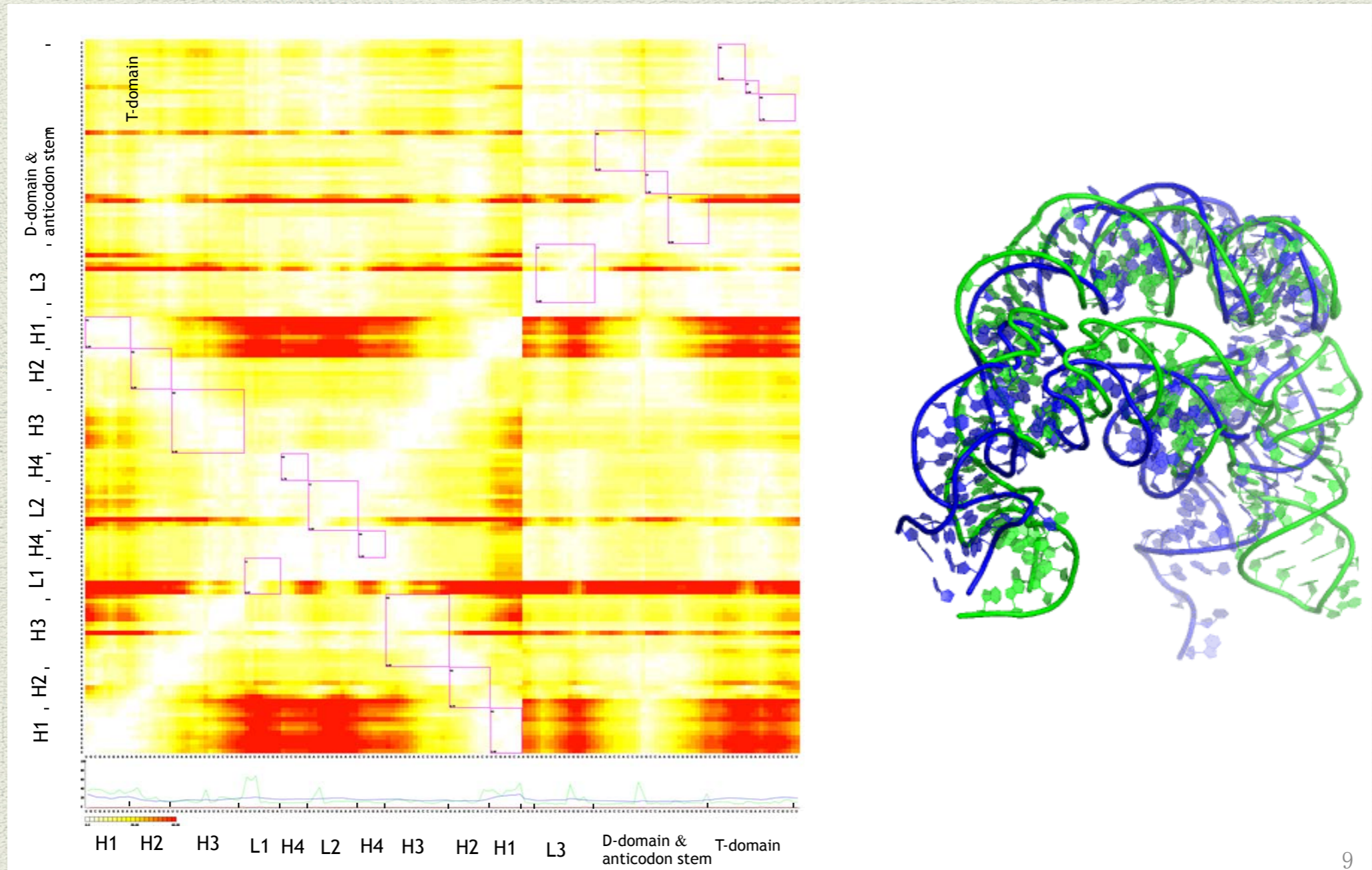

Table 1: Main tools offering a visualization of the RNA secondary structure.

Name	Platform(s) ^a [B/WML]	Ease of use Layouts	Interactivity	Pseudoknots	Ext. sec. str. ^b	Output ^c	Reference
jViz.RNA	●●●●	++ Circular Linear Graph	+	+	●	EPS PNG	(Wiese et al., 2005) (Shabash et al., 2012)
PseudoViewer	●●○○	++ Graph		++	○	EPS SVG PNG GIF	(Byun and Han, 2009)
RNA2DMap	●●●●	+ Graph	+	+	●	PDF^e	(Xu et al., 2011)
RNAMovies	●●●●	++ Graph		+	○	SVG PNG JPEG GIF	(Kaiser et al., 2007)
R-chie	●●●●	++ Linear		+	○	PDF PNG	(Lai et al., 2012)
RNAPLOT	● ^d ●●●	+ Graph			○	PS SVG GML	(Gruber et al., 2008)
RNAView	○●●●	+ Graph		+	●	PS	(Yang et al., 2003)
RNAViz	○●●●	+ Graph	++	+	○	PDF^e	(Rijk et al., 2003)
R2R	○●●●	- Graph		+	○	PDF SVG	(Weinberg and Breaker, 2011)
S2S/Assemble	○●●●	+ Linear Graph	++	+	●	SVG	(Jossinet and Westhof, 2005) (Jossinet et al., 2010)
VARNA	●●●●	++ Circular Linear Graph	++	+	●	EPS SVG PNG JPEG GIF	(Darty et al., 2009)
xRNA	○●●●	+ Graph	++	+	○	EPS	–

^a Indicates presence (●) or absence (○) for Browser-based, Windows, Mac and Linux executions, in this order. ^b Indicates support (●) or lack of support (○) for an extended secondary structure. ^c Bold output formats indicate vector graphics, allowing for convenient post-processing. ^d Only available from the Vienna RNA webserver, available at <http://rna.tbi.univie.ac.at/>. ^e Export accessible through a print option, using a custom printer driver such as Adobe Distiller.

Serveurs WEB généralistes:

ViennaRNA, BiBiServ, Freiburg RNA Tools

ViennaRNA Web Services

The ViennaRNA Web Services

This server provides programs, web services, and databases, related to our work on RNA secondary structures. For general information and other offerings from our group see the [main TBI web server](#).

Web Servers

Thermodynamic Structure Prediction

- **RNAfold server...**
...predicts minimum free energy structures and base pair probabilities from single RNA or DNA sequences.
- **RNAalifold server...**
...predicts *consensus* secondary structures from an alignment of several related RNA or DNA sequences. You need to upload an alignment.
- **RNAeval server...**
...provides a detailed thermodynamic description of a sequence/structure pair.
- **RNAcofold server...**
...allows you to predict the secondary structure of a dimer.
- **RNAup server...**
...allows you to predict the accessibility of a target region.

ncRNA Prediction

- **Structure conservation analysis server...**
...will assist you in detecting evolutionarily conserved RNA secondary structures in multiple sequence alignments.
- **RNAz server...**
...will assist you in detecting thermodynamically stable and evolutionarily conserved RNA secondary structures in multiple sequence alignments.
- **Bcheck...**
...predicts rnpB genes.
- **RNAstrand server...**
...allows you to predict the reading direction of evolutionarily conserved RNA secondary structures.

Folding Kinetics

- **barriers server...**
...allows you to get insights into RNA folding kinetics.

Sequence Design

- **RNAinverse server...**
...allows you to design RNA sequences for any desired target secondary structure.
- **RNAxs server...**
...assists you in siRNA design.

Genome Wide Screening

- **RNApredator...**
...predicts targets of small bacterial RNAs
- **TSSAR...**
...predicts bacterial Transcription Start Sites from dRNA-seq data.

RNAalifold

<http://rna.tbi.univie.ac.at>

Freiburg RNA Tools



Freiburg RNA Tools



Welcome

This web server provides online access to a series of tools developed by the [Freiburg Bioinformatics Group](#). To start using it, please select from the listings below, or use the menu on the left. If you prefer doing a local installation on your machine, please visit our [Download](#) section.

If you use our tools for research or education, please cite the corresponding articles from the [Publications](#) section.

Version 3.4.0

Freiburg RNA Tools

Freiburg RNA tools provides online access to a series of RNA research tools developed by the Freiburg Bioinformatics Group for sequence-structure alignments (LocARNA, CARNA, MARNA), clustering (ExpaRNA), interaction prediction (IntaRNA, CopraRNA), sequence design (INFORNA), CRISPR repeat analyses (CRISPRmap), and many more tasks.

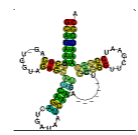

CopraRNA

CopraRNA is a tool for sRNA target prediction. It computes whole genome predictions by combination of whole genome IntaRNA predictions using homologous sRNA sequences from distinct organisms.



CRISPRmap

CRISPRmap provides a quick and detailed insight into repeat conservation and diversity of both bacterial and archaeal systems. It comprises the largest dataset of CRISPRs to date and enables comprehensive independent clustering analyses to determine conserved sequence families, potential structure motifs for endoribonucleases, and evolutionary relationships.

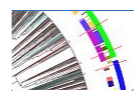

LocARNA

LocARNA computes multiple alignments of RNAs based on their sequence and structure similarity. In contrast to, e.g. MARNA, it considers the whole ensemble of secondary structures for each RNA. Thus, LocARNA aligns RNAs with unknown structure and predicts a consensus secondary structure for a set of unaligned RNAs. Specification of additional constraints or even enforcement of fixed input structures is possible. LocARNA is best suited to compare several (up to about 20) structural RNAs, in particular, of low sequence similarity.

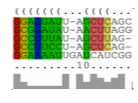

IntaRNA

IntaRNA enables the prediction of RNA-RNA interactions. It has been designed to predict mRNA target sites for given non-coding RNAs (ncRNAs) like eukaryotic microRNAs (miRNAs) or bacterial small RNAs (sRNAs), but it can also be used to predict other types of RNA-RNA interactions.

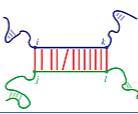

CARNA

Carna is a tool for multiple alignment of RNA molecules based on their full ensembles of structures. Carna computes the alignment that fits best to all likely structures simultaneously. Hence, Carna is in particular useful to align RNAs with more than one stable structure, as for example riboswitches, and is able to align arbitrary pseudoknots.

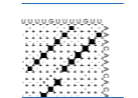

- Main Menu
- Home
- Publications
- Frequent Questions
- Help
- Download
- Results
 - Direct Access
- Freiburg RNA Tools
- CopraRNA
 - sRNA Targeting
- CRISPRmap
 - CRISPR Conservation
- LocARNA
 - Alignment & Folding
- IntaRNA
 - RNA-RNA interaction
- CARNA
 - Ensemble Alignment
- MARNA
 - Structure Alignment
- ExpaRNA
 - Exact Matching
- INFORNA
 - Sequence Design
- ModPepInt Server
- Domain Interaction
- CPSP-Tools
- Lattice Proteins
 - for the HP-model

IntaRNA

<http://rna.informatik.uni-freiburg.de:8080>

BiBiServ: Bielefeld Univ.

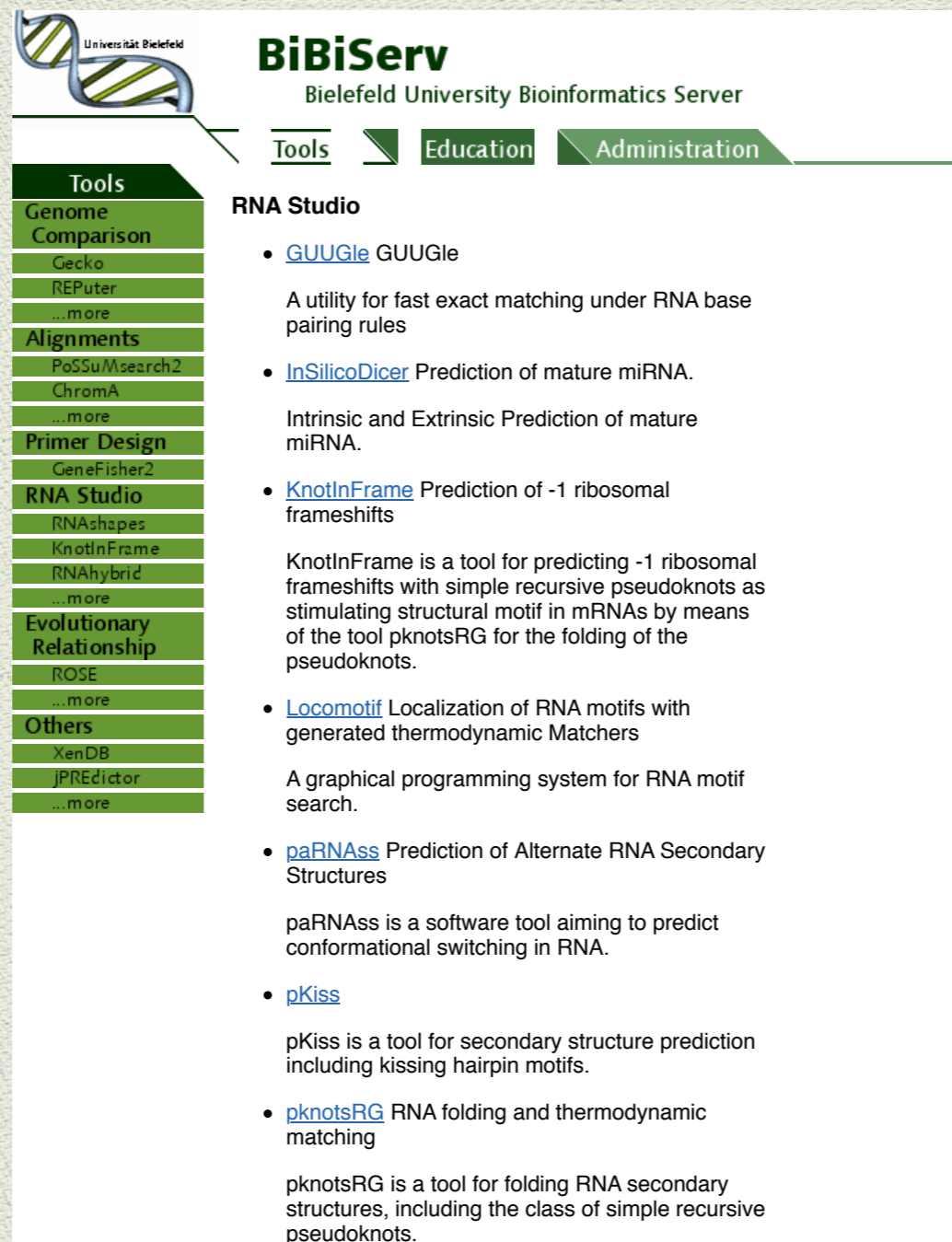

The screenshot shows the BiBiServ website interface. At the top left is the logo of Universität Bielefeld, a stylized DNA double helix. The main header reads "BiBiServ Bielefeld University Bioinformatics Server". Below the header are three navigation tabs: "Tools", "Education", and "Administration". The "Tools" tab is active, and a sidebar on the left lists various tool categories: "Genome Comparison" (with sub-items Gecko, REPuter, ...more), "Alignments" (with sub-items PoSSuMsearch2, ChromA, ...more), "Primer Design" (with sub-item GeneFisher2), "RNA Studio" (with sub-items RNAshapes, KnotInFrame, RNAhybrid, ...more), "Evolutionary Relationship" (with sub-item ROSE, ...more), and "Others" (with sub-items XenDB, JPREdicator, ...more). The "RNA Studio" section is expanded, showing a list of tools with their descriptions:

- GUUGle**: A utility for fast exact matching under RNA base pairing rules.
- InSilicoDicer**: Prediction of mature miRNA. Intrinsic and Extrinsic Prediction of mature miRNA.
- KnotInFrame**: Prediction of -1 ribosomal frameshifts. KnotInFrame is a tool for predicting -1 ribosomal frameshifts with simple recursive pseudoknots as stimulating structural motif in mRNAs by means of the tool pknotsRG for the folding of the pseudoknots.
- Locomotif**: Localization of RNA motifs with generated thermodynamic Matchers. A graphical programming system for RNA motif search.
- paRNAss**: Prediction of Alternate RNA Secondary Structures. paRNAss is a software tool aiming to predict conformational switching in RNA.
- pKiss**: pKiss is a tool for secondary structure prediction including kissing hairpin motifs.
- pknotsRG**: RNA folding and thermodynamic matching. pknotsRG is a tool for folding RNA secondary structures, including the class of simple recursive pseudoknots.

http://bibiserv.techfak.uni-bielefeld.de/bibi/Tools_RNA_Studio.html

ncRNA

Bioinformatics Tools and Databases for Functional RNA Analysis

ncRNA.org is the portal site for bioinformatics tools and databases specialized for functional RNAs. The developments in this site were partially supported by "The Functional RNA Project" funded by New Energy and Industrial Technology Development Organization (NEDO), Japan.

Now Available!

Results of various analysis on RNA secondary structures in one page!
Rtools

Accurate prediction of RNA secondary structure

CentroidFold

Prediction of RNA secondary structure by using homologous sequences

CentroidHomfold

Active Work Flow is available for RNA sequence/structure analysis.
You can download the Knime platform and the Active Work Flow for RNA structure predictions.

<http://www.ncrna.org>

CARNAC

RNA tools

DNA

YASS
Magnolia
mreps
ProCARs

HTS

SortMeRNA
CRAC
Vidjil
SToRM

RNA

Carnac
RNAfamily
Gardenia
Regliss
CG-seq
RNAspace

Proteins

Path
Protea
ReBLOSUM

TFM

TFM-Explorer
TFM-Scan
TFM-Pvalue
TFM-CUDA

NRP

Norine

The RNA tools offer a series of bioinformatics program specifically designed for the analysis of structural RNA: secondary structure inference, alignment, annotation, unaligned

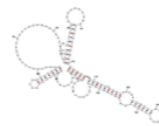
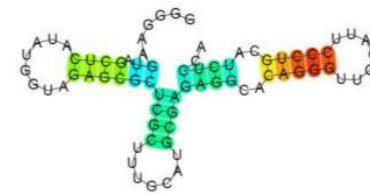

Carnac

Predicts the consensus secondary structure for a set of homologous, unaligned RNA sequences. Very fast and accurate.

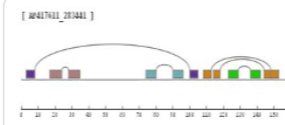

RNAfamily

Linear visualisation of RNA secondary structures

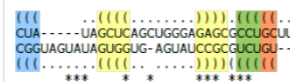

Gardenia

Comparison and multiple alignment of RNA sequences. The algorithm takes into account both the primary structure and the secondary structure to build a good alignment.

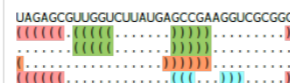

Regliss

This tool builds all locally optimal secondary structures of an RNA sequence, which provide a useful insight into the folding landscape of the molecule.



CG-seq

It is a software pipeline to identify noncoding RNA genes in genomic sequences by comparative analysis and multispecies comparison.

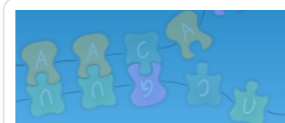

RNAspace

Annotation platform for noncoding RNAs

<http://bioinfo.lifl.fr/RNA/>

Seveurs WEB:

structures 2D conservées

RNAalifold (Vienna)

RNAalifold WebServer

1 Enter Input Parameters 2 View Results

[\[Home|New job|Help\]](#)

Welcome to the RNAalifold web server. It will predict a consensus secondary structure of a set of aligned sequences. Current limits are 3000 nt and 300 sequences for an alignment.



Simply paste or upload your alignment(s) below and click *Proceed*. Accepted alignment formats are CLUSTAL W and FASTA (will be detected automatically). To get more information on the meaning of the options click the  symbols. You can test the server using [this sample alignment](#).

Paste your alignment(s) here: [\[clear\]](#)





[▶ Show constraint folding](#)

Or upload a file: no file selected

RNAalifold version



- new RNAalifold with RIBOSUM scoring (Bernhart SH et al. 2008) 
- new RNAalifold (Bernhart SH et al. 2008) 
- old RNAalifold (Hofacker IL et al. 2002) 

Fold algorithms and basic options

- minimum free energy (MFE) and partition function 
- minimum free energy (MFE) only 
- output "most informative sequence" instead of simple consensus 
- no GU pairs at the end of helices 
- avoid isolated base pairs 

[▶ Show advanced options](#)

Output options

- interactive RNA secondary structure plot 
- RNA secondary structure plots with reliability annotation (Partition function folding only) 
- Mountain plot 

Notification via e-mail upon completion of the job (optional):

RNAfold

RNAfold WebServer

1 Enter Input Parameters

2 View Results

[\[Home\]](#) [\[New job\]](#) [\[Help\]](#)

The **RNAfold web server** will predict secondary structures of single stranded RNA or DNA sequences. Current limits are 7,500 nt for partition function calculations and 10,000 nt for minimum free energy only predictions.

Simply paste or upload your sequence below and click *Proceed*. To get more information on the meaning of the options click the  symbols. You can test the server using [this sample sequence](#).





Paste or type your **sequence** here:

[\[clear\]](#)

 [Show constraint folding](#)



Or upload a file in FASTA format: no file selected

Fold algorithms and basic options

- minimum free energy (MFE) and partition function 
- minimum free energy (MFE) only 
- no GU pairs at the end of helices 
- avoid isolated base pairs 

 [Show advanced options](#)

Output options

- interactive RNA secondary structure plot 
- RNA secondary structure plots with reliability annotation (Partition function folding only) 
- Mountain plot 

RNAfold

<http://rna.tbi.univie.ac.at/cgi-bin/RNAfold.cgi>

RNAz

Standard Analysis

Welcome to the RNAz web server. It will help you to detect thermodynamically stable and evolutionarily conserved RNA secondary structures in multiple sequence alignments.

Genomic Screen

Simply paste or upload your alignment(s) below and click *Proceed*. The system will suggest reasonable default values for all options. To get more information on the meaning of the options click the  symbols or read the [help pages](#). You can test the server using [this sample alignment](#).

Help

If you like to analyze alignments covering whole genomic regions use the *Genomic screen* modus.

Paste your alignment(s) here: 

[\[clear\]](#)

Or upload a file: 

no file selected

Format: 

▾

Institute for Theoretical Chemistry | University of Vienna | rna@tbi.univie.ac.at

RNAz <http://rna.tbi.univie.ac.at/cgi-bin/RNAz/RNAz.cgi>

Banques de données

Rfam

[HOME](#) | [SEARCH](#) | [BROWSE](#) |
[FTP](#) | [BLOG](#) | [HELP](#)

keyword search

Go

Rfam 12.0 (July 2014, 2450 families)

The Rfam database is a collection of RNA families, each represented by **multiple sequence alignments**, **consensus secondary structures** and **covariance models (CMs)**. [More...](#)

QUICK LINKS

[SEQUENCE SEARCH](#)
[VIEW AN RFAM FAMILY](#)
[VIEW AN RFAM CLAN](#)
[KEYWORD SEARCH](#)
[TAXONOMY SEARCH](#)

JUMP TO

YOU CAN FIND DATA IN RFAM IN VARIOUS WAYS...

Analyze your RNA sequence for Rfam matches
View Rfam family annotation and alignments
View Rfam clan details
Query Rfam by keywords
Fetch families or sequences by NCBI taxonomy

Go

Example

Enter any type of accession or ID to jump to the page for a Rfam family, sequence or genome

Or view the [help](#) pages for more information

Recent Rfam [blog](#) posts

Hide this

[Rfam 12.0 is out](#) (posted 24 September 2014)

We are pleased to announce the release of Rfam 12.0! This release contains some major changes when compared with previous releases of Rfam, so please take a minute to read our release notes. Rfam 12.0 is the first version of Rfam which is based on Infernal 1.1, and as such contains many significant changes. In [...]

<http://rfam.xfam.org>

Rfam entry RF00065

<http://rfam.xfam.org>

Family: *snoR9* (RF00065) Description: *Small nucleolar RNA snoR9*

12 sequences 0 species 0 structures

Summary

Summary

Sequences

Alignment

Secondary structure

Species

Trees

Structures

Motif matches

Database references

Curation

Jump to...

enter ID/acc

Go

Wikipedia annotation [Edit Wikipedia article](#)

The Rfam group coordinates the annotation of Rfam families in [Wikipedia](#). This family is described by a Wikipedia entry entitled **Small nucleolar RNA snoR9**. You can see the Wikipedia page for this family [here](#). [More...](#)

snoR9 is a [non-coding RNA](#) (ncRNA) which functions in the biogenesis (modification) of other small nuclear RNAs (snRNAs). It is known as a [small nucleolar RNA](#) (snoRNA) and also often referred to as a 'guide RNA'.

R9 is a member of the [C/D box](#) class of snoRNAs which contain the conserved sequence motifs known as the C box (UGAUGA) and the D box (CUGA). Most of the members of the box C/D family function in directing site-specific 2'-O-methylation of substrate RNAs ^[1]

This snoRNA was identified in a computational search for GC-rich regions in the AT-rich genomes of [hyperthermophiles](#) ^[2] This snoRNA is not related to the plant snoRNA [snoR9](#).

References[[edit](#)]

- [^] Galardi, S.; Fatica, A.; Bachi, A.; Scaloni, A.; Presutti, C.; Bozzoni, I. (October 2002). "Purified Box C/D snoRNPs Are Able to Reproduce Site-Specific 2'-O-Methylation of Target RNA in Vitro". *Molecular and Cellular Biology* **22** (19): 6663–6668. doi:10.1128/MCB.22.19.6663-6668.2002. PMC 134041. PMID 12215523. [edit](#)
- [^] Klein RJ, Misulovin Z, Eddy SR (2002). "Noncoding RNA genes identified in AT-rich hyperthermophiles". *Proc. Natl. Acad. Sci. U.S.A.* **99** (11): 7542–7. doi:10.1073/pnas.112063799. PMC 124278. PMID 12032319.

External links[[edit](#)]

- Page for Small nucleolar RNA snoR9 at Rfam



This [molecular](#) or [cell biology](#) article is a [stub](#). You can help Wikipedia by [expanding it](#).

Small nucleolar RNA snoR9

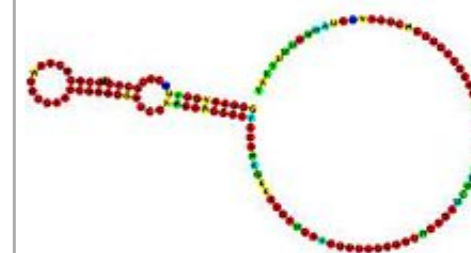

Sequence conservation

Predicted [secondary structure](#) and [sequence conservation](#) of snoR9

Identifiers

Symbol	snoR9
Rfam	RF00065
Other data	
RNA type	Gene; snRNA; snoRNA; CD-box
Domain(s)	Archaea
GO	0006396 0005730
SO	0000593

This page is based on a [wikipedia article](#). The text is available under the [Creative Commons Attribution/Share-Alike License](#).

Pseudobase

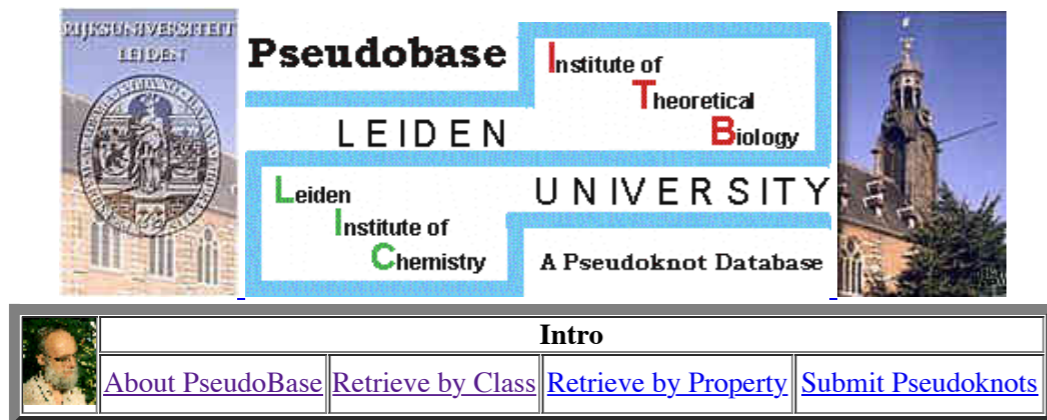



The logo for Pseudobase features the text "Pseudobase" in a large, bold font, with "LEIDEN" underneath. To the right, it says "Institute of Theoretical Biology" and "Leiden Institute of Chemistry". Below this, it reads "UNIVERSITY" and "A Pseudoknot Database". A small portrait of a man is visible on the left side of the navigation menu.

Intro

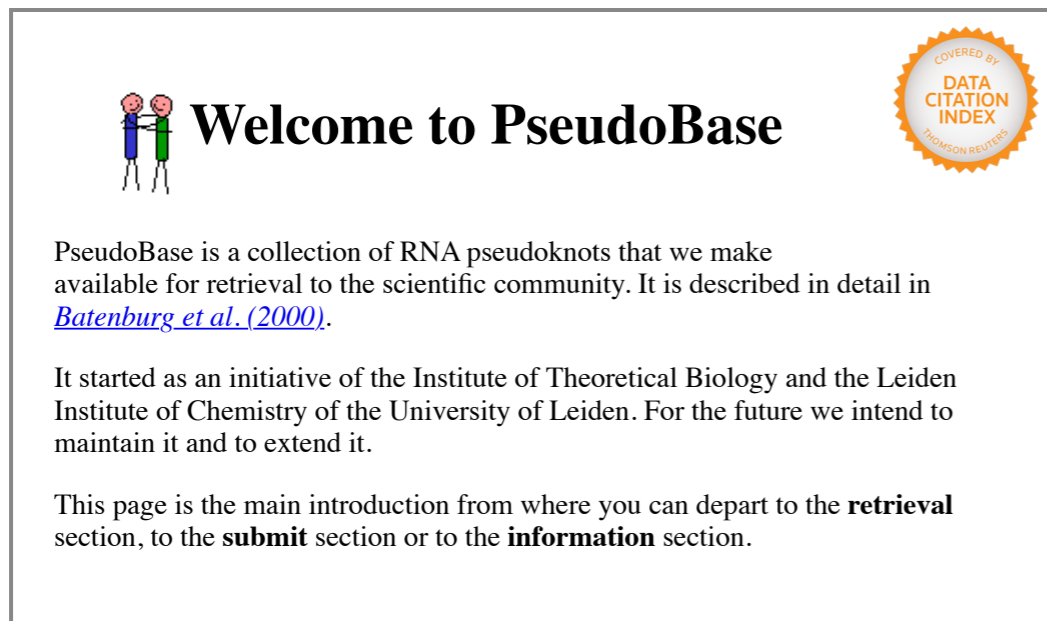
[About PseudoBase](#) [Retrieve by Class](#) [Retrieve by Property](#) [Submit Pseudoknots](#)



 **Welcome to PseudoBase**



PseudoBase is a collection of RNA pseudoknots that we make available for retrieval to the scientific community. It is described in detail in [Batenburg et al. \(2000\)](#).

It started as an initiative of the Institute of Theoretical Biology and the Leiden Institute of Chemistry of the University of Leiden. For the future we intend to maintain it and to extend it.

This page is the main introduction from where you can depart to the **retrieval** section, to the **submit** section or to the **information** section.



Retrieve, Submit or more Info?

Please choose whether you want to retrieve a pseudoknot or submit a pseudoknot. If you need more information, you can choose the "About PseudoBase" option.

[About PseudoBase](#)

Choose this option if you want to contact us, or if you need more information about us and about the PseudoBase project.

Retrieve pseudoknot [by class](#) or [by summary](#)

Choose either of these options to retrieve a particular pseudoknot. The "by class" page presents all pseudoknots organised by their class. The "by summary" page presents all pseudoknots in a table that you can sort to your taste. Sorting criteria are among others: class, name, organism and length of pseudoknot stems and loops.

[Submit a new pseudoknot to PseudoBase](#)

Choose this option for the section where you can submit a pseudoknot.



Contact: EkevanBatenburg@live.com

Prototyping: Jacky Ng & Jan Oliehoek.

© final design and maintenance: F.H.D.(Eke) van Batenburg, 1998-12-18;...; 11/30/2014 19:30:25.

<http://www.ekevanbatenburg.nl/PKBASE/>

RNAcentral

<http://rnacentral.org>

RNAcentral is a new resource that provides unified access to the ncRNA sequence data supplied by the Expert Databases. [Learn more \(/about-us\)](#)



[\(/expert-database/ena\)](#)
ENA provides a comprehensive record of the world's nucleotide sequencing information.
6,989,739 sequences
(example [\(/rna/URS00002D0E0C\)](#)))

[Explore ENA entries \(/expert-database/ena\)](#)



[\(/expert-database/rfam\)](#)
Rfam is a database containing information about ncRNA families and other structured RNA elements.
2,493,782 sequences
(example [\(/rna/URS00000478B7\)](#)))

[Explore Rfam entries \(/expert-database/rfam\)](#)



[\(/expert-database/refseq\)](#)

RefSeq is a comprehensive, integrated, non-redundant, well-annotated set of reference sequences.
30,900 sequences
(example [\(/rna/URS000075A3E5\)](#)))

[Explore RefSeq entries \(/expert-database/refseq\)](#)



[\(/expert-database/vega\)](#)

Vega is a repository for high-quality gene models produced by the manual annotation of vertebrate genomes. Human and mouse data from Vega are merged into GENCODE.
28,640 sequences
(example [\(/rna/URS00000B15DA\)](#)))

[Explore Vega entries \(/expert-database/vega\)](#)



[\(/expert-database/gtrnadb\)](#)

gtRNAdb contains tRNA gene predictions on complete or nearly complete genomes.
10,625 sequences
(example [\(/rna/URS000047C79B\)](#)))

[Explore gtRNAdb entries \(/expert-database/gtrnadb\)](#)



[\(/expert-database/mirbase\)](#)

miRBase is a database of published miRNA sequences and annotations that provides a centralised system for assigning names to miRNA genes.
8,795 sequences
(example [\(/rna/URS00000A685\)](#)))

[Explore miRBase entries \(/expert-database/mirbase\)](#)



[\(/expert-database/rdp\)](#)

RDP provides quality-controlled, aligned and annotated rRNA sequences and a suite of analysis tools.
4,779 sequences
(example [\(/rna/URS000064300F\)](#)))

[Explore RDP entries \(/expert-database/rdp\)](#)



[\(/expert-database/tmrna-website\)](#)

tmRNA Website contains predicted tmRNA sequences from RefSeq prokaryotic genomes, plasmids and phages.
2,857 sequences
(example [\(/rna/URS000060F5B3\)](#)))

[Explore tmRNA Website entries \(/expert-database/tmrna-website\)](#)



[\(/expert-](#)

[database/srpdb\)](#)

SRPDB provides aligned, annotated and phylogenetically ordered sequences related to structure and function of SRP.
503 sequences
(example [\(/rna/URS00000478B7\)](#)))

[Explore SRPDB entries \(/expert-database/srpdb\)](#)



[\(/expert-database/Incrnadb\)](#)

IncrNAdb is a database providing comprehensive annotations of eukaryotic long non-coding RNAs (lncRNAs).
62 sequences
(example [\(/rna/URS00000478B7\)](#)))

[Explore IncrNAdb entries \(/expert-database/Incrnadb\)](#)

Comparative RNA Web Site

 THE UNIVERSITY OF TEXAS AT AUSTIN

COMPARATIVE RNA WEB SITE AND PROJECT **THE GUTELL LAB**

Welcome to the Comparative RNA Web (CRW) Site.

Recent CRW Site Publications
([Complete List »](#))

2014: (Pub #129) Multiple entries in: Concise Encyclopaedia of Bioinformatics and Computational Biology, 2nd Edition, Hancock J.M. and Zvelebil M.J. (eds.). Wiley. Hoboken, New Jersey.

2014: (Pub #128) Ten Lessons with Carl Woese about RNA and Comparative Analysis. *RNA Biology*, in press.
[[PM](#) | [pmc](#) | [DOI](#)]

2014: (Pub #127) Introduction to Special Carl Woese Issue in *RNA Biology*. *RNA Biology*, 11(3):170-171. [[pm](#) | [pmc](#) | [DOI](#)]

2014: (Pub #126) Helix Capping in RNA Structure. *PLOS One*, 9(4):e93664. [[PM](#) | [PMC](#) | [DOI](#)]

2013: (Pub #125) [Two Accurate Sequence, Structure, and Phylogenetic Template-Based RNA Alignment Systems](#). *BMC Systems Biology*, 7(S4):S13. [[pm](#) | [pmc](#) | [DOI](#)]

2013: (Pub #124) [You tell Carl that some of my best friends are Eukaryotes: Carl R. Woese \(1928-2012\)](#). *RNA* 19(4):vii-xi.
[[pm](#) | [pmc](#) | [doi](#)]

2013: (Pub #123) Specificity between Lactobacilli and Hymenoptera Hosts is the Exception Rather than the Rule. *Applied and Environmental Microbiology*, 79:1803-1812. [[PM](#) | [pmc](#) | [DOI](#)]

2013: (Pub #122) Comparative Analysis of the Higher-Order Structure of RNA. In: [Biophysics of RNA Folding](#) ("Biophysics for the Life Sciences" Series). pp. 11-22. Springer, New York, NY. [[pm](#) | [pmc](#) | [DOI](#)]

2012: (Pub #121) [An Accurate Scalable Template-based Alignment Algorithm](#). *Proceedings of 2012 IEEE International Conference on Bioinformatics and Biomedicine (BIBM 2012)*, Philadelphia, PA. October 4-7, 2012. pp. 237-243.
[[PM](#) | [PMC](#) | [DOI](#)]

2012: (Pub #120) [The Fragmented Mitochondrial Ribosomal RNAs of Plasmodium falciparum](#). *PLoS One*, 7(6):e38320.
[[PM](#) | [PMC](#) | [DOI](#)]

2012: (Pub #119) [Structural Constraints Identified with Covariation Analysis in Ribosomal RNA](#). *PLoS One*, 7(6):e39383.
[[PM](#) | [PMC](#) | [DOI](#)]

2012: (Pub #118) [A Comparison of the Crystal Structures of the Eukaryotic and Bacterial SSU Ribosomal RNAs Reveals Common Structural Features in the Hypervariable Regions](#). *PLoS One*, 7(5):e38203. [[PM](#) | [PMC](#) | [DOI](#)]

2011: (Pub #117) [rCAD: A Novel Database Schema for the Comparative Analysis of RNA](#). 7th IEEE International Conference on e-Science, Stockholm, Sweden. December 5-8, 2011. pp. 15-22. [[PM](#) | [PMC](#) | [DOI](#)]

<http://www.rna.icmb.utexas.edu>

Serveur d'annotation d'ARNnc

RNASpace

Home

1. Load data

2. Predict

3. Explore

HELP

Welcome to RNASpace

RNASpace is a platform which aims at providing an integrated environment for non-coding RNA annotation.

The increasing number of ncRNA discovered since 2000 and the lack of user friendly tools for finding and annotating them, have made necessary to propose to biologists an *in silico* environment allowing structural and functional annotations of these molecules with regard to available protein genes annotation environments.

RNASpace makes available a variety of [ncRNA gene finders](#) and [ncRNA databases](#) as well as user-friendly tools to explore computed results including comparison, visualization and edition of putative RNAs. RNASpace also allows to export putative RNAs in various [formats](#).



Partners



FAQ



Contact

News

June 28, 2013 The site is now running on a new and more powerful computer environment provided by the Genotoul Bioinformatics platform with a reduced list of Infernal models.

RNASpace software v1.2.1 (July 28, 2011) is running this site.

Availability

RNASpace is an open source project. It is developed in Python. It is copyrighted with the GNU General Public License, and is free (in the GNU sense) for all to use, and is in constant development. RNASpace is hosted at [Sourceforge](#). It is also available as a web server at [rnaspace.org](#).



Comments and remarks: contact@rnaspace.org.

<http://www.rnaspace.org>

Autres outils: représentation

VARNA

VARNA: Visualization Applet for RNA

A Java lightweight component and applet for drawing the RNA secondary structure

[Home](#)

[Demo](#)

[User Manual](#)

[Tutorials](#)

[Downloads](#)

[Java Security Fix](#)

[Links](#)

Announcement

VARNA 3.91 released
08/09/2014
Bulging loops, angular hysteresis...

Support



Recent changes in Java security policy might prevent you from running VARNA.
[Check out this page for details and ways to solve the problem.](#)

What VARNA is

Description

VARNA is Java lightweight Applet dedicated to **drawing the secondary structure of RNA**. It is also a Swing component that can be very easily included in an existing Java code working with RNA secondary structure to provide a fast and interactive visualization.

Being **free of fancy external library dependency** and/or network access, the VARNA Applet can be used as a base for a standalone applet. It looks reasonably good and **scales up or down nicely** to adapt to the space available on a web page, thanks to the anti-aliasing drawing primitives of Swing.

Motivation

The initial version was coded after several unfruitful attempts at finding a RNA secondary structure drawing software to be used inside of a webserver. Indeed, it seemed at the time that most of the webserver dedicated to the secondary structure of RNA offered rather clumsy renderings (Mostly *static*, cgi-bin generated, PS or PNG files).

In 2008, I ([Yann Ponty](#)) was unable to find a tool that would be at the same time available, easy to install and still running ([SStructView](#) was no longer tolerated by latest Java plugins security policies; [RNAMLView](#)'s goal was rather to display a projection of the 3D structure, and [RNAMovies](#) was more tailored towards animations...). Therefore, I coded a basic software *from scratch*, initially using a *radial* layout strategy adopted by the software [RNAViz](#), later to be extended to other classic algorithms such that [NAView](#), a classic *Feynman-diagram* representation and a linear one, hoping it would be useful to some... VARNA development team was subsequently joined by Kevin Darty and [Alain Denise](#) ([LRI/IGM-Orsay-France](#)) in 2009, leading to a complete redesign of the software.

As of November 2012, VARNA is currently used by RNA scientists and websites such as the [NestedAlign](#) web server, the [IRESite](#) database ([Example](#)), and the [TFold](#) webserver.

[Biogeeks](#) also features (featured?) a very nice tutorial showing how to use VARNA as a front end to [RNAFold](#) through a minimal Ruby script.

Credits/License/Disclaimer

If you find VARNA useful to your research, please contribute to its continued development by citing its [supporting manuscript](#):

VARNA: Interactive drawing and editing of the RNA secondary structure
Kévin Darty, Alain Denise and Yann Ponty
Bioinformatics, pp. 1974-1975, Vol. 25, no. 15, 2009

<http://varna.lri.fr>

R-Chie

R-chie [arči]

A web server and R package for plotting arc diagrams of RNA secondary structures

- [Home \(index.cgi\)](#)
- [Create a Plot \(plot.cgi\)](#)
- [FAQ \(faq.cgi\)](#)
- [Citation \(cite.cgi\)](#)
- [Download \(download.cgi\)](#)
- [Rfam Gallery \(rfam.cgi\)](#)

R-chie allows you to make arc diagrams of RNA secondary structures, allowing for easy comparison and overlap of two structures, rank and display basepairs in colour and to also visualize corresponding multiple sequence alignments and co-variation information.

R4RNA is the R package powering R-chie, available for [download \(download.cgi\)](#) and local use for more customized figures and scripting.

Available types of plots (click to load example input to web form)

[Single Structure \(plot.cgi?eg=single\)](#)

[Double Structures \(plot.cgi?eg=double\)](#)

[Overlapping Structures \(plot.cgi?eg=overlap\)](#)

[Single Covariance \(plot.cgi?eg=singlecov\)](#)

[Double Covariance \(plot.cgi?eg=doublecov\)](#)

[Overlapping Covariance \(plot.cgi?eg=overlapcov\)](#)

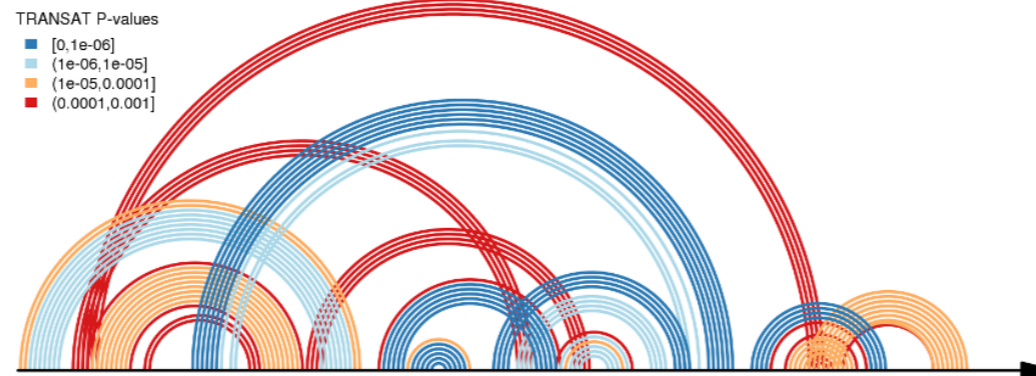

[\(plot.cgi?eg=single\)](#)

Visualize complicated basepairing as arcs on a linear sequence, colouring basepairs by value.

e.g. [TRANSAT \(cite.cgi\)](#) basepairs predictions for the Cripavirus internal ribosomal entry site (IRES), RF00458, coloured by p-value.

<http://www.e-rna.org/r-chie/plot.cgi>

RILogo

RILogo - web server

Submit

Help & Download

RILogo creates RNA-RNA interaction logos for two RNAs. The input are either two single sequences or two multiple sequence alignments with annotation of intra- or intermolecular base pairing between the two RNAs. RILogo displays sequence conservation by a sequence logo for each RNA and structure conservation by the mutual information of the secondary structure base pairings. RILogo supports four different methods for calculating the mutual information.

See the [Help page](#) for input formats and examples. RILogo is free of charge and also available for [download](#) as an open source standalone program.

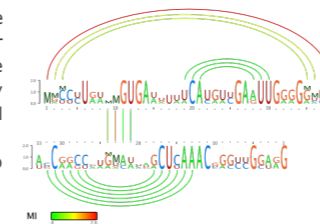

Submit

Please fill out the submission form and click the Submit button. Input fields marked with a * are required. ([Load Example Data](#))

Multiple Sequence Alignment*

Enter your multiple sequence alignment with structure annotation here. Either use the text area or upload a file.

Supported formats are Stockholm, Clustal or Fasta.

In Clustal and Fasta format, the secondary structure annotation must have the sequence name *structure*.

The alignment can also contain both interacting RNAs.

In that case, both sequences belonging to one species must be separated by the '&' character. [\[?\]](#)

Upload alignment file: no file selected

2nd Multiple Sequence Alignment

If the first alignment contains only one RNA, then insert the second alignment here. Either use the text area or upload a file. [\[?\]](#)

Upload alignment file: no file selected

Mutual Information measure:

RILogo implements four different measures for the mutual information of base pairs.

Please refer to the paper for the exact definitions. [\[?\]](#)

<http://rth.dk/resources/rilogo/submit>

RNAfdl

RNAfdl

Description ▾ Downloads (/projects/sfnet_rnafdl/releases/)

SourceForge.net page (<http://sourceforge.net/projects/rnafdl>)

Project Description

[Review this project](#)

[RSS \(http://sourceforge.jp/projects/sfnet_rnafdl/releases/rss/\)](http://sourceforge.jp/projects/sfnet_rnafdl/releases/rss/)

 [Image list \(/projects/sfnet_rnafdl/images/\)](/projects/sfnet_rnafdl/images/)

RNAfdl is a highly flexible tool for drawing RNA secondary structures. Secondary structures can be visualized as classical secondary structure plot, circle plot, linear plot or mountain plot. RNAfdl allows manual editing and several drawing styles, as well as a fully automated conjugate gradients minimization approach to draw more complex structures without user interaction. In addition, RNAfdl allows you to incorporate non-canonical base pairs into drawings.

[Write Howto Install \(/projects/sfnet_rnafdl/howto/install\)](/projects/sfnet_rnafdl/howto/install)

[Write Howto Use \(/projects/sfnet_rnafdl/howto/usage\)](/projects/sfnet_rnafdl/howto/usage)

(This Description is auto-translated) [Try to translate to Japanese \(/projects/sfnet_rnafdl/translate/\)](/projects/sfnet_rnafdl/translate/) [Show Original Description](#)

Download

Latest Files

[RNAfdl-1.08.tar.gz \(/projects/sfnet_rnafdl/downloads/RNAfdl-1.08.tar.gz/\)](/projects/sfnet_rnafdl/downloads/RNAfdl-1.08.tar.gz) (Date: 2014-08-19, Size: 871.0 KB)

[RNAfdl-1.07.tar.gz \(/projects/sfnet_rnafdl/downloads/RNAfdl-1.07.tar.gz/\)](/projects/sfnet_rnafdl/downloads/RNAfdl-1.07.tar.gz) (Date: 2014-08-07, Size: 895.8 KB)

[RNAfdl-1.06.tar.gz \(/projects/sfnet_rnafdl/downloads/RNAfdl-1.06.tar.gz/\)](/projects/sfnet_rnafdl/downloads/RNAfdl-1.06.tar.gz) (Date: 2014-08-02, Size: 900.7 KB)

[RNAfdl-1.05.tar.gz \(/projects/sfnet_rnafdl/downloads/RNAfdl-1.05.tar.gz/\)](/projects/sfnet_rnafdl/downloads/RNAfdl-1.05.tar.gz) (Date: 2014-01-01, Size: 763.7 KB)

[RNAfdl-1.04.tar.gz \(/projects/sfnet_rnafdl/downloads/RNAfdl-1.04.tar.gz/\)](/projects/sfnet_rnafdl/downloads/RNAfdl-1.04.tar.gz) (Date: 2013-08-20, Size: 760.7 KB)



[Download File List \(/projects/sfnet_rnafdl/releases/\)](/projects/sfnet_rnafdl/releases/)

http://en.sourceforge.jp/projects/sfnet_rnafdl/

RnaViz



Welcome to the homepage of RnaViz

[Documentation](#) [Guided tour](#) [Binary distributions](#) [Source distribution](#)

Latest News

2013 Dec.: an easier binary distribution is available (this includes all dependencies)

What is RnaViz

RnaViz is a user-friendly, portable, GUI program for producing publication-quality secondary structure drawings of RNA molecules. Drawings can be created starting from [DCSE](#) alignment files if they incorporate structure information or from mfold ct files. The layout of a structure can be changed easily. Display of special structural elements such as pseudo-knots or unformatted areas is possible. Sequences can be automatically numbered, and several other types of labels can be used to annotate particular bases or areas. Although the program does not try to produce an initially non-overlapping drawing, the layout of a properly positioned structure drawing can be applied to newly created drawing using skeleton files. In this way a range of similar structures can be drawn with a minimum of effort. Skeletons for several types of RNA molecule are included with the program.

Some of the features

- recognises ct, naml and DCSE alignment formats
- multiple structures on page
- simple but powerfull WYSIWYG editing using different selection modes
- skeletons to easily draw many structure using the same layout
- allows display of pseudoknots
- free choice of fonts, colors, linewidths for any object
- graphica objects for annotation (rectangle, oval, lines, text)
- linking of graphics, text to certain bases
- tag based changing of properties
- automatic sequence numbering
- zoom
- independend scaling of structure drawings
- portable

<http://rnaviz.sourceforge.net>

Autres outils: prédictions

RNA Tools

RNA TOOLS: RNAbows, BINDIGO, and PSR



[RNAbows](#) present intuitive visualization of RNA base pairing probabilities.

BINDING
| | | | |
OLIGO

[BINDIGO](#) is a new, faster algorithm to calculating optimal binding of oligometric RNA to an RNA target.

PRIMARY
SEQUENCE
RANK



RRREEE
AANN
PSQIMUCKY

[PSR](#) is an algorithm for efficiently discriminating donor splice sites from decoy sequences.

[Aalberts Homepage](#)
E-mail: aalberts@williams.edu

<http://rna.williams.edu>

RNAbows

We offer three types of RNAbows for visualizing partition function computations.



Base pairs are denoted by arcs whose thickness and shade is proportional to their probability.



After splitting the partition function, the two dominant clusters of folds are compared.



Highlights differences between the folds of two sequences of the same length.

<http://rna.williams.edu/rnabows/>

RNAmutants

RNAmutants

Home
News
Download
Webserver
FAQs
Tutorial
References
Contact

Exploring the effects of mutations on the secondary structure of RNAs

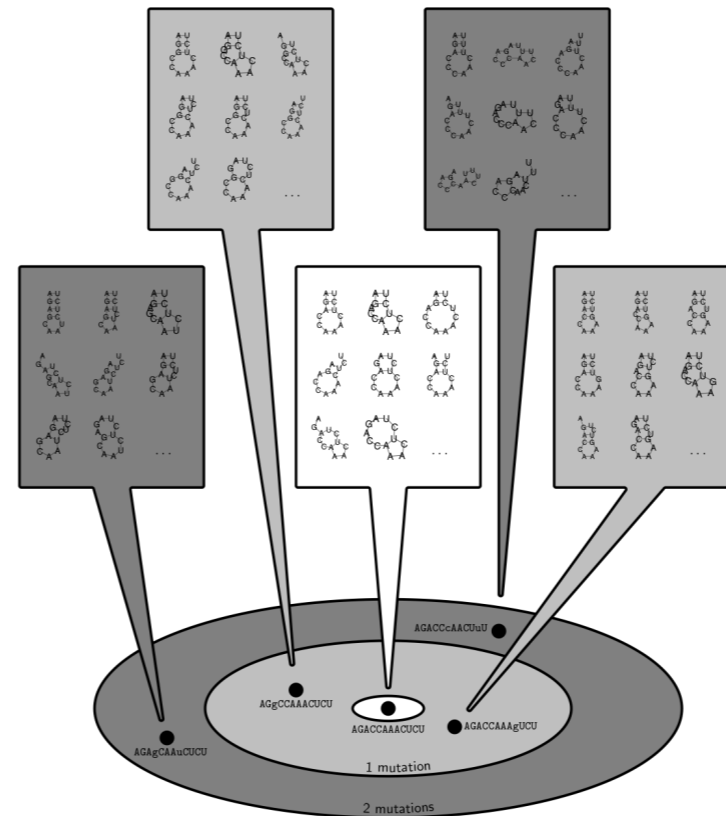

Keywords: thermostability, beneficial and deleterious mutations, thermodynamic pressure, RNA design, evolution.

More details? Visit the FAQs.

<http://rnamutants.csail.mit.edu>

Autres outils: 2D & 3D

Structures 2D & 3D

The screenshot displays the S2S (Sequence to Structure) software interface. On the left, a 3D ribbon model of an RNA structure is shown in purple and orange. The main window is divided into several panels:

- 1: 2D Explorer:** Shows a sequence alignment of six sequences (S1-S6) with a secondary structure diagram below it. The alignment is as follows:

1	10	20	30	40
S1	GGAGUUCACCGAGGCCACGCGGAGUACG	AUCGAGGGUACAGUGAAUU		
S2	GAUGCCGAGGCCACGCCGGUAGGAUCGAGGGUACAGCAUC			
S3	AAUCCCGAGGCCACGCCGAGUAGGAUCGAGGGUACAGGAUU			
S4	GAAGCCGCGGCCACGCCGAGUAGGAACGAGGGUACAGCUUC			
S5	CUCGCCGAGGCCACGCCGAGUAGGACCGAGGGUACAGCGAG			
S6	AGUGCCGGGCCACGCCGAGUACGAUCGAGGGUACAGCACU			
- 2DViewer:** Shows a detailed 2D secondary structure diagram of an RNA sequence, with nucleotides numbered from 1 to 35. The structure includes stems, loops, and bulges.
- 6: News:** A small news section at the bottom left.

The status bar at the bottom indicates "Construction of the alignment view" and "8 of 63 MB used".

BGSU RNA bioinformatics

BGSU RNA STRUCTURAL BIOINFORMATICS

Bowling Green State University [/] / Research [//www.bgsu.edu/research.html] / BGSU RNA Structural Bioinformatics

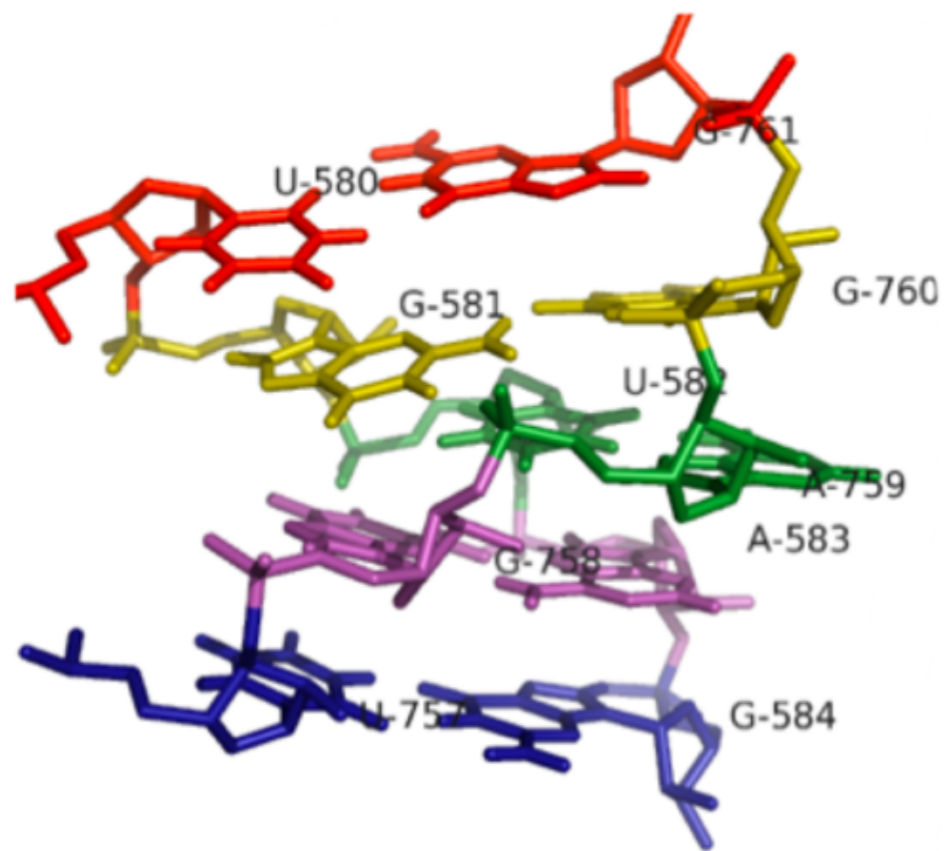

16S *T. thermophilus*

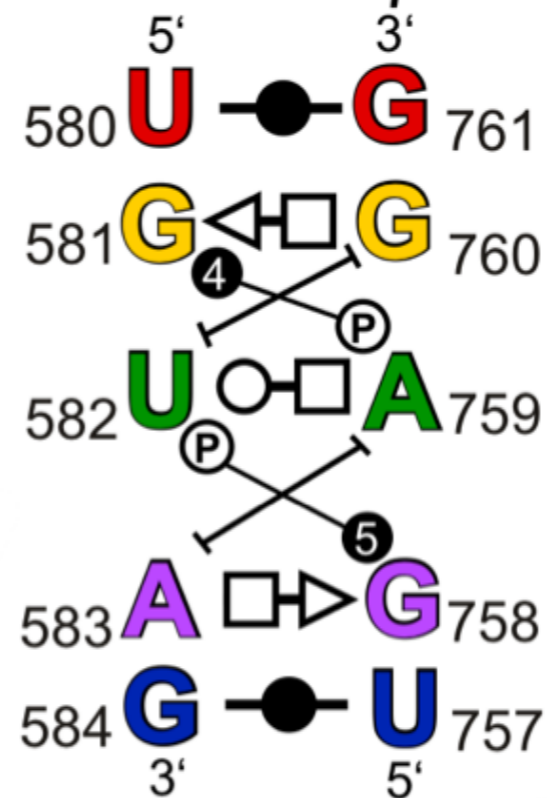

Structural Databases

RNA 3D Hub [<http://rna.bgsu.edu/rna3dhub>] is a new resource, which contains:

- RNA 3D Motif Atlas [<http://rna.bgsu.edu/rna3dhub/motifs>], a representative collection of RNA 3D motifs.
- Non-redundant lists [<http://rna.bgsu.edu/rna3dhub/nrlist>] of RNA-containing 3D structures.

<http://www.bgsu.edu/research/rna/>

Secondary Structure: small subunit ribosomal RNA

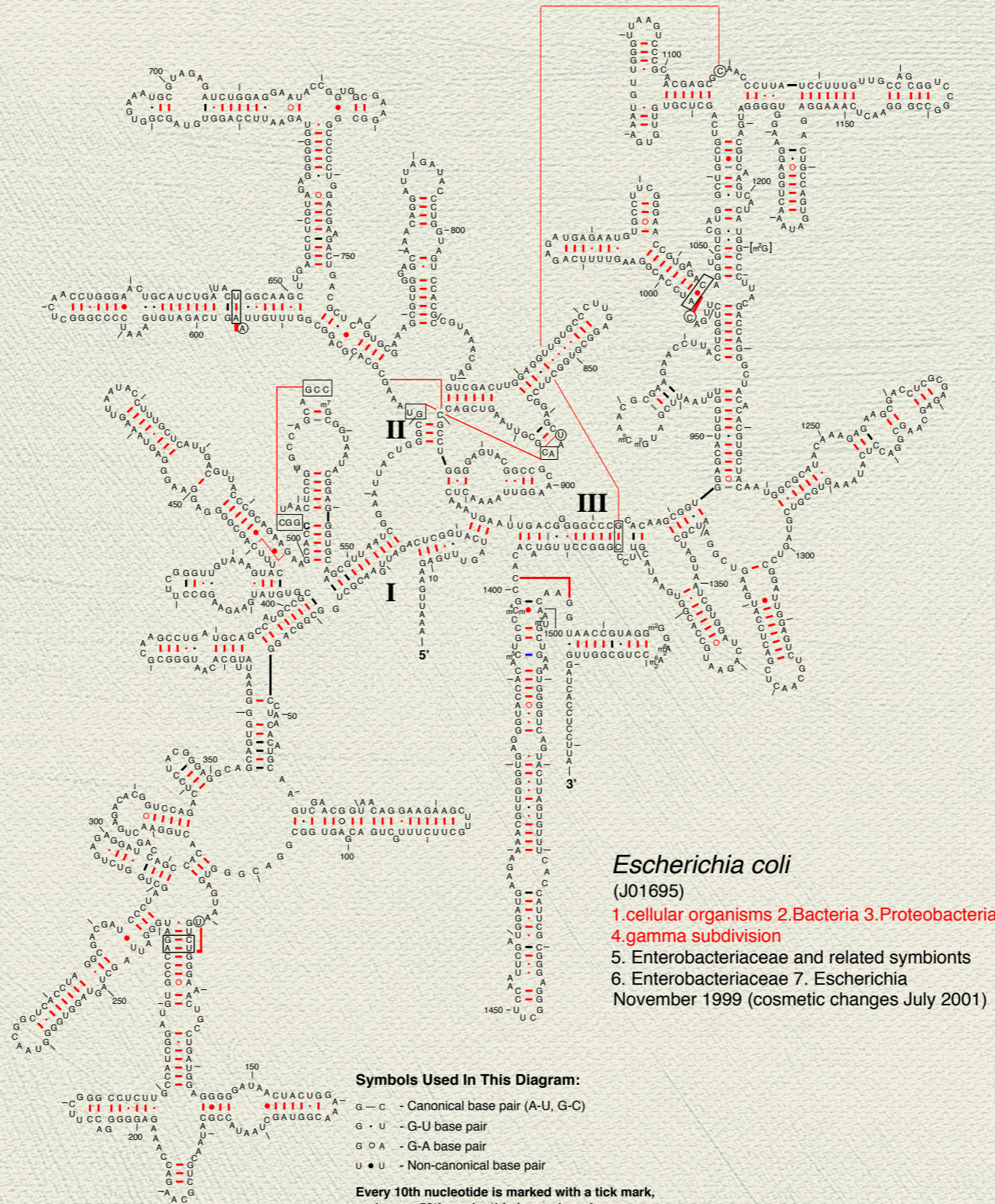

Citation and related information available at <http://www.rna.icmb.utexas.edu>