



**HAL**  
open science

# **Viroids & the RNA World: from genomic scale (RNA) to atomic scale (ribozyme)**

Fabrice Leclerc

## ► **To cite this version:**

Fabrice Leclerc. Viroids & the RNA World: from genomic scale (RNA) to atomic scale (ribozyme). Master. BGA Biochimie et Génétique des ARN, Paris, France. 2020. ⟨hal-03313809⟩

**HAL Id: hal-03313809**

**<https://hal.science/hal-03313809v1>**

Submitted on 6 Aug 2021

**HAL** is a multi-disciplinary open access archive for the deposit and dissemination of scientific research documents, whether they are published or not. The documents may come from teaching and research institutions in France or abroad, or from public or private research centers.

L'archive ouverte pluridisciplinaire **HAL**, est destinée au dépôt et à la diffusion de documents scientifiques de niveau recherche, publiés ou non, émanant des établissements d'enseignement et de recherche français ou étrangers, des laboratoires publics ou privés.



Distributed under a Creative Commons CC0 1.0 - Universal - International License

# Viroids & the RNA World

**Fabrice Leclerc**

Institute for Integrative Biology of the  
Cell (I2BC)

CNRS-CEA-Univ. Paris Saclay

[fabrice.leclerc@i2bc.paris-saclay.fr](mailto:fabrice.leclerc@i2bc.paris-saclay.fr)



# Viroids

# &

# the RNA World

## from genomic scale (RNA)

## to

## atomic scale (ribozyme)

# HHRz

# 79-NT

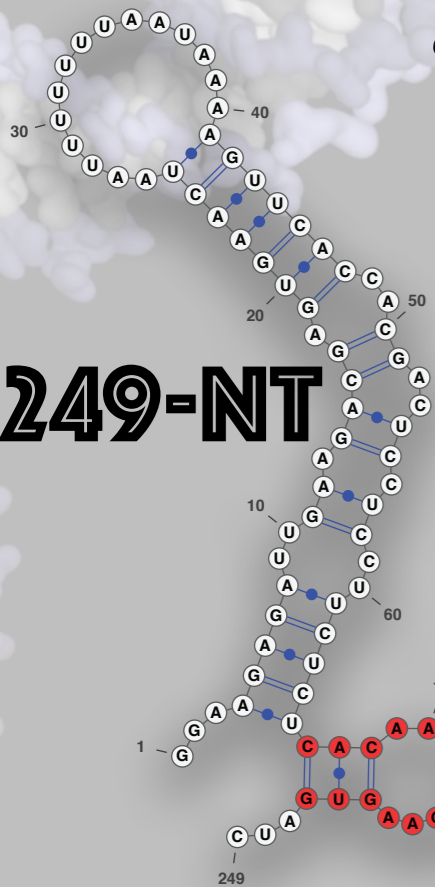
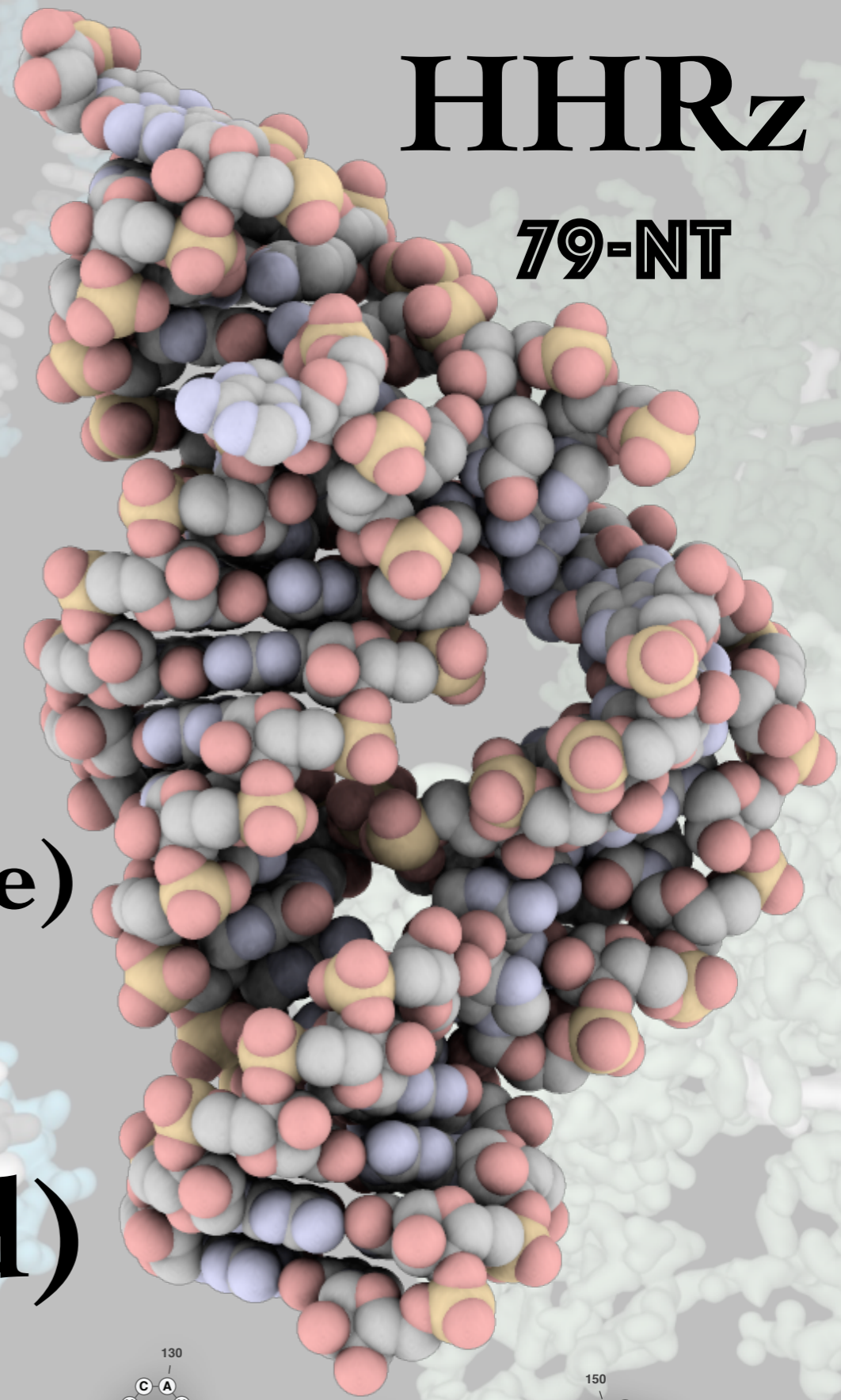

# Viroid (ASBVd)

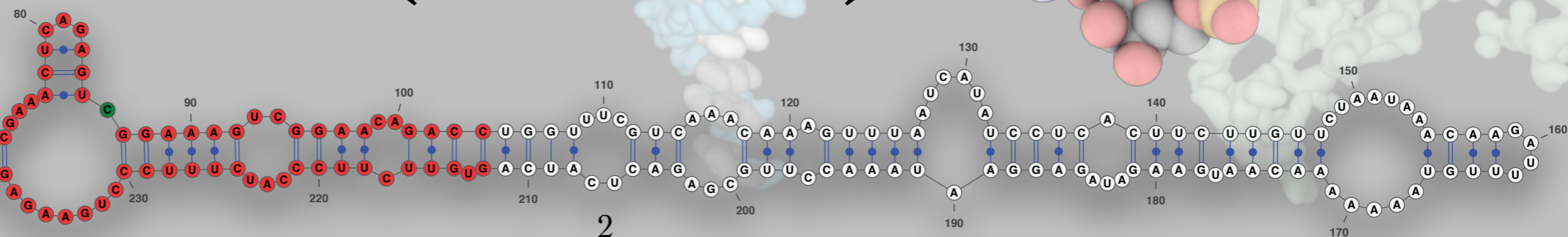

# Introduction

- evolution (RNA world) & genomics
- RNA biology & RNomics  
(molecular and cellular functions)
- structural biology & structural  
bioinformatics (structural basis for  
functions)
- enzymology & computational enzymology  
(catalysis)

# Prebiotic & RNA Worlds

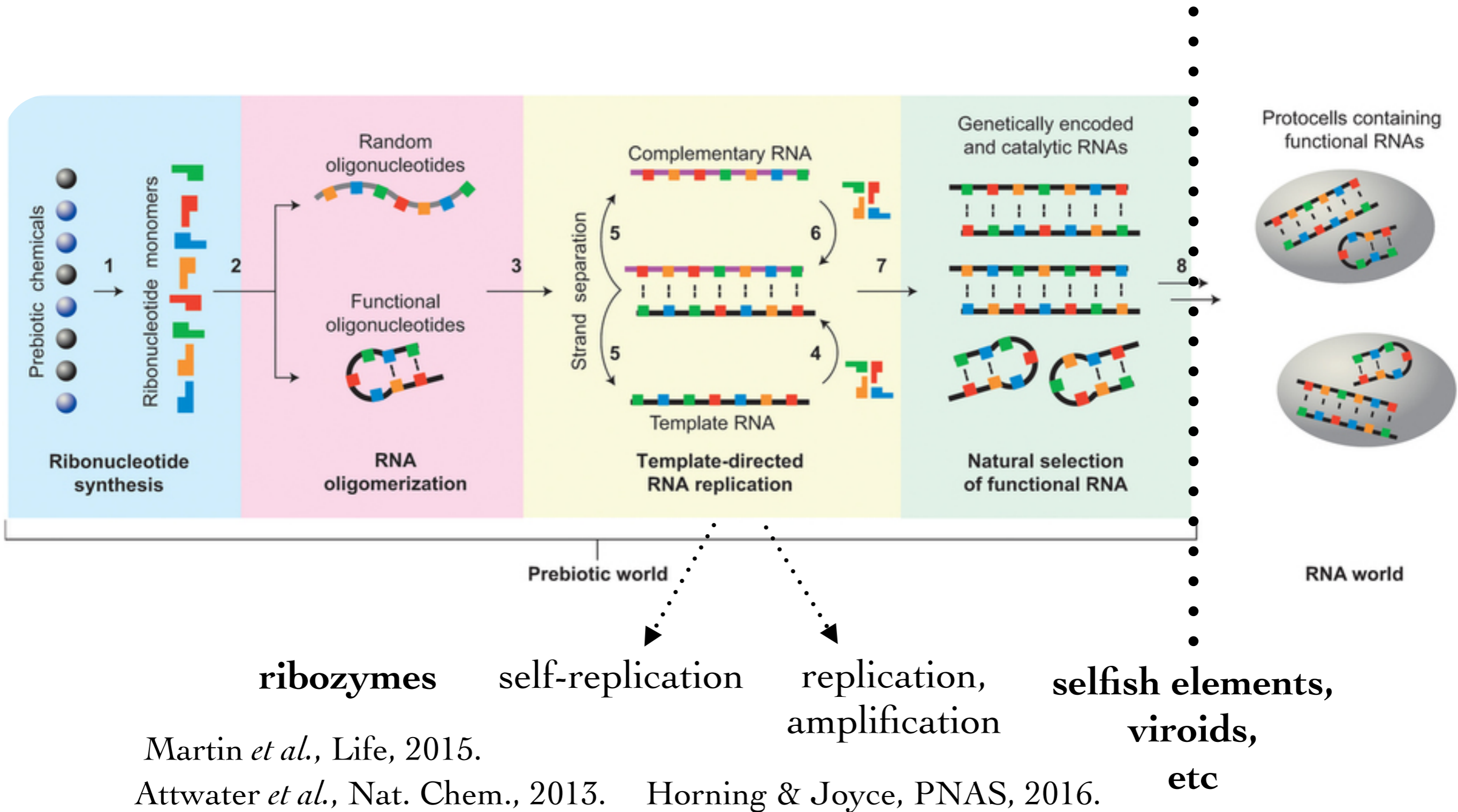

# Virus World & RNA World

viroids

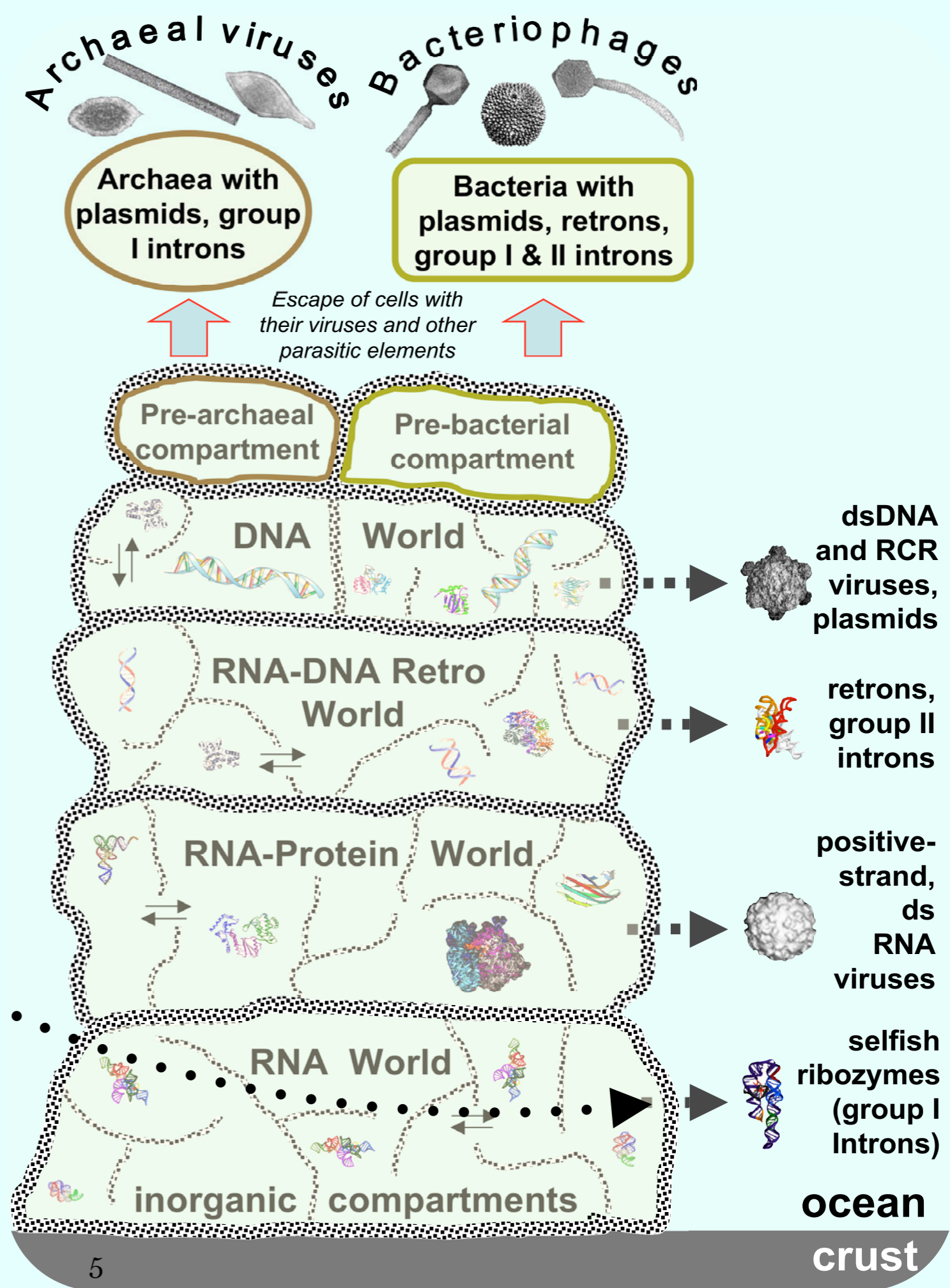

« The ancient Virus World and evolution of cells »

# Viroids: « survivors from the RNA World »

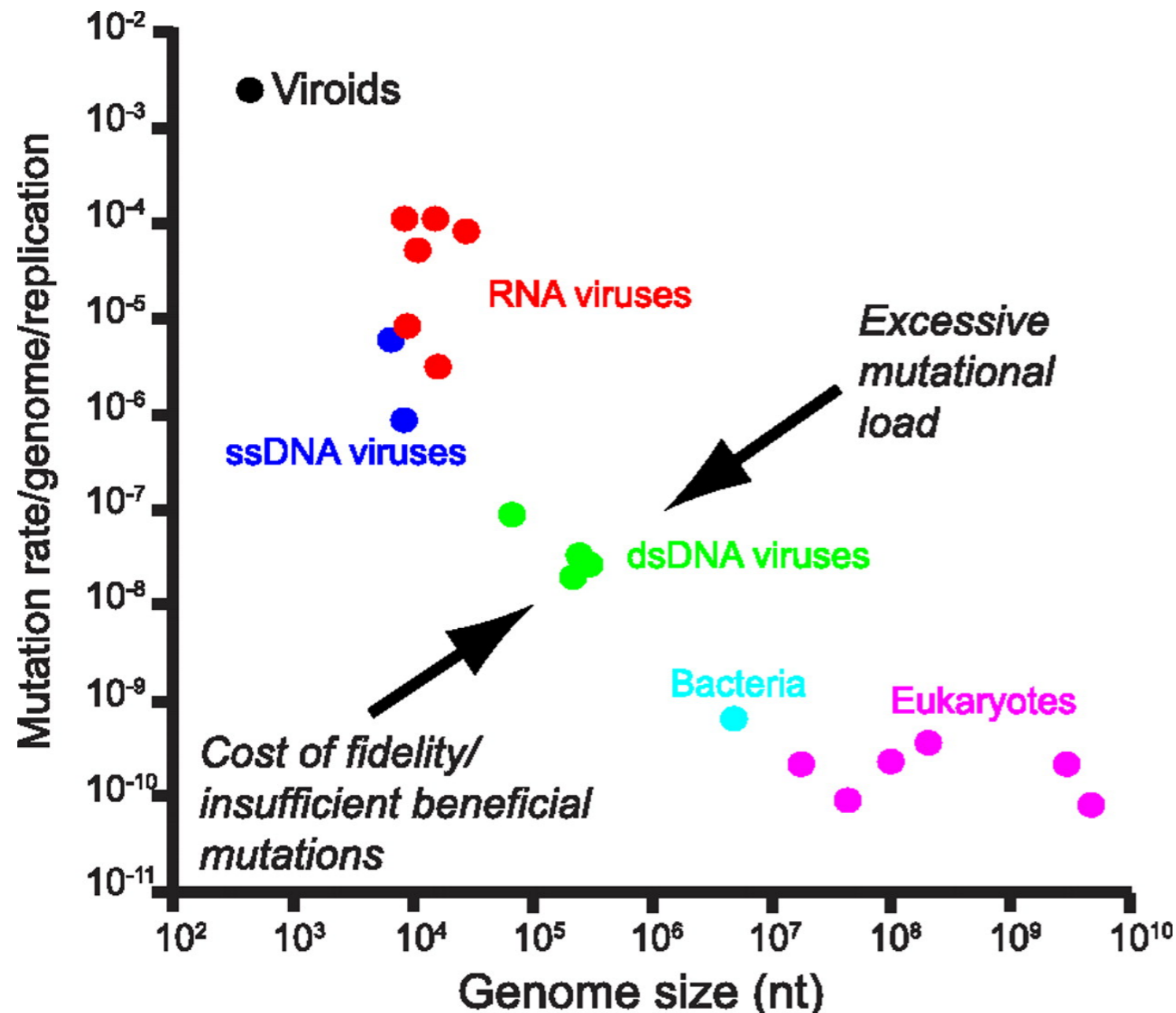

Holmes, J. Virol., 2011

## functions

- error-prone replication

- small size

- high GC

- replication fidelity

- circRNA

- replication

- periodicity

- genome assembly

- no protein-coding

- ribosome-free

- ribozyme

## features

- replication

# Viroids: Families

FAMILY

SUBFAMILY

GENUS

SPECIES

*Pospiviroidae*

*Pospiviroinae*

*Pospiviroids*

**Potato spindle tuber (PSTVd)**  
 Mexican papita (MPVd)  
 Tomato planta macho (TPMVd)  
 Chrysanthemum stunt (CSVd)  
 Citrus exocortis (CEVd)  
 Tomato apical stunt (TASVd)  
 Iresine 1 (IrVd 1)  
 Columnea latent (CLVd)

*Hostuviroids*

**Hop stunt (HSVd)**

*Cocadviroids*

**Coconut cadang-cadang (CCCVd)**  
 Coconut tinangaja (CTIVd)  
 Hop latent (HLVd)  
 Citrus IV (CVd-IV)

*Apscaviroinae*

*Apscaviroids*

**Apple scar skin (ASSVd)**  
 Citrus III (CVd-III)  
 Apple dimple fruit (ADFVd)  
 Grapevine yellow speckle 1 (GYSVd 1)  
 Grapevine yellow speckle 2 (GYSVd 2)  
 Citrus bent leaf (CBLVd)  
 Pear blister canker (PBCVd)  
 Australian grapevine (AGVd)

*Coleviroinae*

*Coleviroids*

**Coleus blumei 1 (CbVd 1)**  
 Coleus blumei 2 (CbVd 2)  
 Coleus blumei 3 (CbVd 3)

*Avsunviroidae*

Flores *et al.*,  
 Arch. Virol.,  
 1998.

*Avsunviroids*

**Avocado sunblotch (ASBVd)**

*Pelamoviroids*

**Peach latent mosaic (PLMVd)**  
 Chrysanthemum chlorotic mottle (CChMVd)

PSTVd

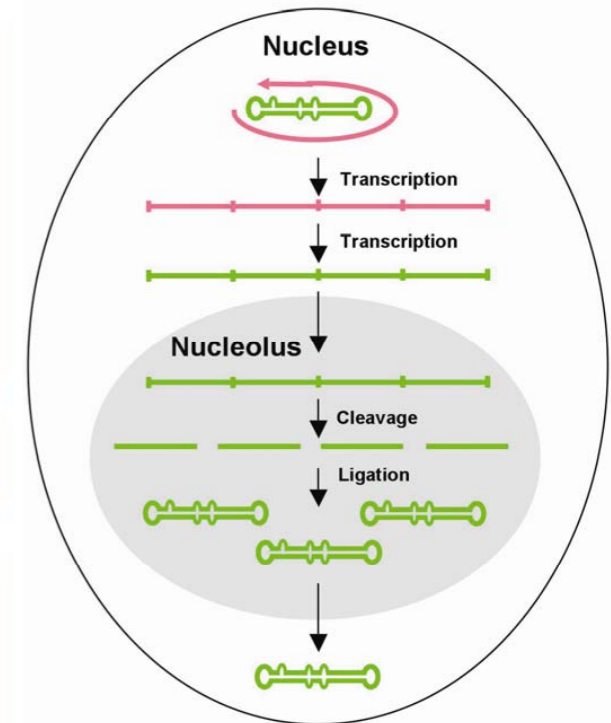

ASBVd

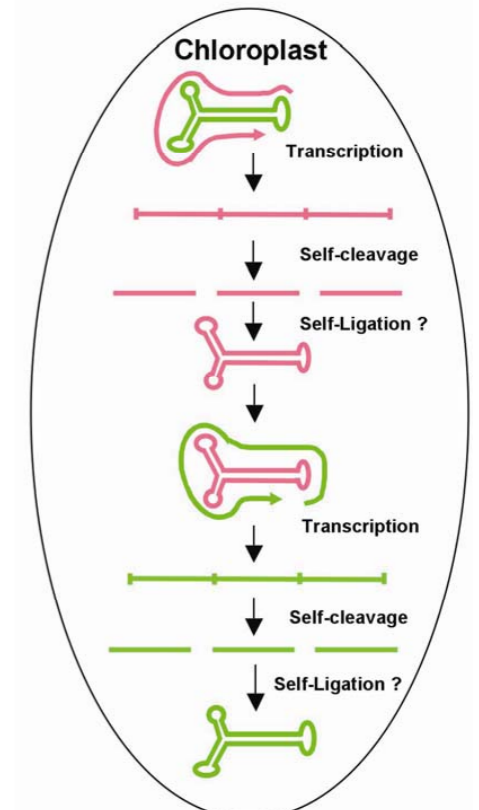

# Viroids: Plant Parasites

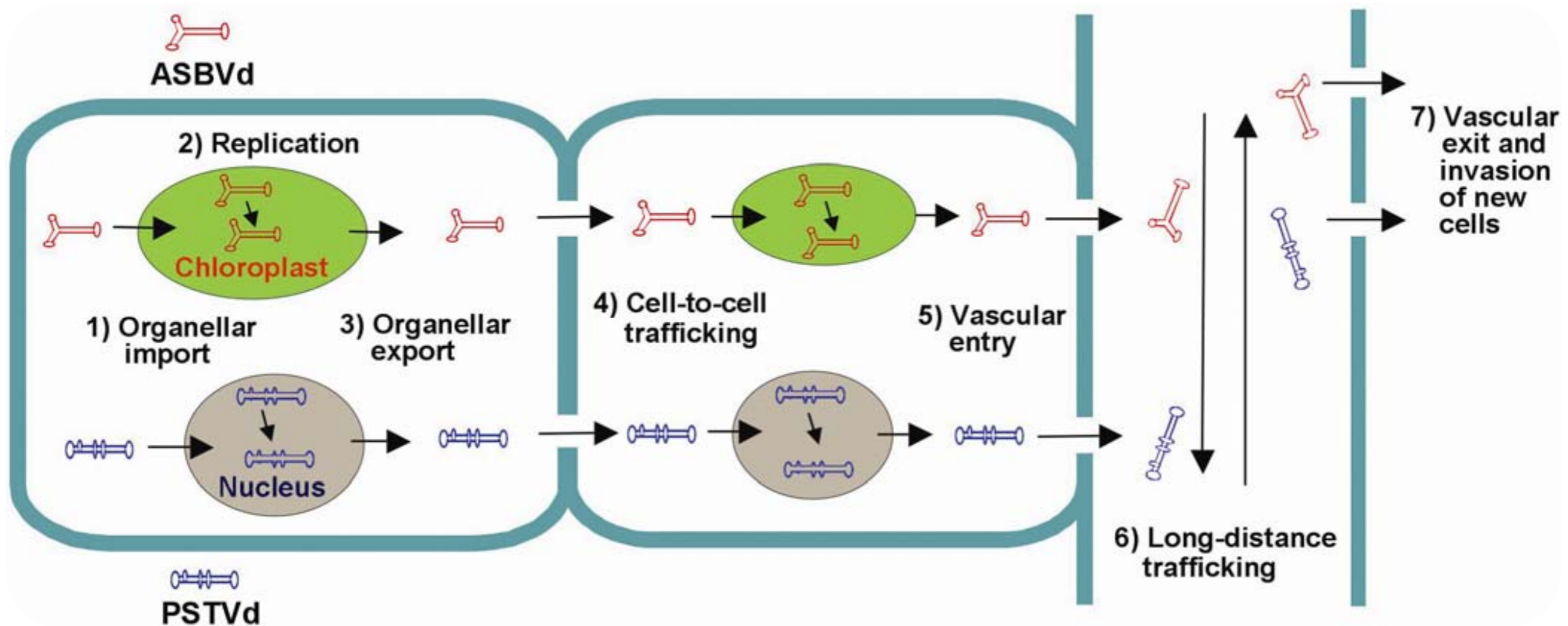

Ding & Itaya, Mol Plant Microbe Interact, 2007.

# Viroids: Replication

Asymmetric pathway (family *Pospiviroidae*)

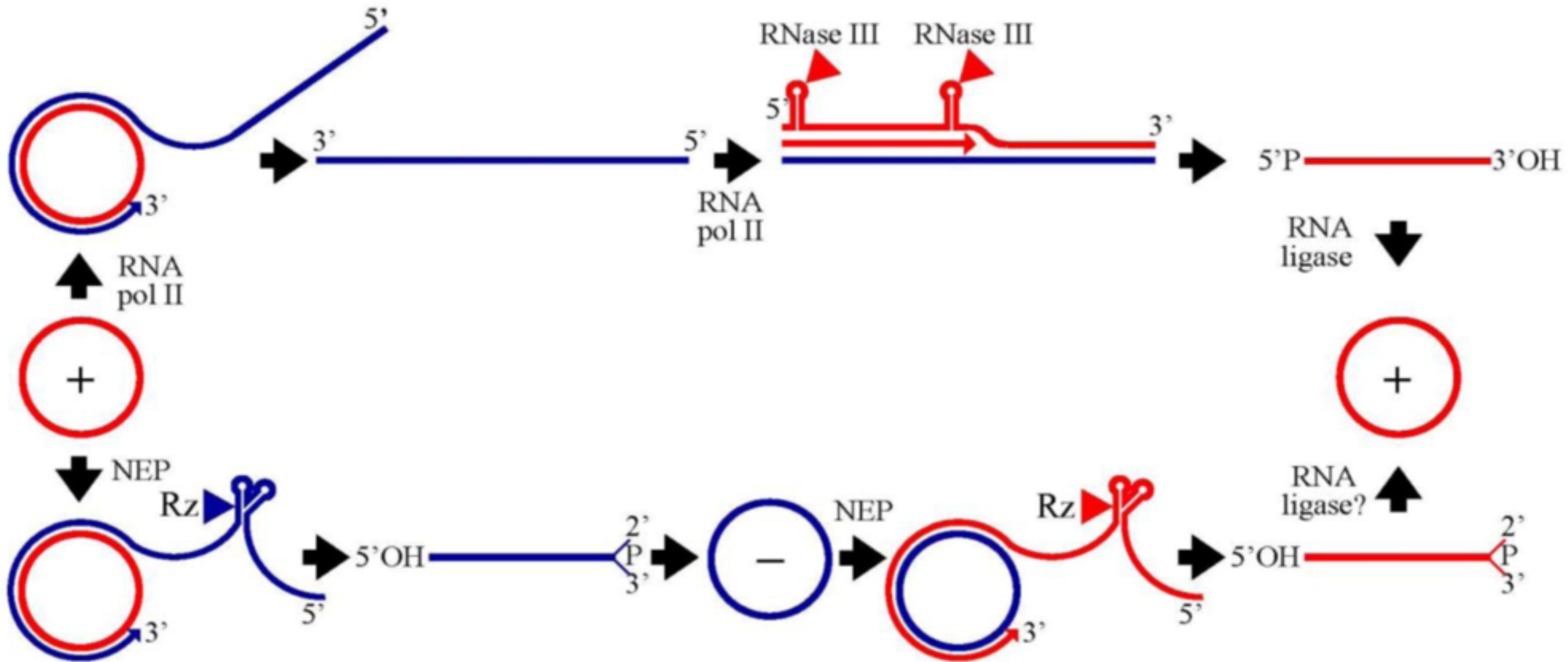

Rz: hammerhead ribozyme

# Viroids: 2D Structures

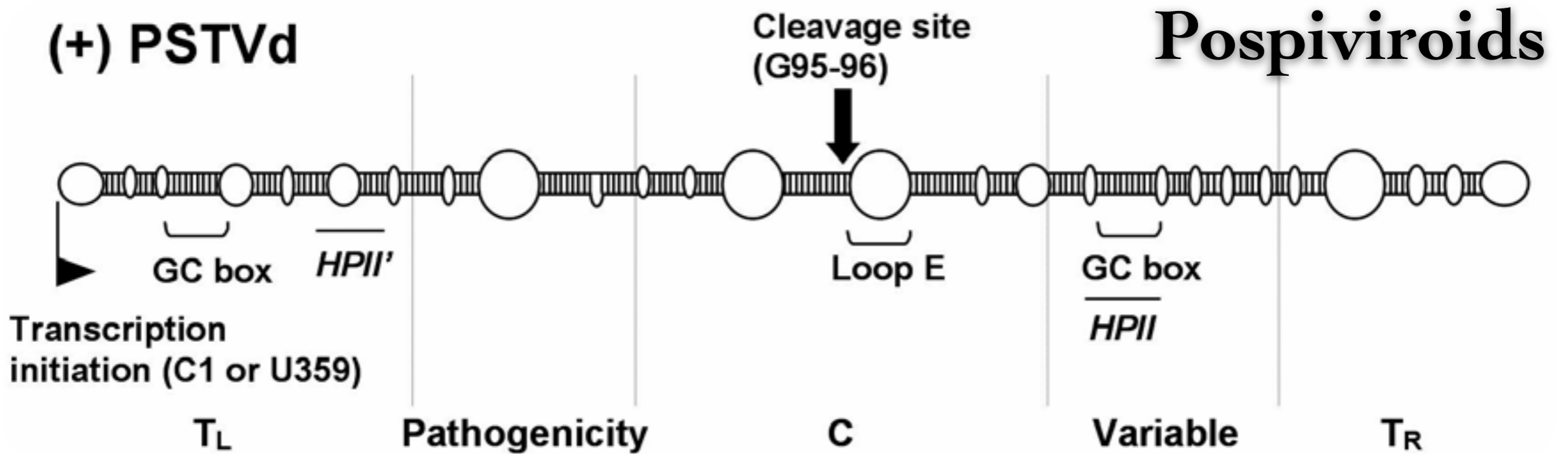

**(+) PLMVd**

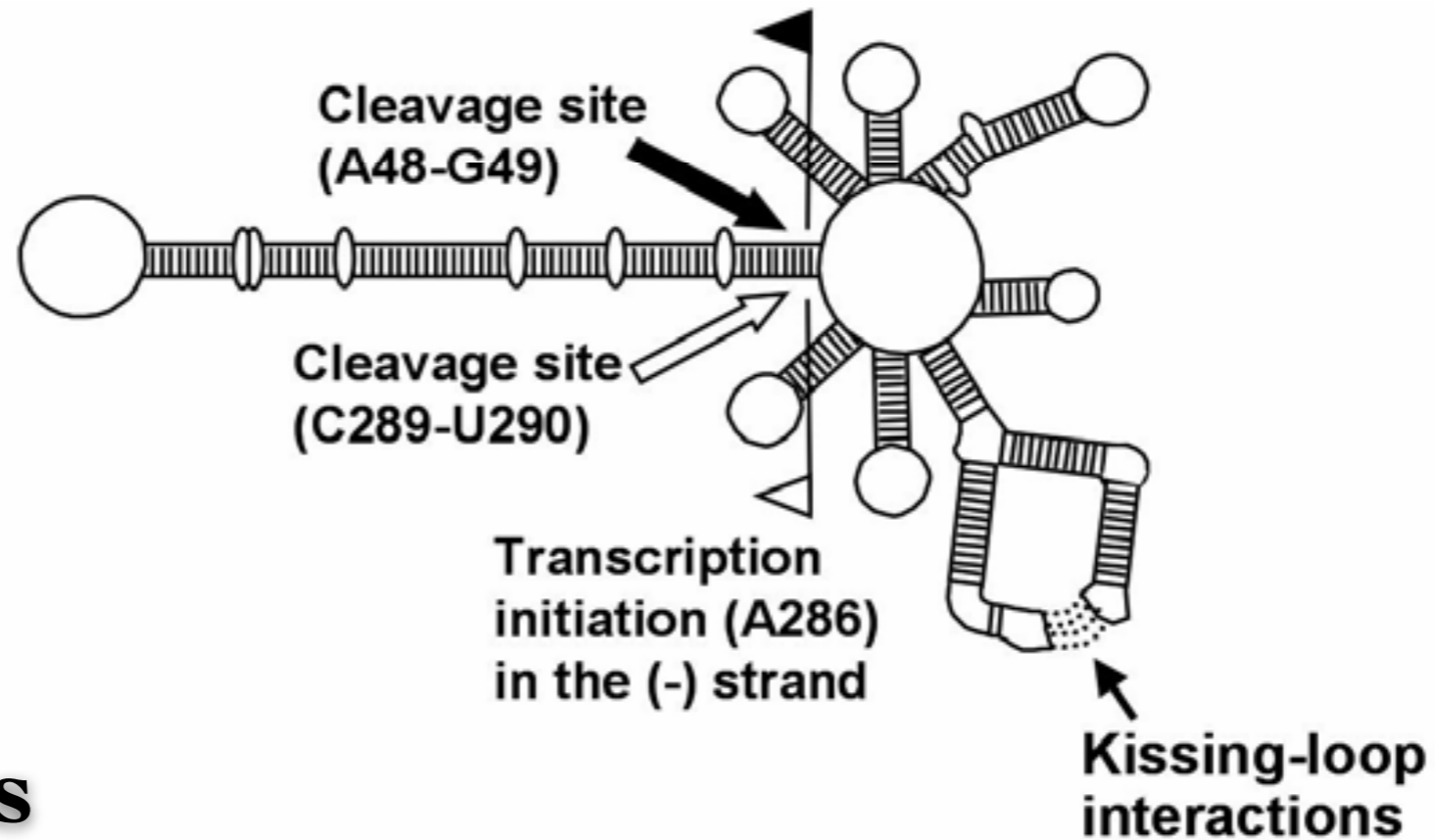



# Viroids: Avsunviroids

A Pelamoviroids

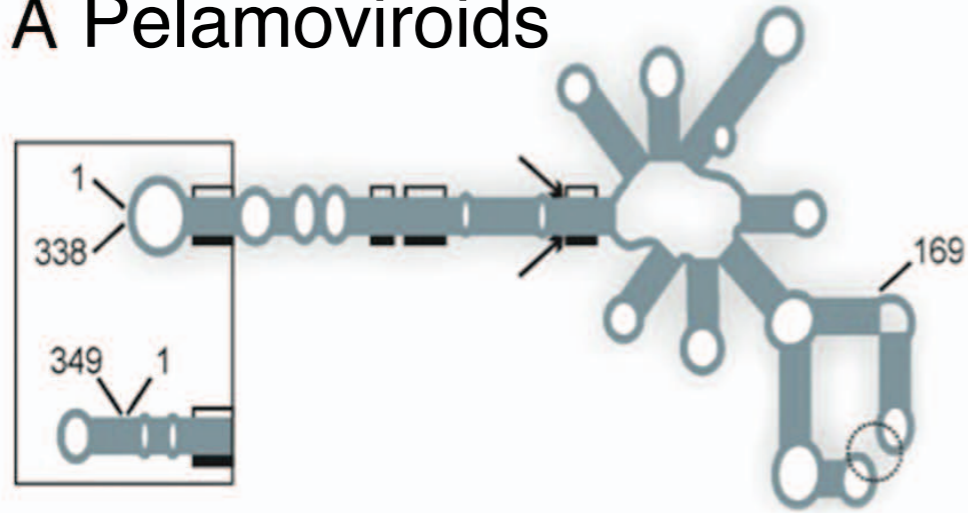

B Avsunviroids



C

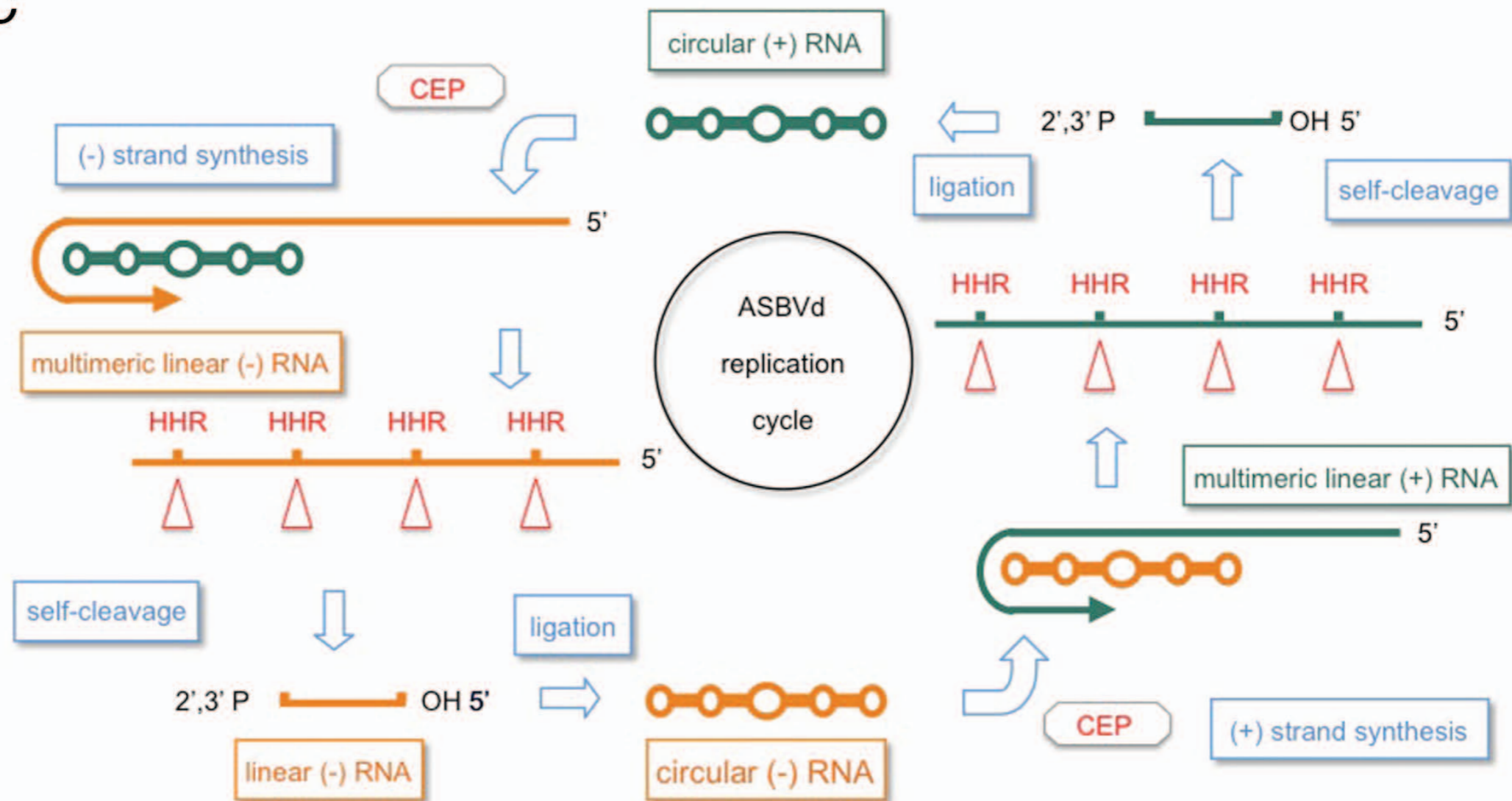

# Viroids & RNA silencing

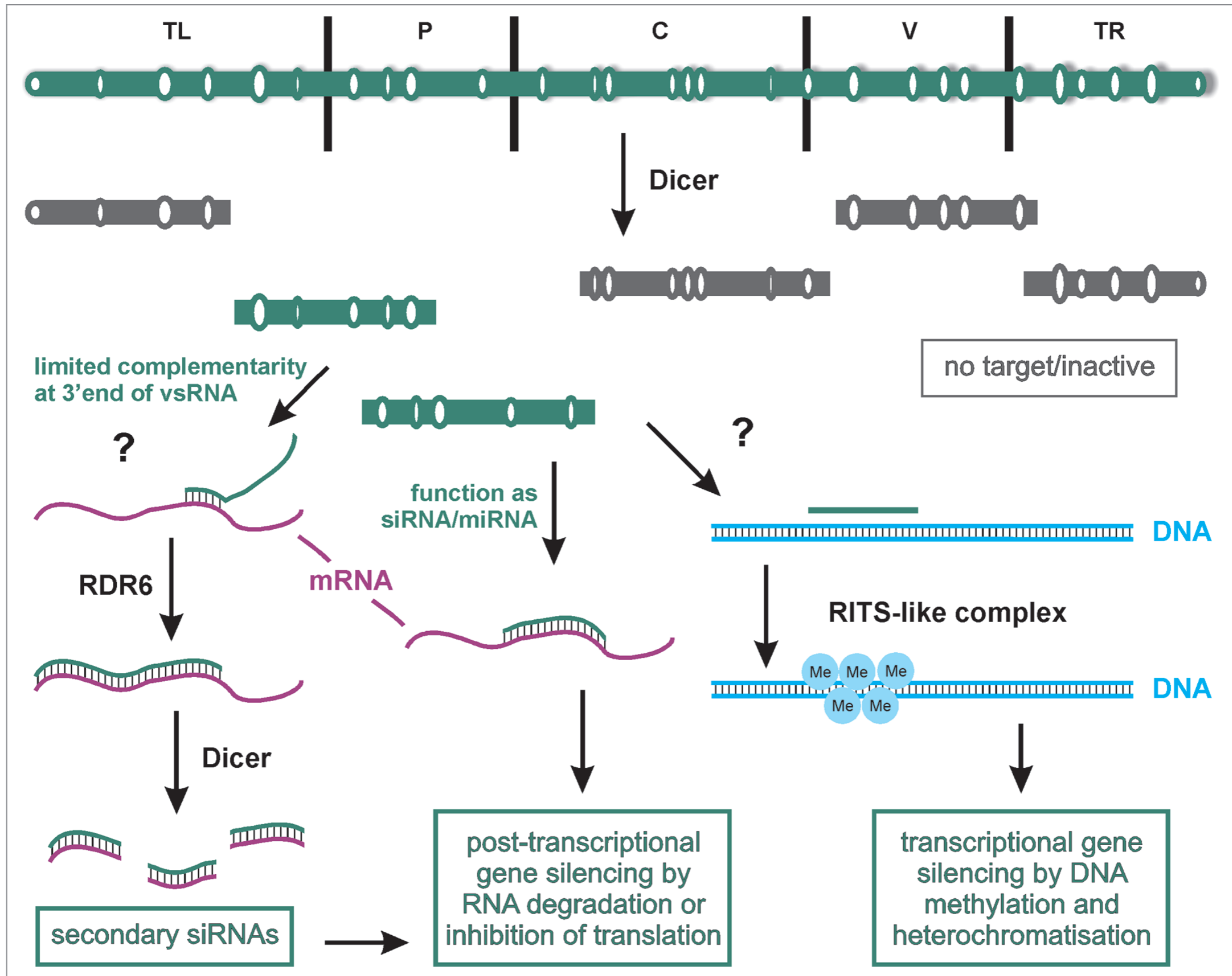

# ASBVd: 2D Structures

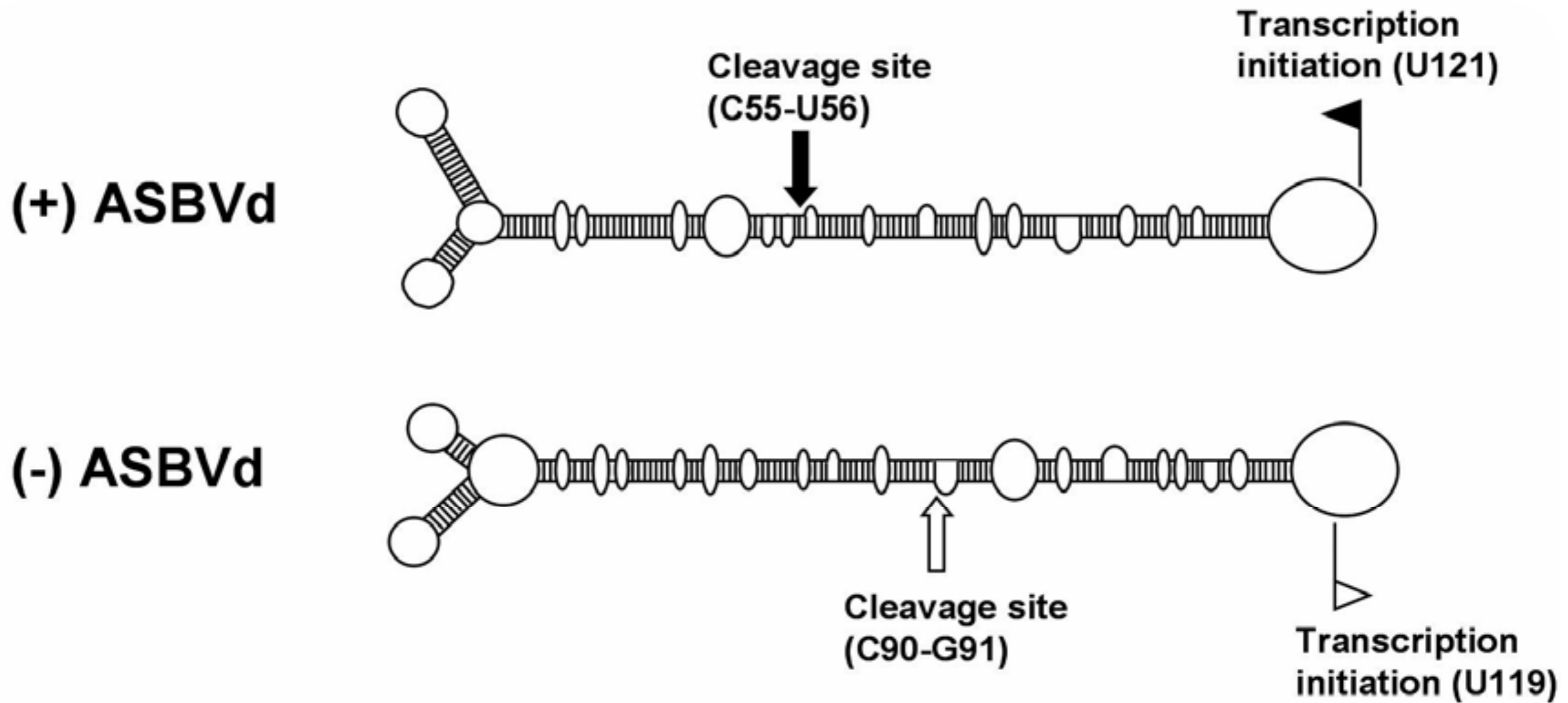

Ding & Itaya, Mol Plant Microbe Interact, 2007.

# ASBVd(-): 2D Structures

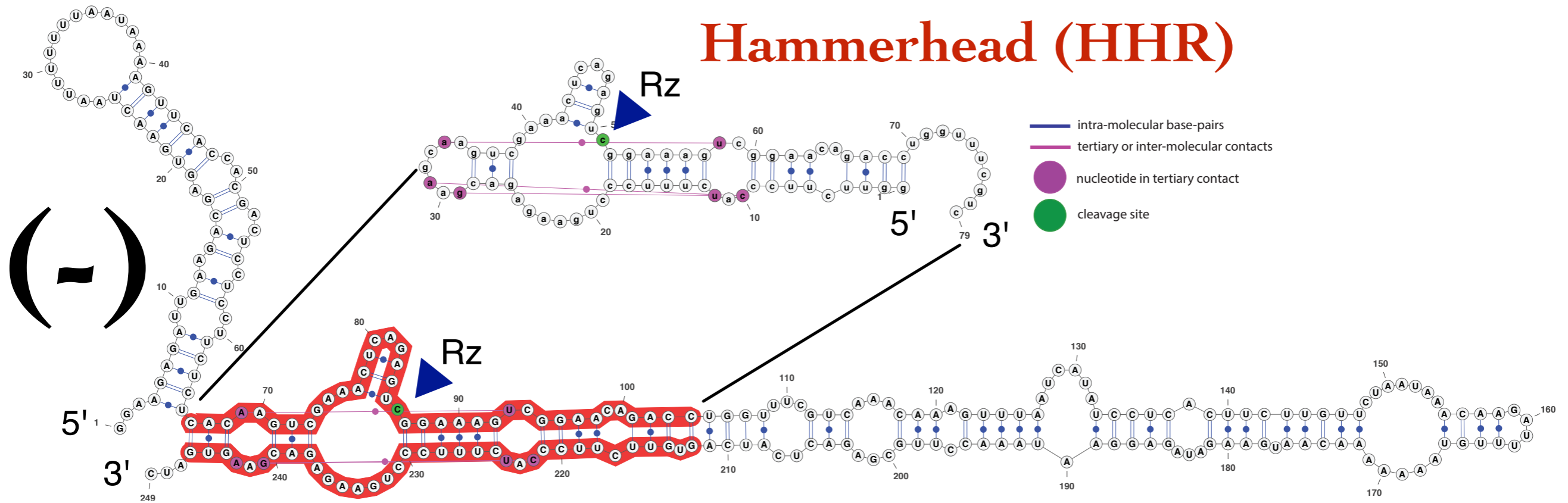

Leclerc *et al.*, Sci. Rep., 2016.



Flores *et al.*, Adv, Virus Res., 2000.

# HHH motifs in life forms

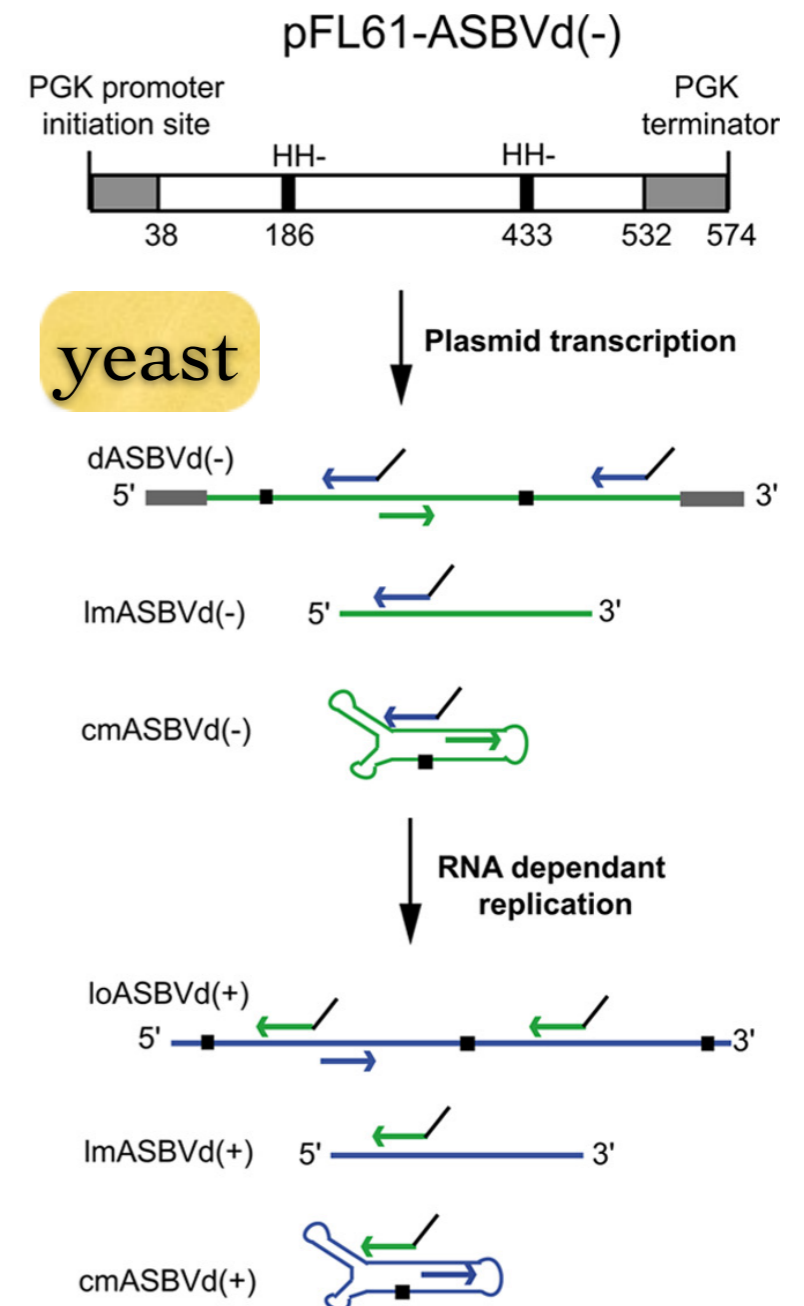
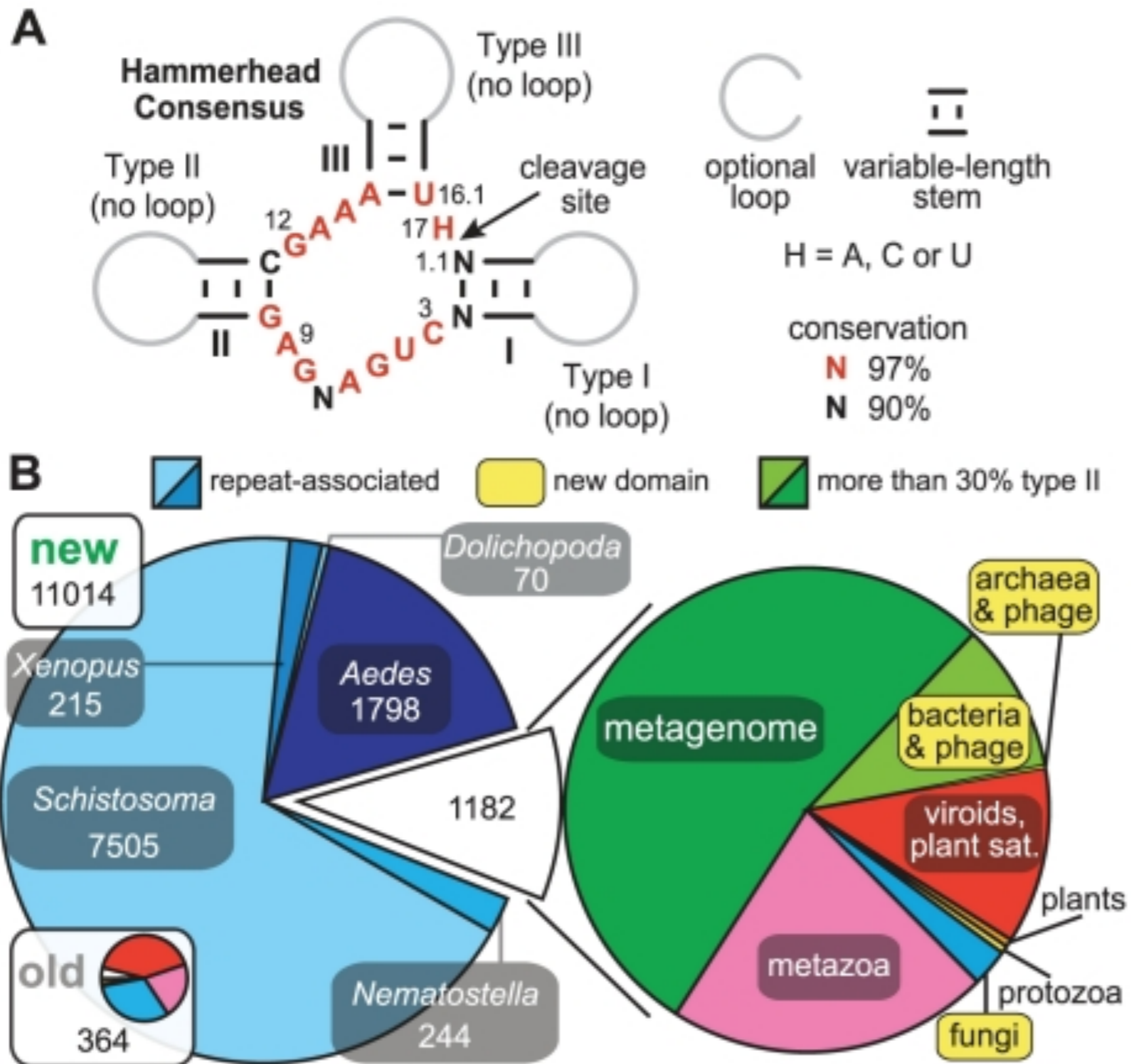

Delan-Forino *et al.*,  
 J. Virol., 2011.  
 Perreault *et al.*,  
 PLoS Comput. Biol., 2011  
 Gupta & Swati,  
 Interdiscip. Sci., 2016.

# A prototype for RNA Catalysis

“Minimum” Hammerhead Ribozyme

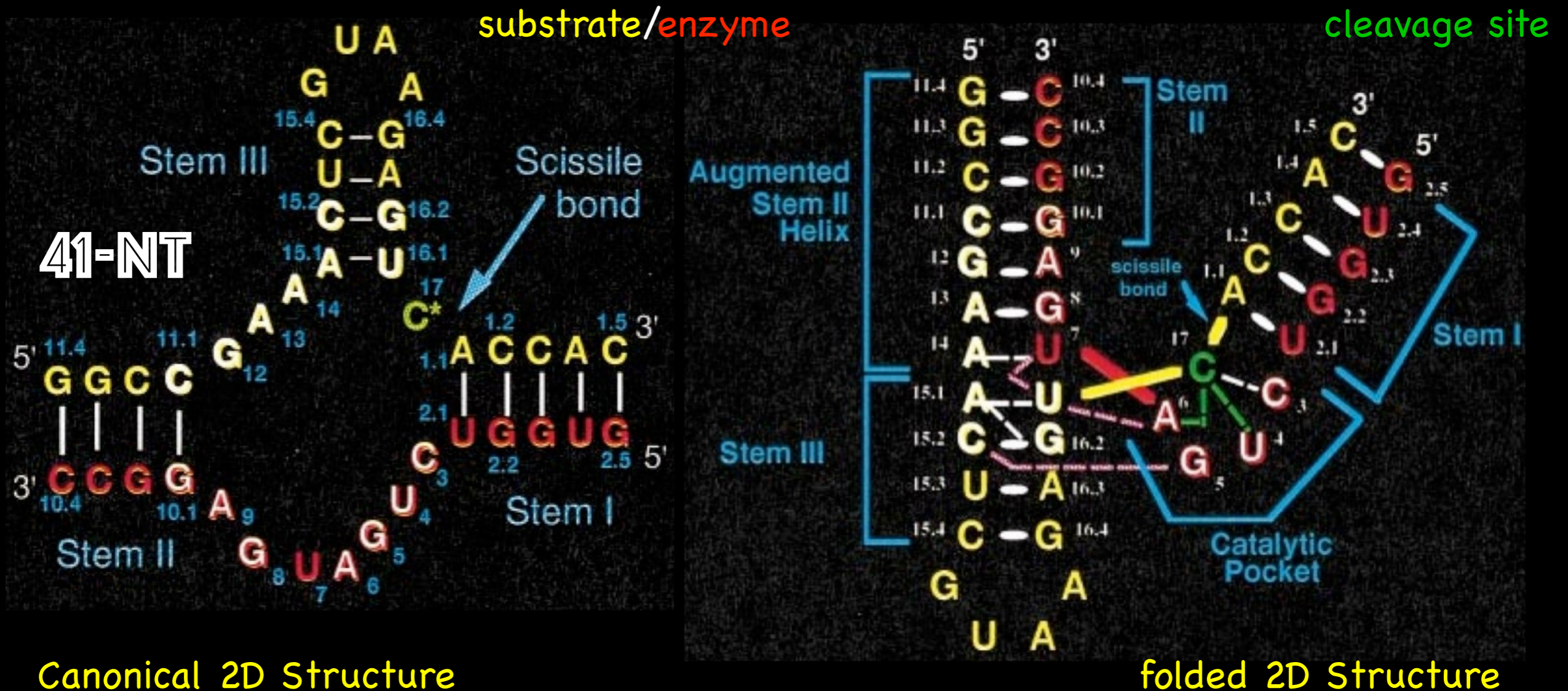

# Self-Cleaving / Self-Splicing

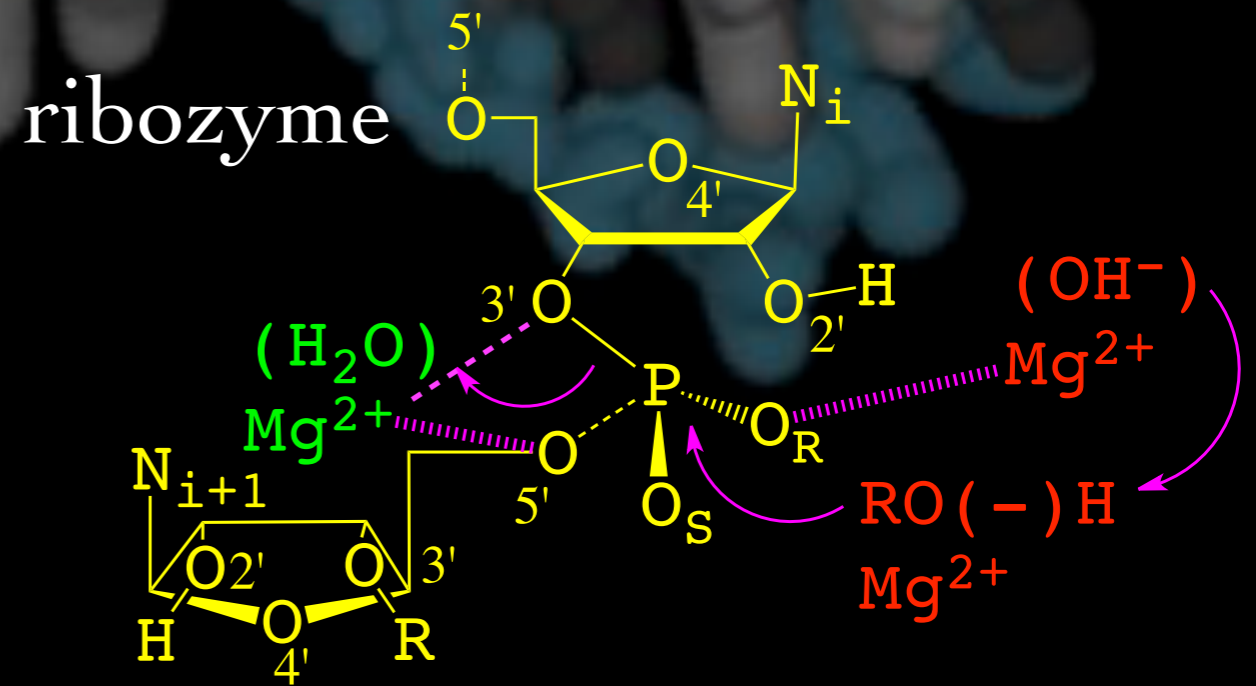
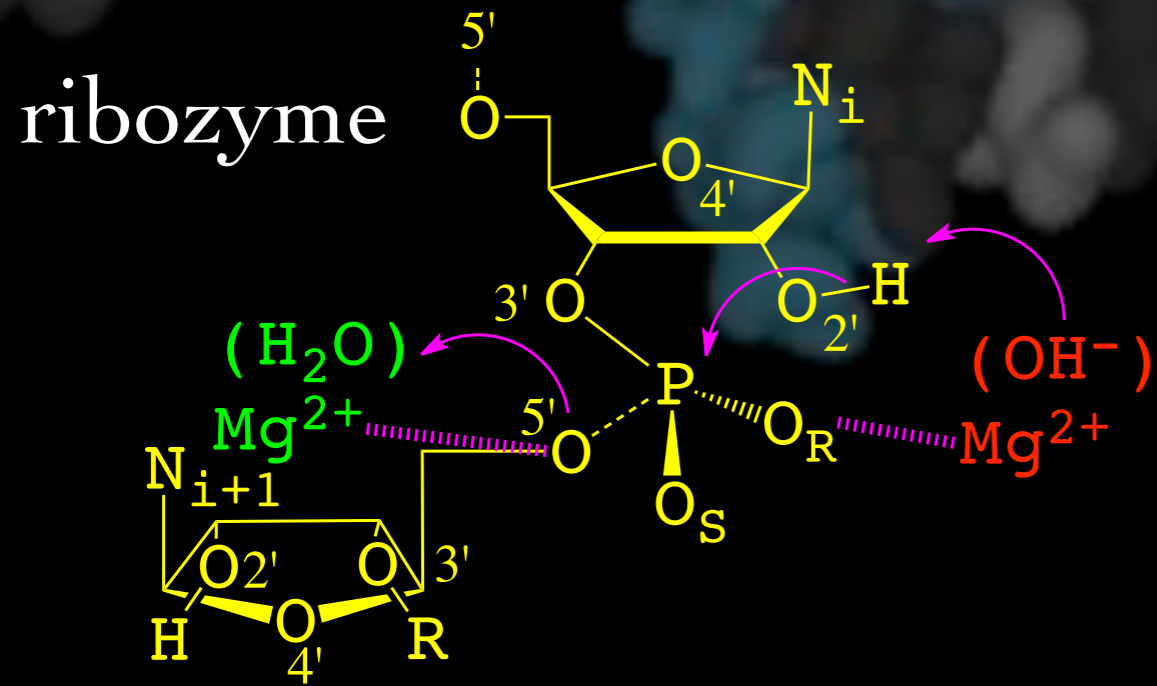

S<sub>N</sub>2(P) reaction  
("in-line")

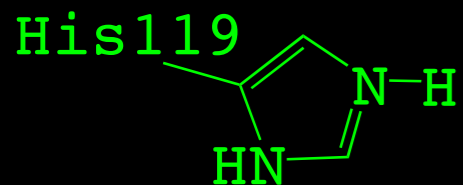
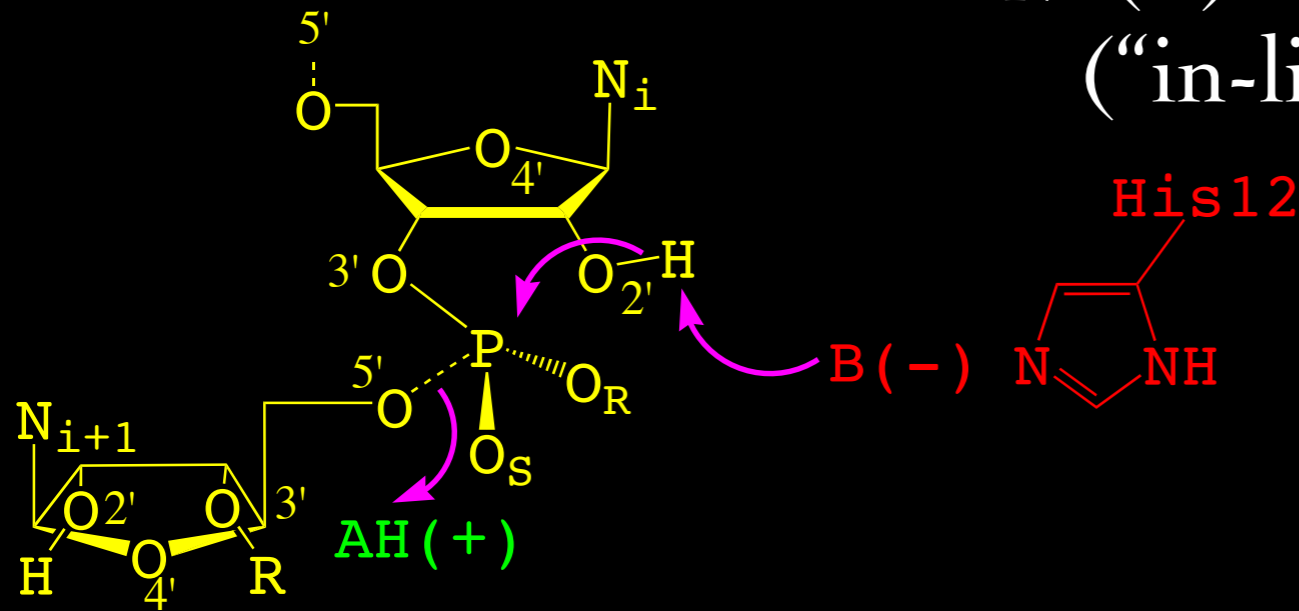

RNase A

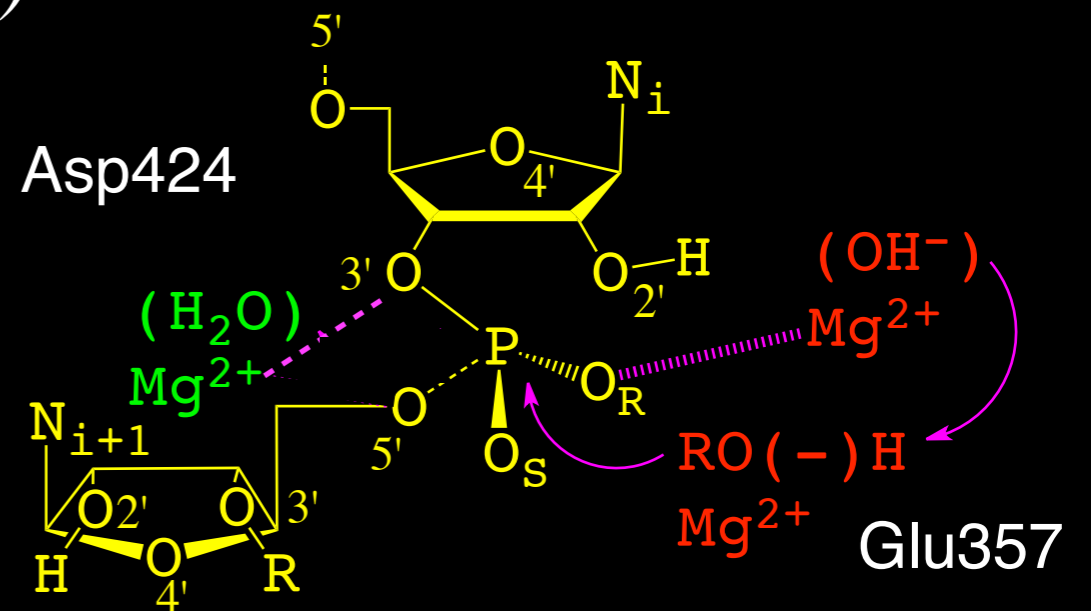

3'-5'-exonuclease

# Catalytic Metal Ions: One/

# Two

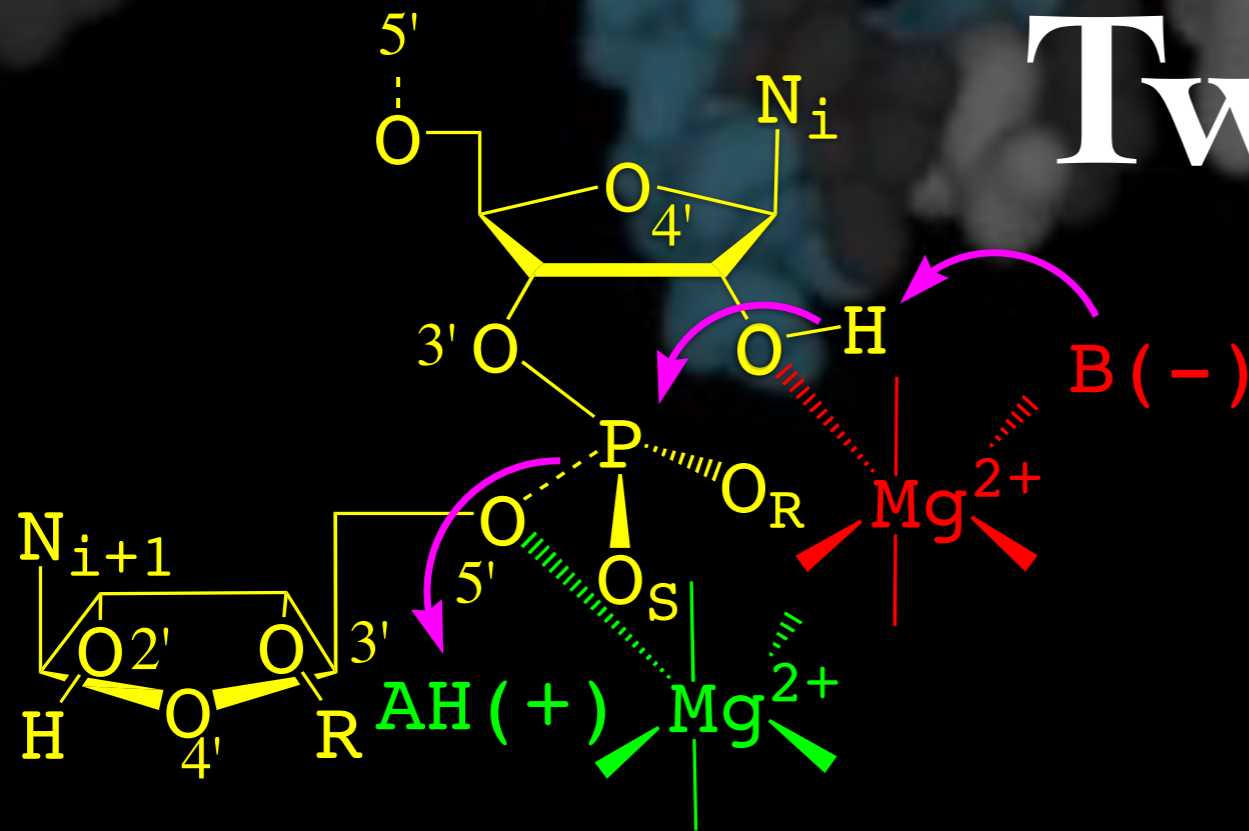

X-ray (active)

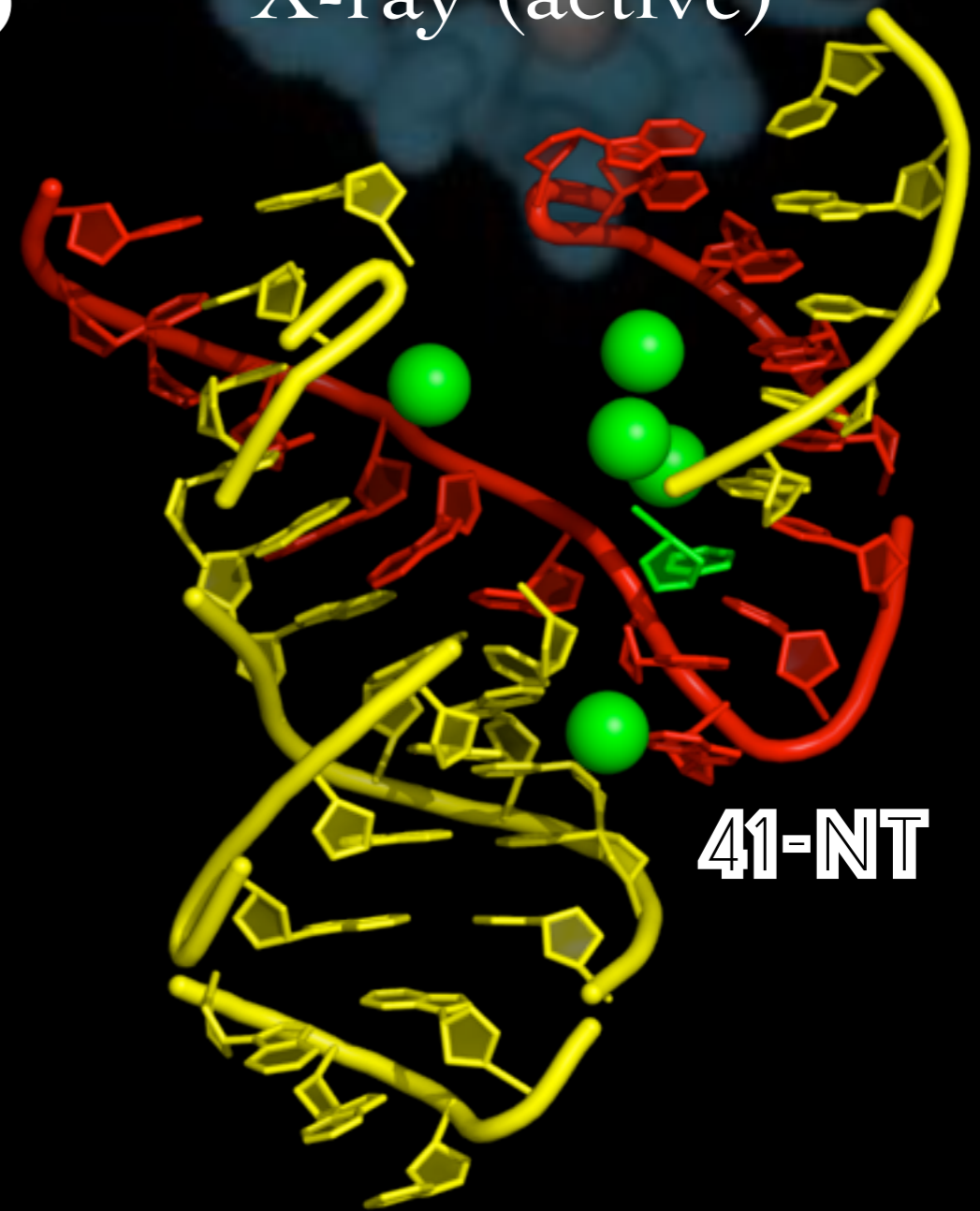

41-NT

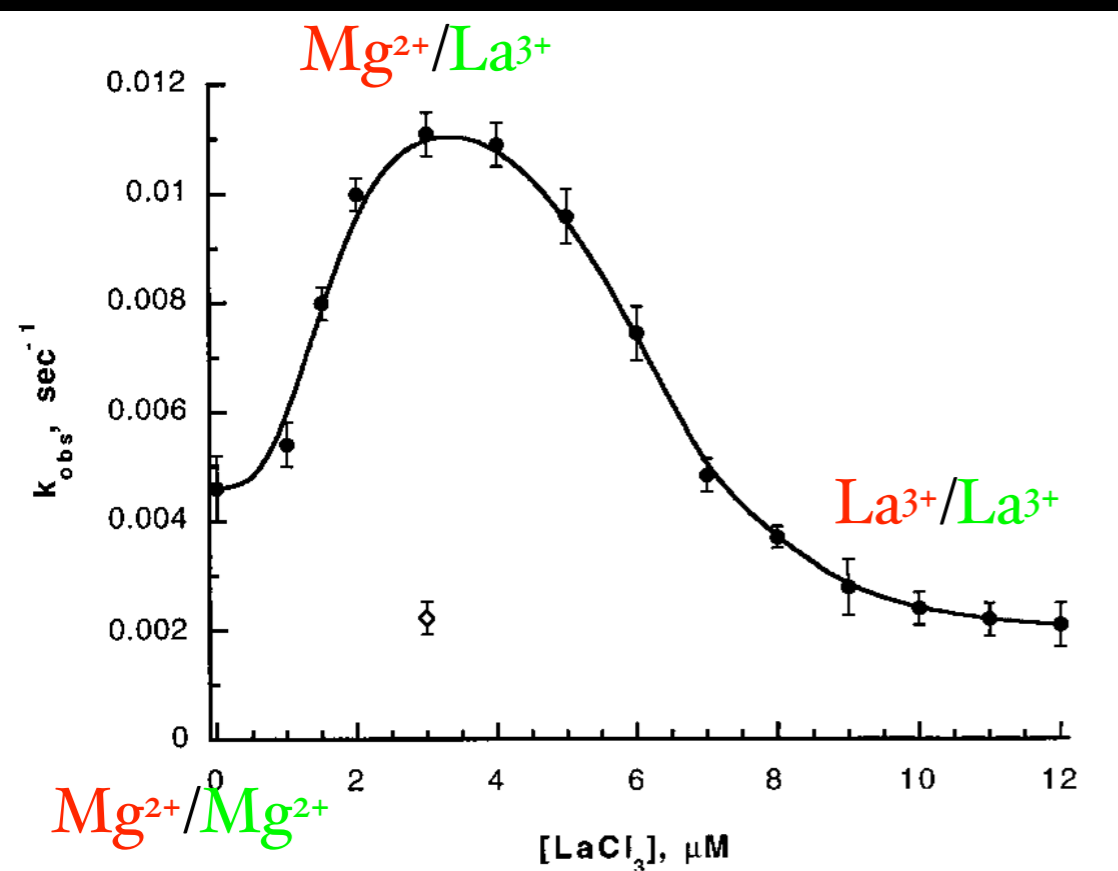

experimental: Pontius *et al.*, 1997; Lott *et al.*, 1998

theoretical: Boero *et al.*, JCTC, 2005

theoretical: Leclerc & Karplus, JPC, 2006

# Contribution of Metals to Catalysis

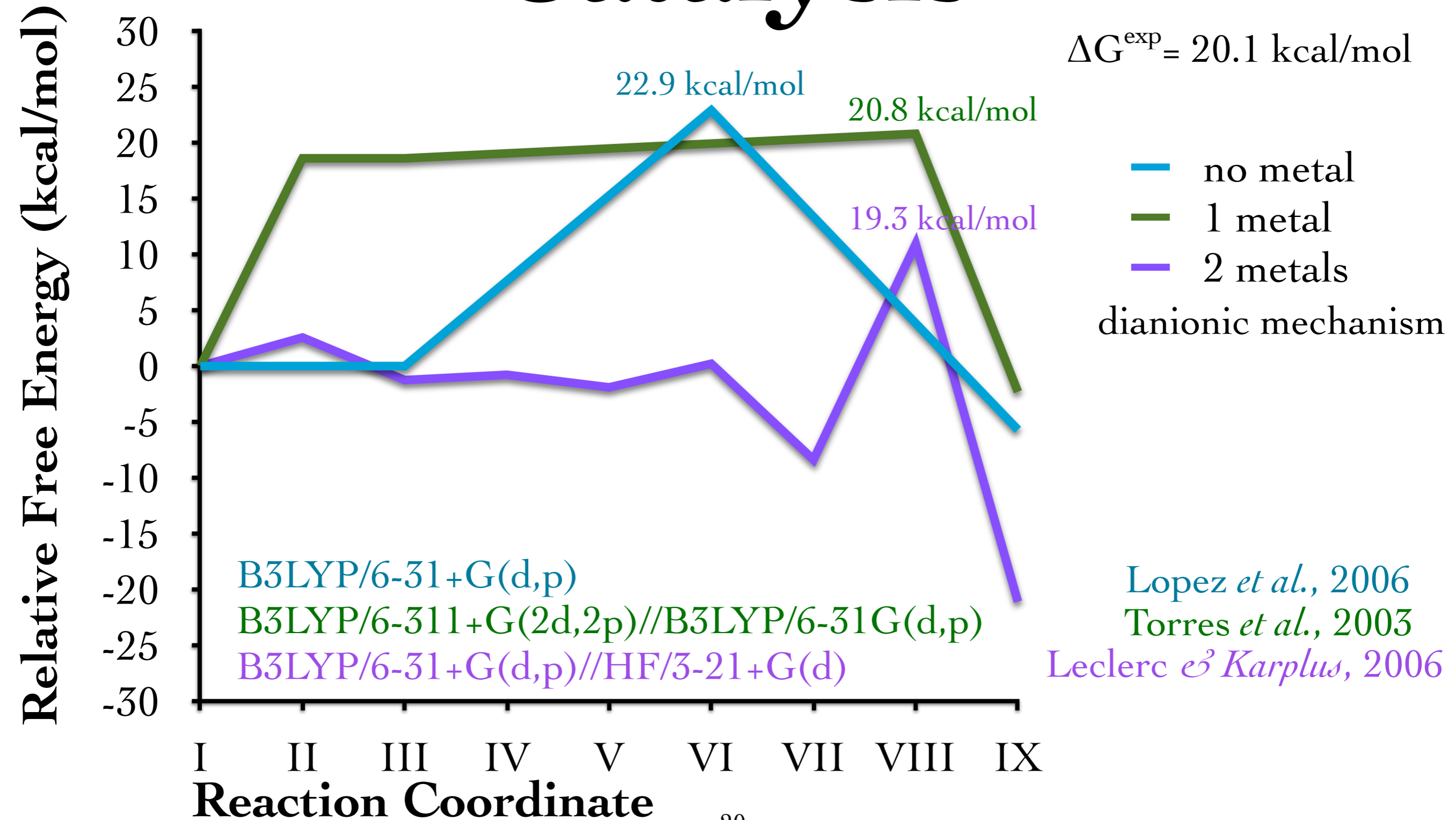

# HHR: reaction mechanism

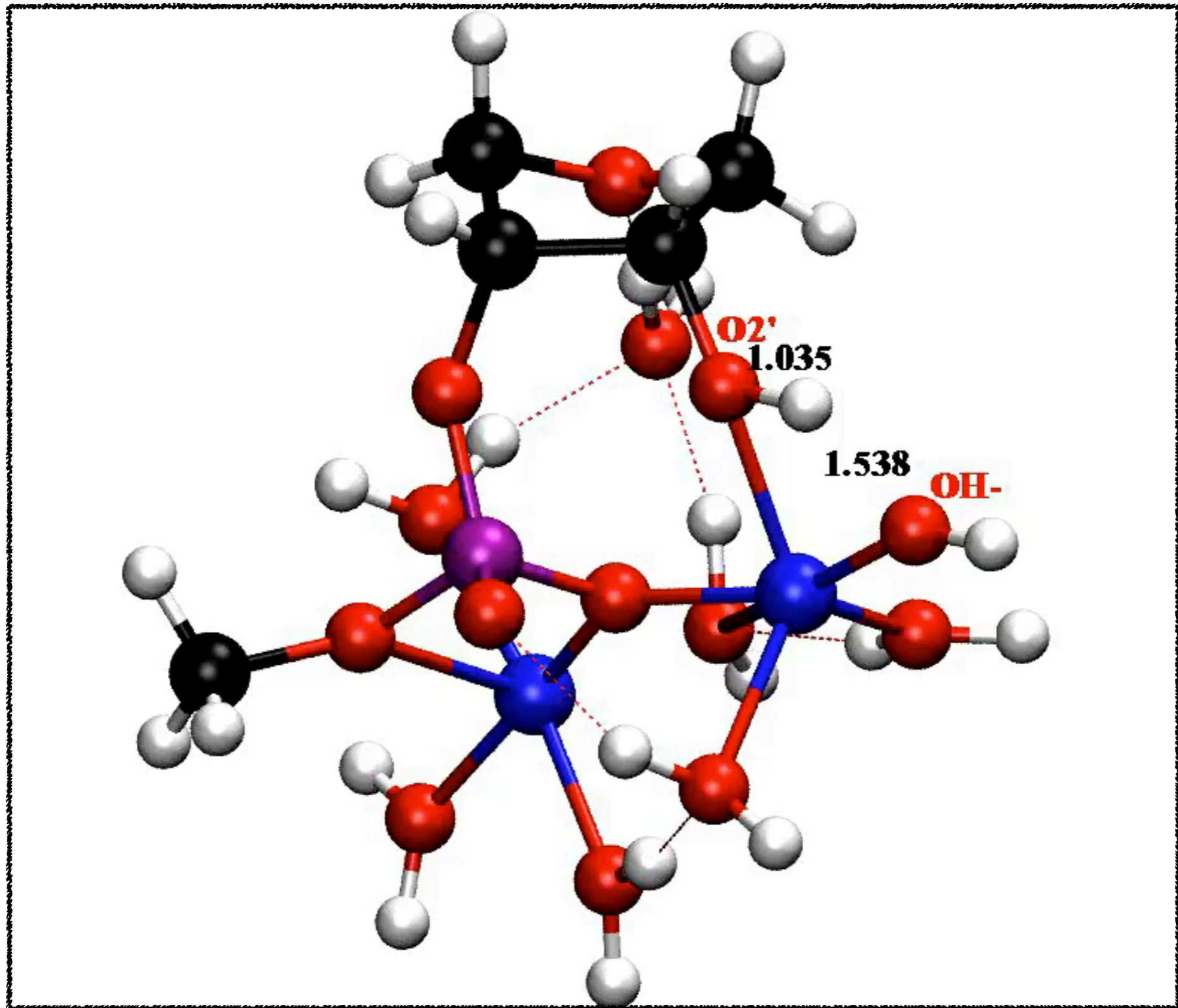

Reaction Path Following: B3LYP/6-31+G(d,p)//HF/3-21+G(d)



# Metal Binding Sites in the Hammerhead Ribozyme ?

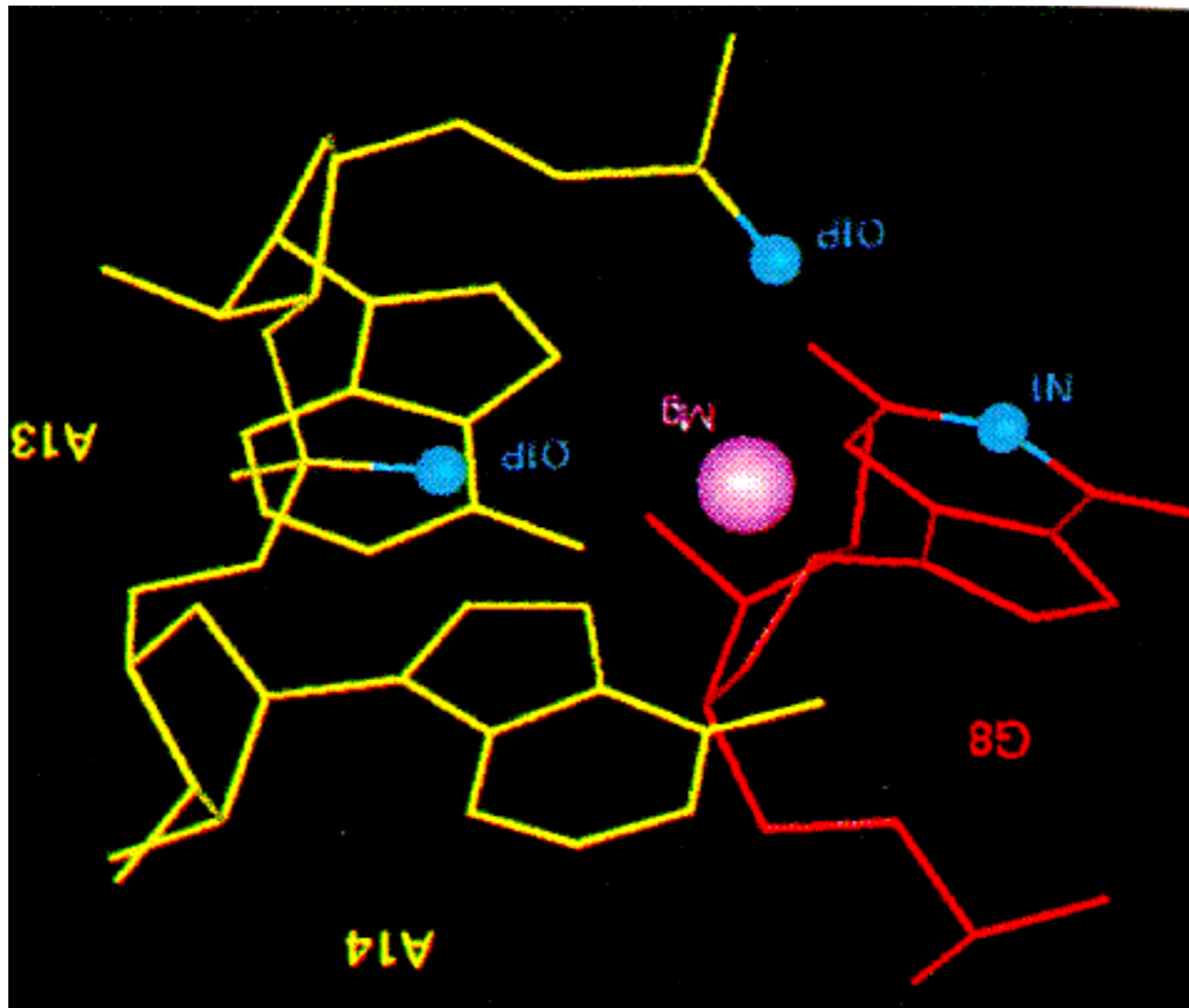

Chartrand *et al.*, RNA, 1997

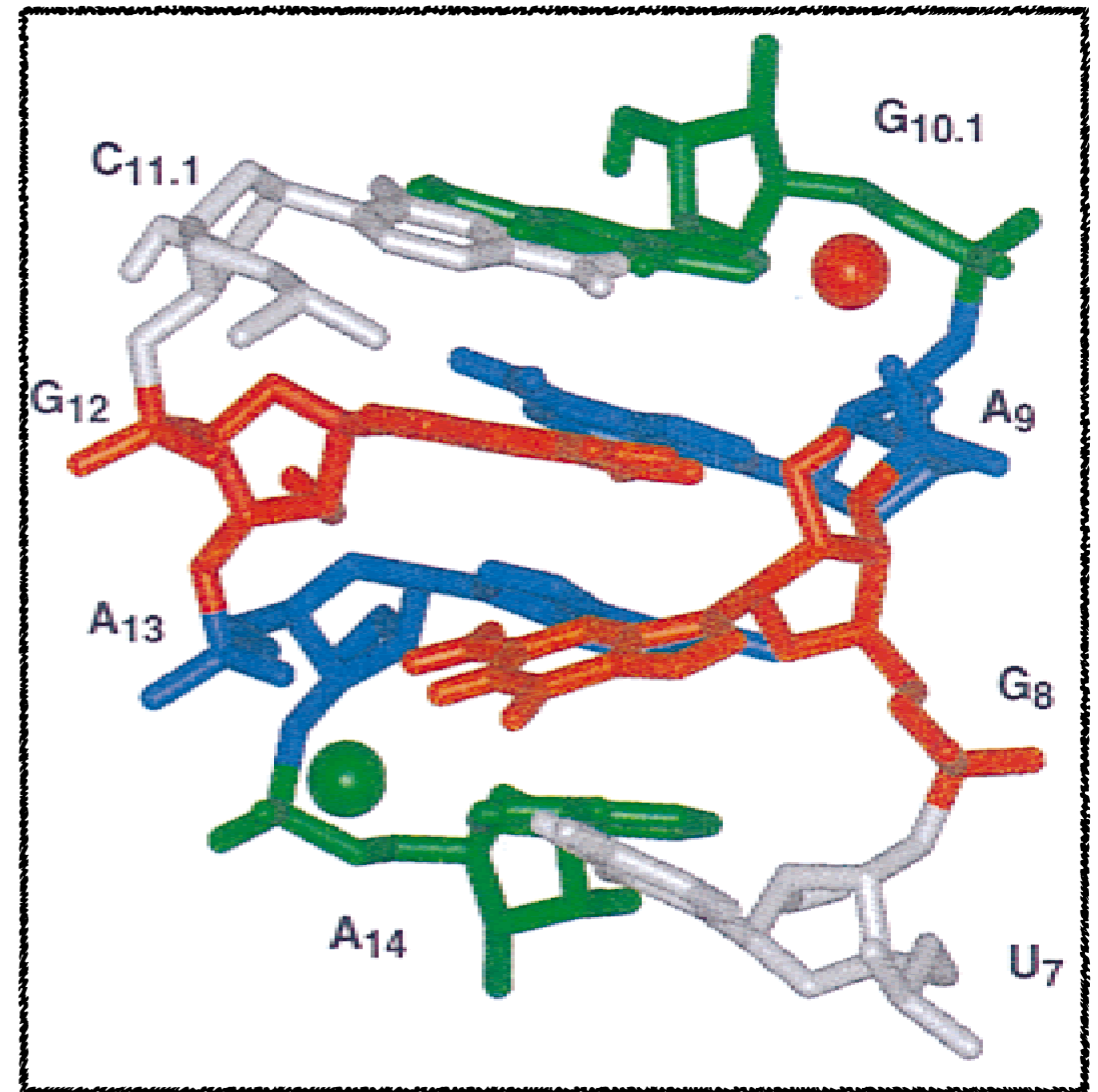

Hansen *et al.*, RNA, 2008

# Minimum/Full-Length HHR

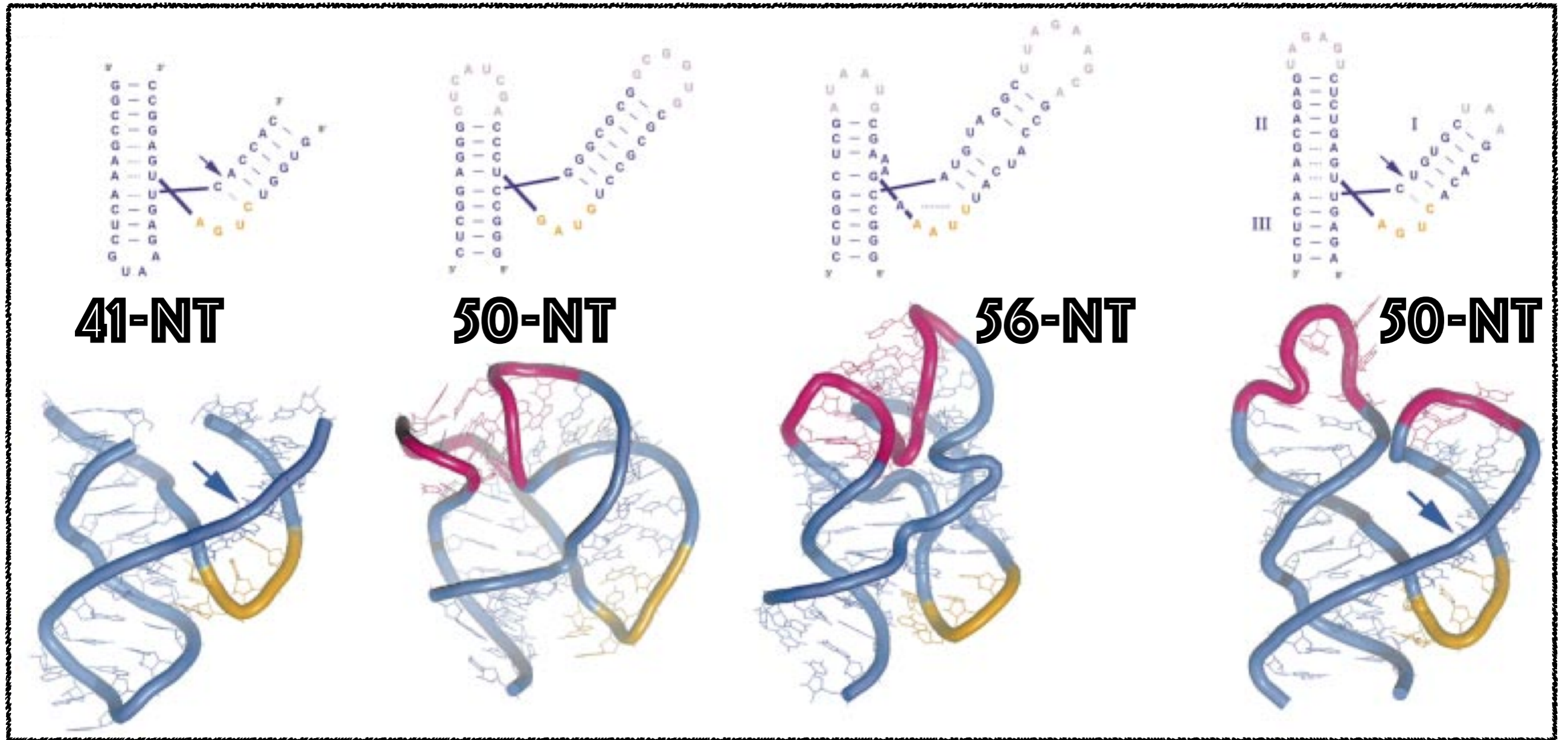

Wang *et al.*, *Biochem.*, 1999

Khvorova *et al.*, *Nat. Struct. Biol.*, 2003

de la Peña *et al.*, *EMBO J.*, 2003

Canny *et al.*, *JACS*, 2004

# Variations in HHR motifs

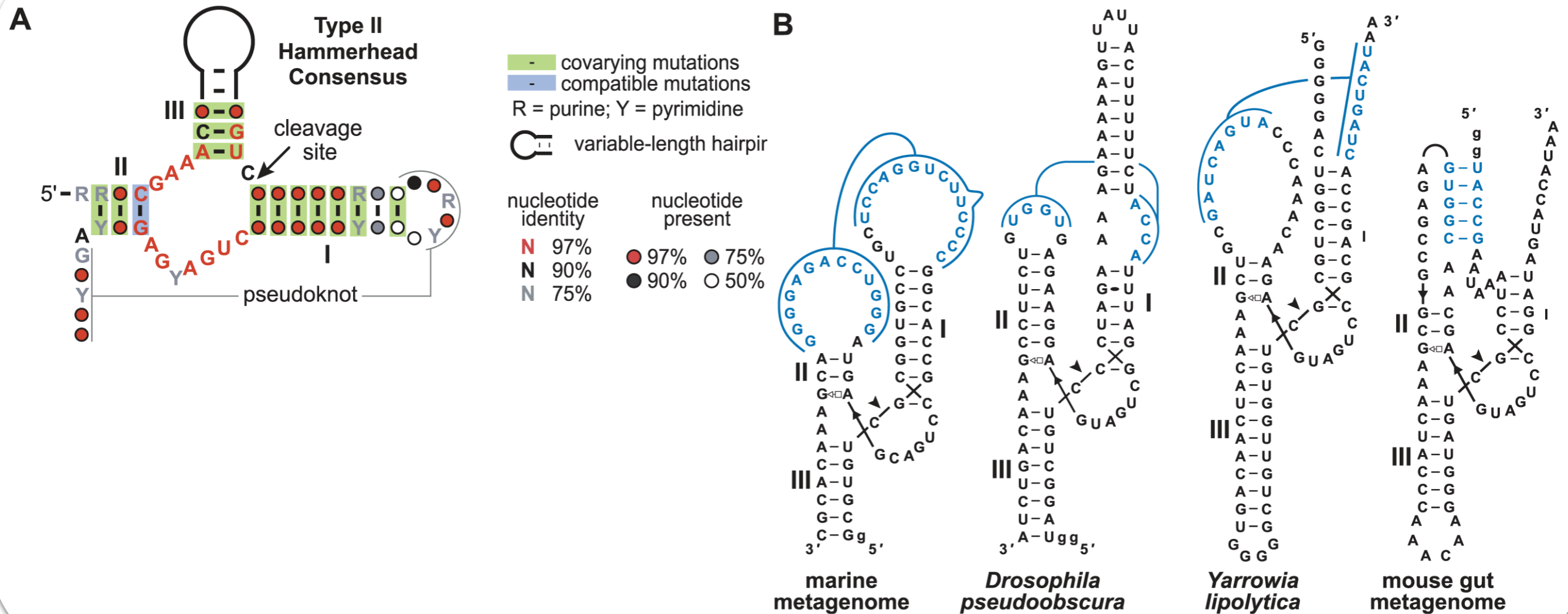

Perreault *et al.*, PLoS Comput. Biol., 2011

# Loop-Loop interactions in HHR folding

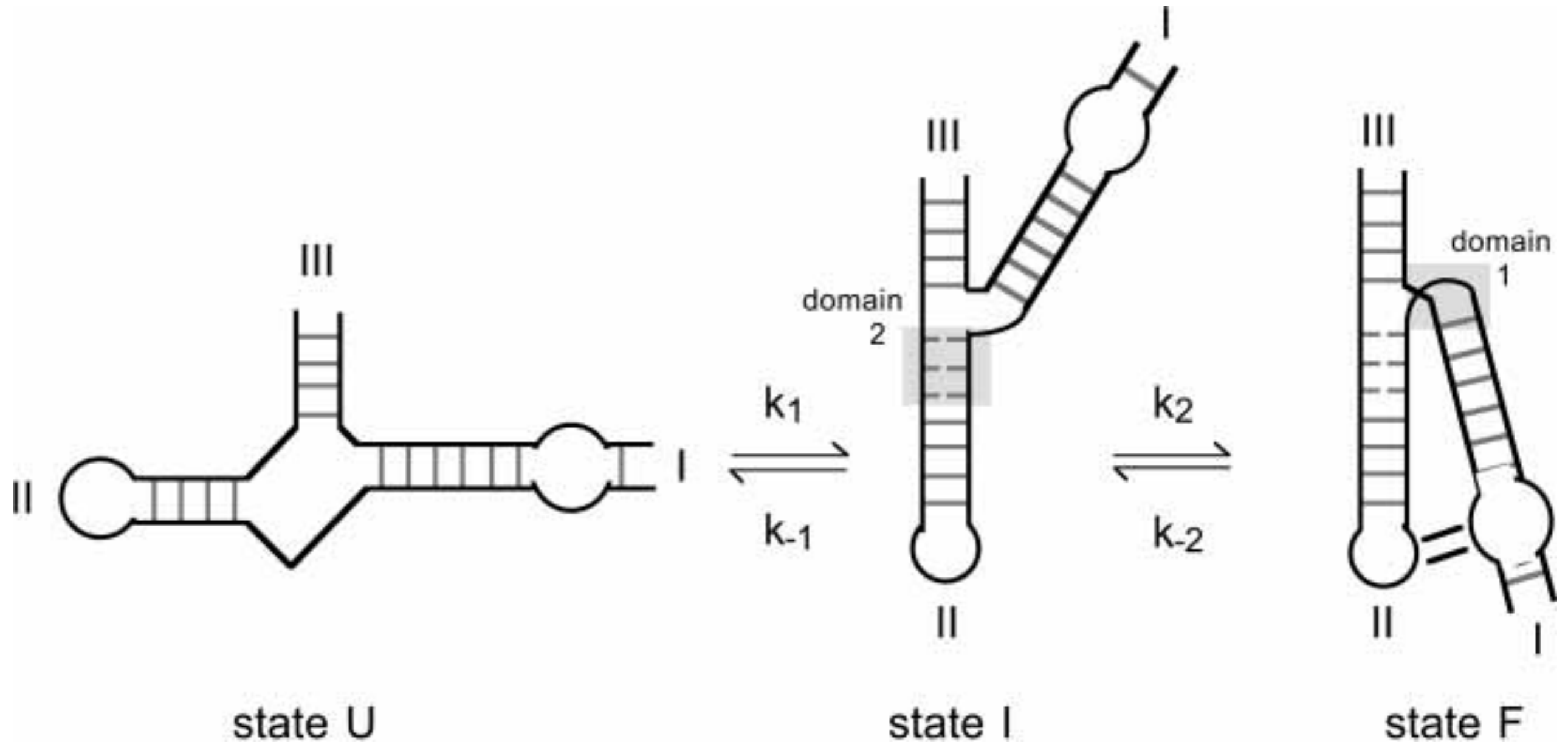

Penedo *et al.*, RNA, 2004.

# Loop-Loop interactions in HHR catalysis

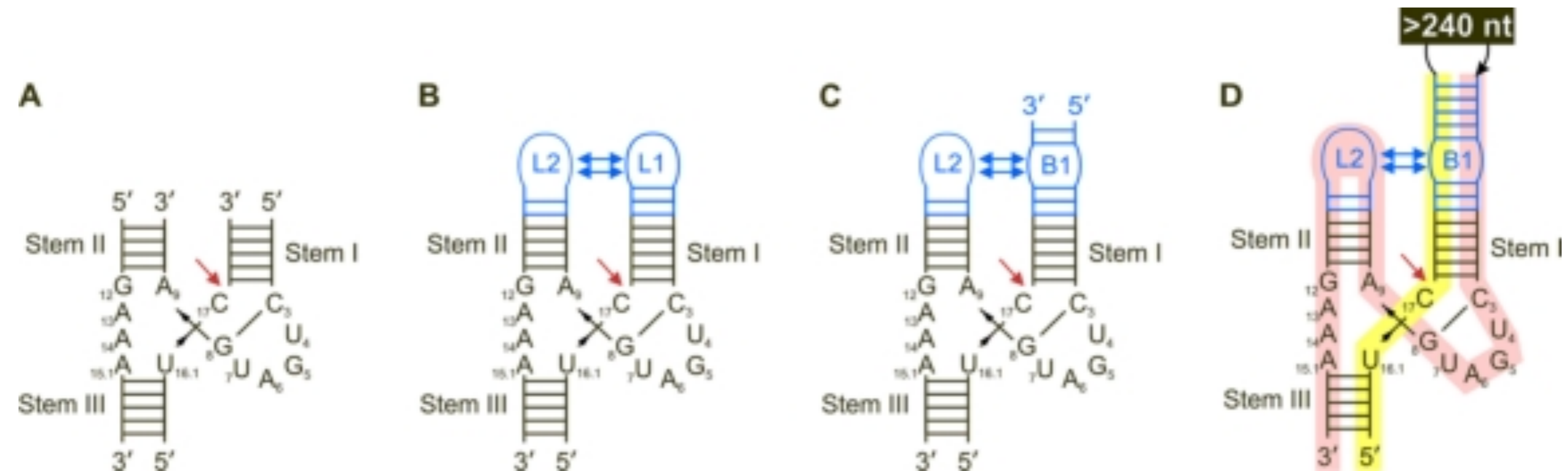

# Minimum HHR, Tertiary Contact and Catalysis

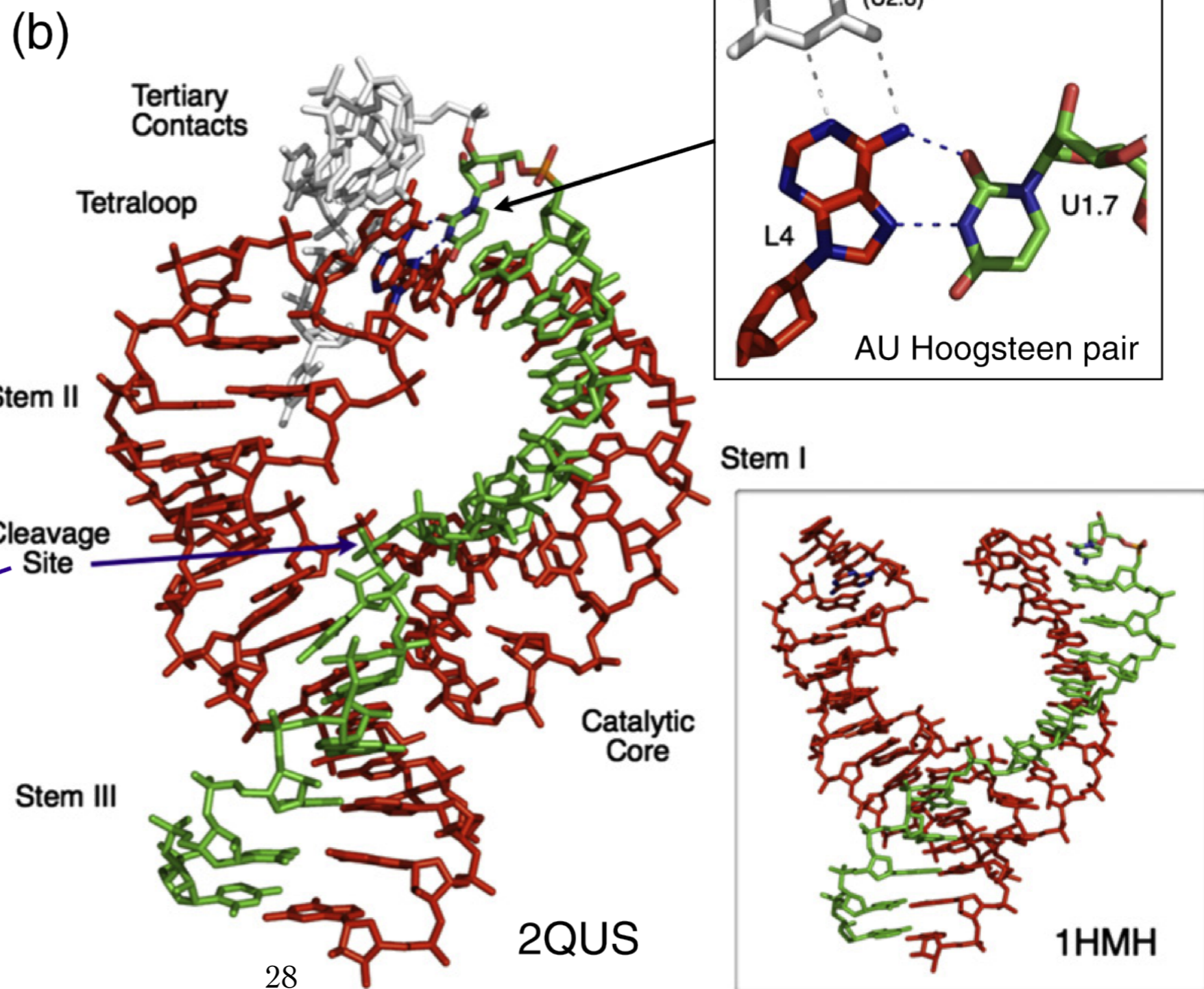
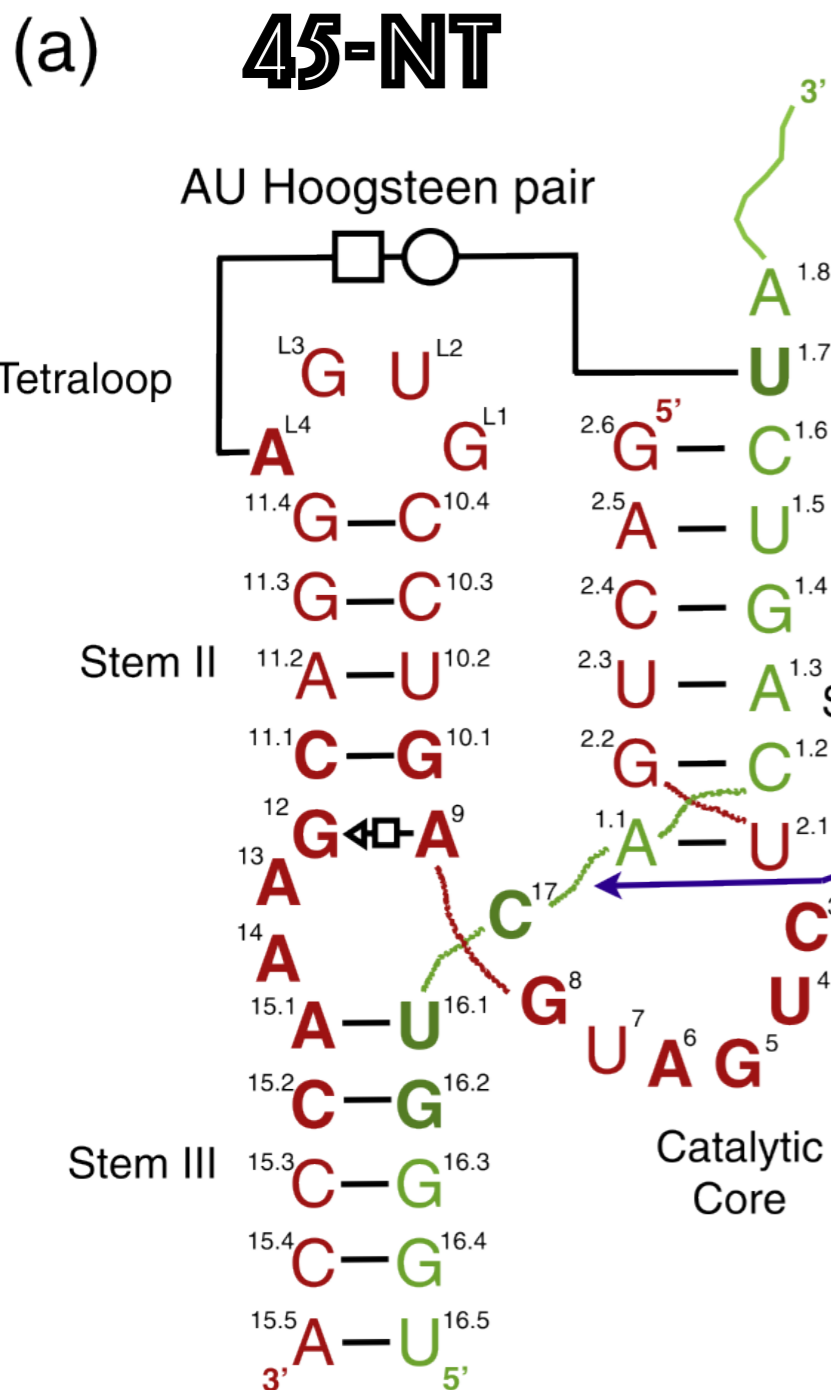

# HHR morphing

Highly active  
form

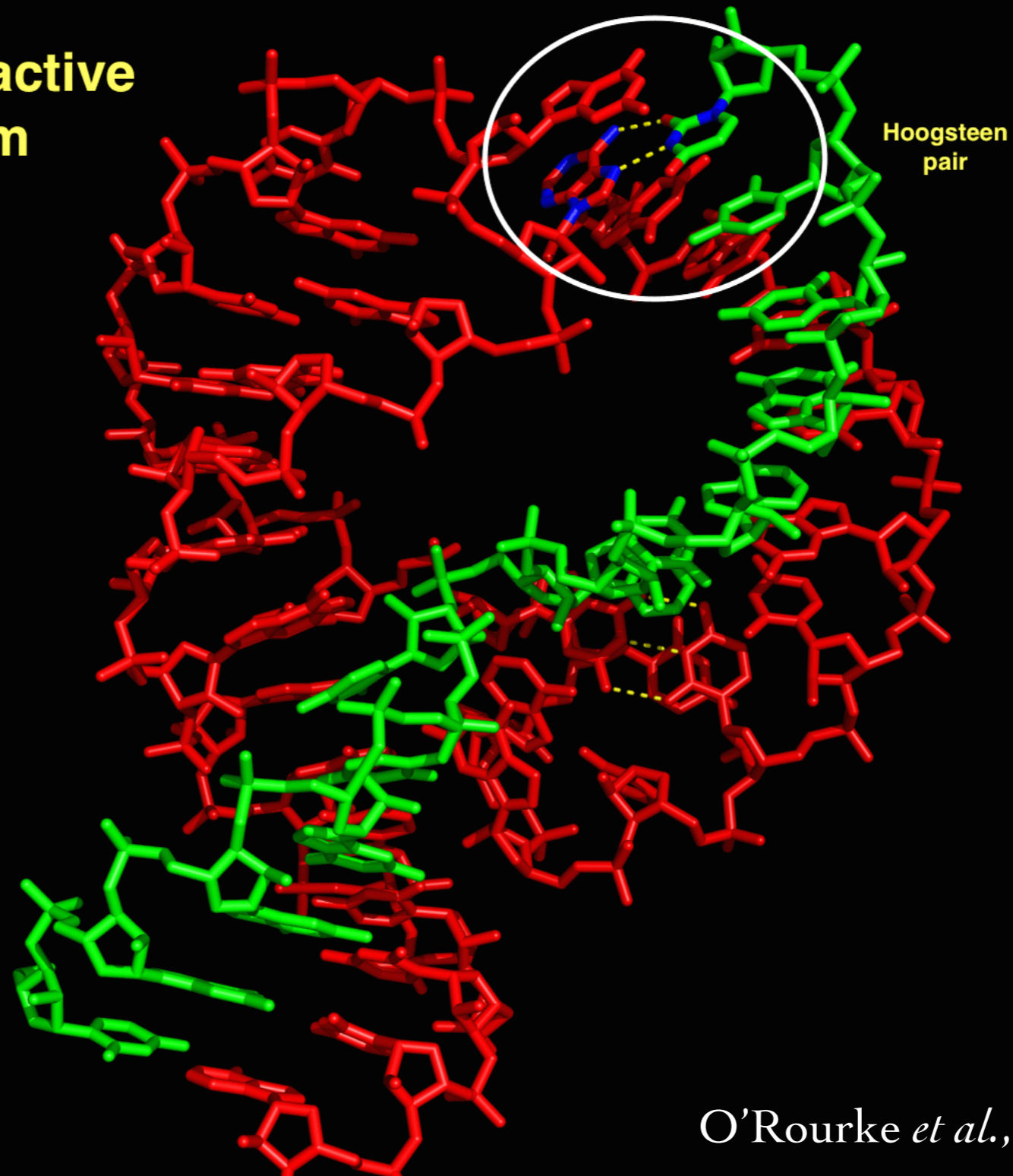

O'Rourke *et al.*, JMB, 2015

# A Nucleobase Catalyst

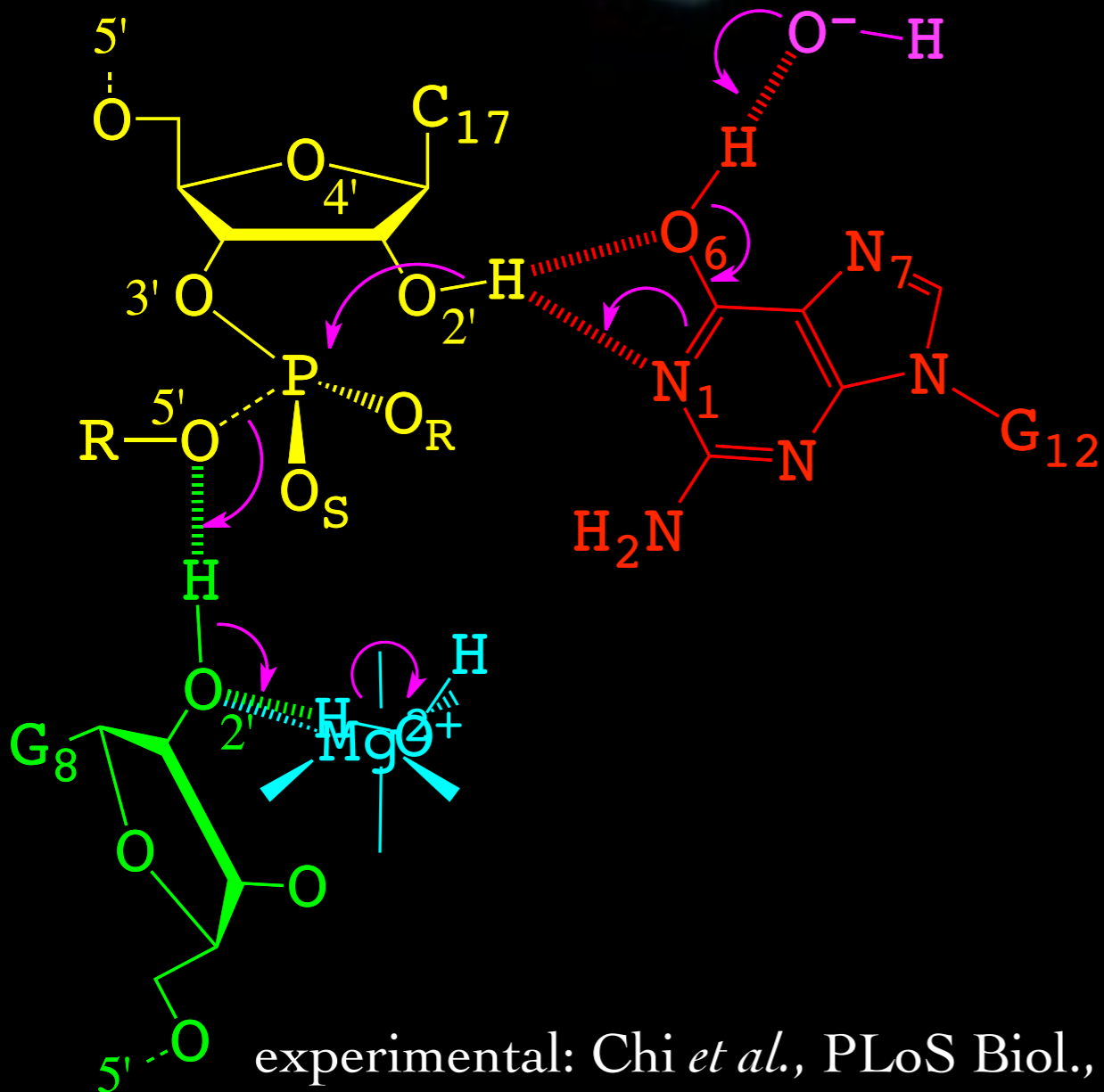
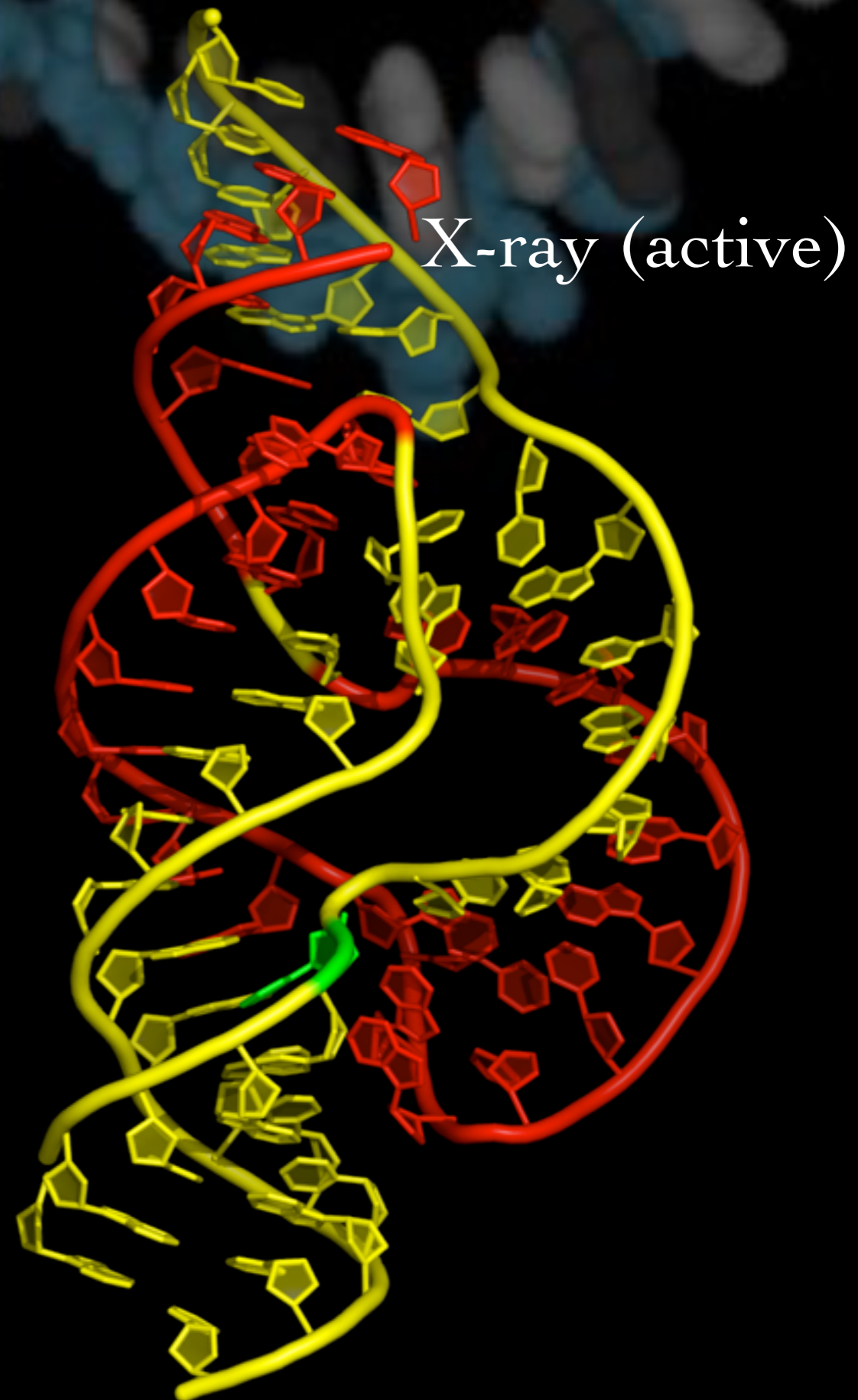

experimental: Chi *et al.*, PLoS Biol., 2008

theoretical: Lee *et al.*, JACS, 2008 30

# Metal Catalysts in the 2'OH activation ?

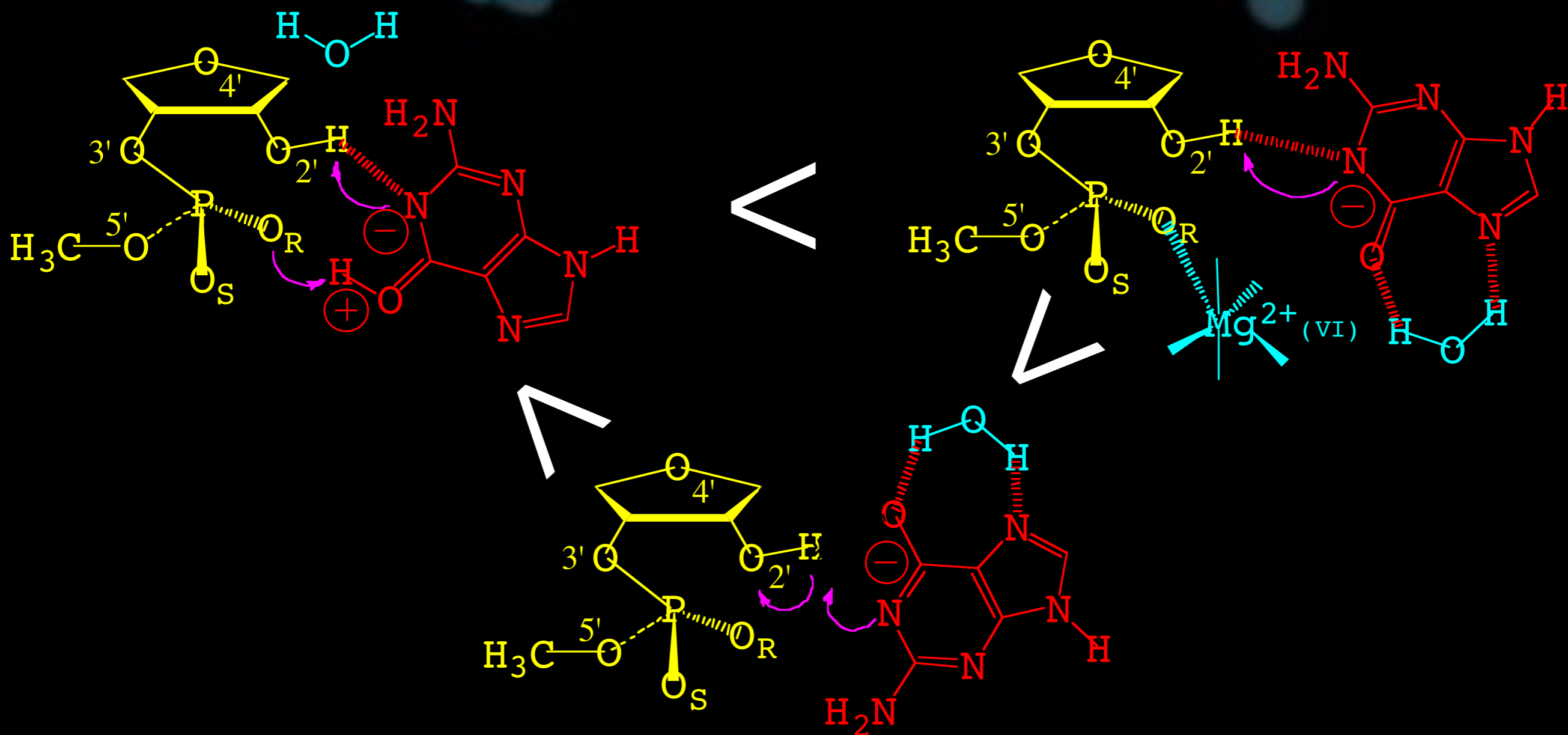

# Metal Catalysts in the Hammerhead Ribozymes ?

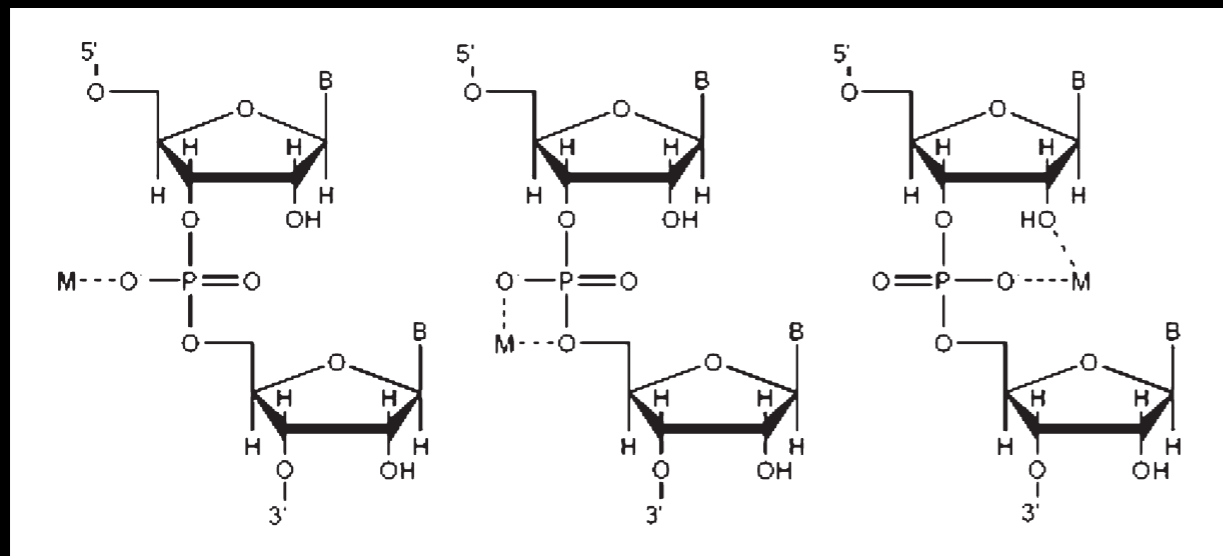
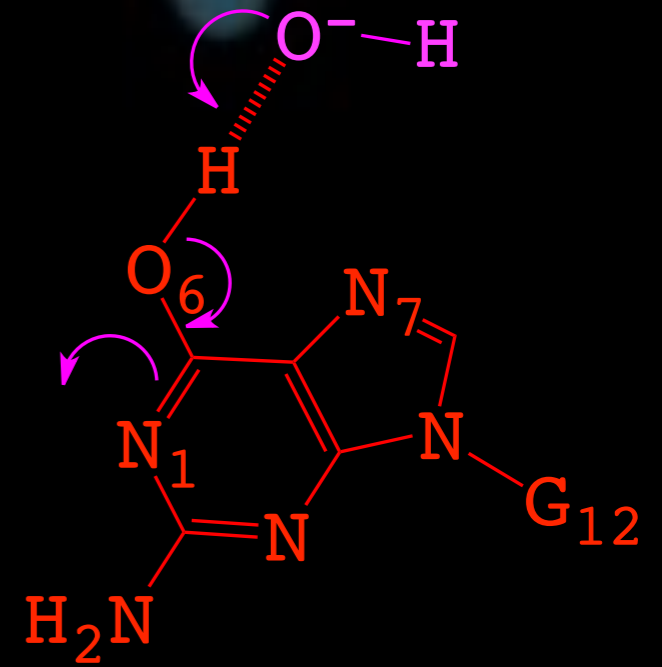
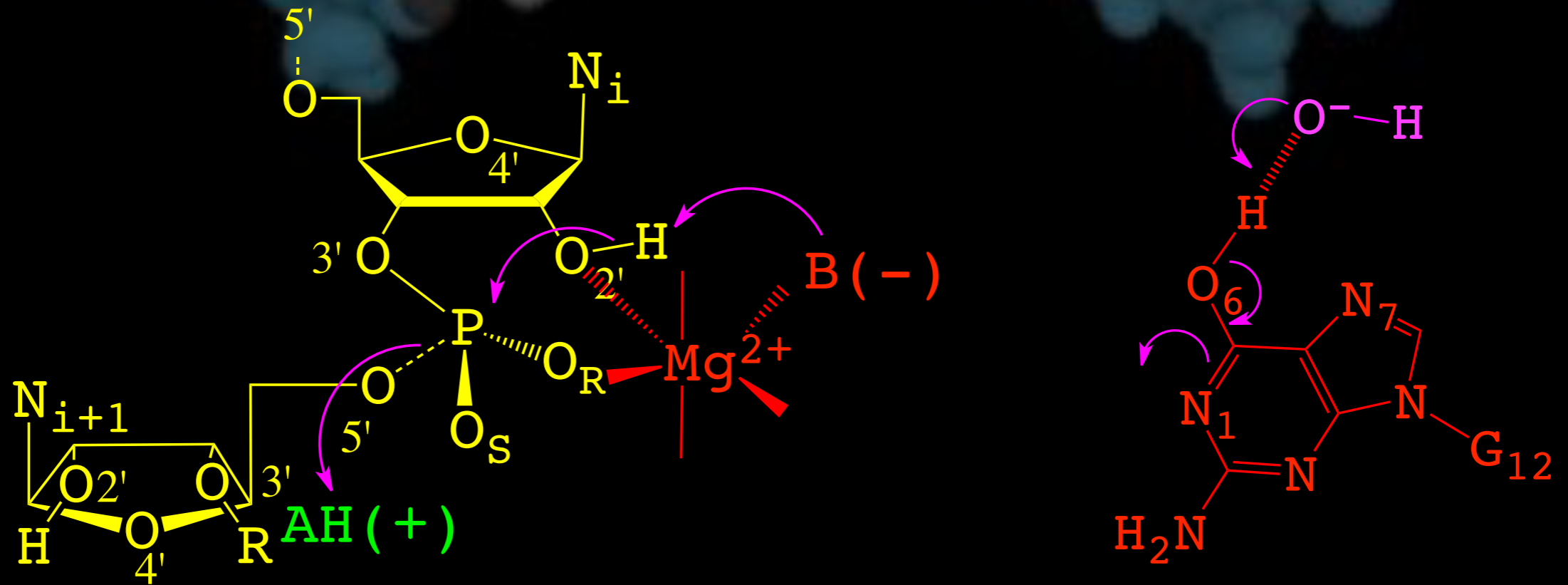

Osborne *et al.*, Biochem., 2009

# Cooperative Models in Self-Cleaving ?

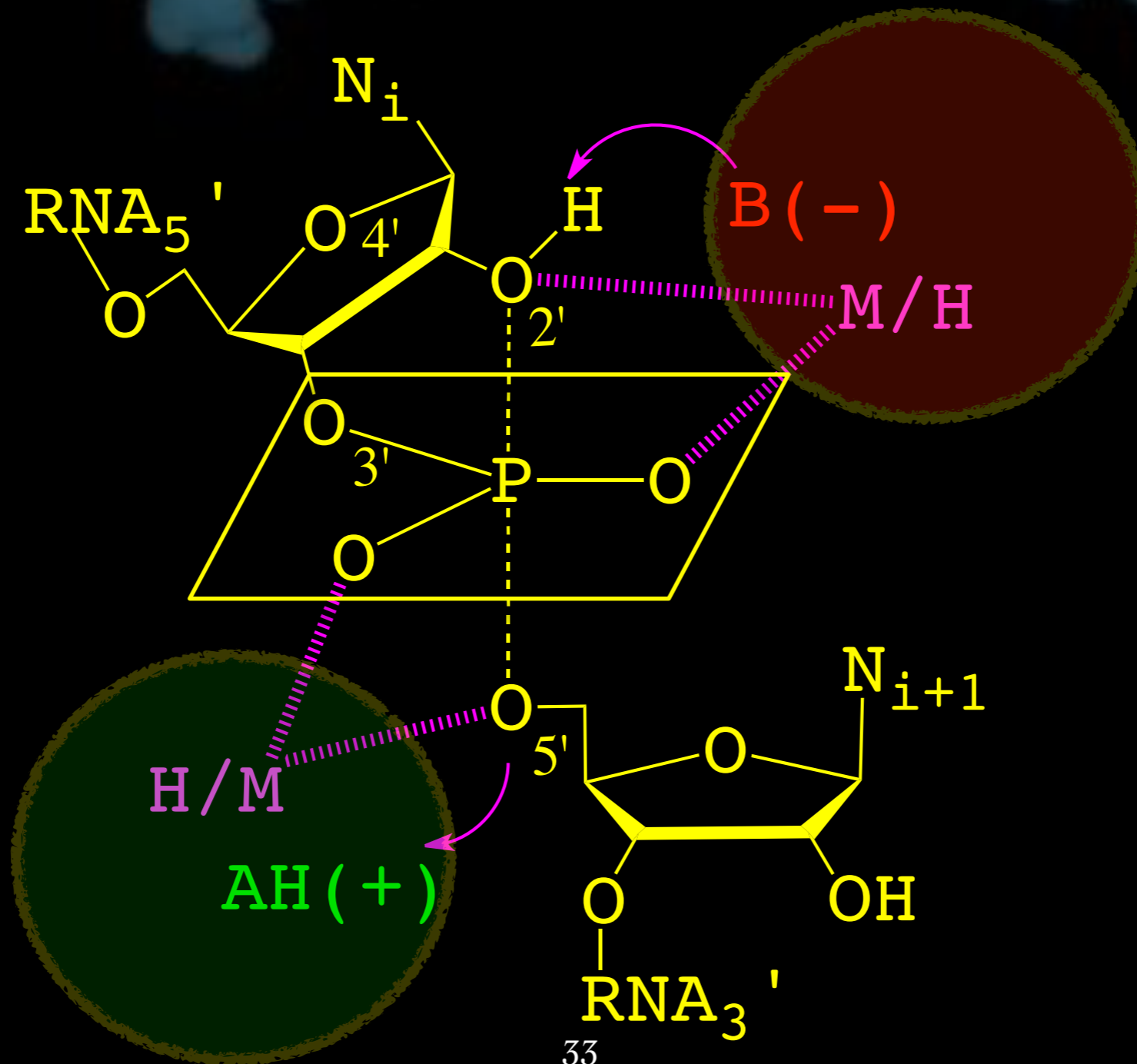

# Cooperative Models in Self-Cleaving ?

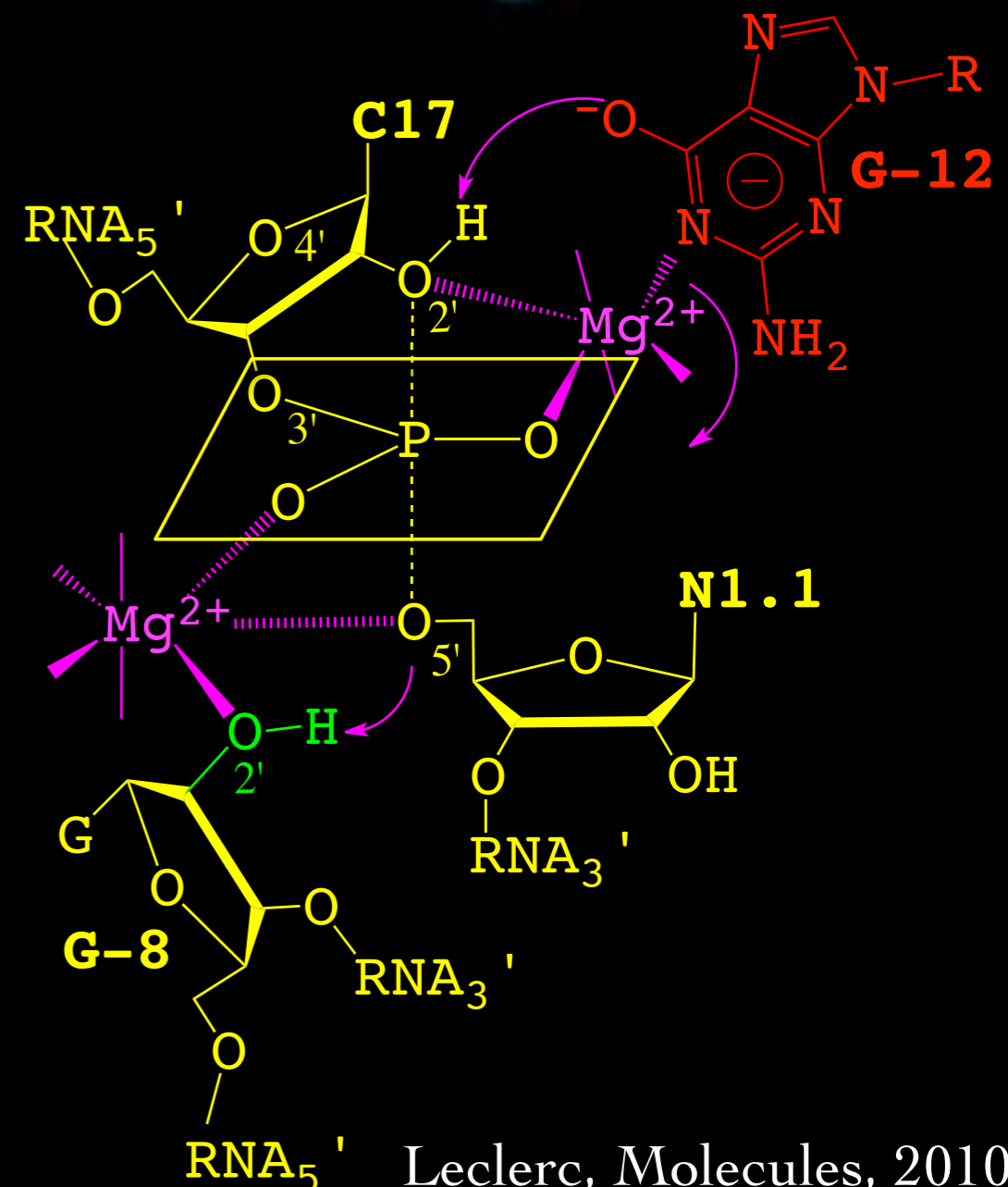
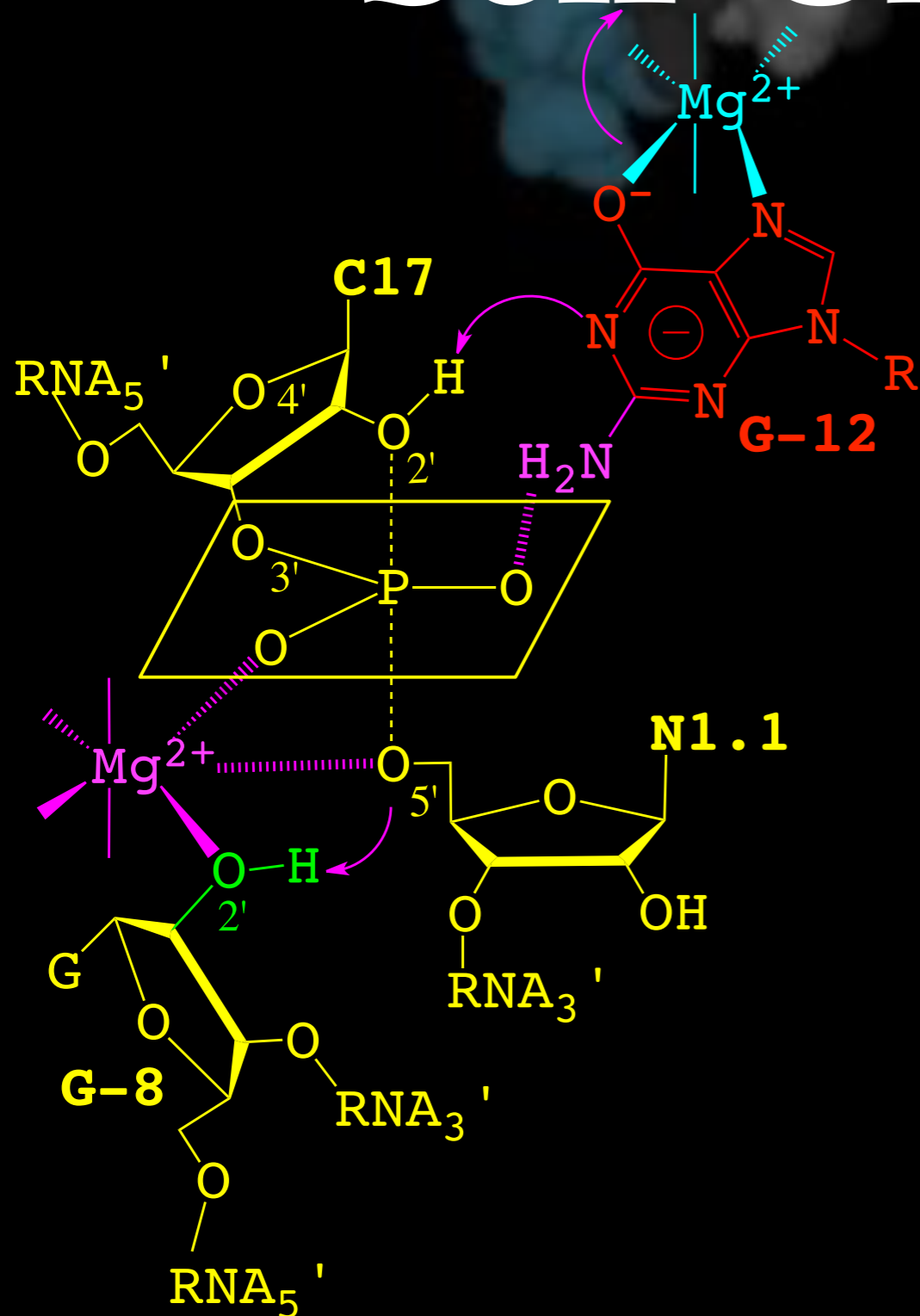

# Metal Ions back in the Hammerhead Catalysis

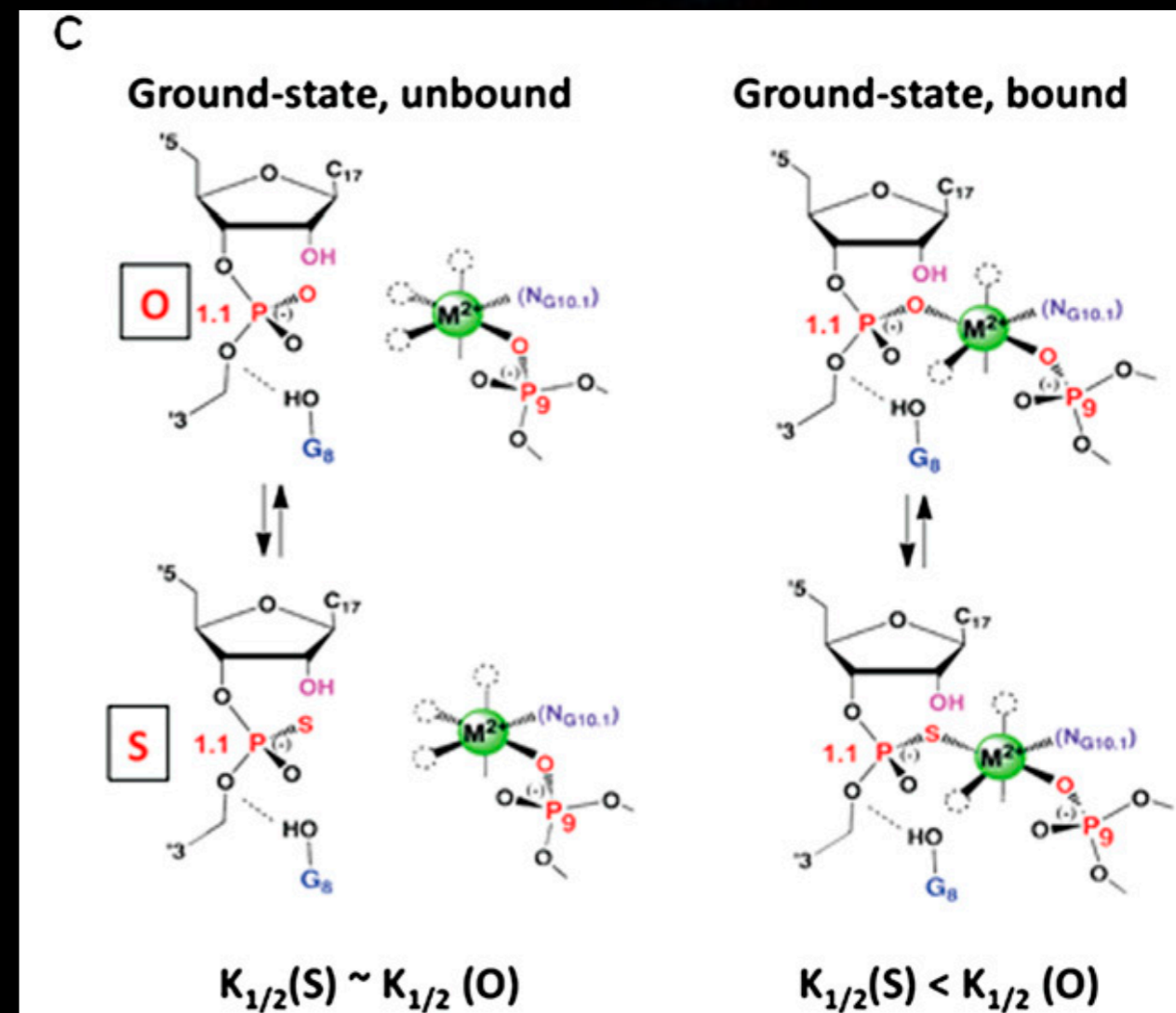
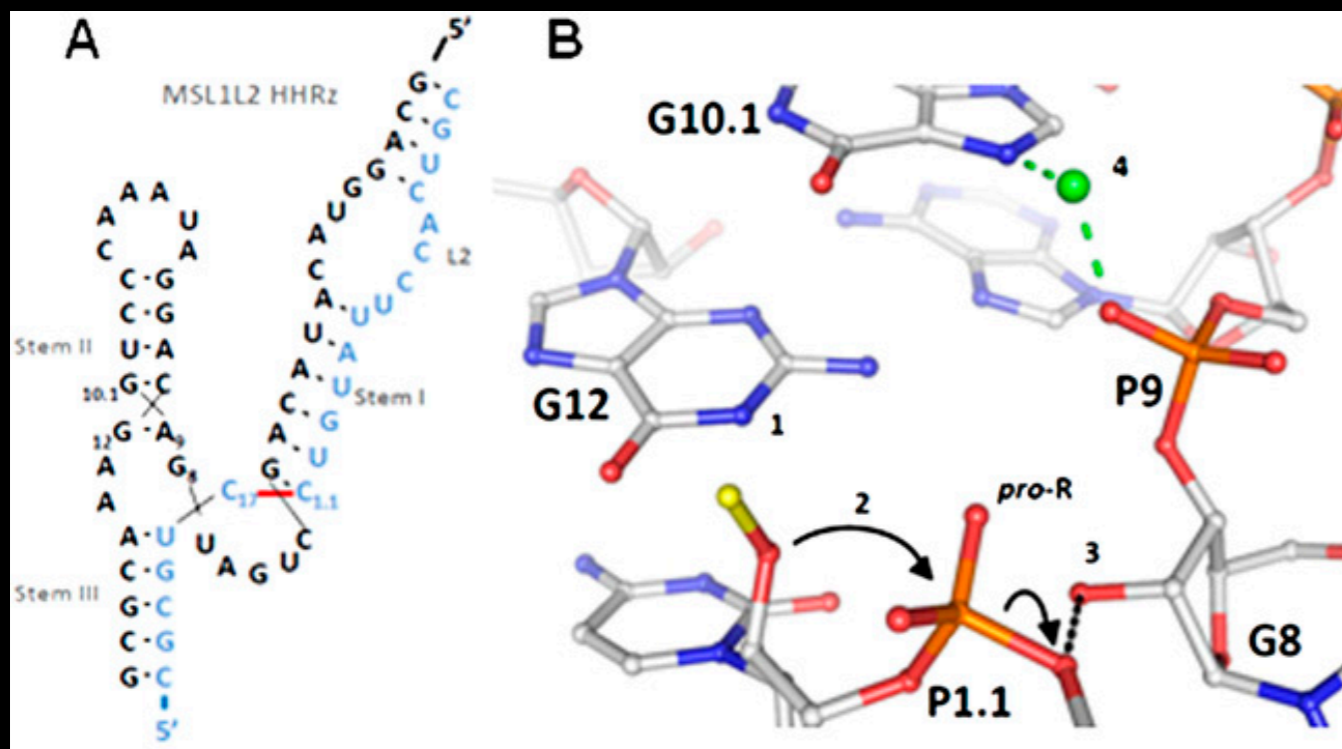

Ward & DeRose, RNA, 2011

# HHH: Active Conformation and Metal Ions

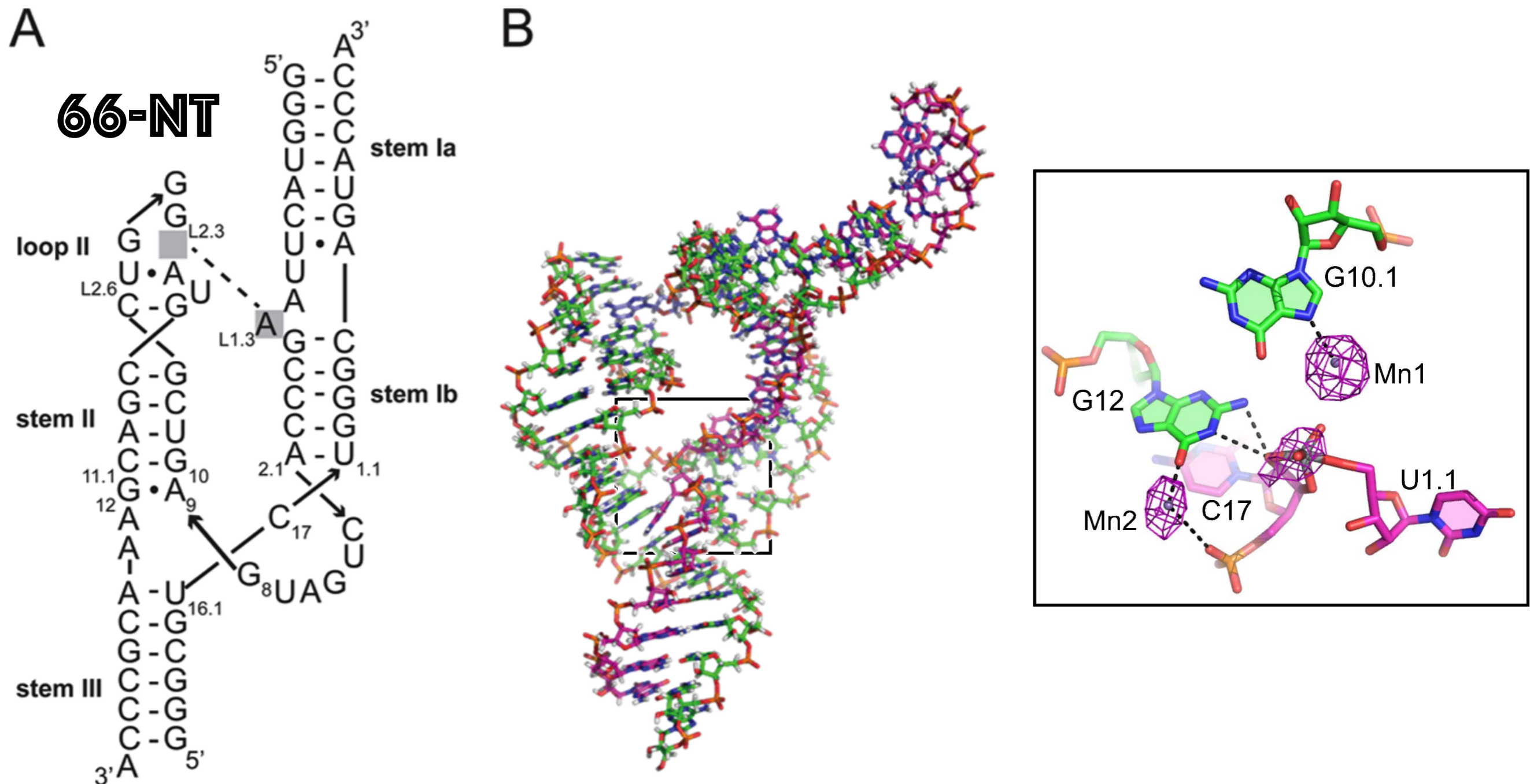

# HHR: Metal Ions and Catalysis

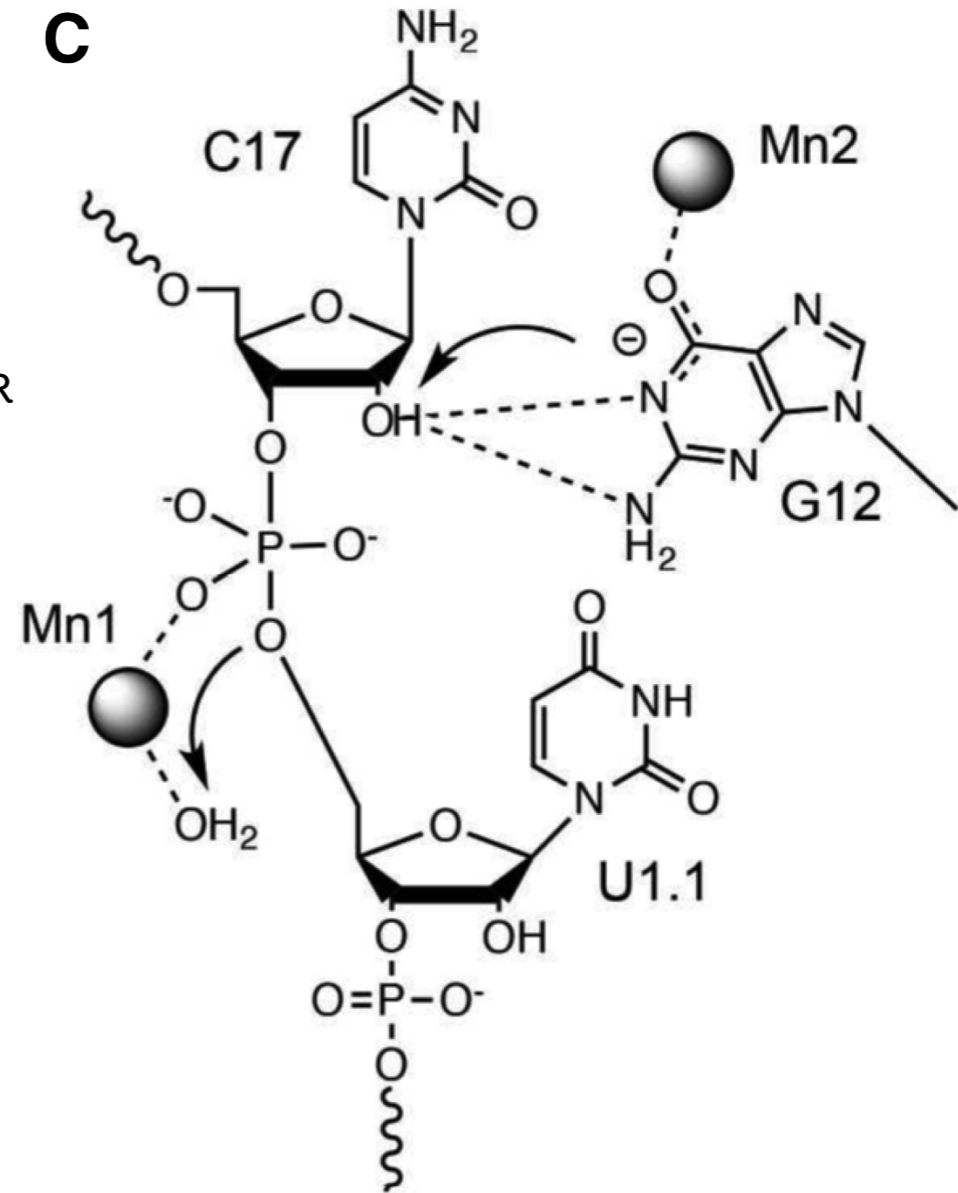
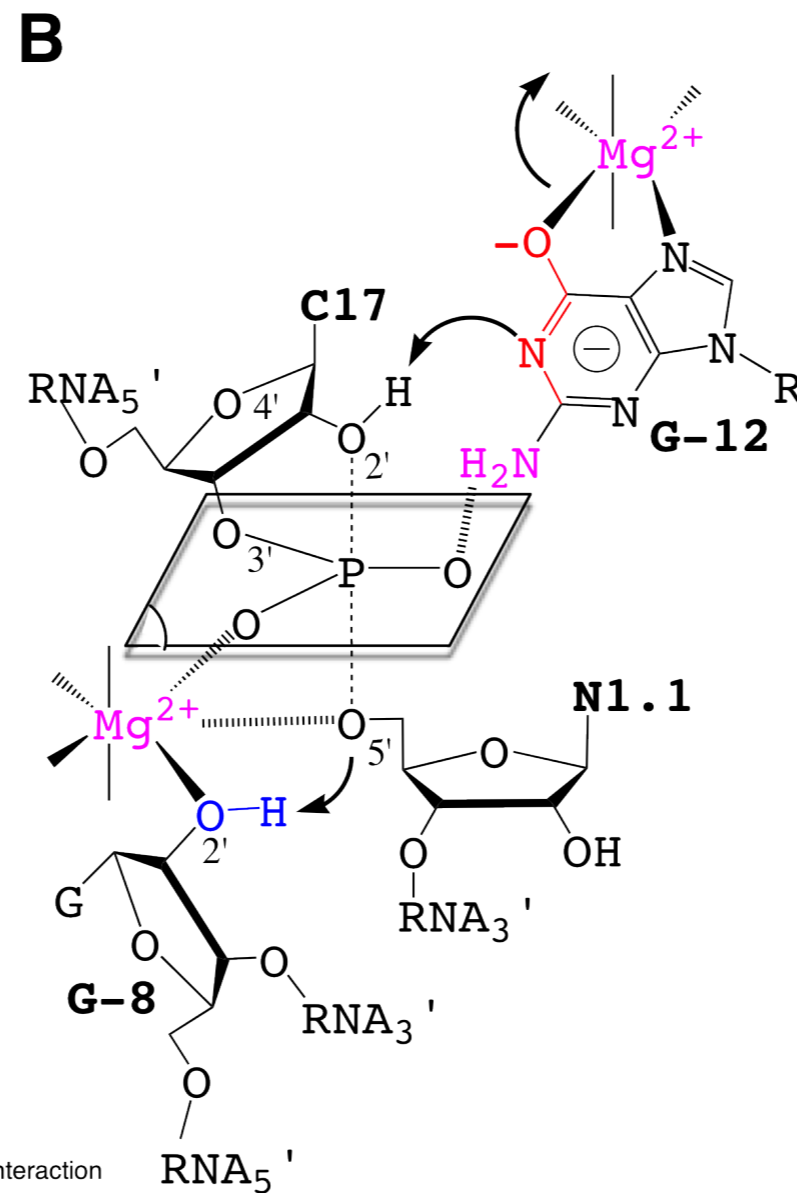
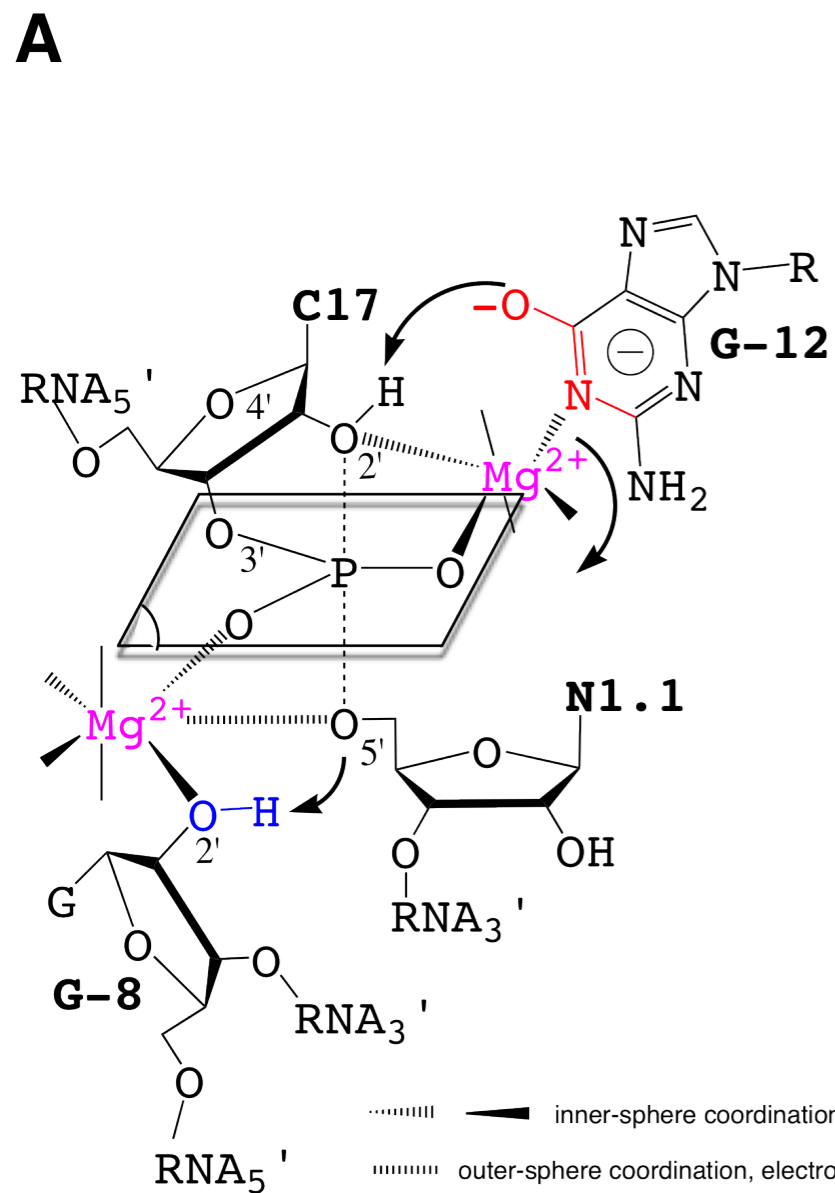

# ASBVd(-)/HHR(-): SANS

## Study

ASBVd(-)

HHR(-)

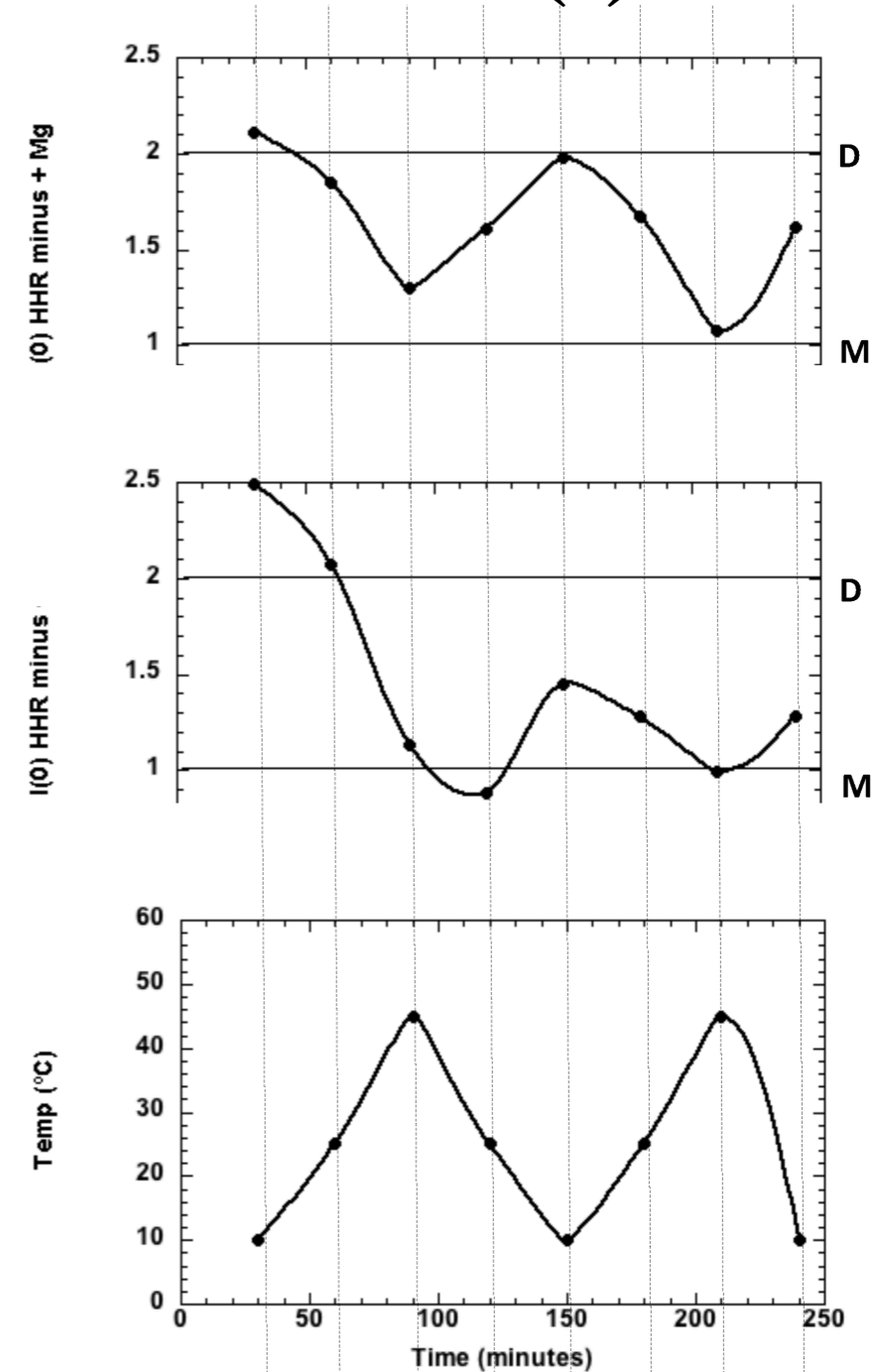
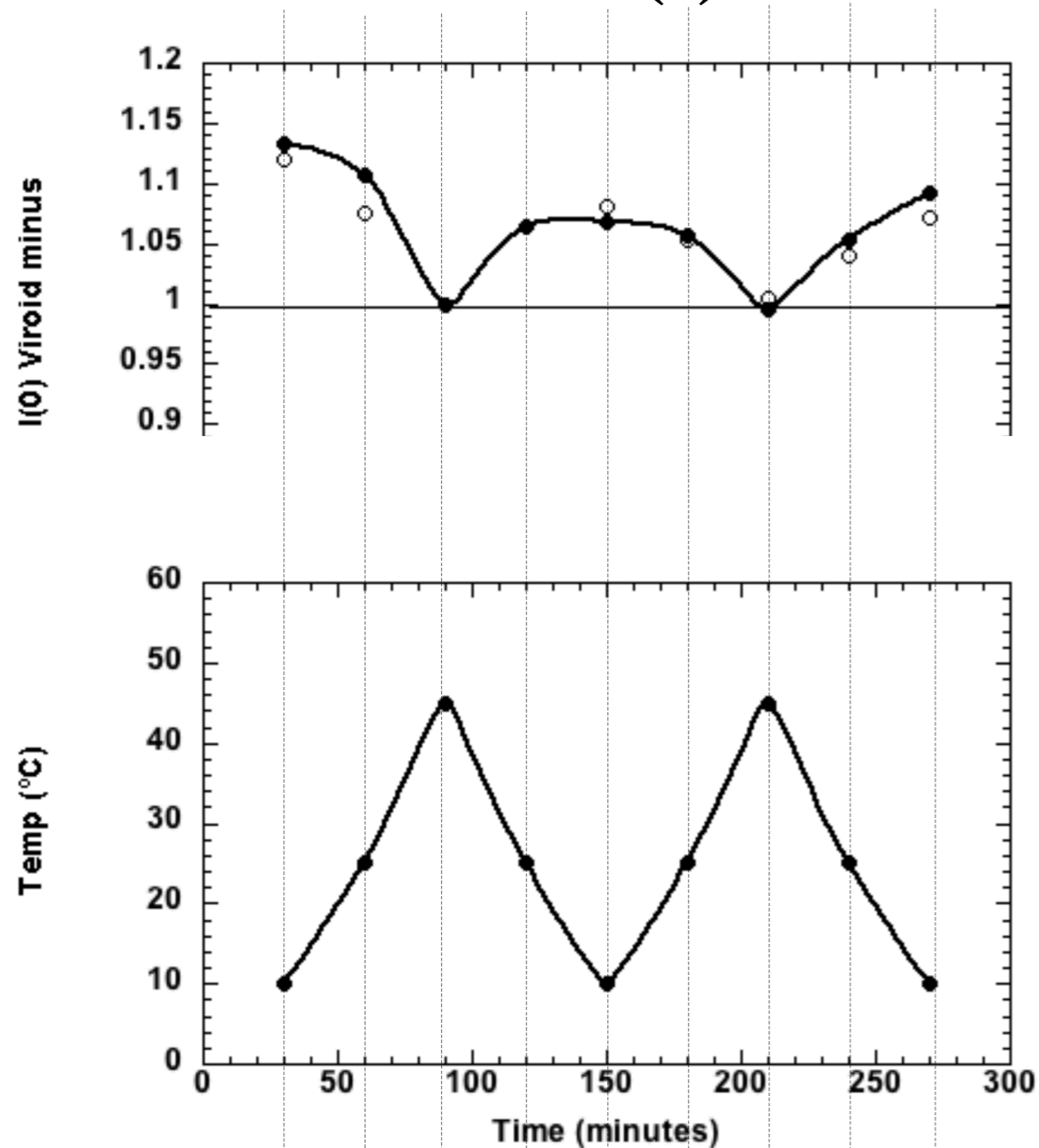

# HHR(-) dimerization/ catalysis

$E_a \sim 8\text{kcal/mol}$

$E_a \sim 6\text{kcal/mol}$

$E_a \sim 20\text{kcal/mol}$

$E_a \sim 30\text{kcal/mol}$

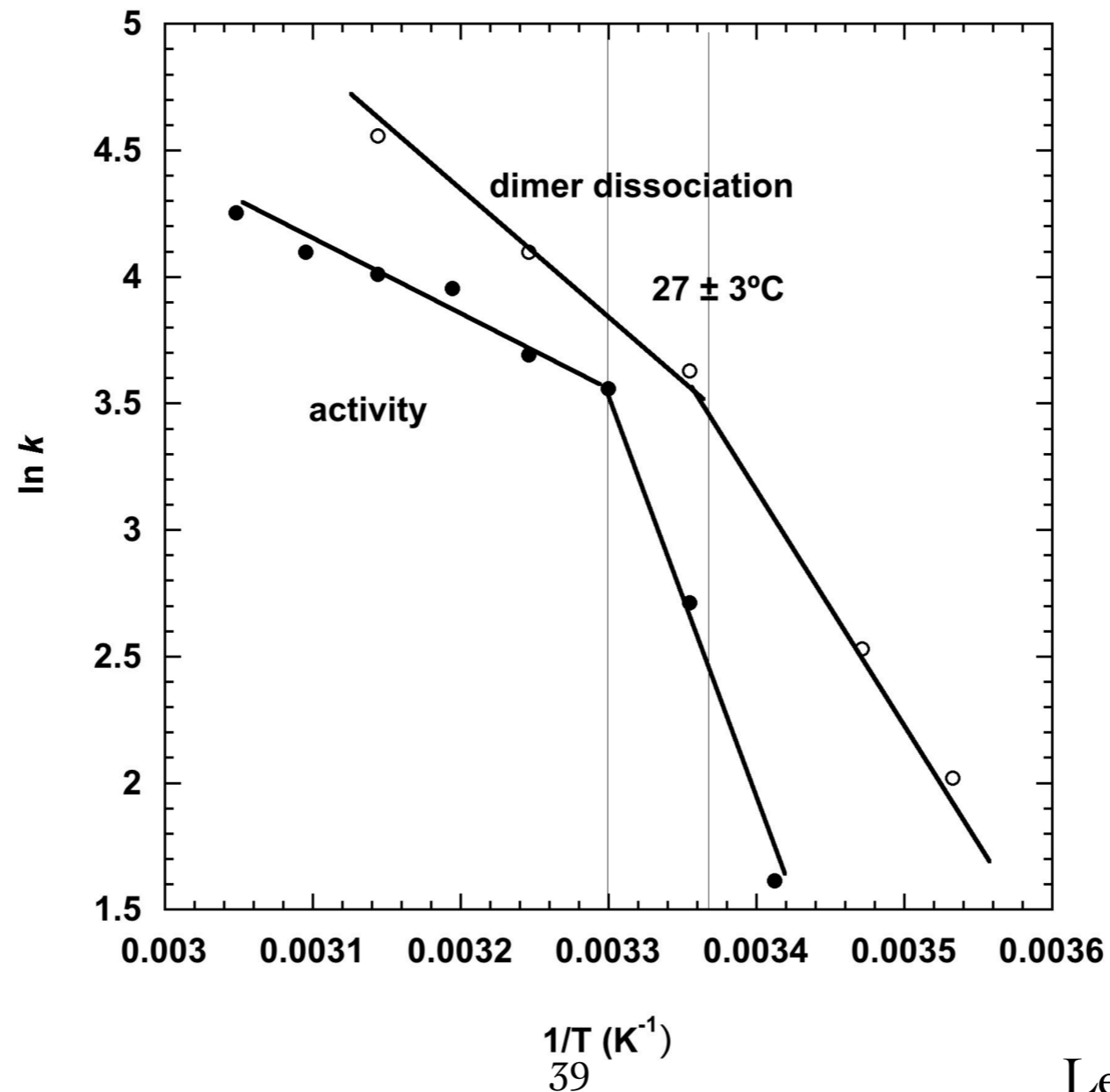

# HHR(-): 2D structures

**A**

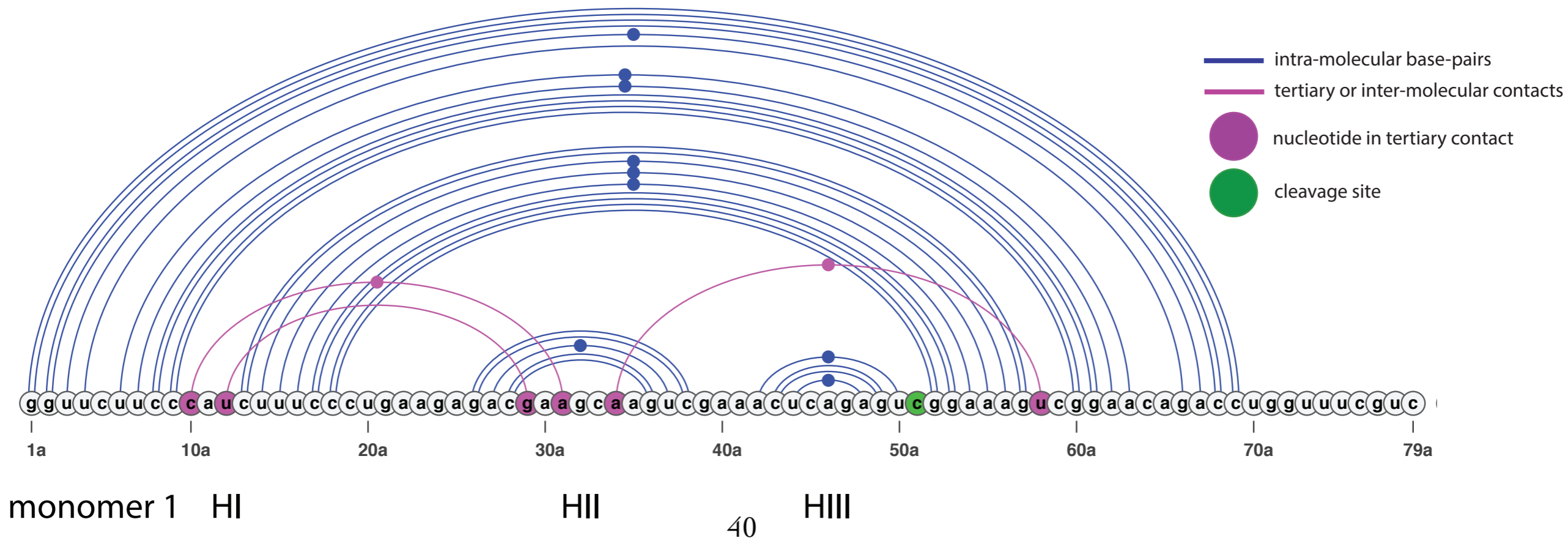
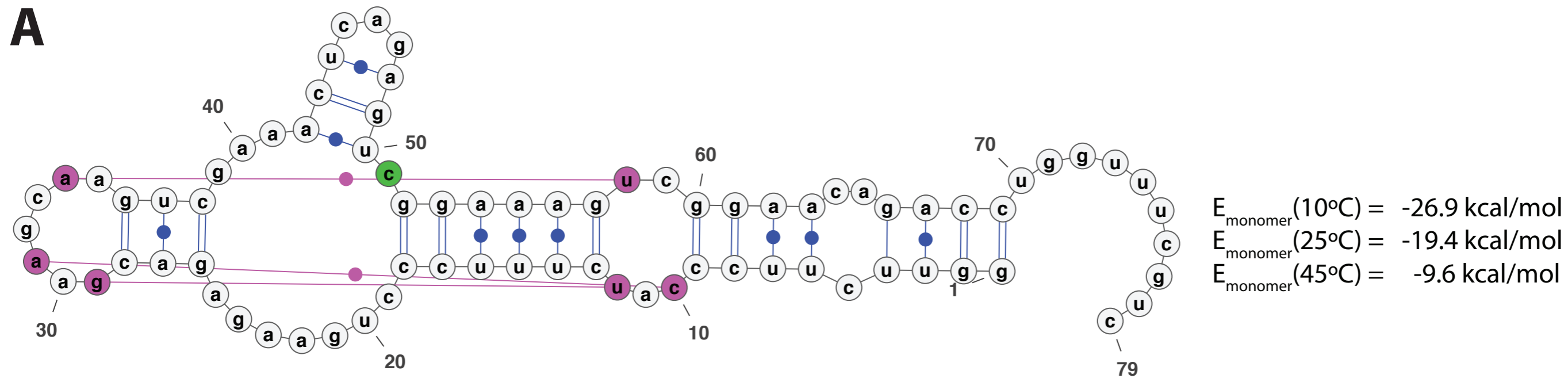

# 3D Modeling of HHR(-)

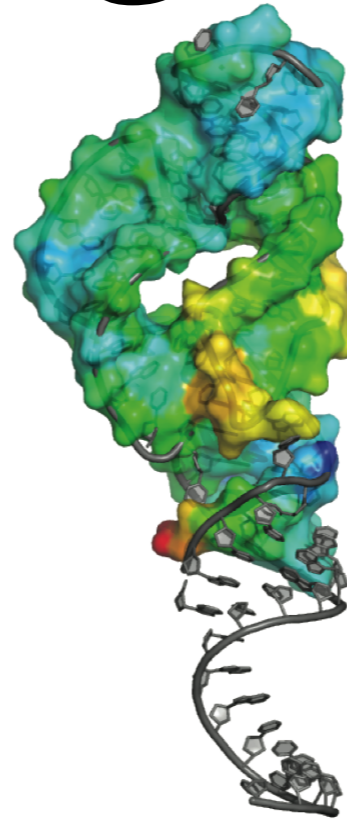
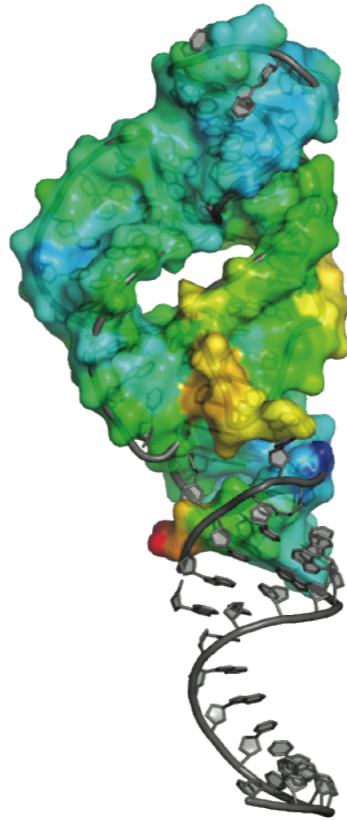
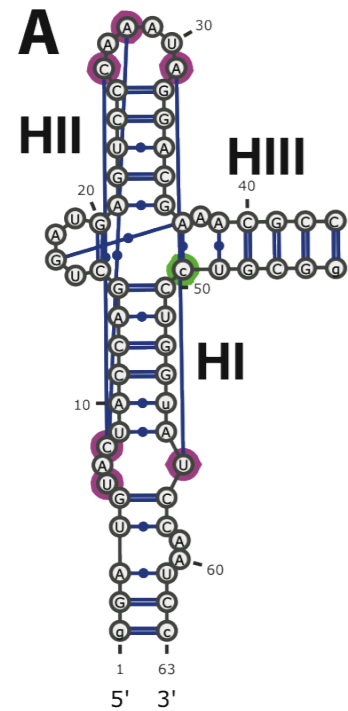

loops HI-HIII

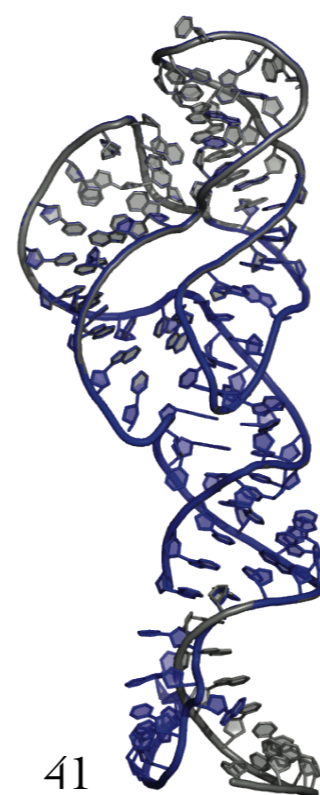
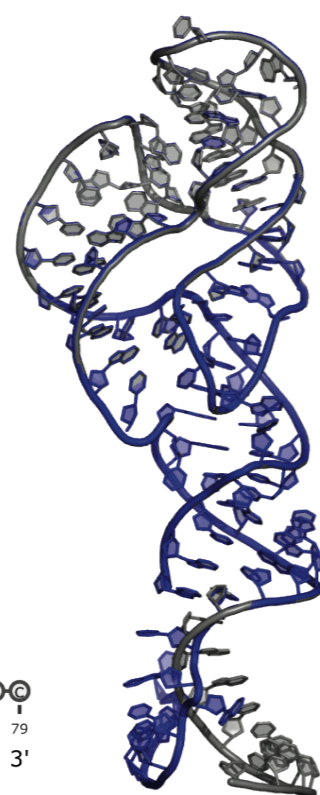
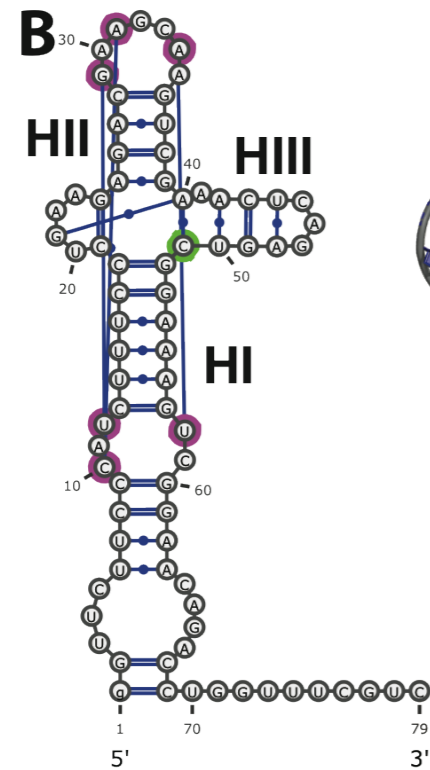
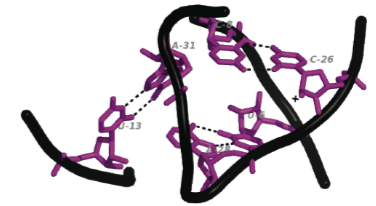
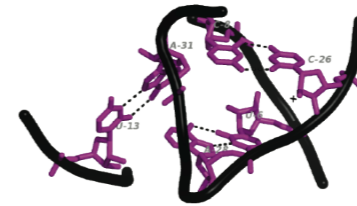

# HHR folding

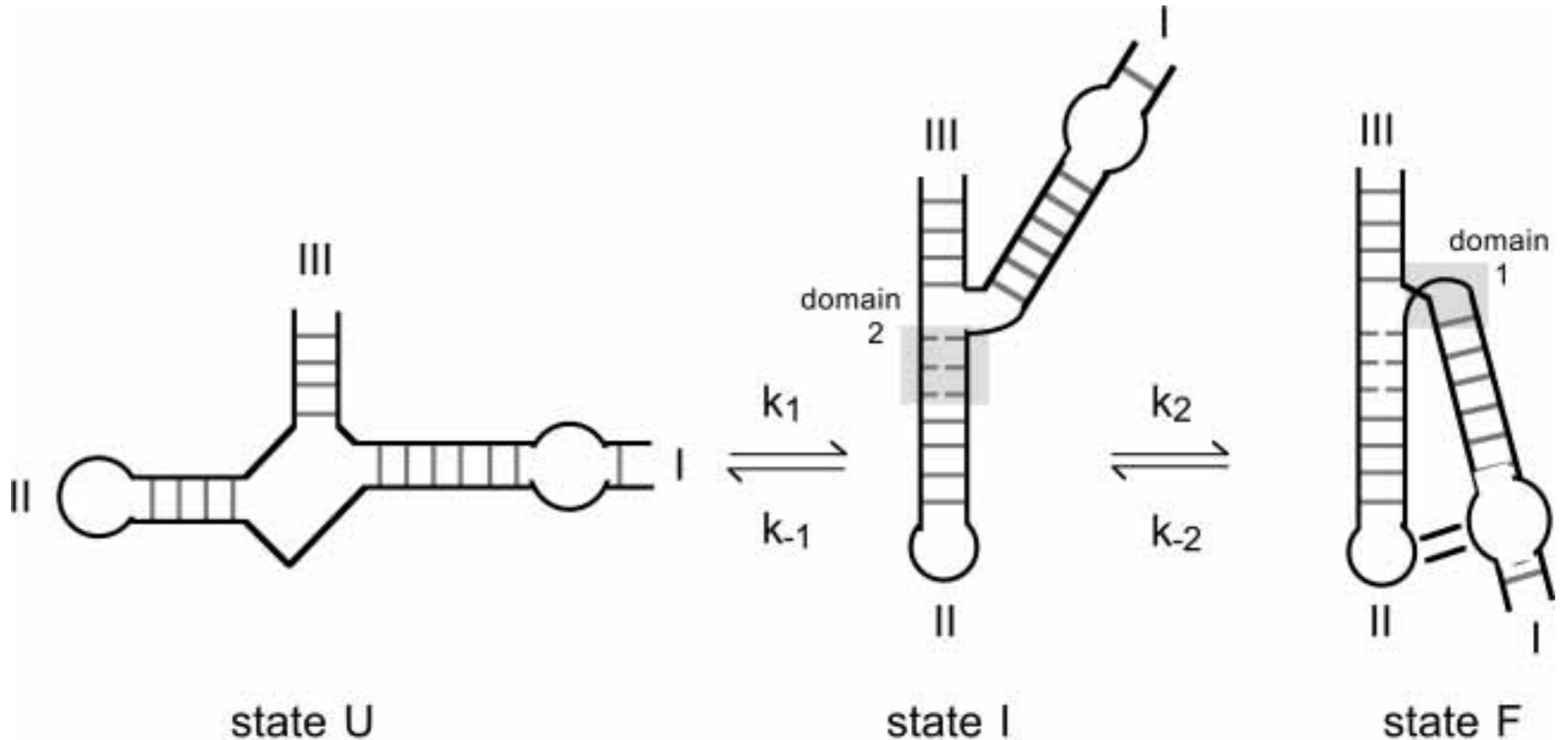

$$R_g(I)/(F) \sim 1.1$$

$$\text{ASBVd: } R_g(I)/(F) \sim 1.2$$

Penedo *et al.*, RNA, 2004.

# HHR morphing

Highly active form

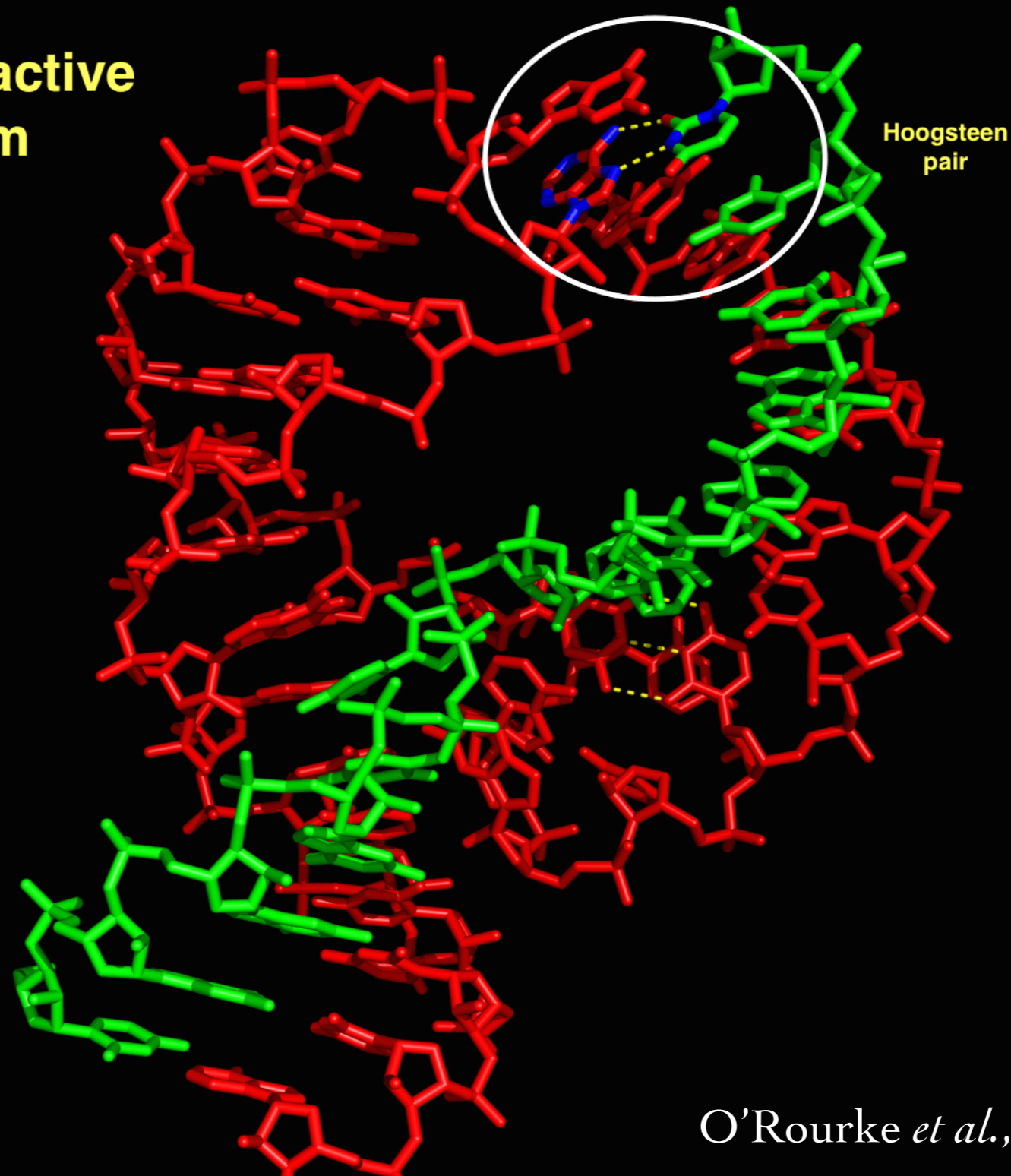

O'Rourke *et al.*, JMB, 2015

$R_g(I)/(F) \sim 1.1$

43

ASBVd:  $R_g(I)/(F) \sim 1.2$

# Modeling/SANS

$$R_g^{\text{exp}} = 31 \text{ \AA}$$
$$R_g^{*\text{calc}} = 31 (26) \text{ \AA}$$



$$d^{\text{exp}} = 96.0 \text{ \AA}$$
$$d^{\text{calc}} = 96.7 \text{ \AA}$$

# HHR (-): dimerization

**A**

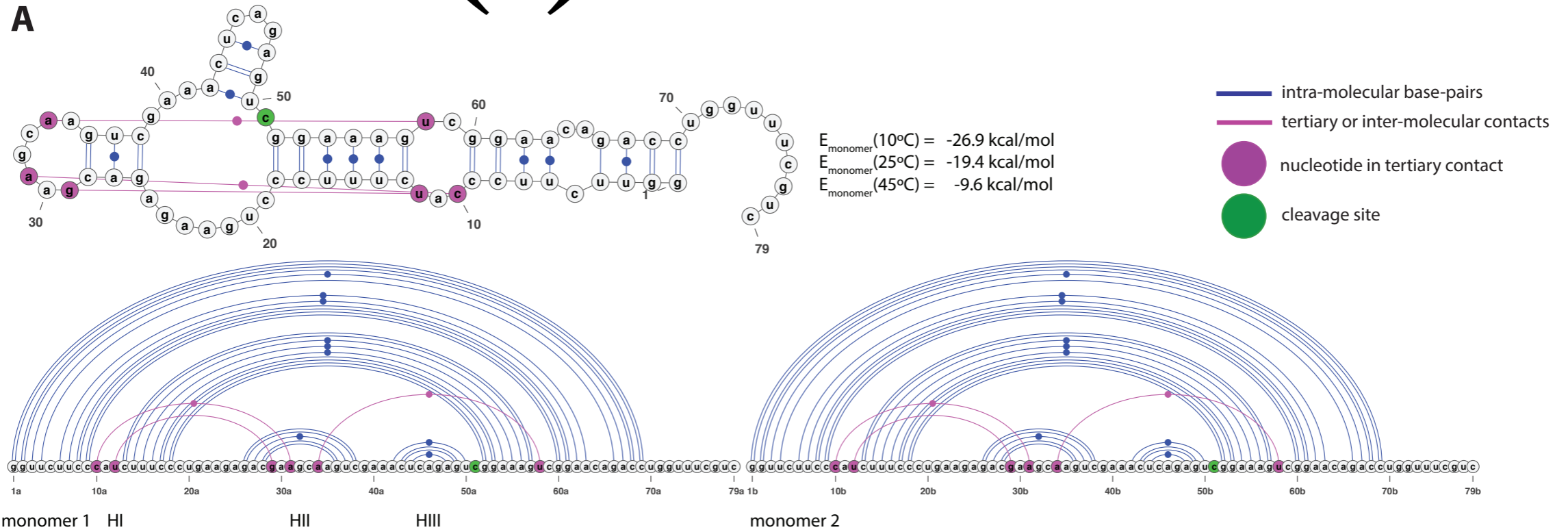

**B**

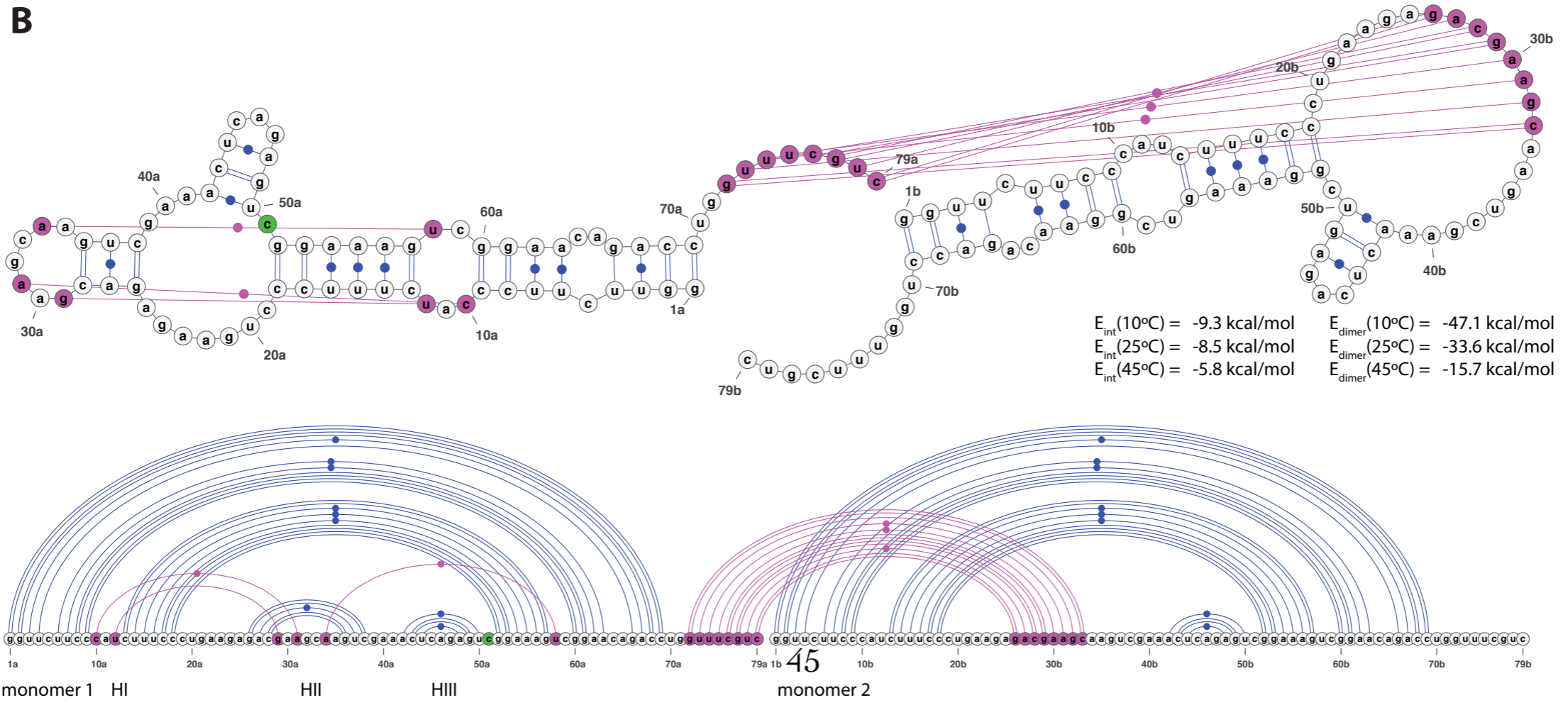

# HHR (-): dimerization

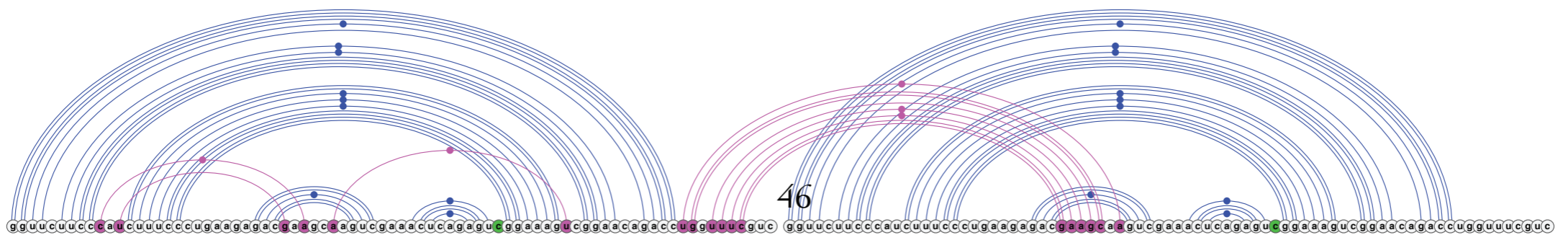
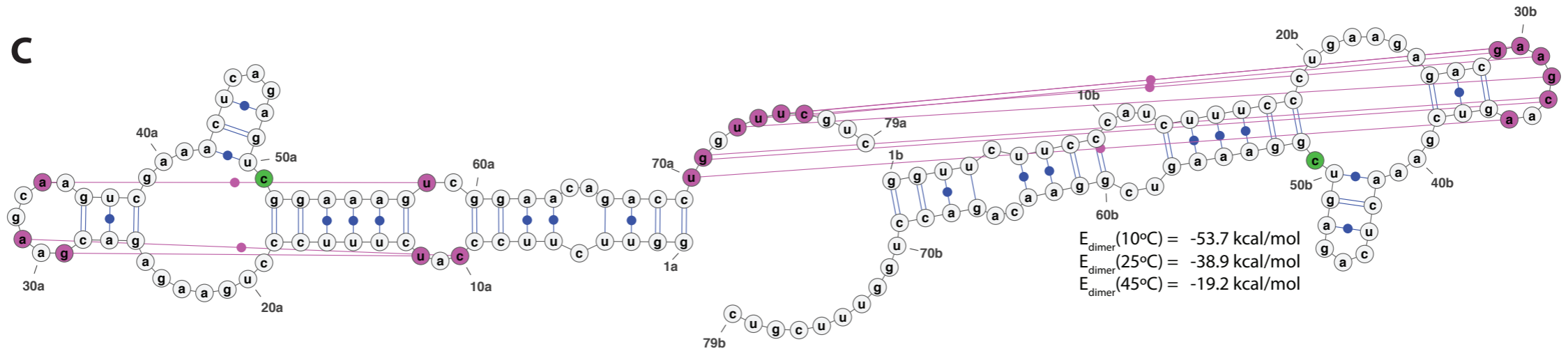
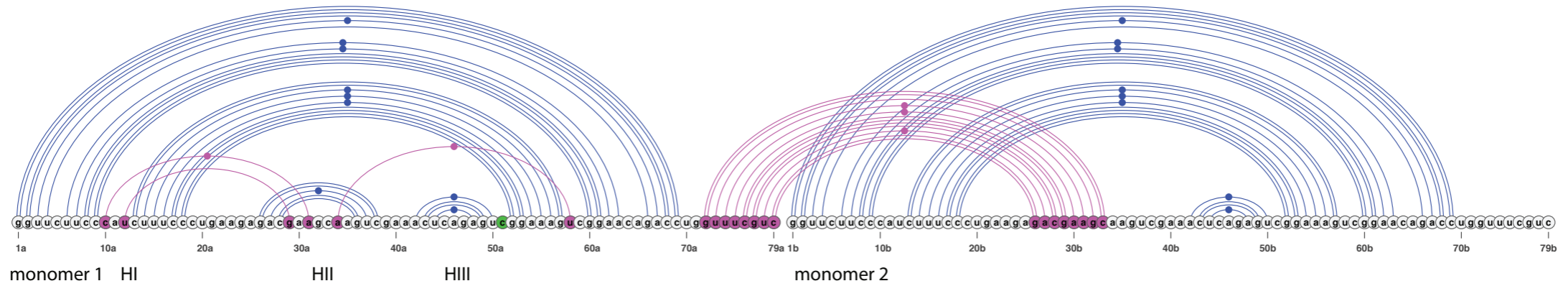
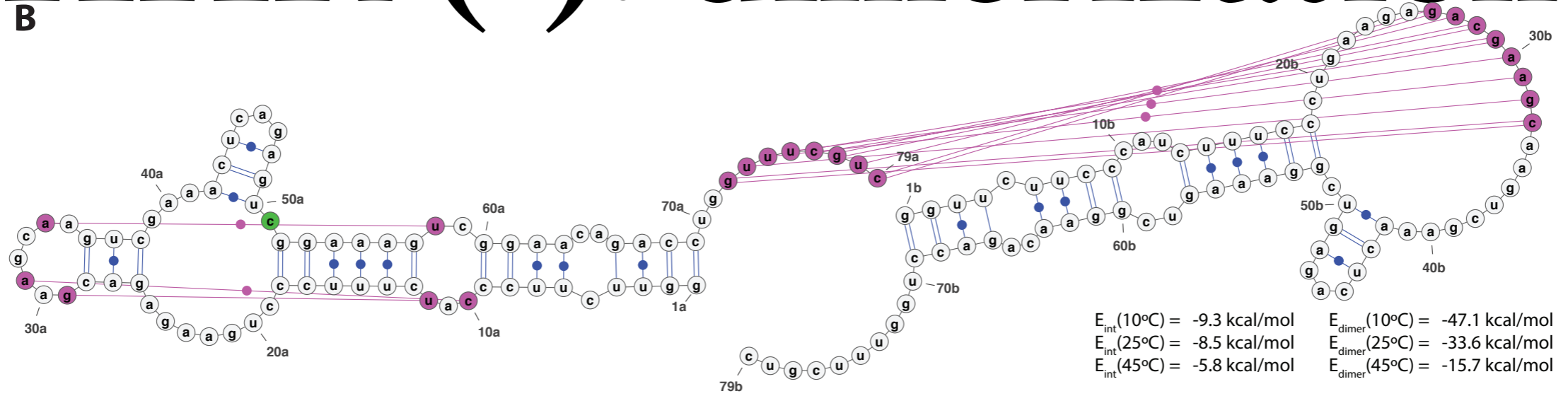

# HHR(-) dimer

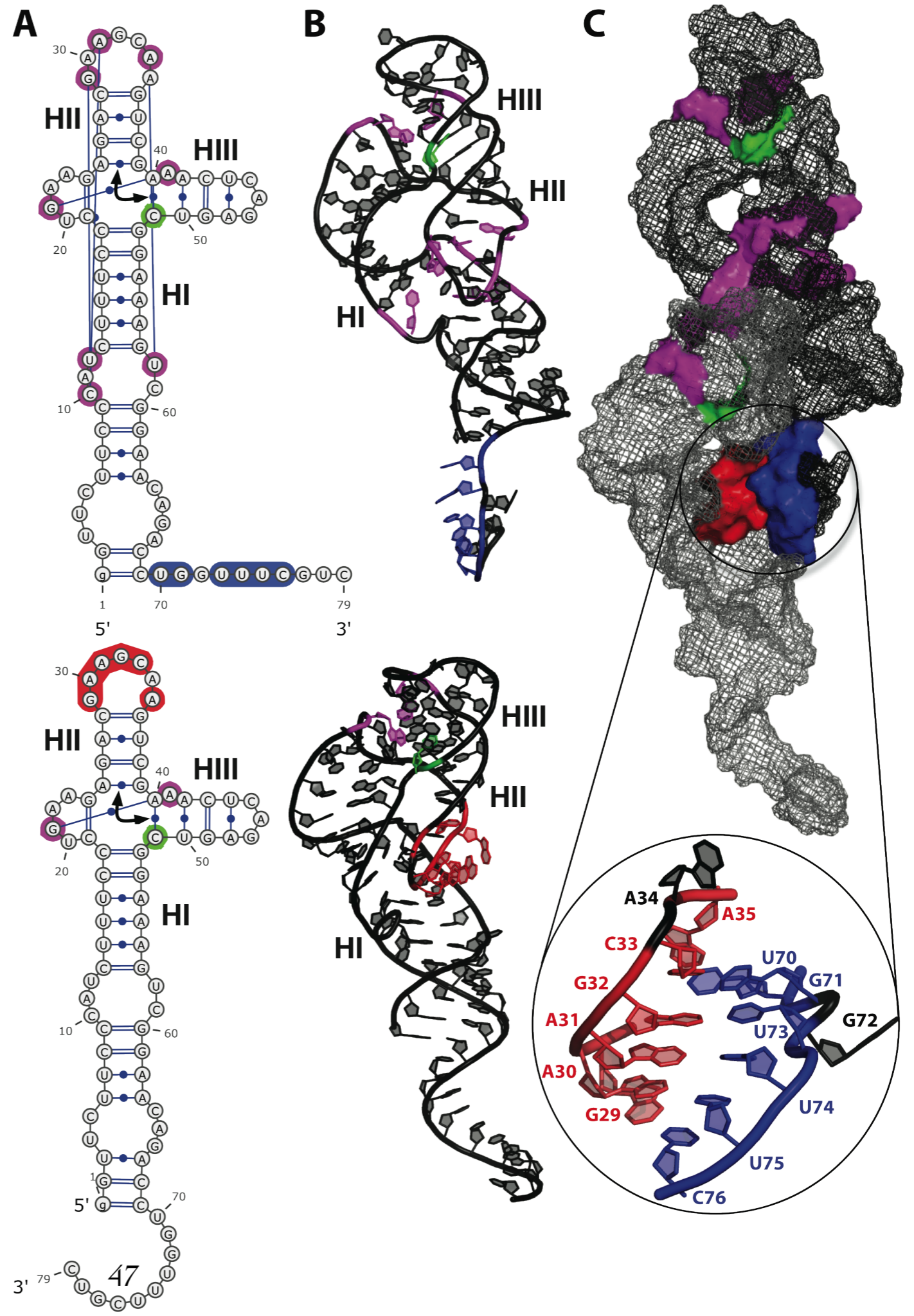
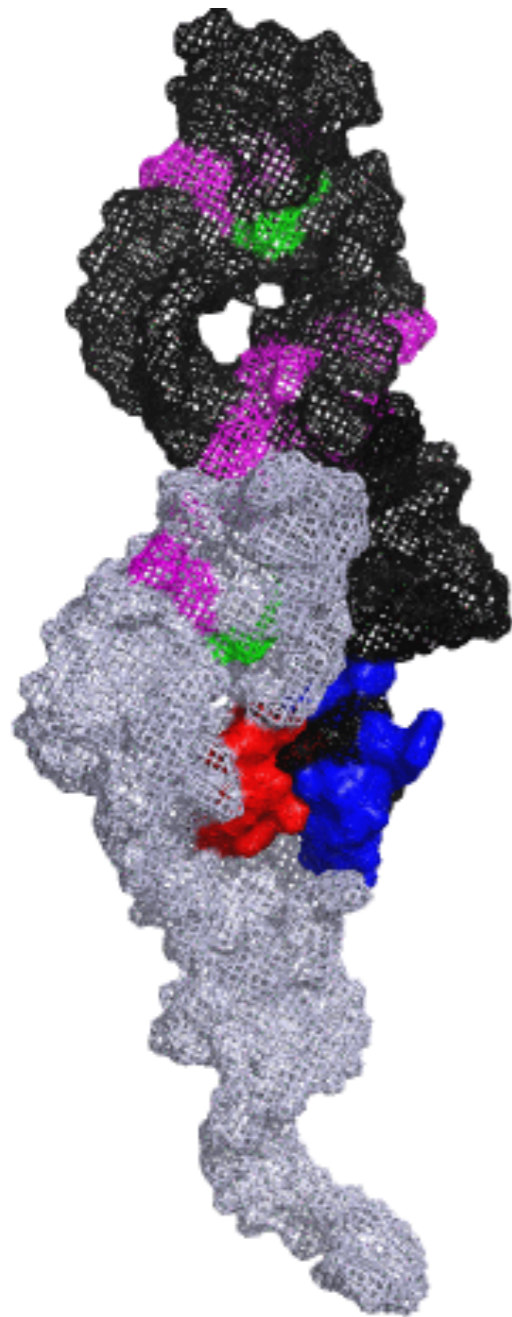

# HHR(-): monomer 1

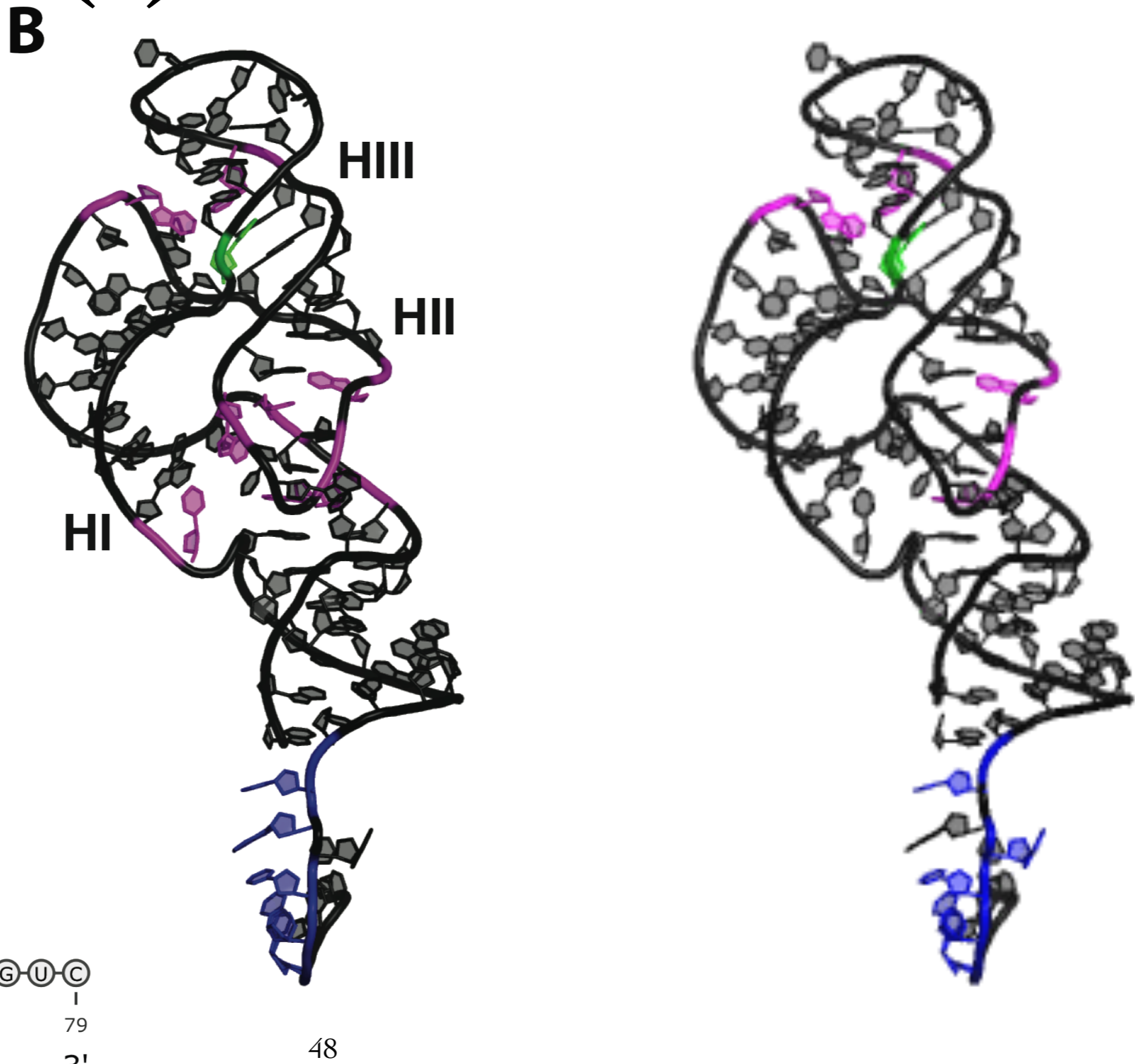
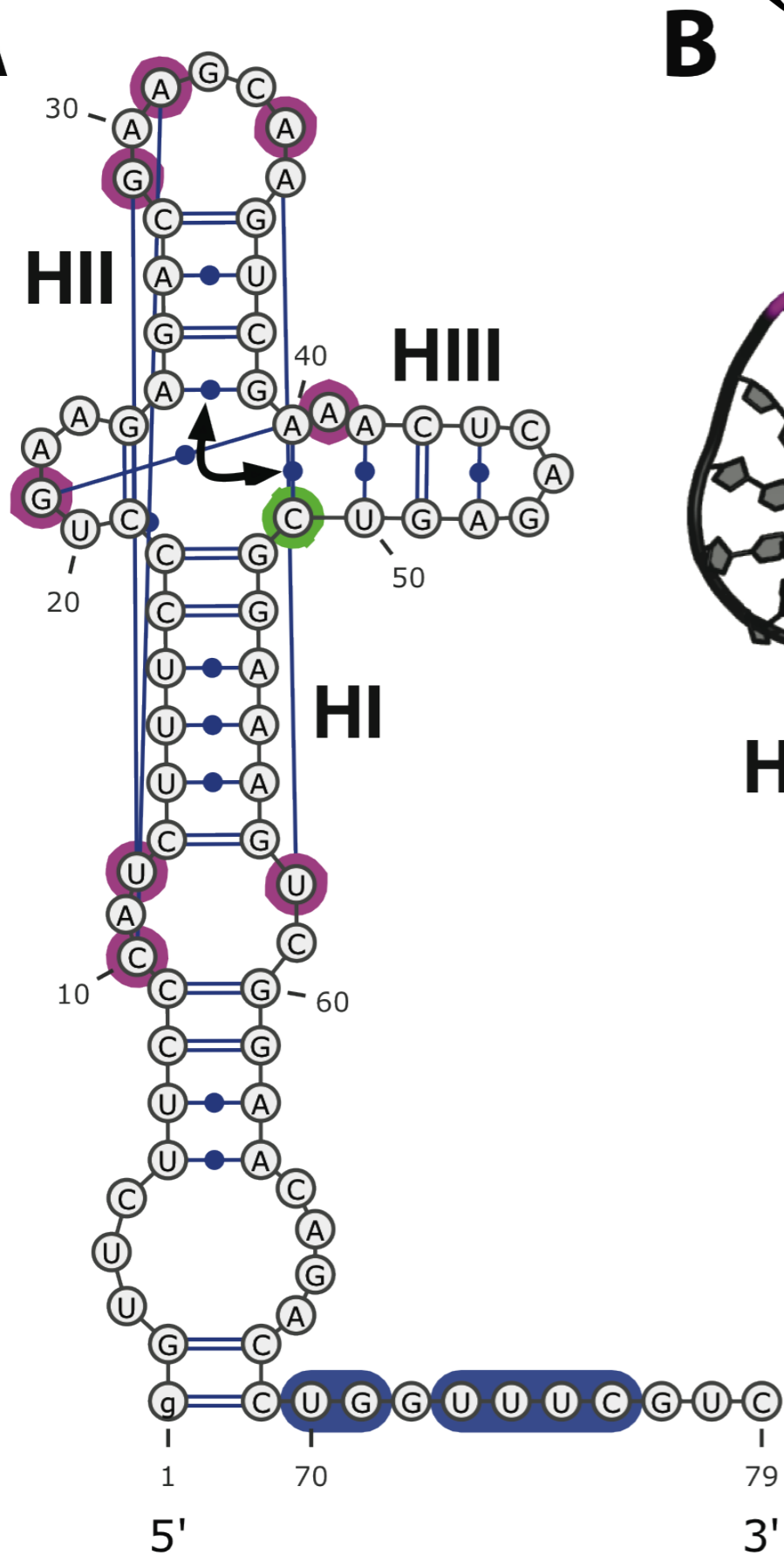

# HHR(-): monomer 2

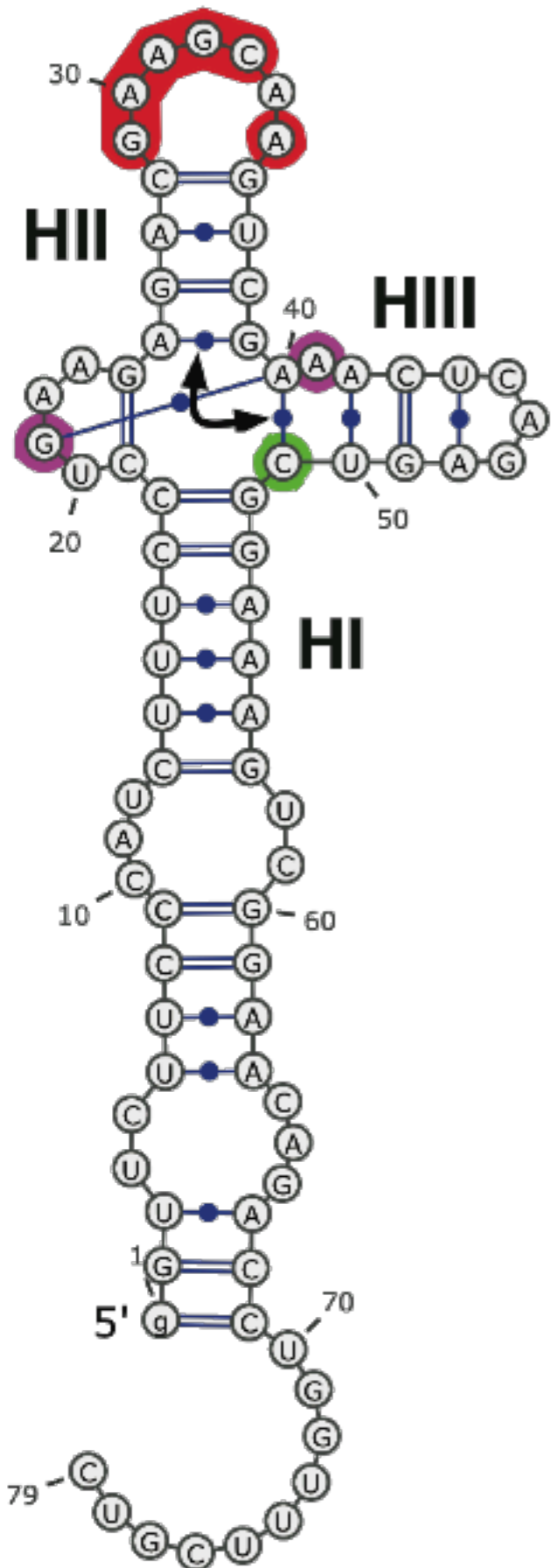

# HHR(-): monomer seeds

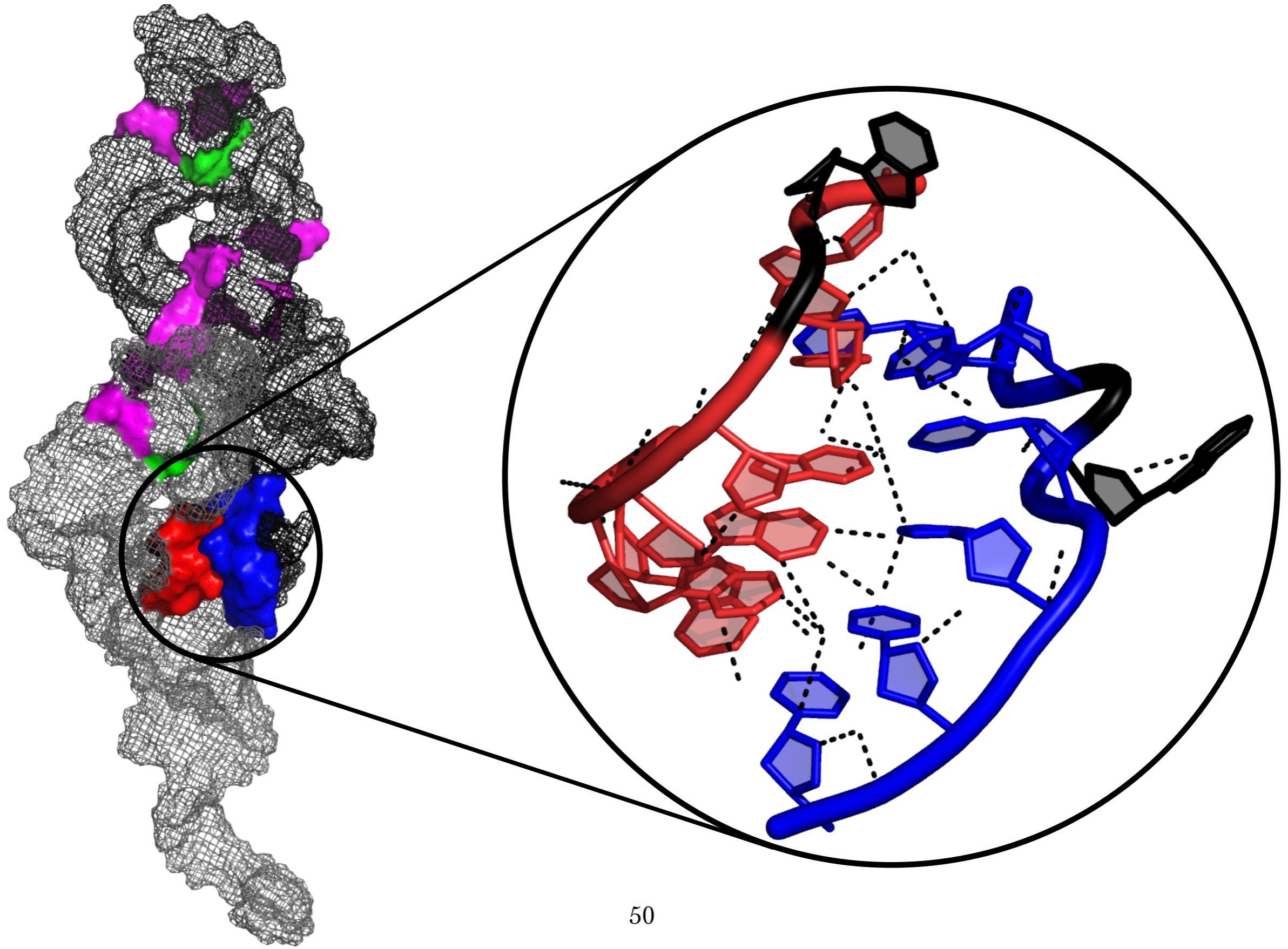

# HHR(-) monomers

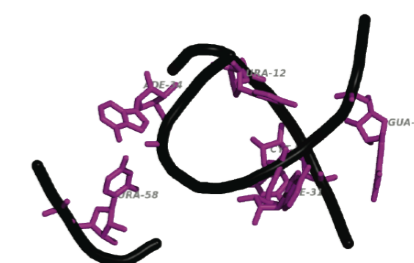
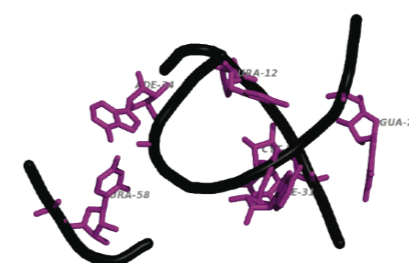
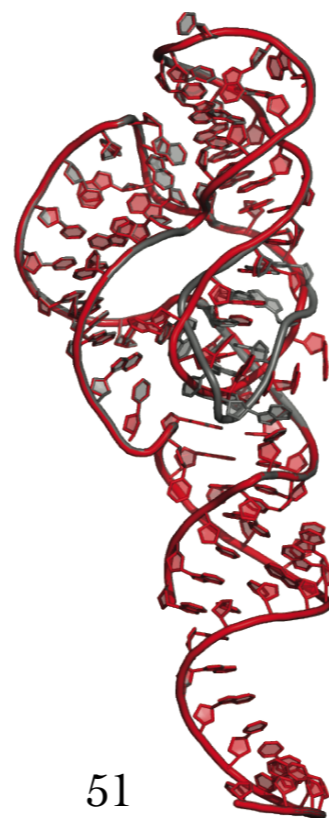
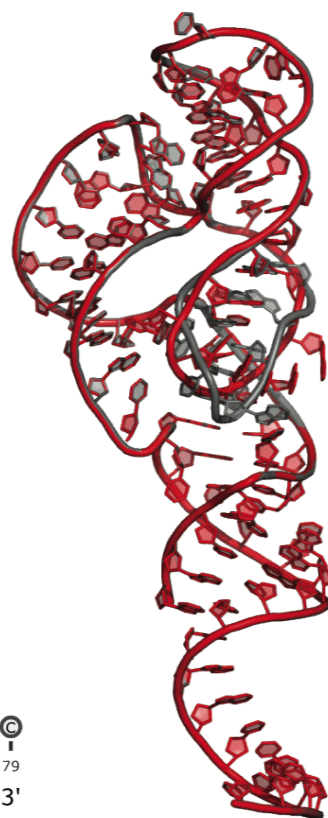
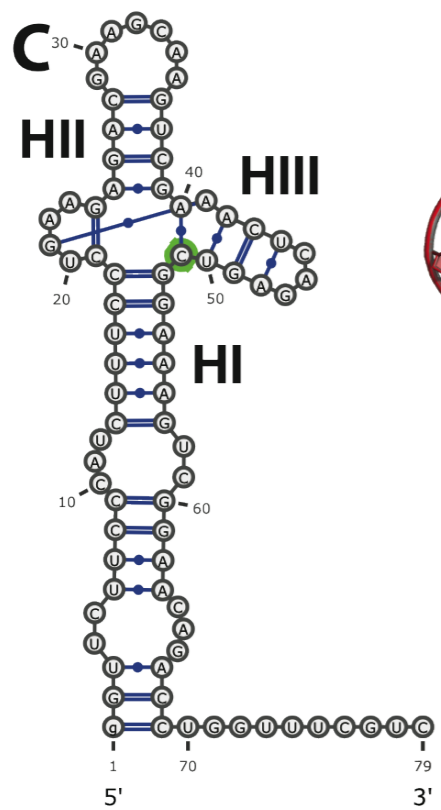
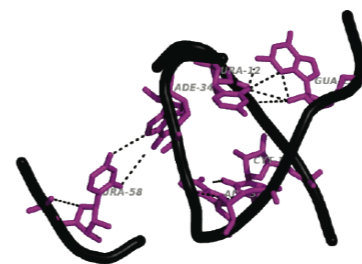
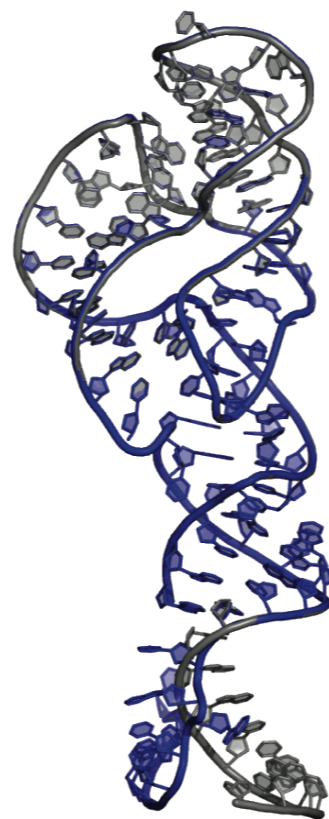
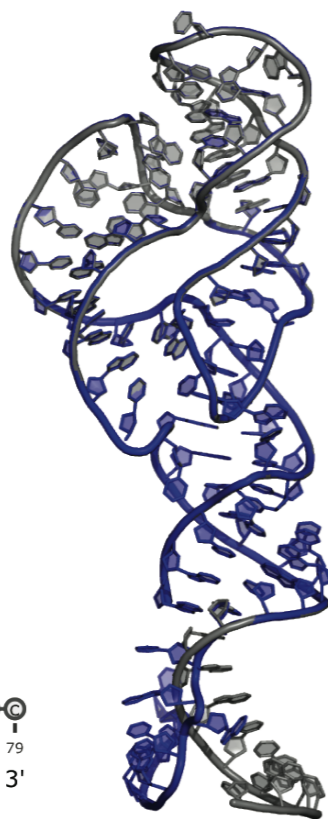
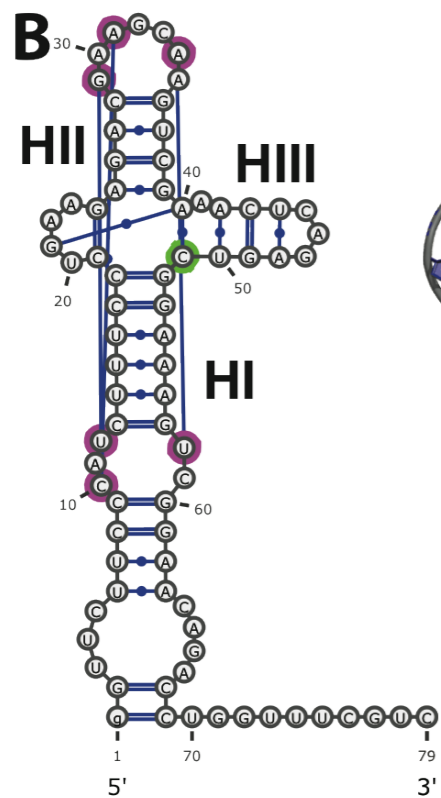

# HHR: Monomer & Dimer

A

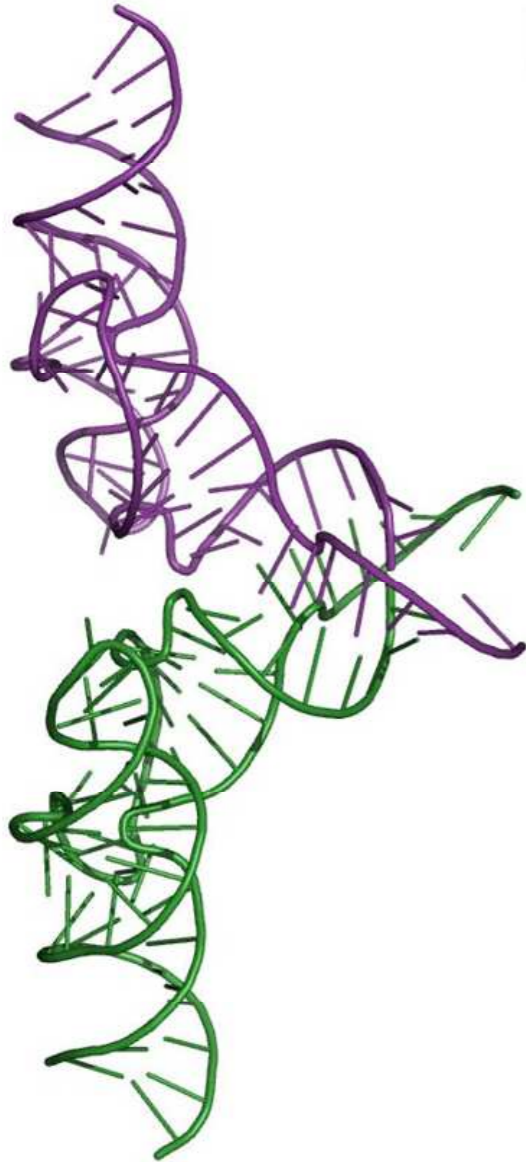

B



C



PDB ID:

# R<sub>g</sub> & self-association

HI/HII

HI/HI

core

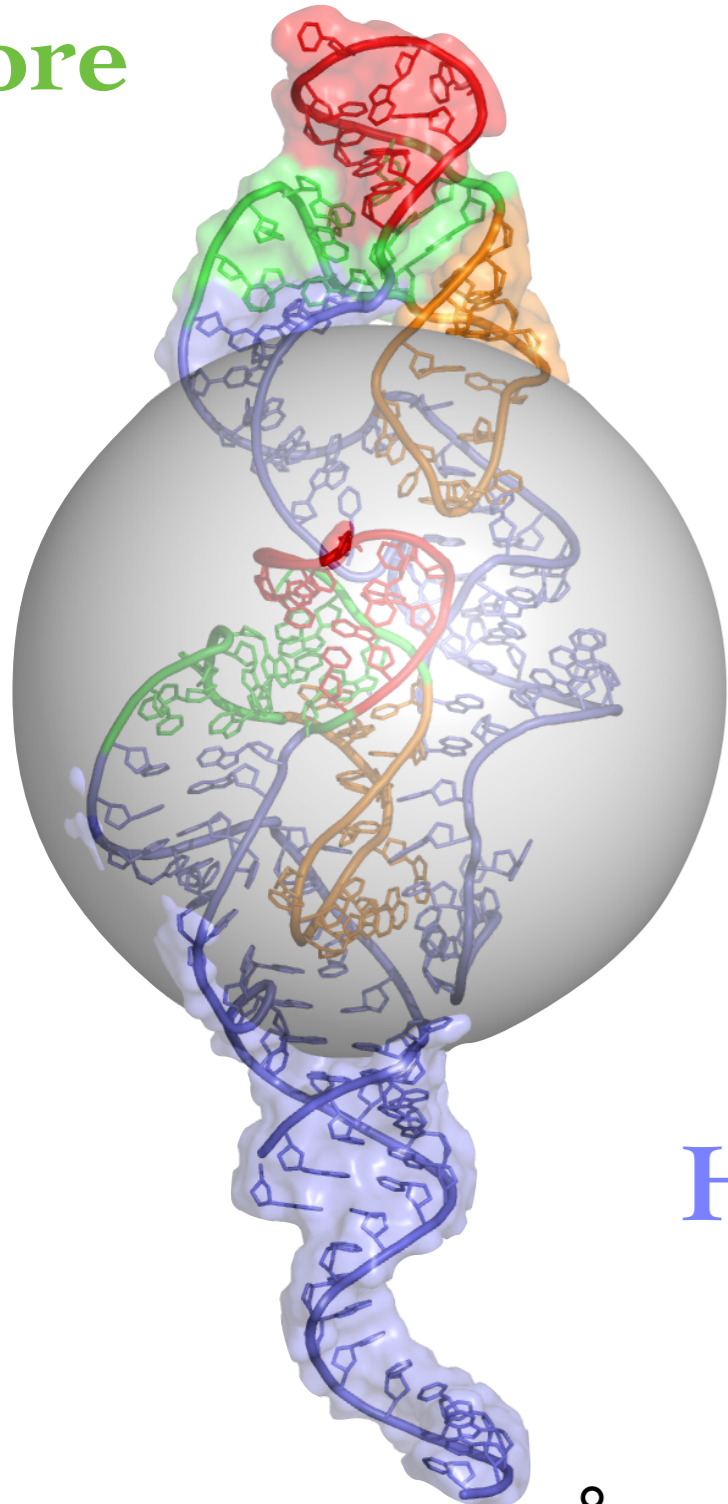

$R_g^* = 50.4 \text{ \AA}$

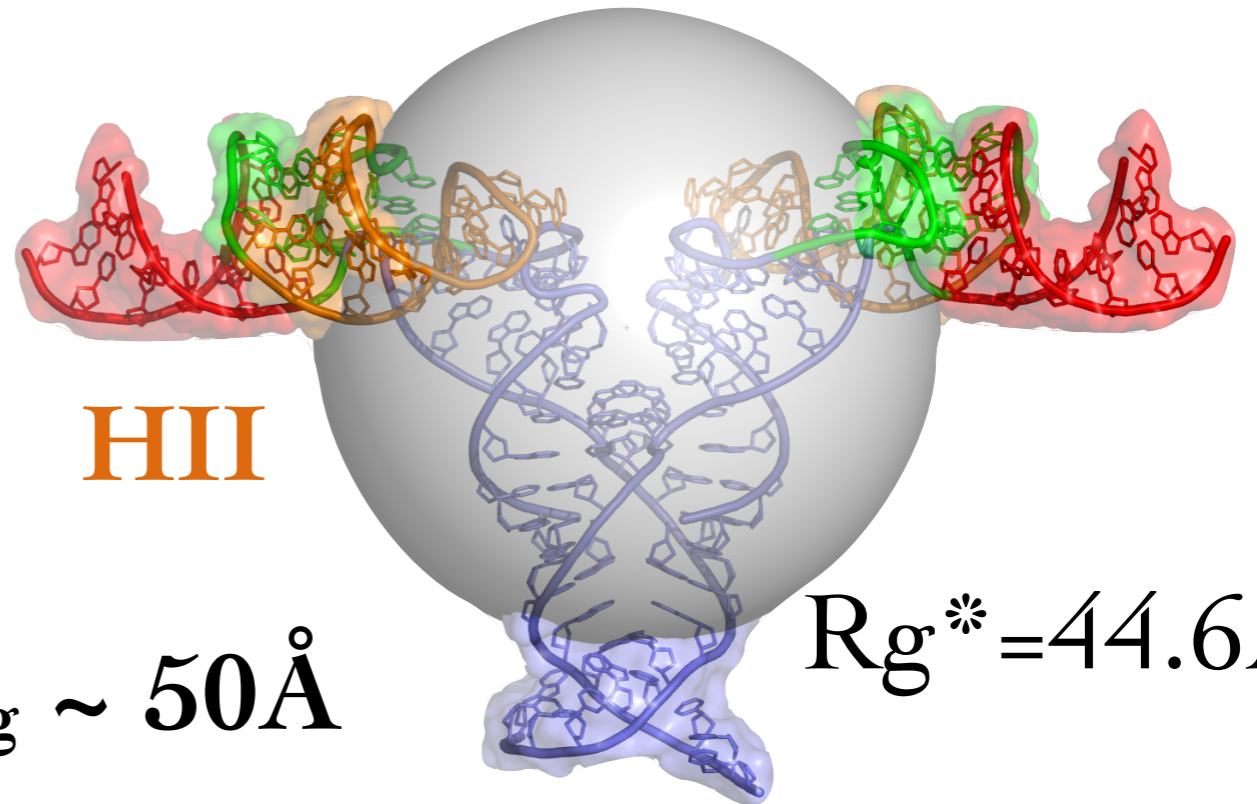

$R_g^* = 44.6 \text{ \AA}$

$R(\text{exp})_g \sim 50 \text{ \AA}$

HIII

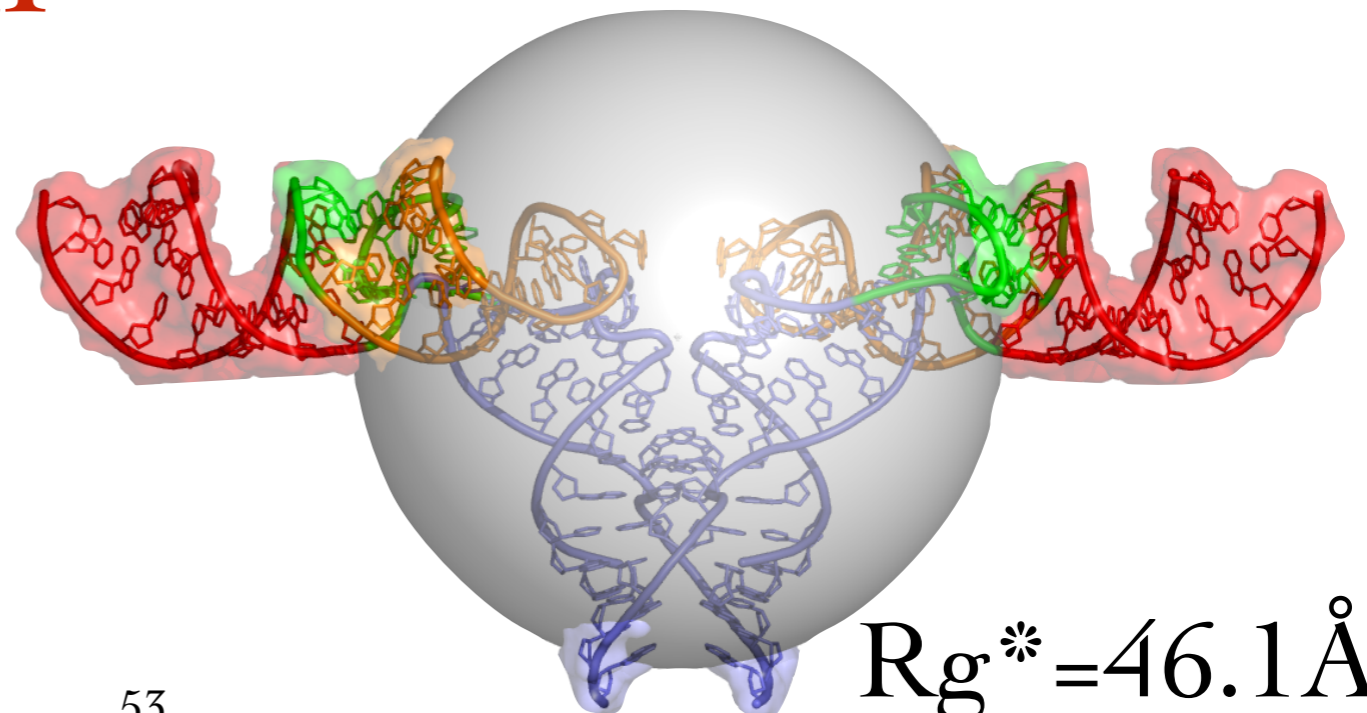

$R_g^* = 46.1 \text{ \AA}$

# MD setup for HHR dimer

- $\sim 300\,000$  atoms
- $K^+$  &  $Cl^-$  (0.15M)
- $T = (283K, 313K)$
- NAMMD

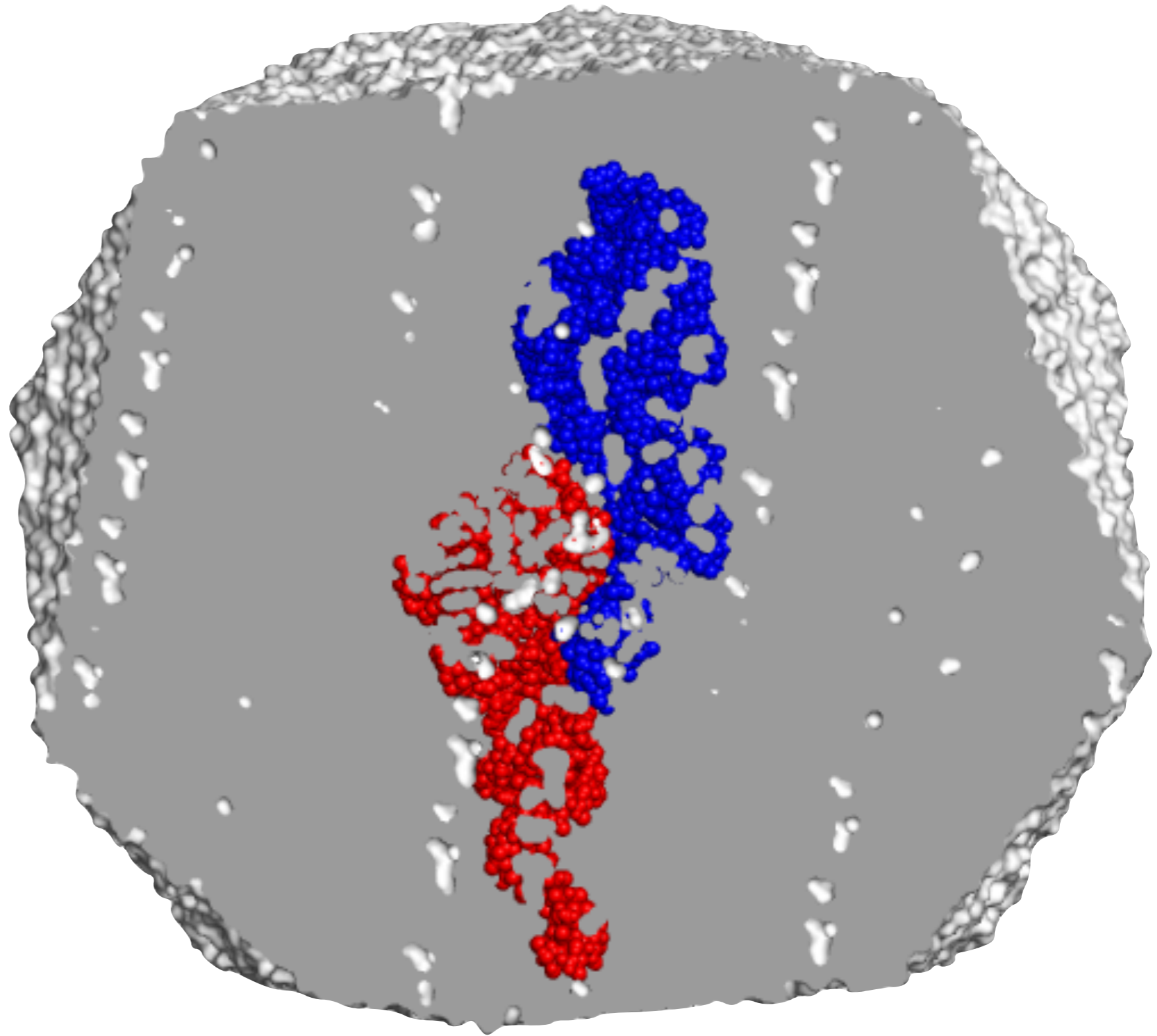

# Dynamics of HHR(-) dimer

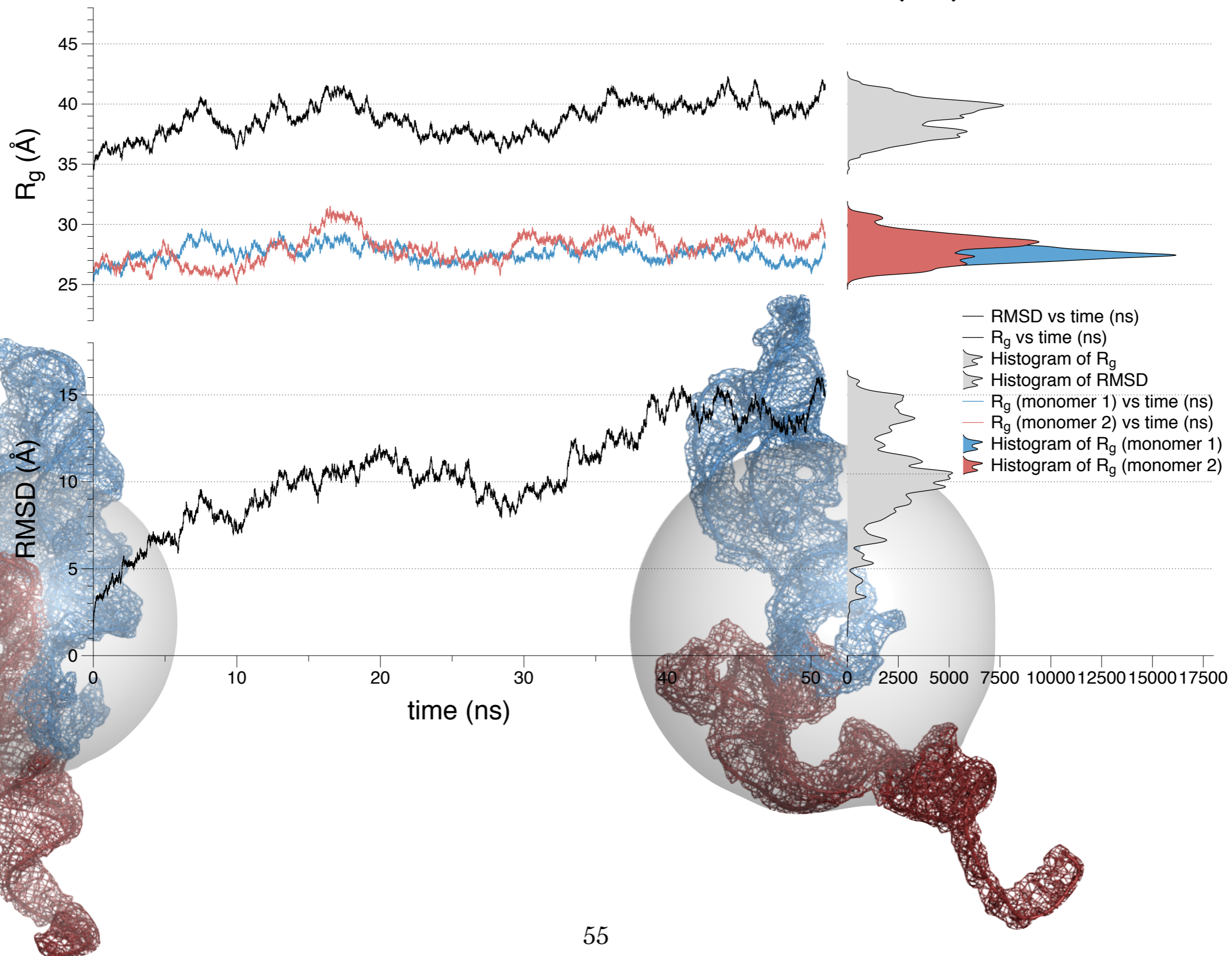

# HHH dimer: MD trajectory

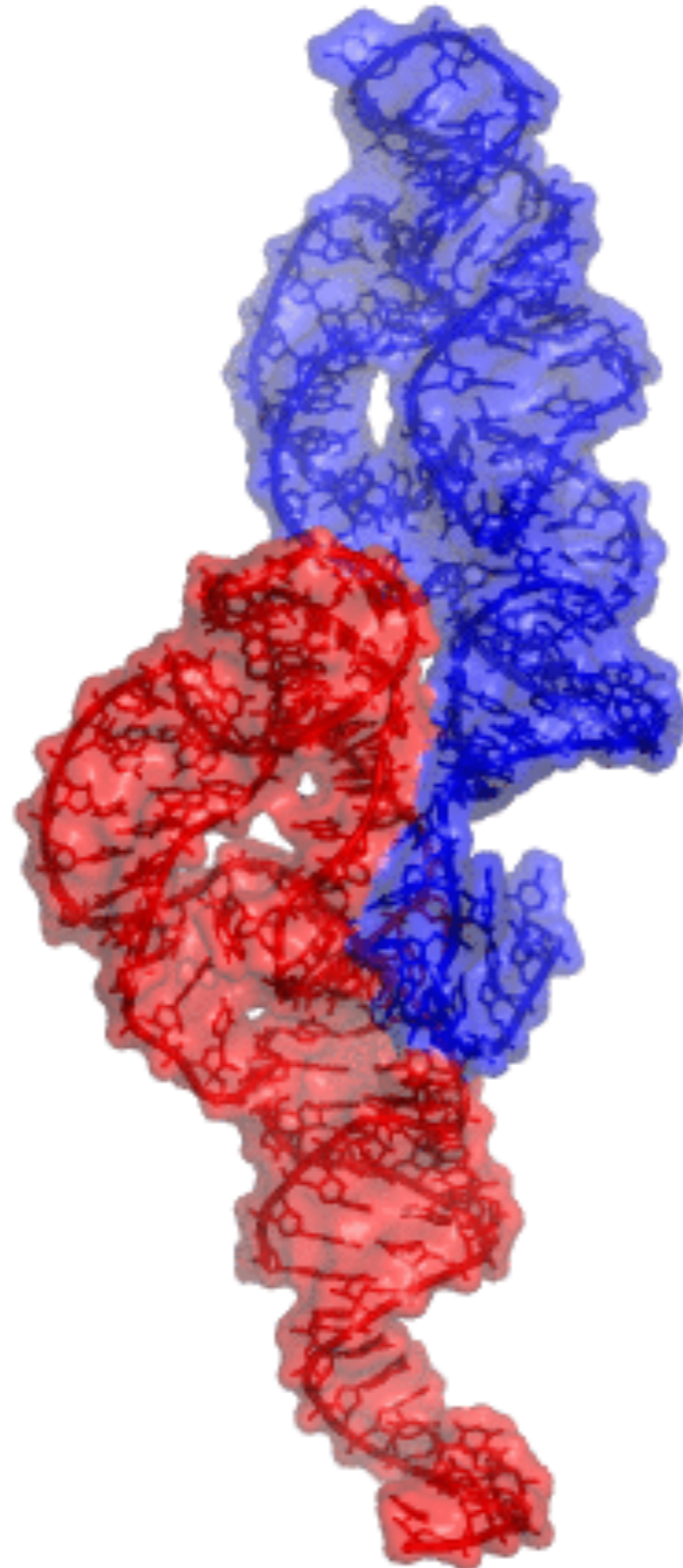

# ASBVd(-): self-association

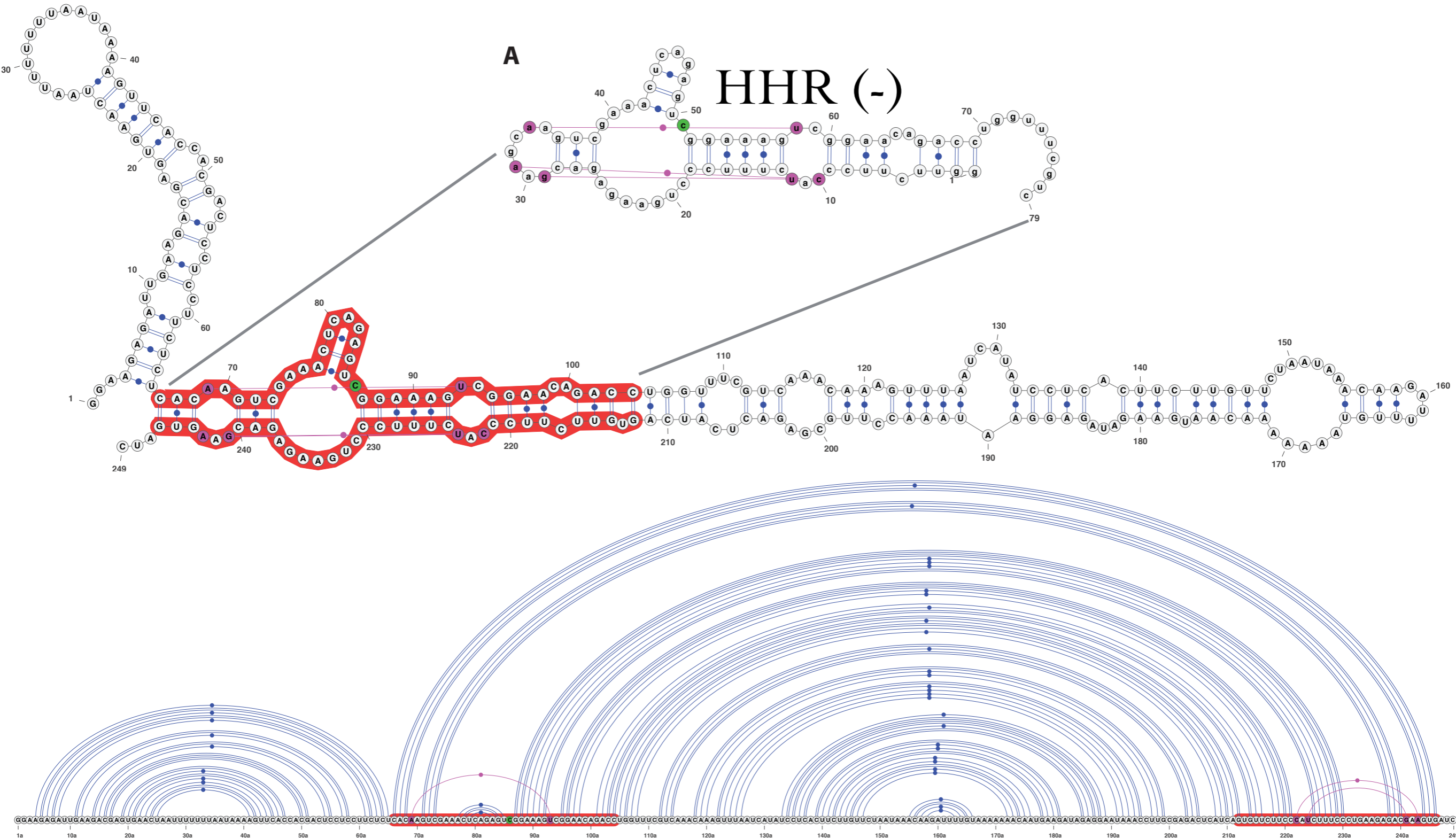

# ASBVd(-): self-association

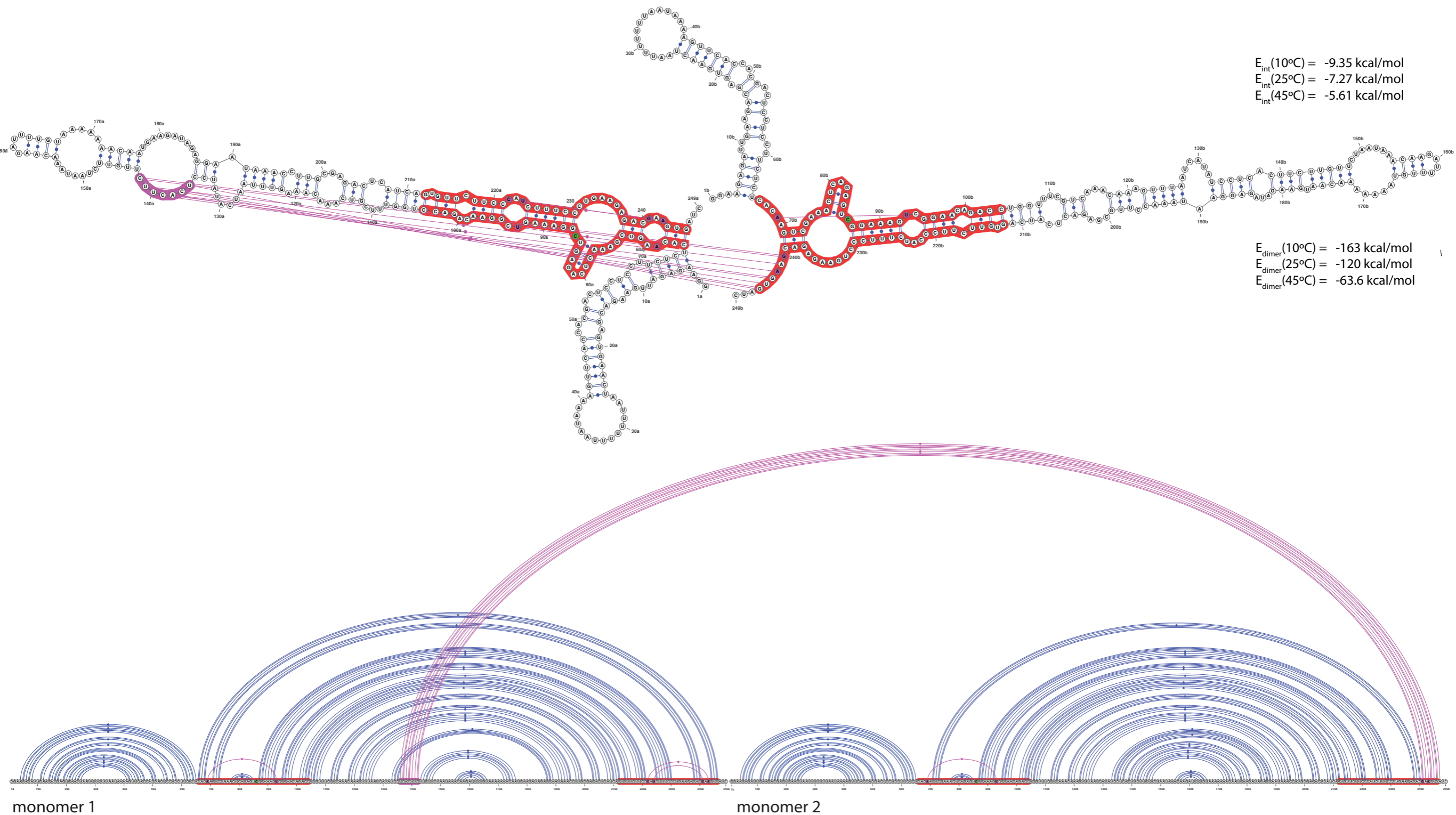

$E_{int}(10^{\circ}\text{C}) = -9.35 \text{ kcal/mol}$   
 $E_{int}(25^{\circ}\text{C}) = -7.27 \text{ kcal/mol}$   
 $E_{int}(45^{\circ}\text{C}) = -5.61 \text{ kcal/mol}$

$E_{dimer}(10^{\circ}\text{C}) = -163 \text{ kcal/mol}$   
 $E_{dimer}(25^{\circ}\text{C}) = -120 \text{ kcal/mol}$   
 $E_{dimer}(45^{\circ}\text{C}) = -63.6 \text{ kcal/mol}$

monomer 1

monomer 2

# ASBVd(-): self-association

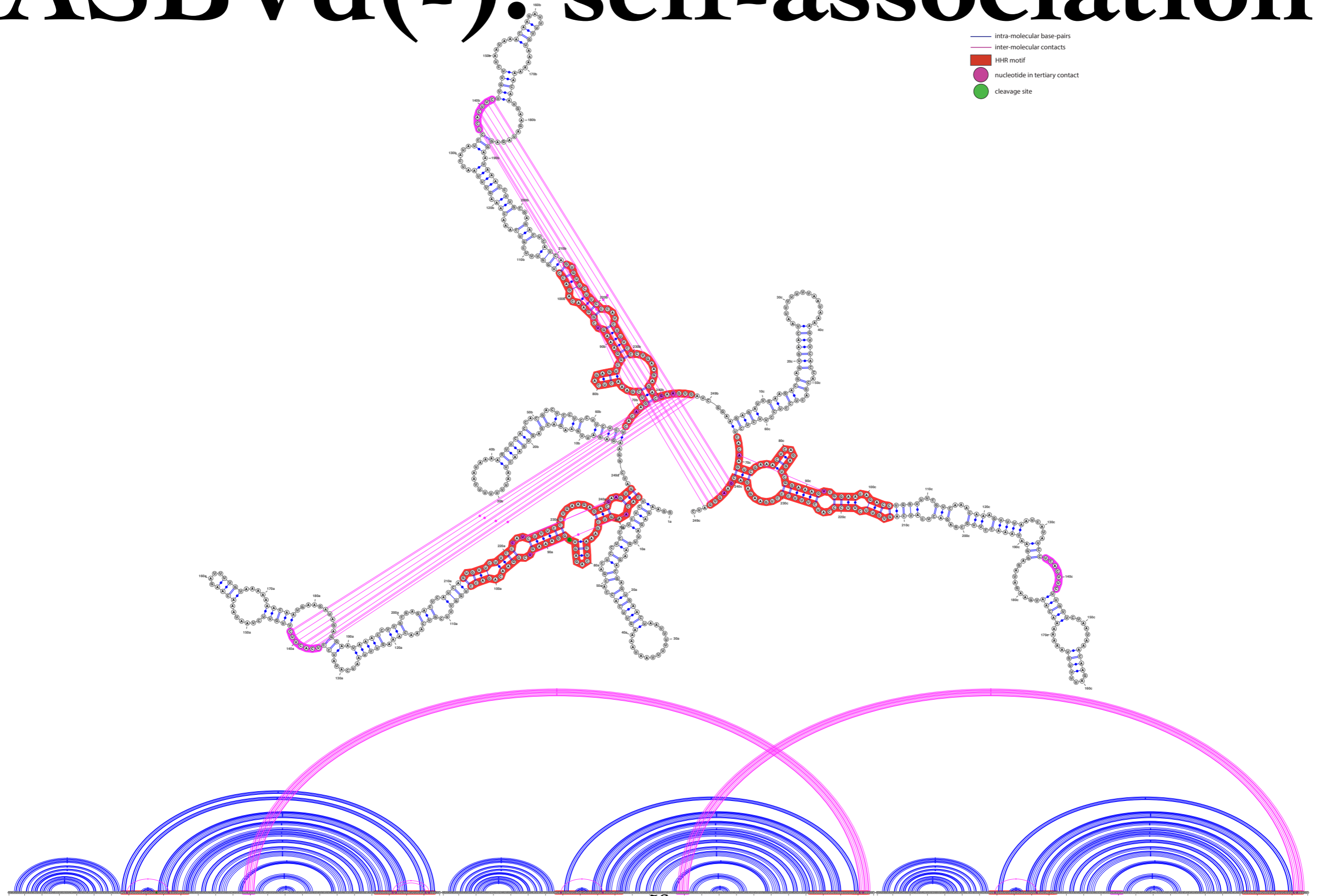

# What did we learn ?

- for RNA and ribozymes: « too short » may be bad
- don't forget about dynamics
- SANS & modeling approaches to infer self-association modes
- theoretical approaches to explore reaction mechanisms and pathways

# Viroids: Plant Parasites

Genus *Pospiviroids*:  
PSTVd (potato spindle tuber)



Genus *Hostuviroids*:  
HSVd (hop stunt)



Genus *Cocadviroids*:  
CCCVd (coconut cadang-cadang)



Genus *Apscaviroids*:  
ASSVd (apple scar skin)



Genus *Coleviroids*:  
CbVd 1 (coleus blumei 1)



Genus *Avsunviroids*:  
ASBVd (avocado sunblotch)



Genus *Pelamoviroids*:  
PLMVd (peach latent mosaic)



# Viroid & HDV: Hepatitis D

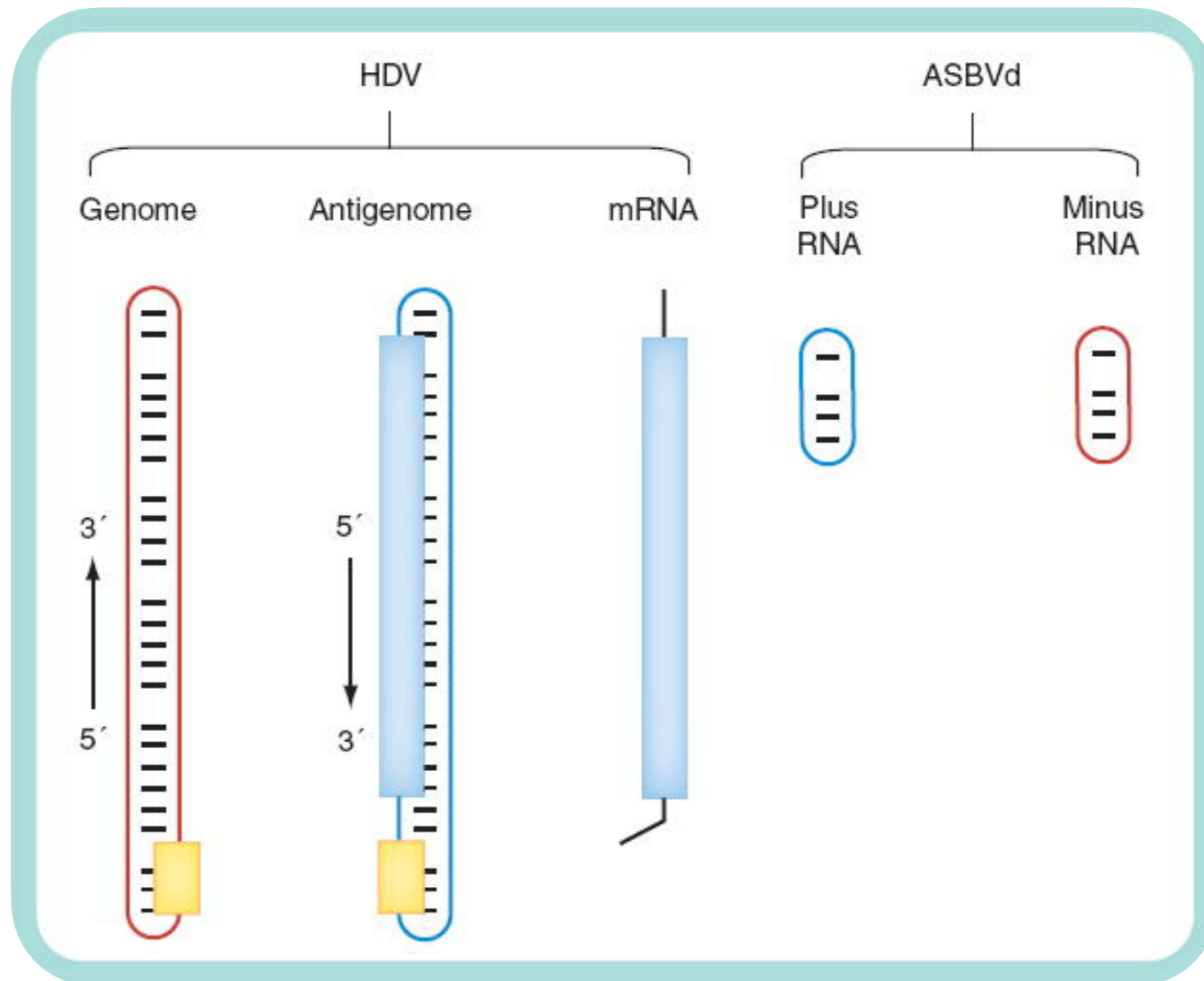

# Acknowledgments

- Zdenek Chval (University of South Bohemia, CK)
- Daniela Chvalová (University of South Bohemia, CK)
- Xavier Lopez (Euskal Herriko Unibertsitatea, SP)
- Annick Dejaegere (ESBS Strasbourg)
- Darrin M. York (Rutgers University, USA)
- Martin Karplus (Harvard University, USA)
- Giuseppe Zaccai (IBS, Grenoble)
- Jacques Vergne (MNHN, Paris)
- Anne Martel (ILL, Grenoble)
- Martina Rihova (Institute of Physics, Prague, CK)
- Marie-Christine Maurel (MNHN, Paris)
- William G. Scott (UCSC, Santa-Cruz, USA)

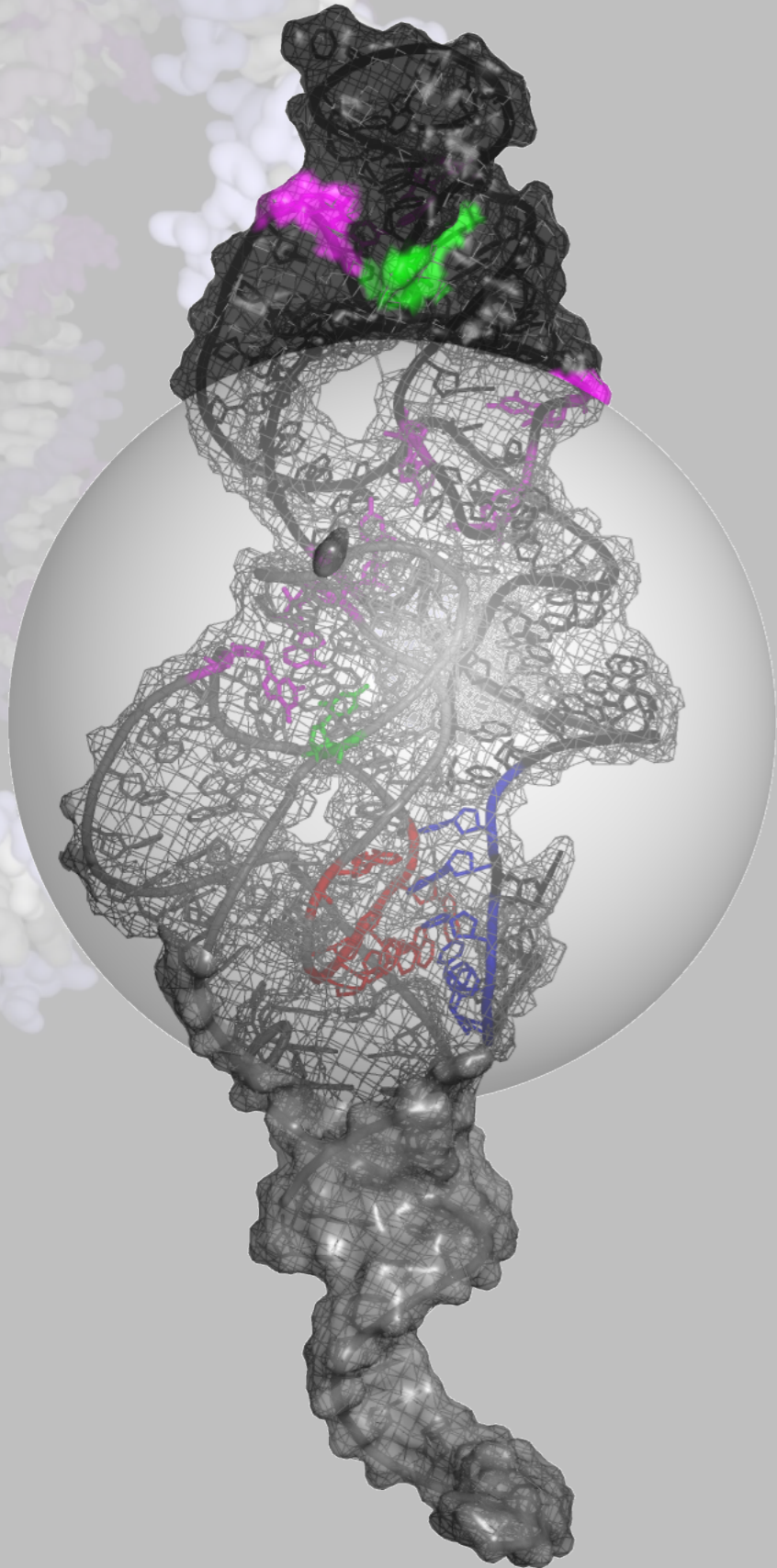

# Elements

An International Magazine of Mineralogy, Geochemistry, and Petrology

December 2016  
Volume 12, Number 6

ISSN 1811-5209

## Origins of Life: Transition from Geochemistry to Biogeochemistry

NITA SAHAI and HUSSEIN KADDOUR, Guest Editors

Transition from Geochemistry to Biogeochemistry

Staging Life: Early Ocean

Incubating Life: Prebiotic Sources

Foundation Stones to Life

Metal Catalysts

Protometabolism and Early Protocells

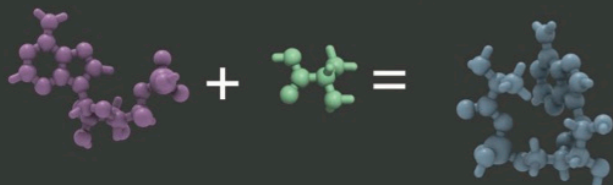

## Fabrice Leclerc, Ph.D.

I2BC / Dept. de Biologie des Génomés,  
« Séquence Structure Fonction des ARN »

SSFA (D. Gautheret)

[fabrice.leclerc@u-psud.fr](mailto:fabrice.leclerc@u-psud.fr)

# Assembling the RNA World

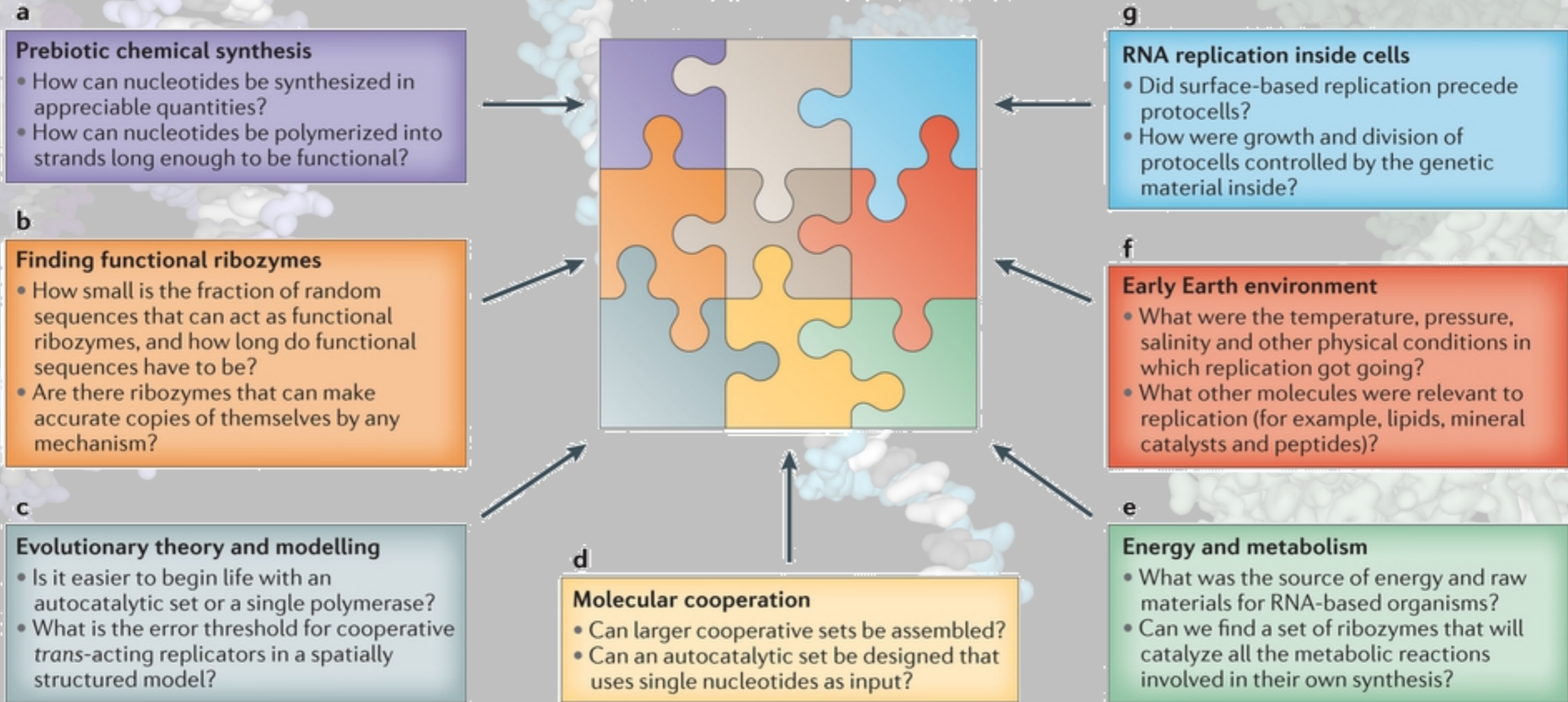

Higgs & Lehman, Nat. Rev. Genet., 2011

# Viroids: Phylogeny

## REPLICATION

## FAMILY

## SUBFAMILY

## GENUS

## SPECIES

## ASYMMETRIC PATHWAY

*Pospiviroidae*

*Pospiviroidae*

*Pospiviroids*

**Potato spindle tuber (PSTVd)**  
Mexican papita (MPVd)  
Tomato planta macho (TPMVd)  
Chrysanthemum stunt (CSVd)  
Citrus exocortis (CEVd)  
Tomato apical stunt (TASVd)  
Iresine 1 (IrVd 1)  
Columnnea latent (CLVd)

*Hostuviroids*

**Hop stunt (HSVd)**

*Cocadviroids*

**Coconut cadang-cadang (CCCVd)**  
Coconut tin angaja (CTIVd)  
Hop latent (HLVd)  
Citrus IV (CVd-IV)

*Apscaviroidae*

*Apscaviroids*

**Apple scar skin (ASSVd)**  
Citrus III (CVd-III)  
Apple dimple fruit (ADFVd)  
Grapevine yellow speckle 1 (GYSVd 1)  
Grapevine yellow speckle 2 (GYSVd 2)  
Citrus bent leaf (CBLVd)  
Pear blister canker (PBCVd)  
Australian grapevine (AGVd)

*Coleviroidae*

*Coleviroids*

**Coleus blumei 1 (CbVd 1)**  
Coleus blumei 2 (CbVd 2)  
Coleus blumei 3 (CbVd 3)

## SYMMETRIC PATHWAY

*Avsunviroidae*

*Avsunviroids*

**Avocado sunblotch (ASBVd)**

*Pelamoviroids*

**Peach latent mosaic (PLMVd)**  
Chrysanthemum chlorotic mottle (CChMVd)

# Modeling RNA-RNA Interactions

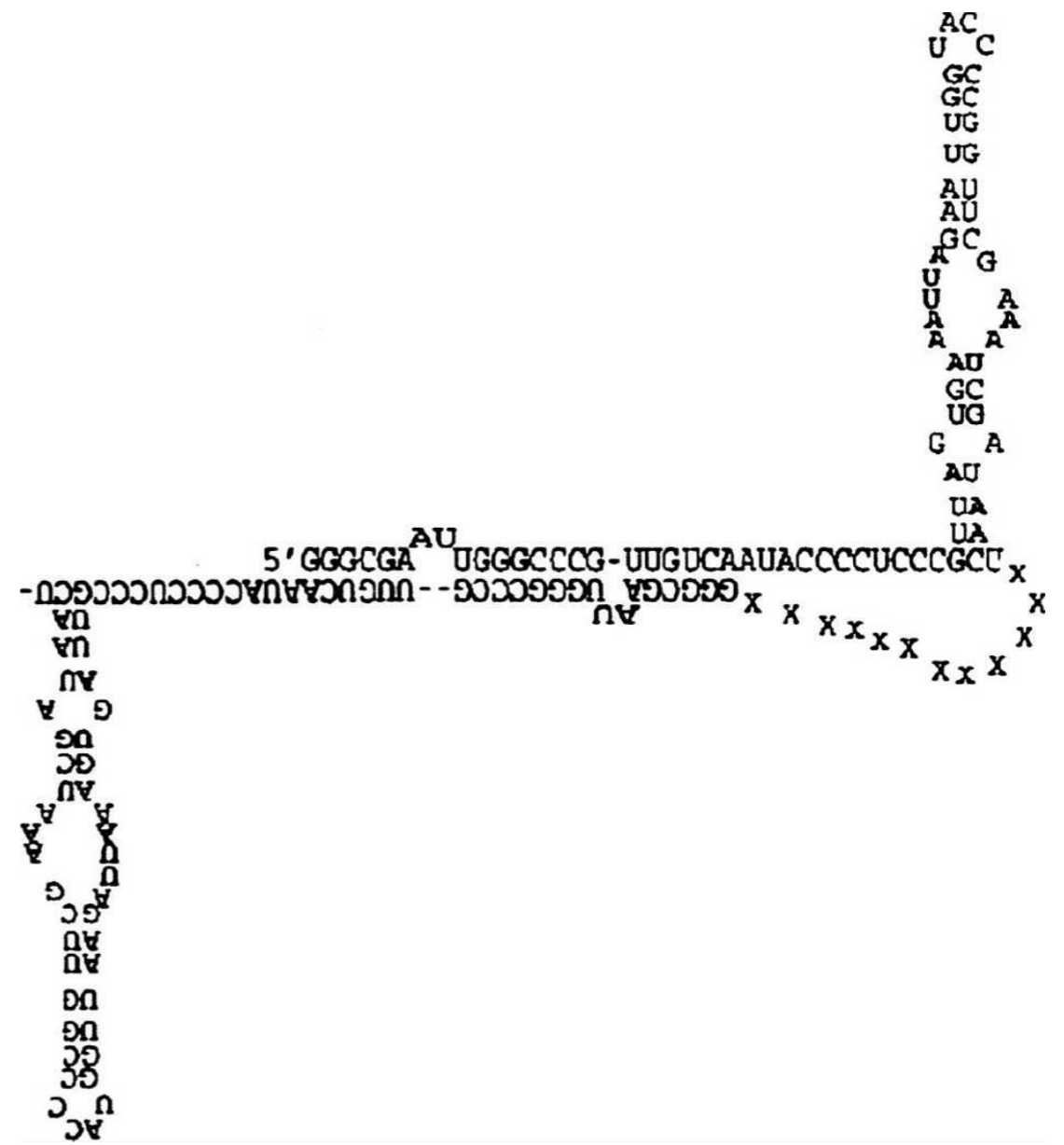
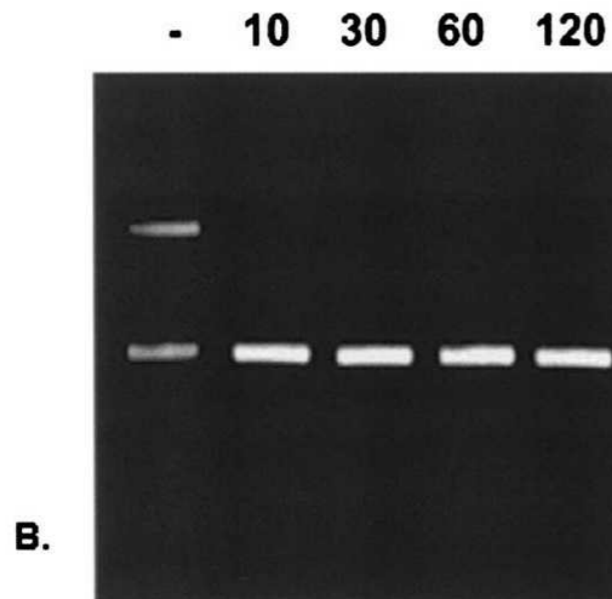
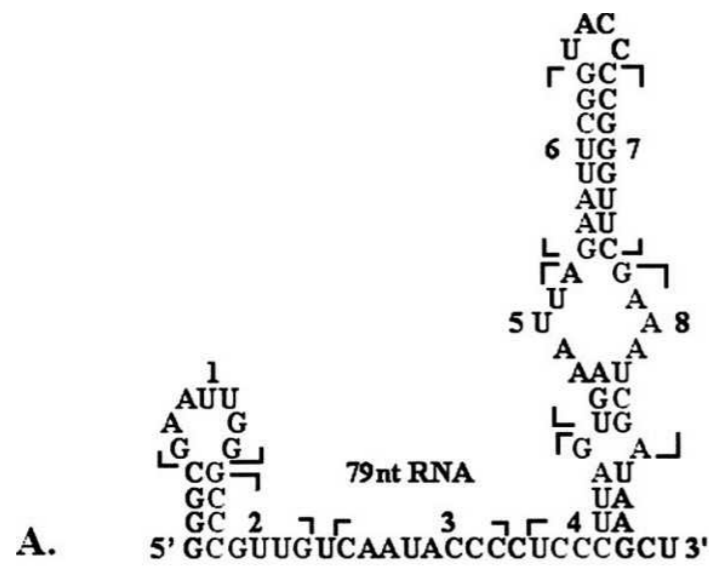

# HHH motifs

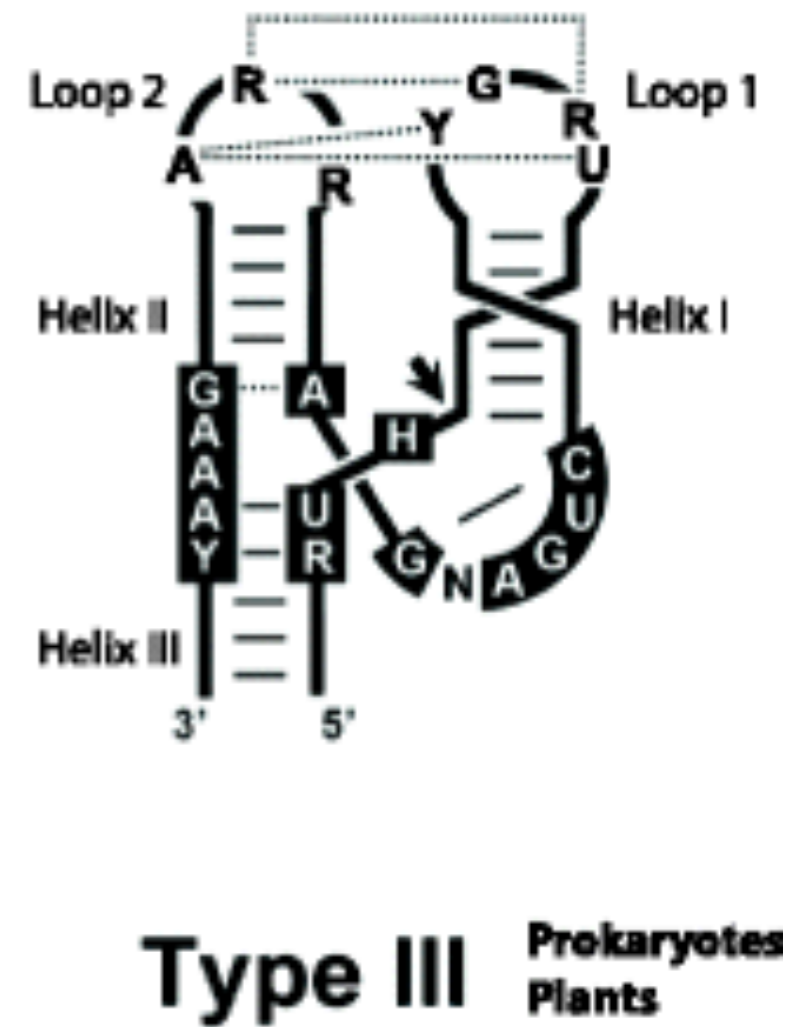
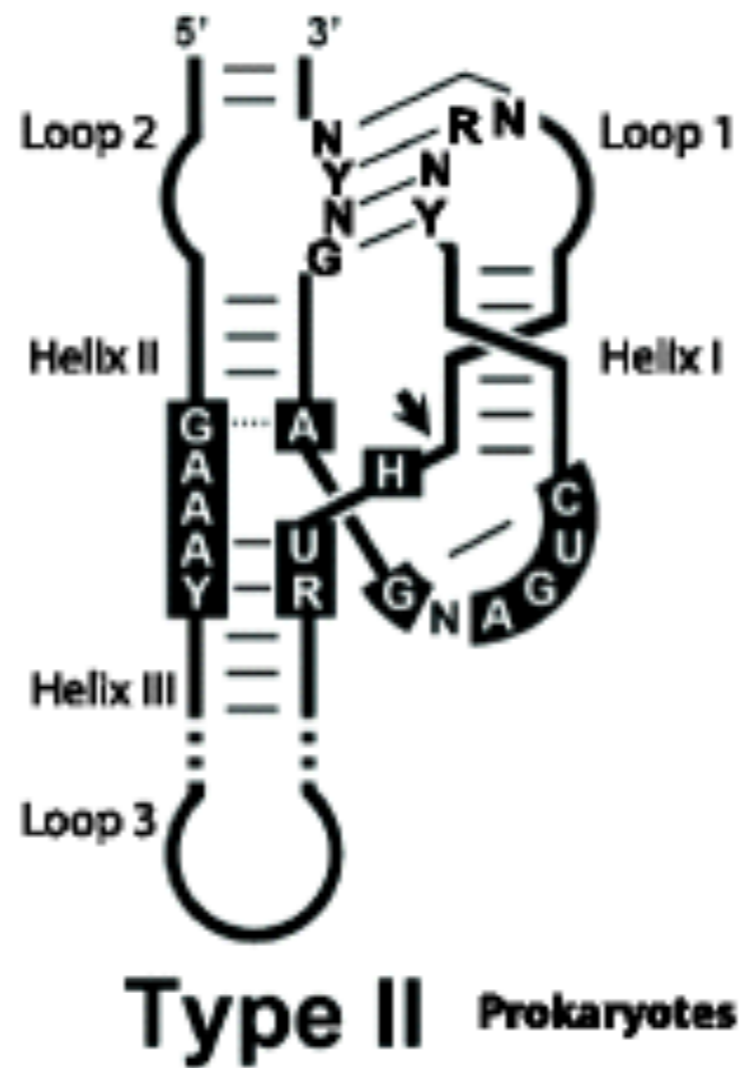
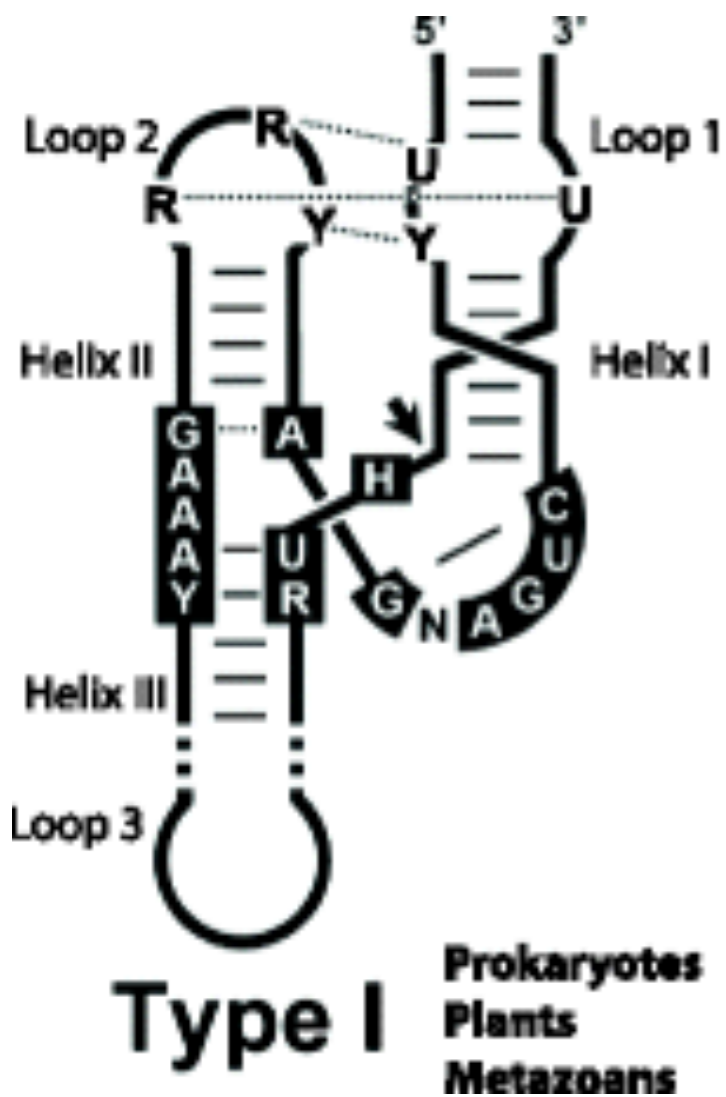



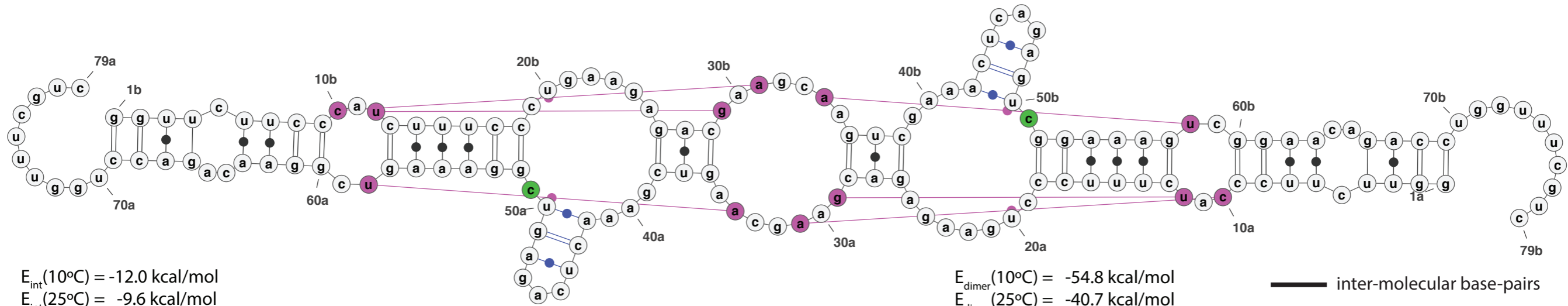

# HHR (-): symmetric dimerization



$E_{int}(10^{\circ}\text{C}) = -12.0 \text{ kcal/mol}$   
 $E_{int}(25^{\circ}\text{C}) = -9.6 \text{ kcal/mol}$   
 $E_{int}(45^{\circ}\text{C}) = -5.9 \text{ kcal/mol}$

$E_{dimer}(10^{\circ}\text{C}) = -54.8 \text{ kcal/mol}$   
 $E_{dimer}(25^{\circ}\text{C}) = -40.7 \text{ kcal/mol}$   
 $E_{dimer}(45^{\circ}\text{C}) = -22.0 \text{ kcal/mol}$

-  inter-molecular base-pairs
-  intra-molecular base-pairs
-  tertiary contacts
-  nucleotide in tertiary contact
-  cleavage site

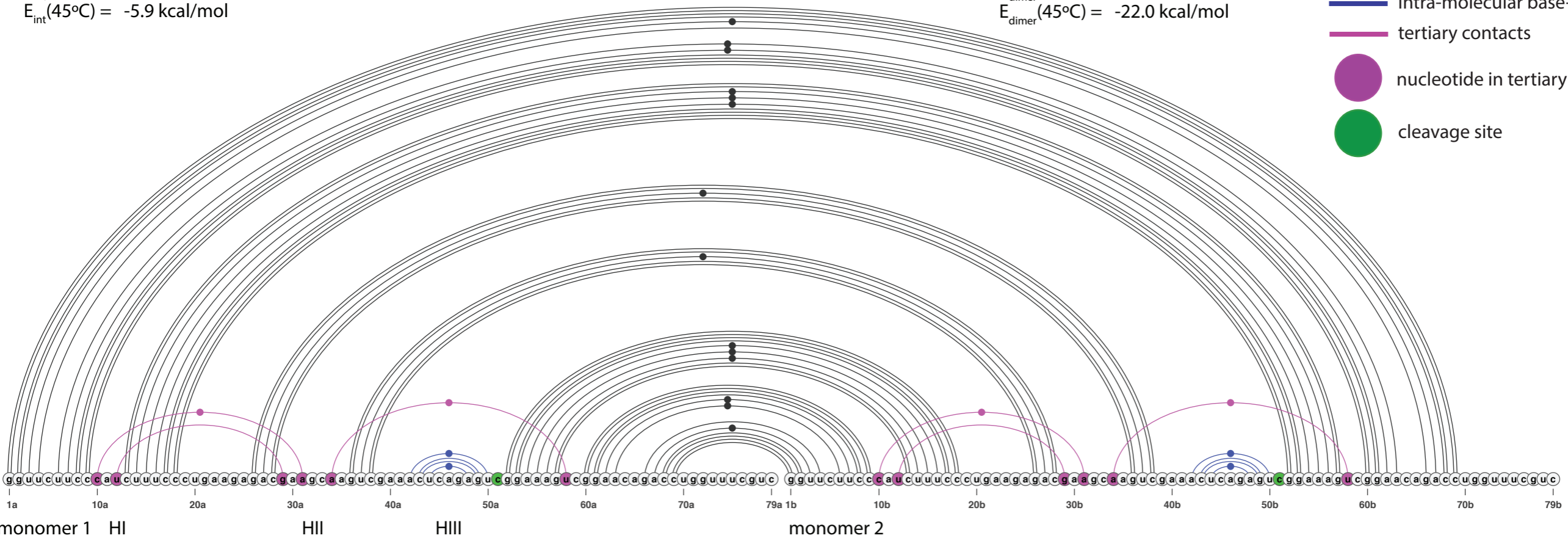

# ASBVd(-): symmetric self-association

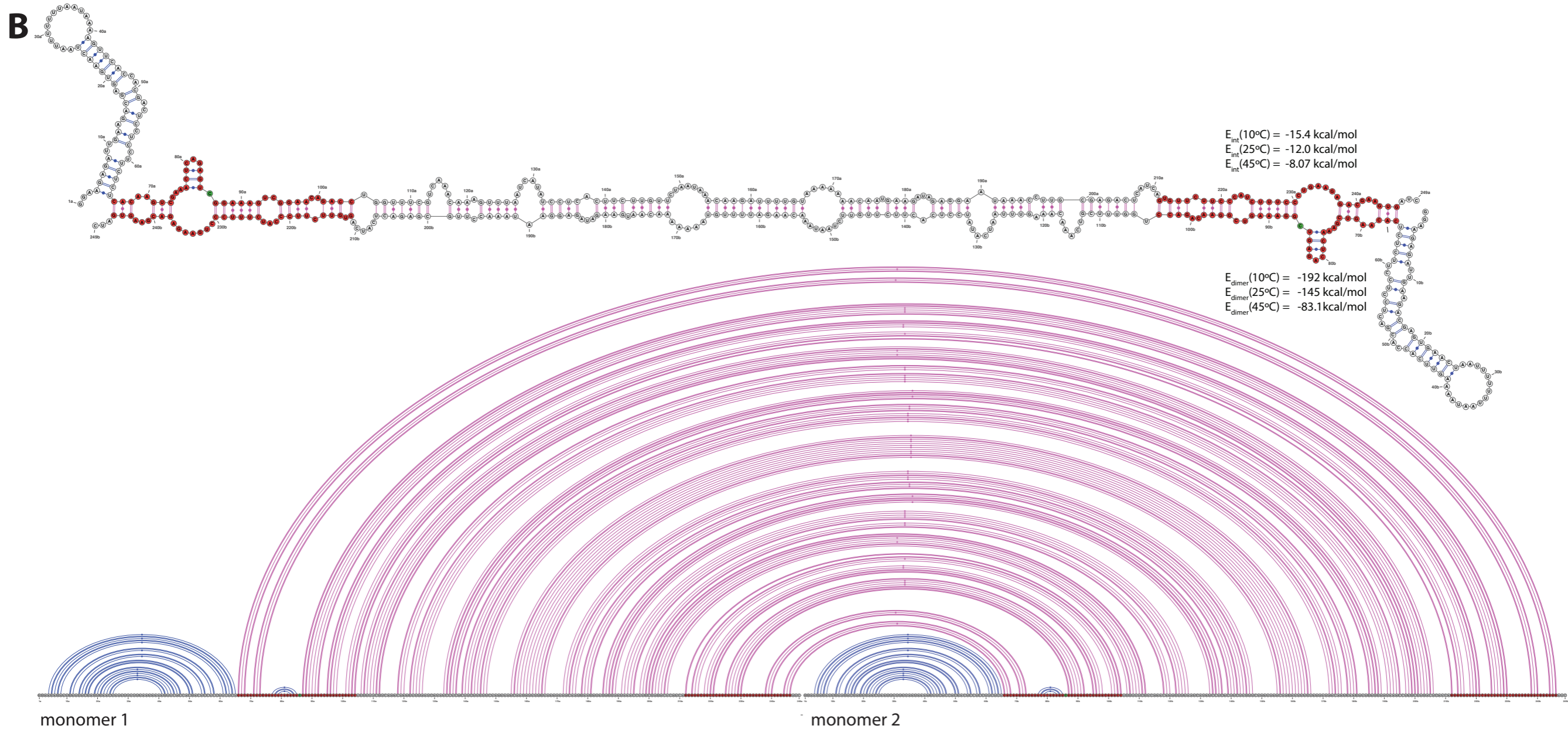

# ASBVd(-): symmetric self-association

C

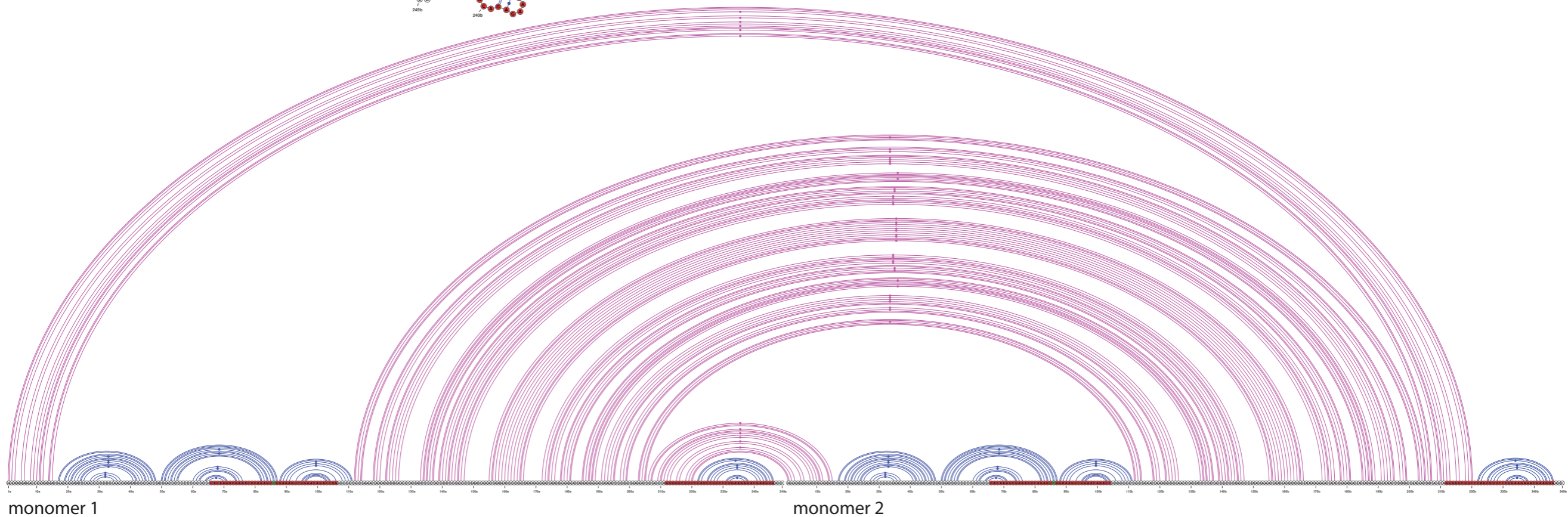
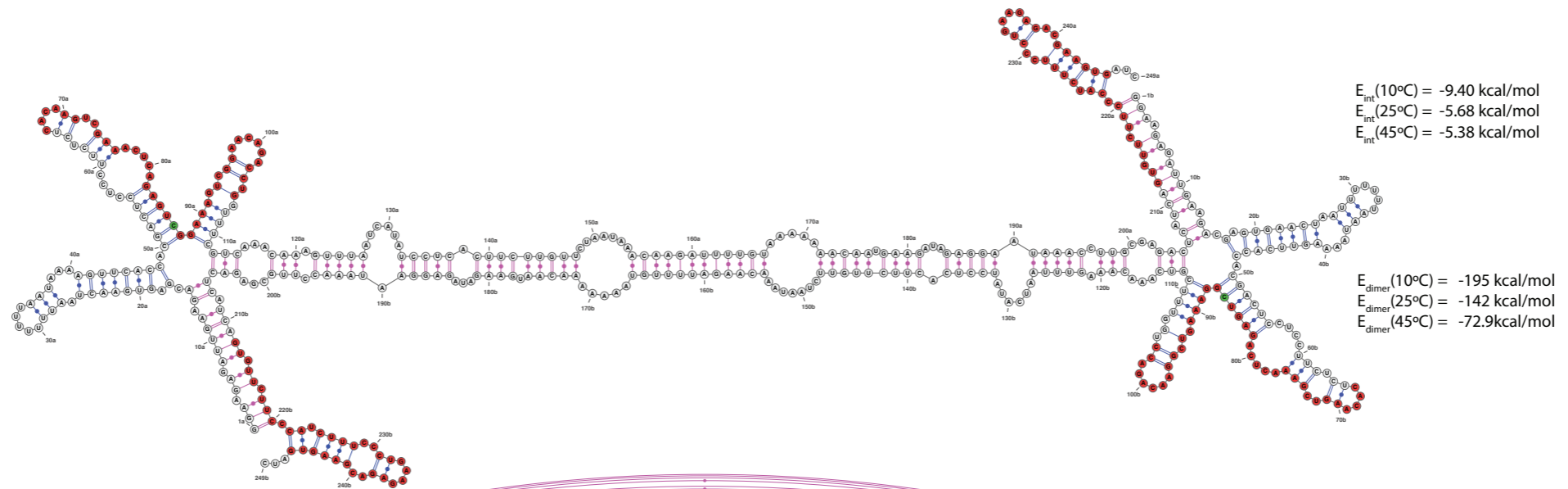

# ASBVd(-): symmetric self-association

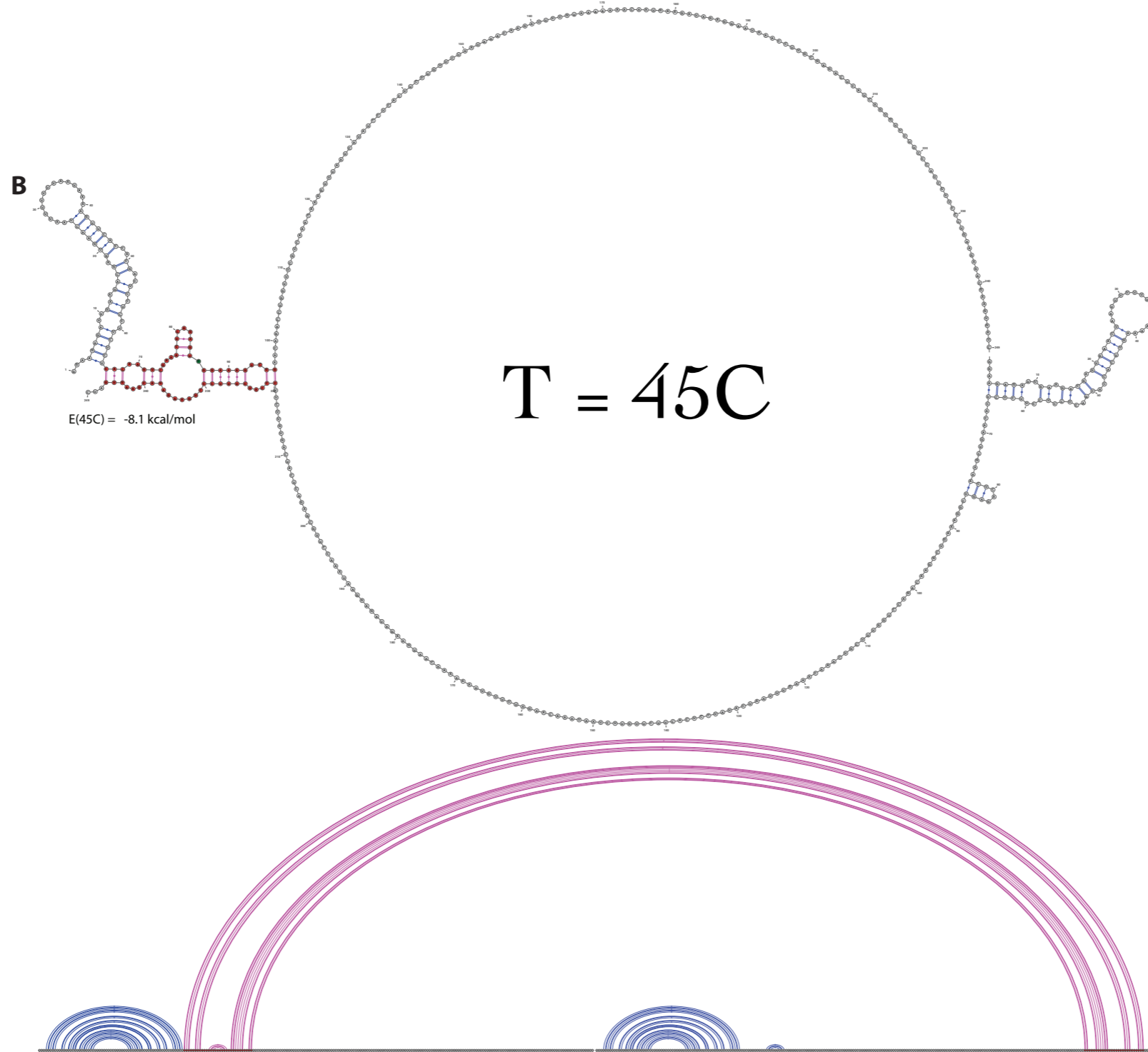

# HHR design & engineering

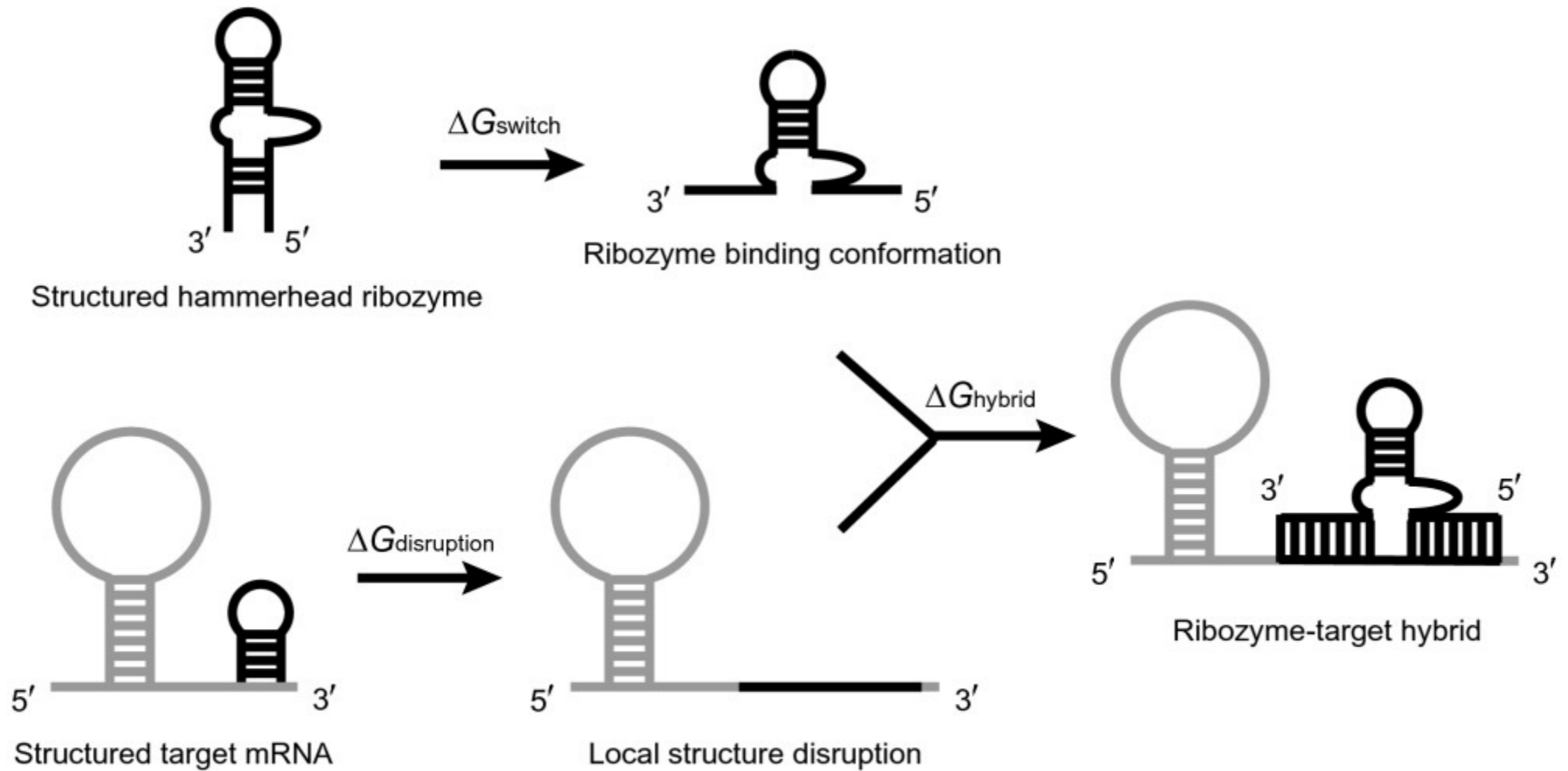



# Viroid Pathogenicity & Localization

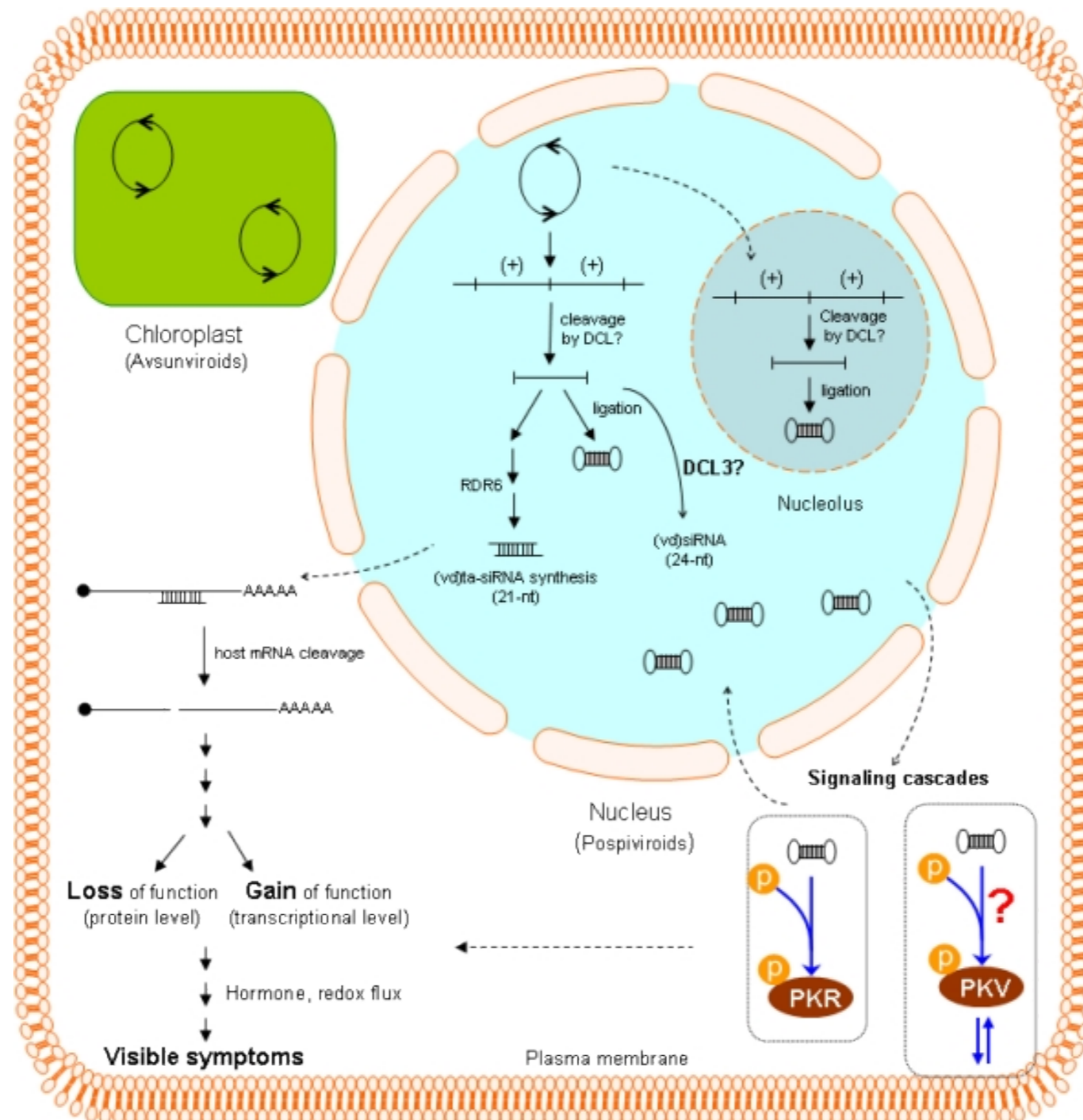

# Viroid & RNA silencing

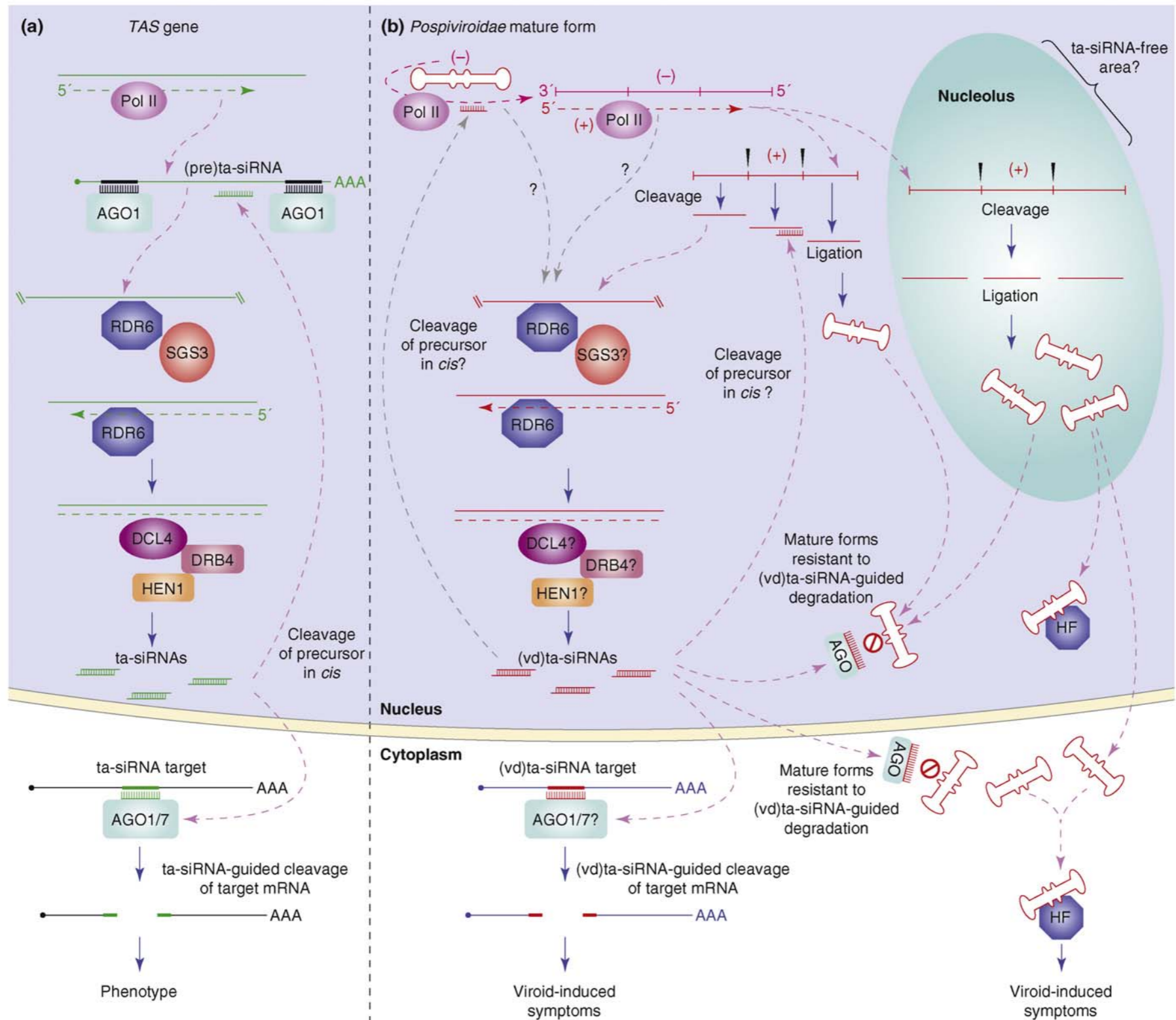

TRENDS in Plant Science

# Viroid disease symptoms

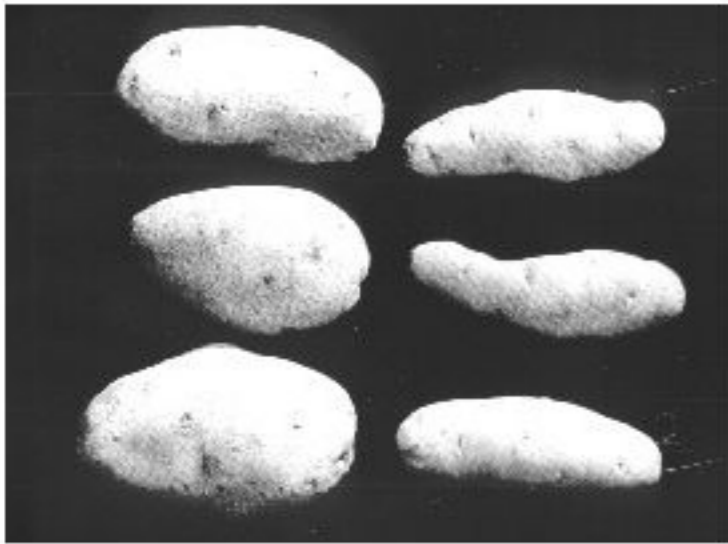

Potato spindle tuber viroid



chrysanthemum  
stunt viroid

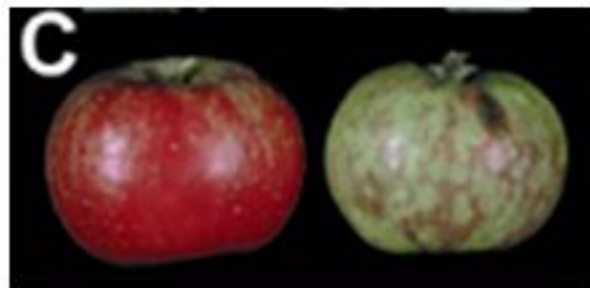

Apple viroid disease



Avocado  
Sunblotch Viroid



Coconut cadang-cadang viroid

