



**HAL**  
open science

## An intelligent irrigation system based on fuzzy logic control: A case study for Moroccan oriental climate region

Benzaouia Mohammed, Hajji Bekkay, Anne Migan-Dubois, Mellit Adel, Abdelhamid Rabhi

### ► To cite this version:

Benzaouia Mohammed, Hajji Bekkay, Anne Migan-Dubois, Mellit Adel, Abdelhamid Rabhi. An intelligent irrigation system based on fuzzy logic control: A case study for Moroccan oriental climate region. 2nd international conference on Embedded Systems and Artificial Intelligence (ESAI'21), Apr 2021, Fez, Morocco. hal-03312289

**HAL Id: hal-03312289**

**<https://hal.science/hal-03312289>**

Submitted on 2 Aug 2021

**HAL** is a multi-disciplinary open access archive for the deposit and dissemination of scientific research documents, whether they are published or not. The documents may come from teaching and research institutions in France or abroad, or from public or private research centers.

L'archive ouverte pluridisciplinaire **HAL**, est destinée au dépôt et à la diffusion de documents scientifiques de niveau recherche, publiés ou non, émanant des établissements d'enseignement et de recherche français ou étrangers, des laboratoires publics ou privés.

# An intelligent irrigation system based on fuzzy logic control: A case study for Moroccan oriental climate region

Benzaouia Mohammed <sup>1</sup>, Hajji Bekkay <sup>1</sup>, Anne Migan Dubois <sup>2</sup>, Mellit Adel <sup>3</sup>, Abdelhamid Rabhi <sup>4</sup>

<sup>1</sup> Energy, Embedded System and Data Processing Laboratory, National School of Applied Sciences, Mohamed First University, Oujda, Morocco.

m.benzaouia@ump.ac.ma

<sup>2</sup> Group of Electrical Engineering-Paris, CentraleSupélec, Paris-Sud University, Sorbonne University 3 & 11 Rue Joliot-Curie, 91192 Gif-sur-Yvette, France

<sup>3</sup> Renewable Energy Laboratory, Faculty of Sciences and Technology, Jijel University, Algeria.

<sup>4</sup> Laboratory of Modelization, Information and Systems, University of Picardie Jules Verne 3 rue Saint Leu, 80039 Amiens Cedex 1, France.

**Abstract.** Existing traditional agricultural systems consume an enormous amount of water and energy, with more than 69% of the world's freshwater volume attributed to agriculture. This fact leads to a degradation of water levels in several aquifers, as well as water quality. In Morocco, agriculture consumes about 88% of water resources, and the management of these resources is a significant issue, especially after the decline in rainfall rates in recent years. Designing an irrigation system that reduces water losses and evapotranspiration losses is the key to sustainable precision irrigation. This paper proposes an irrigation system based on an intelligent and efficient strategy for the automatic watering of agricultural areas and more adapted to the climatic conditions of Oriental Morocco. The system uses fuzzy logic to decide the duration of watering in an adaptive and precise way. Weather conditions (air temperature and solar radiation) and soil moisture (water content) are the inputs to the fuzzy system. The acquisition of these data is made by analog and digital sensors. The variables are fuzzified using trapezoidal and triangular membership functions. In the Fuzzification step, the Max-Min inference engine and the Mamdani rule base are used to decide the best decision for each given situation. The control strategy was implemented in the Arduino Uno R3 board. Typical three-day data from the summer and fall seasons were used to validate the proposed system. The simulation results showed that the proposed irrigation system maintains the soil moisture above the user-defined value and eliminates the under-irrigation risk.

**Keywords:** Smart irrigation, Irrigation strategy, Drip irrigation, Fuzzy logic, Water saving.

## 1 Introduction

The development of the agricultural sector is one of the most powerful levers to ensure economic prosperity and social stability. Morocco has placed this area in the center of its development priorities with regard to the essential economic, social, and

territorial issues raised by this sector. This sector generates about 14% of Morocco's gross domestic product (GDP). Climatic conditions (drought season) and rainfall contribute significantly to the increase or decrease of GDP [1, 2].

An efficient and appropriate provision of irrigation water leads to a significant improvement in agricultural productivity and water conservation in view of its scarcity, which has become a major global preoccupation. Irrigation and rainfall are the two major sources of water for agriculture. However, precipitation is insufficient to satisfy the plant's water needs. On the contrary, excessive moisture limits the assimilation of nutrients by plants and increases disease development risk [3]. The different irrigation control techniques that can be used are illustrated in Fig.1 and can be classified into two types: open loop and closed-loop control [4].

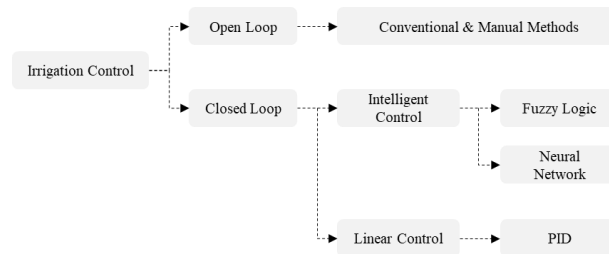

**Fig. 1.** Classification of different irrigation control techniques.

In an open-loop control system, irrigation decisions are manually made by the farmer. The operator, based on his knowledge of the perceived crop response, sets irrigation time, the volume of water to be dispensed and irrigation speed. This technique is widely used thanks to its simplicity of implementation and the absence of the necessity to use sensors. However, it can lead to over-irrigation in some areas while other areas are under-irrigated, which may cause undesirable water stress [5,6]. In addition, the losses of water and energy are considerable, which is incompatible with the general policy of the world to conserve and rationalize water resources.

Therefore, the design of an intelligent irrigation system (closed-loop control) represents an alternative and efficient solution to traditional irrigation methods. The intelligent system applies to the soil the amount of water necessary for plant growth and development while monitoring several parameters that influence irrigation performance. The control is done by feedback. The control action depends on the result, allowing the preservation of the desired output condition while comparing it to the input conditions to make the best decisions. The decisions made are generally guided by the data acquired by sensors and compared to the desired set points [7]. The main task of these systems is to accurately determine the crop irrigation needs. Table 1 summarizes recent intelligent irrigation strategies and techniques.

In this paper, an intelligent irrigation system adapted to the climate of the oriental region of Morocco has been developed. It uses feedback control based on fuzzy logic, which can also be easily integrated into drip irrigation systems without further modifying the overall system design. The system is designed to efficiently program irrigation times to maintain soil moisture above 30%. Irrigation periods are programmed in a way

that evapotranspiration times are minimal. The fuzzy controller provides the irrigation duration required for the crop according to the recorded conditions of the soil moisture, ambient temperature and solar radiation sensors. This data is then transmitted to the fuzzy controller to apply well-designed fuzzy rules to control irrigation.

**Table 1.** Summary of irrigation techniques discussed in the literature.

Techniques	Reference	Controller	Measurement Parameters	Drawbacks
Linear control	[8]	PID	Soil moisture	PID controllers are easy to implement, but are unable to control multivariable and moving processes with time delays.
	[9]			
	[10]			
Intelligent control	[11]	ANN	Soil moisture	Training data are necessary to estimate the irrigation action.
	[12]	FL	Soil moisture, Temperature, Air humidity	The measured parameters are not sufficient to decide the irrigation time precisely. Furthermore, the decision is made based on the pump's state, whether on or off, leading to over-or under-irrigation.
	[13]	FL	Soil moisture, $ET_c$ , Rain forecast, Rain forecast probability, DAP	Requires an evaluation of reference evapotranspiration ( $ET_c$ ), and the knowledge of stress and cultural coefficients ( $k_s, k_c$ ).
	[14]	FL	Soil moisture, Crop water Stress Index (CWSI), Ambient temperature, Solar Radiation, Humidity, Infrared Temperature	Multiple sensors are used which can be costly for large applications.

The structure of this paper is as follows: The first section presents the introduction of the paper. Section 2 explains the design of the studied system, section 3 deals with the mathematical modeling of the fuzzy logic controller, section 4 describes the steps of the operation of the system, section 5 discusses the obtained results and their analysis, and the last section concludes the paper.

## 2 Presentation of the irrigation system

The structure of the irrigation system is given as follow (Fig.2). The irrigation process depends on the data received from the weather station and the soil moisture sensor placed beside the plant, which is then processed by the Arduino controller. Based on the values acquired by the sensors, the fuzzy controller applies the well-designed rules

to obtain the optimal irrigation decision. Wind speed and air humidity are not taken into account because their influence on the irrigation process in the oriental region is minor.

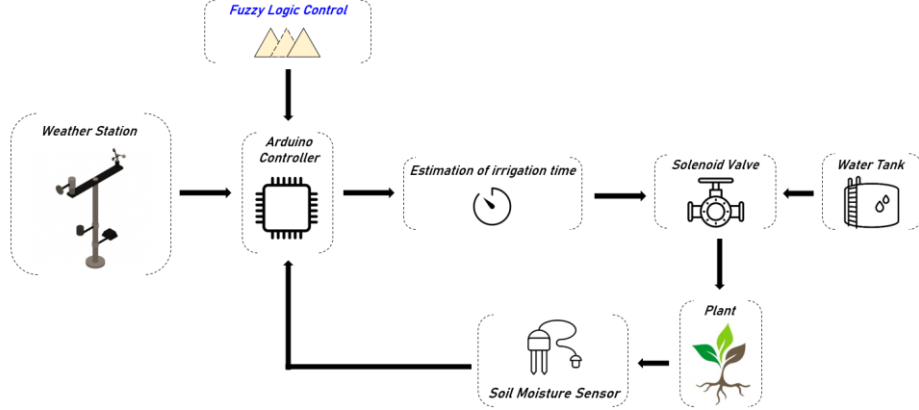

Fig. 2. Design of the proposed irrigation system.

### 3 Mathematical modeling

The proposed fuzzy logic system consists of three modules: a Fuzzification module, an Inference engine and a Defuzzification module (Fig.3) [15]. In the fuzzy logic system, a universe of discourse ( $U$ ) is developed (a membership function), and an interval of ( $U$ ) is defined by ( $mS$ ).  $mS(e)$  is defined as a membership function that is based on a set of ordered pairs of elements  $e$  and the probability that  $e$  belongs to ( $S$ ). The system takes three (3) input parameters: soil moisture ( $SM$ ), temperature ( $T$ ) and solar radiation ( $SR$ ), each parameter consists of three membership functions, which are designated by a fuzzy subset of ( $S$ ). Soil moisture is designated by a variable  $A$ , temperature is given by a variable  $B$  and solar radiation is designated by a variable  $C$ . For all three variables,  $m_A(x)$ ,  $m_B(x)$ ,  $m_C(x)$ , indicate the degree to which  $x$  belongs to variables  $A$ ,  $B$ , and  $C$ . The fuzzy intersection and the union set are given by equations (1) and (2) [16].

$$A \cap B \cap C = \{x, \min(m_A(x), m_B(x), m_C(x)) : x \in S\} \quad (1)$$

$$A \cup B \cup C = \{x, \max(m_A(x), m_B(x), m_C(x)) : x \in S\} \quad (2)$$

#### 3.1 Fuzzification Module

The Fuzzification step is designed to convert a digital input measured by a sensor into a linguistic variable based on membership functions. A membership function is a function that defines the belonging degree of a numerical input to a linguistic variable. The membership function used controls several parameters such as variations of soil moisture, temperature and solar radiation. In order to obtain the right decision, the triangular and trapezoidal membership functions represent a typical choice in the proposed irrigation system. Equation (3) and (4) shows the structure of a triangular and

trapezoidal adhesion for a three-value fuzzification system. Fig.4 and 5 shows the membership functions of the fuzzy logic controller inputs and outputs.

$$\text{trian}(x, a, b, c) = \begin{cases} 0 & , \quad x \leq a \\ \frac{x-a}{b-a}, & a \leq x \leq b \\ \frac{c-x}{c-b}, & b \leq x \leq c \\ 0 & , \quad x \geq b \end{cases} \quad (3)$$

$$\text{trap}(x, a, b, c, d) = \begin{cases} 0 & , \quad x \leq a \\ \frac{x-a}{b-a}, & a \leq x \leq b \\ \frac{d-x}{d-c}, & c \leq x \leq d \\ 0 & , \quad x \geq d \end{cases} \quad (4)$$

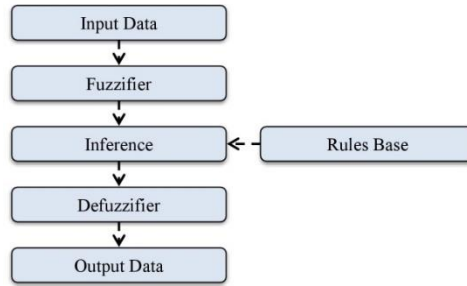

Fig. 3. Fuzzy logic controller structure.

### 3.2 Fuzzy Inference Module

Fuzzy inference allows interpreting the input values obtained from the sensors and, based on sets of rules, assigns values to the output. To achieve this, a set of if-then rules has been designed to operate with the membership functions of each input. In literature, two types of fuzzy inference systems can be implemented: Mamdani type and Sugano type. The Mamdani concept has been chosen for the proposed irrigation system since it is well suited for expert system applications. For each given scenario, the controller's output will be the irrigation duration, which varies according to the fuzzy rules grouped in Tables (2-4).

### 3.3 Defuzzification Module

Defuzzification is the last step in the process of implementing the intelligent irrigation strategy. The rules are then applied to the fuzzified values and a fuzzy output is generated, which is then converted to a scalar quantity. The centroid defuzzification method has been chosen due to its ability to provide accurate results. The defuzzified output ( $x'$ ) is expressed by Equation (5):

$$x' = \frac{\int \mu_i(x). x dx}{\int \mu_i(x). dx} \quad (5)$$

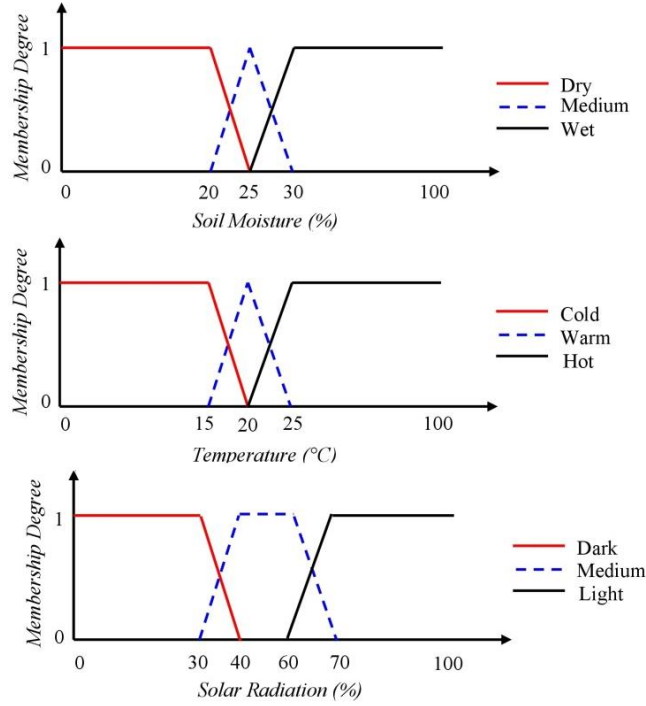

**Fig. 4.** Membership function of: a) Soil moisture, b) Temperature and c) Solar radiation (%).

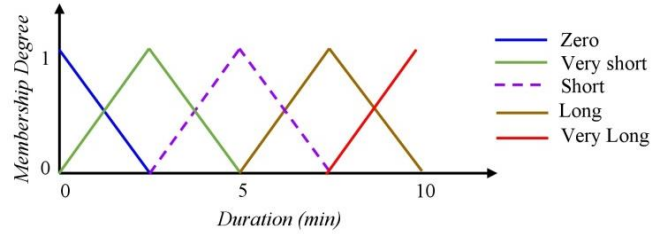
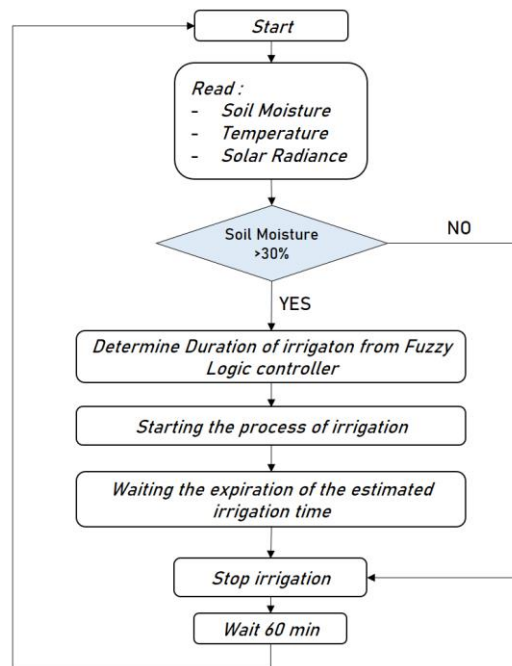

**Fig. 5.** Membership function of: Duration (min).

## 4 System Operation Steps

The operation of the irrigation system is illustrated in Fig.6. In the first step, temperature, solar radiation and soil moisture are measured in real time through the metrological station and the soil moisture sensor integrated with the plant. The second step consists of comparing the measured soil moisture value with the desired value. In case the soil moisture content is higher than 30%, the system is turned “off”; otherwise, the process of determining the irrigation duration is started and calculated by the fuzzy

controller integrated into the Arduino board. The process of aspiration of water through the soil is estimated to take about 60 minutes, so the system is programmed to wait for the same amount of time before checking the sensor values and deciding on irrigation times.



**Fig. 6.** Flowchart software of the proposed irrigation system.

**Table 2.** Rules of duration (in min) at wet soil moisture.

Temperature	Solar Radiation		
	Dark	Medium	Light
Cold	Zero	Zero	Zero
Medium	Zero	Zero	Zero
Hot	Zero	Zero	Zero

**Table 3.** Rules of duration (in min) at medium soil moisture.

Temperature	Solar Radiation		
	Dark	Medium	Light
Cold	Short	Short	Short
Medium	Short	Short	Very Short
Hot	Long	Very Short	Zero



**Table 4.** Rules of duration (in min) at dry soil moisture.

Temperature	Solar Radiation		
	Dark	Medium	Light
Cold	Very long	Very long	Very long
Medium	Long	Long	Short
Hot	Very long	Very Short	Zero

## 5 Results and Discussion

To examine and evaluate the proposed system's behavior and the irrigation strategy, an apple plant was selected. According to experts in the field of agriculture, the apple tree requires a soil moisture content above 30%. For this purpose, typical three day data from two different seasons: summer (August 2020) and autumn (November 2020) has been used. The variations of temperature and solar radiation are illustrated in Fig. 7 and Fig.8 respectively.

In the summer season the temperature varies between a maximum and a minimum of 38 °C / 19 °C, while the solar radiation reaches its maximum value around 1 Pm and 2 Pm of each day. In the fall season, weather variations are average. The temperature range is about 5°C / 20°C and solar radiation reaches 60% as a maximum value.

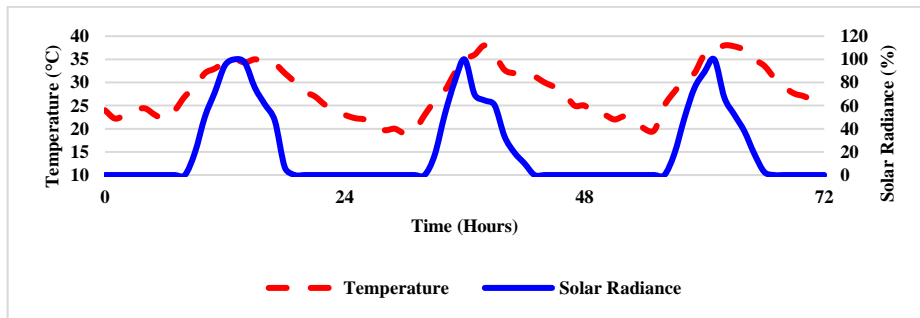
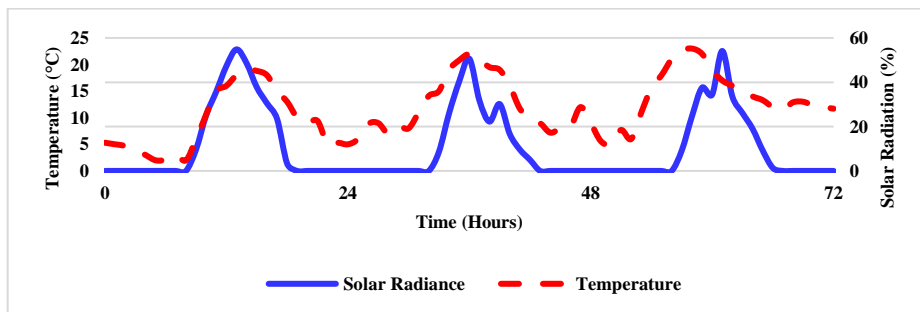
**Fig. 7.** Variation of temperature and solar radiation during the summer season.**Fig. 8.** Variation of temperature and solar radiation during the fall season.

### 5.1 During the summer season

Fig.9 and Fig.10 show that the proposed fuzzy controller avoids irrigating the plant during periods when temperatures are high (corresponds to high solar radiation), which allows reducing losses due to the phenomenon of evapotranspiration along the day, by referring to the well-designed fuzzy rules (Tables 2, 3 and 4). The system selects the appropriate times and durations for irrigation to satisfy the plants' water needs, which also allows saving water. Soil moisture is therefore maintained at the desired value (30%) (Fig.11).

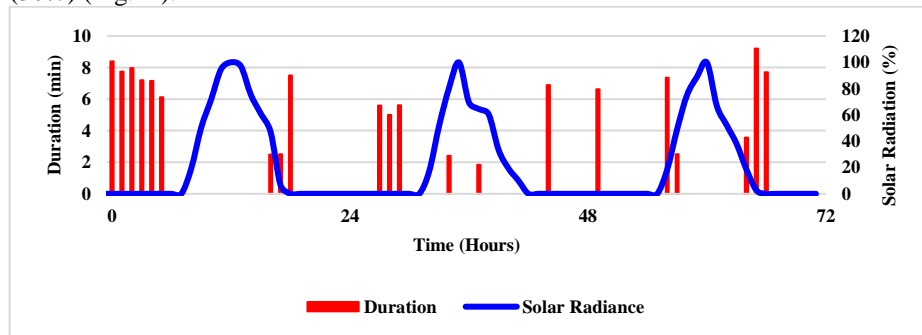

Fig. 9. Irrigation duration depending on solar radiation variation.

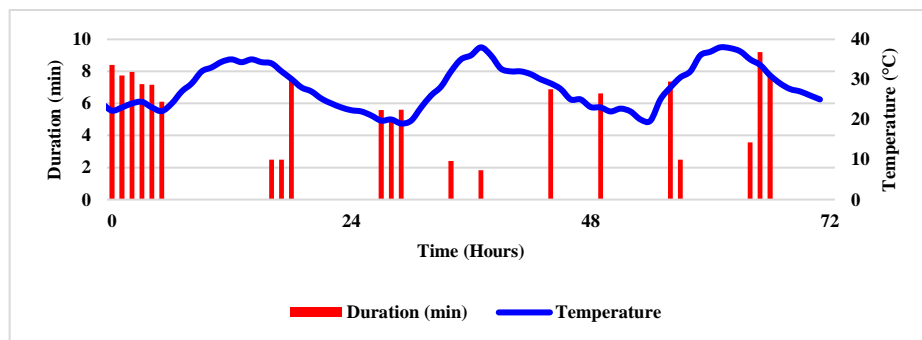

Fig. 10. Irrigation duration depending on temperature variation.

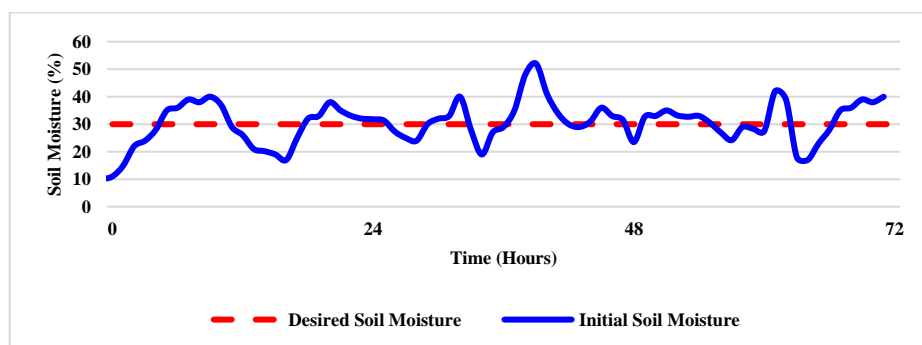

Fig. 11. Evolution of soil moisture content.

### 5.2 During the fall season

During the fall season, since temperature and solar radiation don't reach high values, the irrigation times and periods are programmed when the plant requires water, with determined durations (Fig.12 and 13). The soil moisture is also maintained at the desired value (Fig.14).

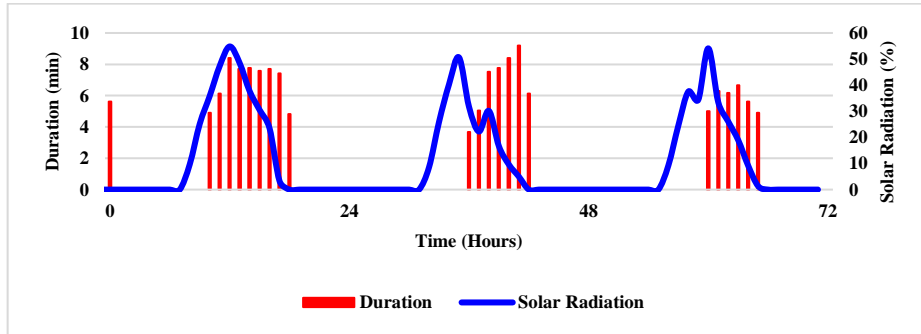

Fig. 12. Irrigation duration depending on solar radiation variation.

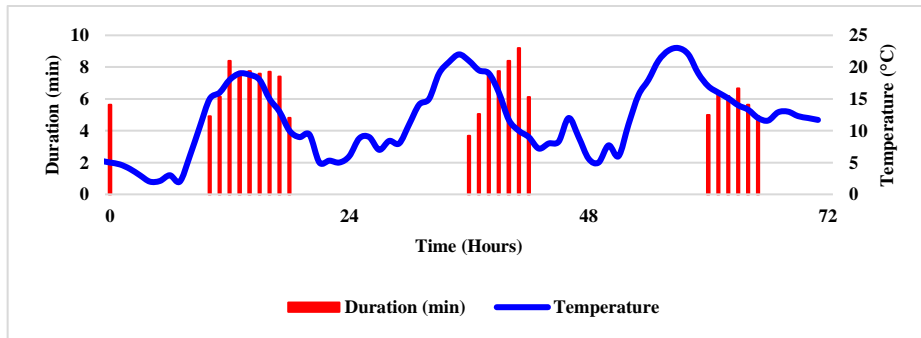

Fig. 13. Irrigation duration depending on temperature variation.

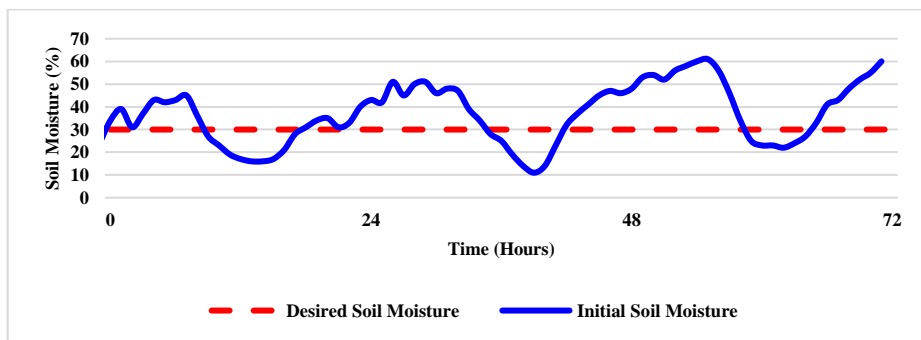

Fig. 14. Evolution of soil moisture content.

## 6 Conclusion

In this paper, closed-loop feedback control and fuzzy logic based irrigation strategy were presented to develop an optimal and sustainable irrigation approach that aims at conserving water in the oriental region of Morocco. Mamdani's Fuzzification, trapezoidal and triangular membership functions set the irrigation duration for a specific type of plants. The use of the fuzzy control maintains the soil moisture above the user-defined value and eliminates the risk of under-irrigation. The obtained results show the efficiency and reliability of the system during both summer and fall seasons.

## References

1. Abioye, E. A., Abidin, M. S. Z., Mahmud, M. S. A., Buyamin, S., Ishak, M. H. I., Abd Rahman, M. K. I., ... & Ramli, M. S. A. (2020). A review on monitoring and advanced control strategies for precision irrigation. *Computers and Electronics in Agriculture*, 173, 105441.
2. Jaiswal, S., & Ballal, M. S. (2020). Fuzzy inference based irrigation controller for agricultural demand side management. *Computers and Electronics in Agriculture*, 175, 105537.
3. Li, M., Sui, R., Meng, Y., & Yan, H. (2019). A real-time fuzzy decision support system for alfalfa irrigation. *Computers and Electronics in Agriculture*, 163, 104870.
4. Touati, F., Al-Hitmi, M., Benhmed, K., & Tabish, R. (2013). A fuzzy logic based irrigation system enhanced with wireless data logging applied to the state of Qatar. *Computers and electronics in agriculture*, 98, 233-241.
5. Benzaouia, M., Bouselham, L., Hajji, B., Dubois, A. M., Benslimane, A., & El Ouariachi, M. (2019, November). Design and Performance Analysis of a Photovoltaic Water Pumping System based on DC-DC Boost Converter and BLDC Motor. In 2019 7th International Renewable and Sustainable Energy Conference (IRSEC) (pp. 1-6). IEEE.
6. Benzaouia, Mohammed, et al. "Energy Management Strategy for an Optimum Control of a Standalone Photovoltaic-Batteries Water Pumping System for Agriculture Applications." *International Conference on Electronic Engineering and Renewable Energy*. Springer, Singapore, 2020.
7. Ma'Mun, S. R., Loch, A., & Young, M. D. (2020). Robust irrigation system institutions: A global comparison. *Global Environmental Change*, 64, 102128.
8. Romero, R., Muriel, J. L., García, I., & de la Peña, D. M. (2012). Research on automatic irrigation control: State of the art and recent results. *Agricultural water management*, 114, 59-66.
9. Goodchild, M. S., Kühn, K. D., Jenkins, M. D., Burek, K. J., & Button, A. J. (2015). A method for precision closed-loop irrigation using a modified PID control algorithm. *Sensors & Transducers*, 188(5), 61.
10. Azar, A. T., Ammar, H. H., de Brito Silva, G., & Razali, M. S. A. B. (2019, March). Optimal proportional integral derivative (PID) controller design for smart irrigation mobile robot with soil moisture sensor. In *International Conference on Advanced Machine Learning Technologies and Applications* (pp. 349-359). Springer, Cham.
11. Capraro, F., Patino, D., Tosetti, S., & Schugurensky, C. (2008, April). Neural network-based irrigation control for precision agriculture. In 2008 IEEE International Conference on Networking, Sensing and Control (pp. 357-362). IEEE.

12. Krishnan, R. S., Julie, E. G., Robinson, Y. H., Raja, S., Kumar, R., & Thong, P. H. (2020). Fuzzy Logic based Smart Irrigation System using Internet of Things. *Journal of Cleaner Production*, 252, 119902.
13. Aquino-Jr, P. T., Maia, R. F., Kamienski, C., & Soininen, J. P. A fuzzy irrigation control system.
14. Jamroen, C., Komkum, P., Fongkerd, C., & Krongpha, W. (2020). An Intelligent Irrigation Scheduling System Using Low-Cost Wireless Sensor Network Toward Sustainable and Precision Agriculture. *IEEE Access*, 8, 172756-172769.
15. Zerouali, M., Zouirech, S., El Ougli, A., Tidhaf, B., & Zrouri, H. (2019, November). Improvement of Conventional MPPT Techniques P&O and INC by Integration of Fuzzy Logic. In 2019 7th International Renewable and Sustainable Energy Conference (IRSEC) (pp. 1-6). IEEE.
16. Zerouali, M., El Ougli, A., Tidhaf, B., & Zrouri, H. (2020, December). Fuzzy logic MPPT and battery charging control for photovoltaic system under real weather conditions. In 2020 IEEE 2nd International Conference on Electronics, Control, Optimization and Computer Science (ICECOCS) (pp. 1-5). IEEE.
17. Soulis, K. X., & Elmaloglou, S. (2018). Optimum soil water content sensors placement for surface drip irrigation scheduling in layered soils. *Computers and electronics in agriculture*, 152, 1-8.