



HAL
open science

Multi-scale approach to assess the impacts of land use evolution and rainwater management practices on the hydrology of periurban catchments. Application to the Yzeron catchment (150 km²)

M. Labbas, F. Branger, I. Braud, S. Kralisch, C. Jacqueminet, S. Kermadi, K. Michel, T. Joliveau, C. Dodane, E. Volte

► To cite this version:

M. Labbas, F. Branger, I. Braud, S. Kralisch, C. Jacqueminet, et al.. Multi-scale approach to assess the impacts of land use evolution and rainwater management practices on the hydrology of periurban catchments. Application to the Yzeron catchment (150 km²). Novatech 2013 - 8ème Conférence internationale sur les techniques et stratégies durables pour la gestion des eaux urbaines par temps de pluie / 8th International Conference on planning and technologies for sustainable management of Water in the City, Jun 2013, Lyon, France. hal-03303538

HAL Id: hal-03303538

<https://hal.science/hal-03303538>

Submitted on 28 Jul 2021

HAL is a multi-disciplinary open access archive for the deposit and dissemination of scientific research documents, whether they are published or not. The documents may come from teaching and research institutions in France or abroad, or from public or private research centers.

L'archive ouverte pluridisciplinaire **HAL**, est destinée au dépôt et à la diffusion de documents scientifiques de niveau recherche, publiés ou non, émanant des établissements d'enseignement et de recherche français ou étrangers, des laboratoires publics ou privés.

Multi-scale approach to assess the impacts of land use evolution and rainwater management practices on the hydrology of periurban catchments. Application to the Yzeron catchment (150 km²)

Approche multi-échelles pour étudier les impacts de l'évolution de l'occupation du sol et de la gestion des eaux pluviales sur l'hydrologie de bassins versants périurbains. Application au bassin de l'Yzeron (150 km²)

Mériem Labbas¹; Flora Branger¹; Isabelle Braud¹; Sven Kralisch²; Christine Jacqueminet³; Saïda Kermadi³; Kristell Michel³; Thierry Joliveau⁴; Clément Dodane⁴; Emmanuelle Volte⁵

¹ Irstea, UR HHLY, 5 rue de la Doua, 69100 Villeurbanne, France corresponding author: meriem.labbas@irstea.fr. ² Department of Geoinformatics, University of Jena, Löbdergraben 32, 07743 Jena, Allemagne. ³ Université de Lyon, UMR CNRS EVS, 18 Rue Chevreul, 69363 Lyon Cedex 7, France. ⁴ Université de Saint-Etienne, UFR SHS, 33, Rue du 11 Novembre, 42023 Saint-Etienne Cedex 2, France. ⁵ Grand Lyon, Direction de l'eau, Unité Etudes générales et modélisation, 117 boulevard Marius Vivier Merle, 69003 Lyon, France.

RÉSUMÉ

L'artificialisation des milieux, engendrée par l'évolution de l'occupation du sol et par la modification des chemins d'écoulement, induit des changements de l'hydrologie des bassins versants. Pour aider les gestionnaires à évaluer la vulnérabilité de leur territoire en situant les différents enjeux en terme de gestion des eaux pluviales et d'aménagement, une méthodologie basée sur une approche multi-échelles de modélisation hydrologique spatialisée est proposée.

L'objectif est de quantifier l'impact de l'évolution de l'urbanisation et de la gestion des eaux pluviales sur le cycle hydrologique d'un bassin versant de taille intermédiaire (150 km²), sur de longues périodes. La méthode décrite s'appuie sur plusieurs outils : un modèle hydrologique spatialisé adapté aux spécificités du milieu périurbain, des données cartographiques d'occupation et d'usages du sol à différentes dates (passé, présente, future) et des informations sur la gestion des eaux pluviales recueillies auprès des gestionnaires. Le cas d'étude présenté est le bassin versant périurbain de l'Yzeron situé à l'ouest de Lyon (France).

ABSTRACT

The anthropogenic influence or "artificialization" generated by land use evolution and water flow paths modifications induces changes in the hydrology of watersheds. To help stakeholders to assess the vulnerability of their territory by addressing different rainwater management and planning issues, a methodology based on a multi-scale distributed hydrological modelling approach is proposed.

The objective is to quantify the impact of ongoing urbanization and stormwater management on the long-term hydrological cycle of a medium-sized watershed (150 km²). The described method relies on several tools and data: a distributed hydrological model adapted to the characteristics of periurban areas, land use and land cover maps from different dates (past, present, future) and information about rainwater management collected from local authorities. The case study area is the Yzeron periurban catchment, located near Lyon (France).

KEYWORDS

Distributed hydrological modelling, Long term water balance, Land use change, Rainwater management.

1 INTRODUCTION

Many studies showed the impact of artificialization on hydrology and ecology (Leopold, 1968; Walsh et al., 2005). Growing urbanization increases the imperviousness of previously natural or agricultural surfaces. The evolution of rainwater management leads to the development of artificial channels such as sewer networks, roads and ditches. In addition, some sustainable drainage systems such as infiltration ditches and retention basins are set up to slow down surface runoff. Sewer overflow devices are installed in combined sewer systems and deliver water, often polluted, to the river. All of these anthropogenic modifications influence the natural water flow paths and the water balance of catchments. As a result, several authors report an increase of surface runoff, a rise of storm peak flows and flood magnitude, a reduction of groundwater recharge and increasing water pollution (O'Loughlin et al., 1996 ; Beighley and Moglen, 2002 ; Burns et al., 2005, etc.).

Medium-sized periurban catchments (~ 100-150 km²) are particularly subjected to fast anthropogenic modifications (Braud et al., 2013). These catchments consist of a combination of natural areas, rural areas with dispersed villages and urban areas mostly covered by built zones and spots of natural surfaces. Their boundaries are not so easy to define as they depend on both topography and rainwater management (Jankowsky et al., 2012). In the context of the European Water Framework Directive (2000) and the Floods Directive (2007), extensive knowledge of the long-term hydrological dynamics of periurban catchments is required in order to find integrated and perennial solutions to reduce flooding and river pollution at the scale of urban conglomerations or whole catchments.

Distributed hydrological modelling is a well-recognized tool to quantify the anthropogenic alterations of the water cycle of medium-sized catchments and thus to develop rainwater management solutions at the appropriate scale. As they can take into account the heterogeneity of periurban areas, distributed models allow the determination of the main origins of water flow and the localization of the areas vulnerable to flooding and pollution. Long-term simulations provide an appraisal of river regime changes and allow the evaluation of potential scenarios for future actions. However, the temporal dynamics and the spatial scale of hydrological processes in urban and rural areas are very different and the complex interaction of both land use types is thus not easily modelled. Many hydrological models exist and most of them are designed either for urban or rural areas. In general, urban models focus on the hydraulic routing inside sewer systems and rural models on runoff generation. Few models are especially dedicated to medium-sized periurban catchments, although they are required in order to quantify the impact of modifications of land use and rainwater management on the hydrological cycle over a long time period. To address this question, we propose a methodology based on a multi-scale distributed modelling approach. We first describe the general concepts of the method. Then, we present one application to the Yzeron catchment study area, with an adapted model called J2000P, and the first results obtained in the framework of this on-going project.

2 CONCEPTS AND METHODOLOGY

In order to model both urban and rural water cycles at medium scales, the main elements existing in periurban areas and defined by a kind of land use and rainwater management must be first identified as well as the dominant hydrological processes they generate. This demands for a global understanding and formalizing of small-scaled (few ha to few km²) periurban hydrological processes which are then to be organized into a hierarchy. To model the long-term hydrology of medium-scaled periurban catchments, an appropriate model has to be developed or an existing one should be adapted. This model has to take into account the main elements and processes identified during the previous steps, at the appropriate temporal and spatial scales. To assess the ability of the model to simulate the long-term periurban hydrology, the model has to be evaluated using observed data. Then, it can be used for evaluating the impacts of different past and future hydrological management scenarios, based on collected knowledge of land use/land cover and rainwater management practices.

2.1 Defining a “periurban typology”

Water production and routing depend on land use and rainwater management practices. To identify the main hydrological elements that influence the hydrological processes and should be represented in the model, we propose to establish a land use and rainwater management typology, based on the analysis of the available information for different dates. This “periurban typology” has to take into account the different types of land use such as forests, agricultural areas, large properties, farms, dense urban city centres, residential buildings, industrial areas, etc. According to their typical rainwater management practices (combined sewer system, rainwater network, agricultural drainage,

combination of different techniques, no rainwater management, etc.), these types of land use are grouped together or are separated to obtain classes of similar hydrological properties (runoff generation and runoff connectivity): impervious surfaces connected to the sewer network, to the river, to a storage or to a permeable surface, pervious surfaces, etc.

Thereafter, this classification is used for the construction of hydrological response units (HRUs; Flügel, 1995). These units represent “hydrologically homogeneous” areas characterized by a similar hydrological process response to climatic input. The runoff generation is related to physical parameters depending not only on land use and rainwater management practices but also on geologic and pedologic characteristics. The knowledge of these properties allows the assessment of the partition between the interception, the evapotranspiration, the infiltration and the runoff components of each HRU. Due to their ability to route generated runoff to different neighbouring elements, HRUs are an appropriate representation to take into account the modification of water flow paths by artificial channels in periurban catchments. According to its land use and rainwater management, each HRU can be connected to the river network, the sewer system or a neighbouring element in different ways. For instance, to calculate the surface runoff produced by one HRU and identify its receivers, one needs to know both the percentage of impervious surfaces and the percentage of these surfaces connected to an artificial drainage system. Finally, different kinds of HRUs are obtained. For example, a HRU made up of dense urban areas connected to combined sewer networks produces mainly surface runoff and clear water infiltration into the sewer network. Then, depending on whether or not the waste water treatment plant is within the catchment, the water balance is modified. Another HRU made up of residential areas connected to a separated sewer network can transfer its runoff more or less directly to the river depending on its rainwater management.

2.2 Process representation using a multi-scale approach

The second step of the method aims at improving the representation of hydrological periurban processes to model the long-term regime of medium-sized periurban catchments. To simplify the complexity of the hydrological processes occurring at the scale of medium catchments, small-scaled hydrological processes are identified and organized into a hierarchy. Only the main processes are to be implemented at the larger target scale. For this purpose, the results of existing detailed hydrological simulations, obtained at smaller scales (districts or small-sized catchments) and described in the literature are analyzed and synthesized. In particular, two detailed models have been already identified: URBS and PUMMA.

URBS is an object-oriented model (Rodriguez et al., 2008) which describes the runoff generation using a detailed spatial description of urban areas. The sewer system and each cadastral unit, including their buildings, gardens and adjacent streets, are represented explicitly. A module describing sustainable rainwater systems was also implemented. This model is used to assess the modification of water pathways due to the introduction of sewer networks. It was already applied to two small catchments, Gohards (180 ha) and Rezé (5 ha), France. The second model is the distributed PUMMA model (Jankowsky, 2011) which uses an object-oriented and modular approach to describe periurban areas. It consists of a combination of two models within a modelling framework : URBS for the modelling of urban objects and BVFT (Bassin Versant Fontaine du Theil, Branger, 2007) for the modelling of rural objects such as agricultural fields and forested areas. PUMMA was already applied to the Chaudanne catchment (4.1 km²) located in the Yzeron catchment, France. The results of long-term simulations on this catchment already showed the importance of urban influenced processes on the hydrological response, in particular surface runoff generation on impervious and natural urban areas and infiltration into the sewer system. The connection of urban areas to the natural river was also pointed out to be a key parameter for periurban catchments modelling.

After this understanding step, the dominant hydrological processes and objects defined during the previous steps have to be implemented in a larger scaled model. This model has to be able to simulate the modifications caused by urban areas on runoff generation and water routing. For example, Braud et al. (2013) showed that a periurban catchment of 150 km² can have a response time of 12 hours. So, in order to better represent the faster responses of urban areas, the modelling time step has to be less than one day. Branger et al. (2013) found that the simulation of the water balance of the same catchment with a distributed model resulted in an overestimation of the discharge in urbanized subcatchments. The absence of sewer representation and an overestimation of the runoff coefficients were assumed to be mainly responsible for these results and thus should be changed. Finally, the representation of hydrological processes must also be thought depending on the periurban topology. As mentioned before, each HRU represents specific hydrological properties. The dominant processes occurring within these units depend on their percentage of imperviousness, vegetation, type

of drainage and also on the connection of the different land uses to the routing channels. This last point must be taken into account in the model.

2.3 Model set up and evaluation

In distributed modelling, the first step consists of the spatial discretization required by the selected model. Here, we propose a discretization based on the HRU concept and the periurban typology established previously. The delineation of each HRU depends on the land use, rainwater management, soil, geology, aspect and slope criteria of the study catchment. The connections between HRUs, the river network and the sewer networks can be determined in reference to the rainwater management so that the topology can take into account the modifications of water flow paths caused by artificial channel networks. For this purpose, the periurban catchment delineation method of Jankowsky *et al.* (2012) can be used. It takes into account both topography and water flow path modifications due to the sewer system to define catchments boundaries. This method was already applied to the Yzeron catchment for the delineation of artificial and natural subcatchments (Branger *et al.*, 2012; 2013). The HRU segmentation has also to be adapted to the simulation time step and the identified dominant processes. The second step is the specification of model parameters based on the existing information. As there is a close relationship between parameter values and the available measured data, an additional calibration of model parameters is not necessary (Branger *et al.*, 2013).

Then, the model's ability to simulate the most important hydrological processes within the catchment must be assessed. The verification can be done based on present land use and rainwater management state, using several years of climate forcing time series. For a better evaluation, the simulation results are compared with observed discharge at different nested gauging stations located along the natural and artificial channel networks. A set of performance indicators can be used to quantify these results and hydrological signatures can be extracted from the hydrological series to characterize the global regime, high flows, low flows and seasonal flows (Braud *et al.*, 2013).

Finally, once the model is validated, it can be used to test the effects of different past and future land use and rainwater management scenarios on the catchment hydrology. These scenarios can be built based on land use maps and the analysis of the evolution of rainwater management. Different assumptions about the rainwater management can also be used to build scenarios of potential future development. Depending on the density of impervious areas, various hypotheses concerning the presence or absence of combined and rainwater sewer systems, as well as the existence of sustainable drainage systems, can be tested. To assess the hydrological impacts of these scenarios, different model output variables are of interest: evapotranspiration and water soil storage, total discharge and its components (surface runoff, interflow, base flow) at the artificial and natural outlets of the whole catchment or various subcatchments. Flow separation hydrographs and filtering methods (Willems, 2009) can be used to compare the simulated and observed components of the urban and rural flows.

3 APPLICATION SITE AND AVAILABLE DATA

3.1 Presentation of the Yzeron catchment

The method is applied to the medium-sized Yzeron catchment (150 km²), located in the Southwest of Lyon, France (Figure 1). This catchment is representative for French periurban areas and is characterized by a contrasted topography and a changing land-use. Upstream, the hills culminating at 917 meters are mainly covered by forests on steep slopes. The middle part consists of urban nuclei surrounded by grassland and cultivated lands. Downstream, there are densely urbanized zones and the altitude reaches 162 meters at the outlet of the catchment, the Rhône river. Since the 1980's, a fast growing of urbanization has been observed at small urban centres and along the road networks (Cottet, 2005 ; Gnouma, 2006; Radojevic *et al.*, 2010). The analysis of digitized aerial photographs and satellite images showed an increase of impervious areas (Kermadi *et al.*, 2013). The catchment is also characterized by a limited soil water storage capacity due to its geology: crystalline rock (granite and gneiss) in the western part and alluvial and glacier formations in the eastern part. The climate is temperate, with continental and Mediterranean influences. The watershed receives annually about 830 mm of precipitation (www.meteofrance.fr, 2012). Due to steep slopes upstream and a low soil water storage capacity, quick Mediterranean-type floods can occur and impact the urbanized areas downstream.

The Yzeron catchment is a part of the Field Observatory for Urban Water Management (OTHU, 2012). As such, it is very well-documented over a long time period.

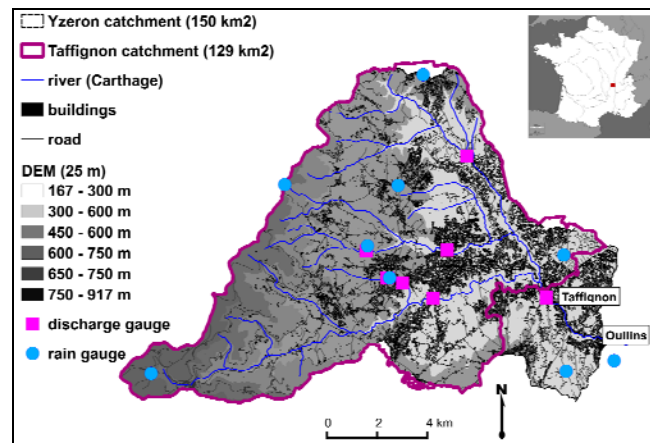

Figure 1 : Situation map of the Yzeron and Taffignon catchments with indications of topography, river networks, urbanized areas (roads and built areas), rain and discharge gauges. The borders of the Yzeron catchment match the topographical borders derived from the DEM whereas the delineation of the Taffignon catchment also takes into account the modification of water flow paths due to stormwater and combined sewer systems.

3.2 Hydrological and meteorological data

A network of measurement stations was set up over the catchment providing quite long time series of both precipitation and discharge (Figure 1). Four rain gauges monitoring precipitation with a 6 min time step have been managed by the Grand Lyon since 1985. Since 1997, Irstea manages complementary rain gauges using a variable time step. The streamflow measurement follows a strategy of nested subcatchments from 2 km² to 129 km², with varying land-uses. Discharge stations are maintained by DREAL Rhône Alpes and Irstea, and provide data with a variable time step at different subcatchments, some of them nested, since 1970. In addition, discharge data coming from the outlets of sewer overflow devices have been collected by Irstea since 2001 in the Chaudanne subcatchment and by the SIAHVY, an association of municipalities monitoring sewer networks, since 2010. The climatic data were derived from the SAFRAN reanalysis database (Vidal *et al.*, 2010) provided by Météo-France over a 8*8 km² grid from 1970 to 2011 at an hourly time step. This data set is used for the computation of the reference evapotranspiration (ET₀) following the FAO (1998) method.

3.3 GIS data and urban database

A digital elevation model (DEM) from BDTopo@IGN is available with a 25 m resolution. A geological map of the region at the 1:50000 scale was digitized by Gnouma (2006). The pedological map comes from the French DONESOL programme (SIRA, 2012). The French national database BDCarthage provided maps of the river network. In the framework of the AVuPUR (Assessing the Vulnerability of Peri-Urban Rivers) project (Braud *et al.*, 2010), past, present and future land use maps from 1945 to 2030 were produced using different remote sensing images: BDOortho@IGN aerial photographs, QuickBird satellite images and Spot satellite images (Jacqueminet *et al.*, 2013), and territorial prospective (Dodane *et al.*, 2010). Land use maps are available for 1945, 1970, 1990 and 2008 and land cover maps for 1990, 1999, 2008 (Figure 2). In 2008, the catchment was covered by 25 % of impervious surfaces, 42 % of agricultural areas and 33 % of forests. Maps of future land use scenarios provide different perspectives of urbanization. The maps of the sewer networks were obtained from local authorities (Grand Lyon and SIAHVY, Figure 3). The associated data are the localization of sewer pipes and pumping stations, the flow directions, the type of pipes (combined or separate systems for waste water and rainwater) and their diameter, and the localization of waste water treatment plants (WWTP). There are two local WWTP within the basin, in the municipalities of Yzeron (since 2011) and Saint-Laurent-de-Vaux (since 2012), but most of the rainwater collected by combined sewer systems goes to a WWTP outside of the catchment (Pierre-Bénite).

3.4 Elements on rainwater management

From the information that could already be gathered, the rainwater management of the Yzeron catchment is divided into three zones: the eastern part managed by the local authority Grand Lyon (GL), the western part managed by the sanitation syndicate SIAHVY and some municipalities which keep their rainwater responsibility (e.g., programming and financing of rehabilitation works). In urban areas, rainwater is in most cases directed to the WWTP using Combined Sewer System (CSS). In some places, the houses are not connected to a sewer system and infiltrate their rainwater directly on-

site.

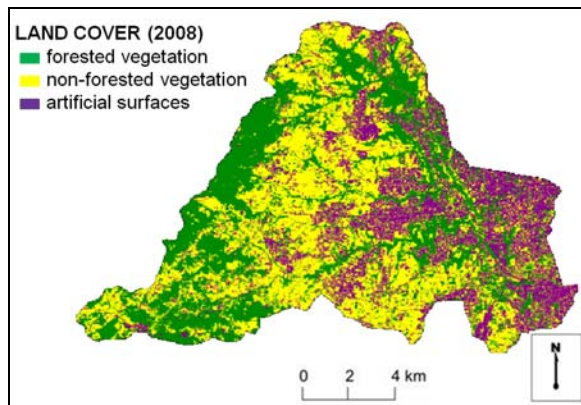

Figure 2 : Land cover map provided by the analysis of SPOT images (2008).

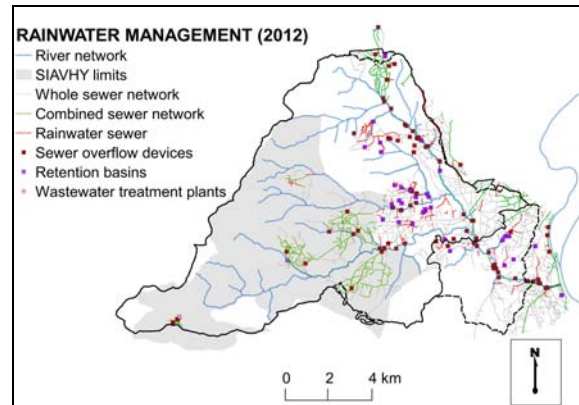

Figure 3 : Map of the present rainwater management on the Yzeron catchment.

The rainwater management is mainly influenced by the policy of GL which manages the principal drain of the sewage disposal and the main WWTP at Pierre-Bénite. An agreement made between the GL and the cities in the catchment sets a theoretical maximum discharge which passes through the main drain (for e.g., 110 L/s for Brindas and 90 L/s for Vaugneray). Since 1995, GL has been carrying out an active rainwater management policy which is followed by almost each local authority of the different cities of the catchment. It recommends that all rainwater falling on a newly built place should not reach a sewer system. In most cases, it is advised to let the rainwater infiltrate on-site using a retention basin or a seepage well. If this is not possible, which can be the case on the Yzeron catchment where the soil water storage is very limited, the rainwater can be connected to a natural or separate network after retention (e.g. underground tank). The acceptable discharges are 10 L/s/ha in case of a disposal into a ditch or a separate sewer system and 5 L/s/ha in case of a disposal into a combined sewer system. In the old sewer systems, retention basins and SODs were installed. Finally, a project of a rainwater tax has been studied by GL in order to encourage industrial and private owners to disconnect their rainwater from the CSS. This is still not implemented but it offers various guidelines for the design of future rainwater management scenarios.

4 MODELLING TOOL AND FIRST RESULTS

4.1 Model choice

The model chosen for the application of the method described in section 2 is a periurban version of the J2000 model (Krause et al., 2006), called J2000P. J2000 is a modular, open-source model available through the JAMS modelling framework (Kralisch et al., 2007). It is thus freely available, new simulation components can be easily developed and integrated to adapt the model to the requirements of periurban catchments (see Section 4.3). J2000 is a fully-distributed hydrological model, which was developed for continuous long-term modelling of meso- and macro-scale rural catchments. It simulates hydrological processes on irregular meshes based on the concept of HRUs. As mentioned in section 2.3, the HRU discretization allows to cope with the heterogeneity of urban areas and in particular with the fact that flows are not only governed by topography but also by artificial networks (sewer, ditches, roads, etc.). Up to now, J2000 has been mainly used at a daily time step but the model can be run at any fixed time step.

4.2 Water production and routing in J2000

In J2000, hydrological processes are simulated on irregular HRUs. Five main components describe the following physical processes: interception, evapotranspiration, infiltration/surface runoff partition, soil diffusion and percolation, groundwater flow and stream flow (Figure 4). At each time step, the model simulates these processes for each HRU. The outflows are then routed laterally to the connected neighbouring HRU or river reach, according to the topology. The infiltration/surface runoff partition is controlled by the surface sealed grade, the average soil saturation of the HRU and a maximum infiltration rate. A depression storage can slow down surface runoff water before it reaches the HRU's outlet. Infiltrating water is distributed to two soil reservoirs with different porosities: the middle pore storage (MPS) and the large pore storage (LPS). Water can percolate into two groundwater compartments with different sizes and recession constants, characterized by quick and

slow reactions. Thus, four runoff contributions are calculated: surface runoff (RD1), interflow (RD2), quick base flow (RG1) and slow base flow (RG2). Once they have reached the stream, these runoff components are transferred from one river reach to the other using a simplified kinematic wave approach in the flow routing module. Other components provide functions for the regionalization of climate data and the calculation of potential evapotranspiration (PET).

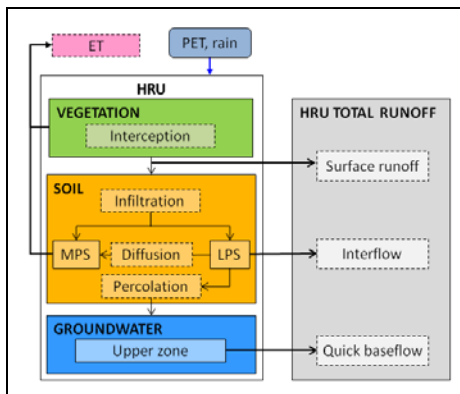

Figure 4: Physical processes and runoff contributions simulated for each HRU.

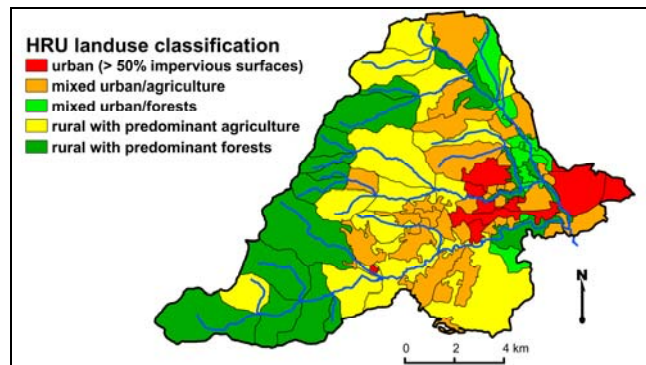

Figure 5: HRU delineation and land use classification derived from remote sensing images.

To take into account the local context and the available data, a simplified J2000 version with only one groundwater storage was already applied to the Yzeron catchment. The components for PET calculation were removed and a crop coefficient component was developed to use ET₀ time series, modulated according to the vegetation phenological development, as input data (Branger *et al.*, 2012, 2013). The development of J2000P is based on this version.

4.3 First steps towards the J2000P periurban model

4.3.1 Hourly simulations

The simplified version of J2000, applied without calibration, was already evaluated and validated at the daily time step, leading to a satisfactory simulation of the long-term variations of discharge, including the seasonal variations of base flow (Branger *et al.*, 2012, 2013). Subcatchments are used as HRUs (Figure 5) and the parameterization of the model is based on available information. For example, land use was re-classified into 5 classes (Figure 5) and average vegetation parameters (leaf area index, crop coefficient, root depth) were assigned for each class, according to FAO (1998) and Ecoclimap database (Masson *et al.*, 2003). The infiltration is characterized by impervious rates derived from land cover maps (Jacqueminet *et al.*, 2013, Branger *et al.*, 2013).

However, in urban areas where hydrological responses are quicker than in rural areas, a sub-daily time step can significantly improve the simulation of periurban hydrological processes. As J2000 had not been thoroughly tested at the hourly time step before, a few adaptations were necessary. We present here the first results of the comparison of hourly and daily simulations conducted with this version of J2000. The simulations, based on the 2008 land use, were conducted over a thirteen-year period (1997-2010), using the year 1997 as warming period. We used the same parameter values as for the daily simulation, except that we adapted the values of time step dependent parameters.

Table 1 : Set of performance indicators based on daily (D) and hourly (H) simulations over the period 1998-2010, at the catchment outlet (Taffignon). For the hourly simulation, the indicators were calculated based on the daily average of the hourly discharge.

	NS [-]	RMSE [m ³ /s]	Bias [%]	Abias [%]	Qmean [m ³ /s]	Qmax [m ³ /s]
D	0.46	1.06	38	74	0.86	45.2
H	0.17	1.31	68	98	1.04	60.4

In order to compare the simulated and observed discharges, a set of performance indicators was calculated for the time period 1998-2010: the classical Nash-Sutcliffe (NS) efficiency to characterize high flows, the root mean square error (RMSE) to quantify the mean error in discharge and the bias and absolute bias (Abias) to evaluate the mass balance (Table 1). For the hourly simulation, the NS is calculated based on the daily average of hourly discharges. But, even in that case, the NS are less good for the hourly simulations which might be caused by a higher overestimation and quicker

dynamics of the hourly discharge. In fact, the results of maximum and mean discharges and the analysis of the discharge evolution reflect quicker and higher reaction of the hourly discharges in response to a more noisy rain signal (see an example on Figure 6). Figure 7 and bias results show that the model tends to overestimate the discharge at the outlet and that the overestimation is higher for the hourly simulation. This can be explained by the general water balance with a higher interannual mean soil saturation (0.39) and actual evapotranspiration (AET) response (73% in percentage of rain) for the daily simulation (Figure 8). For the hourly simulations, the AET (68 % in percentage of rain) seems to be limited by a smaller soil water availability (mean soil saturation equals to 0.33). The analysis of MPS and LPS behaviours shows a quicker decrease of the amount of stored water simulated by the hourly model before the dry season. This is reflected in the relative contributions of the discharge components, also influenced by the time step change.

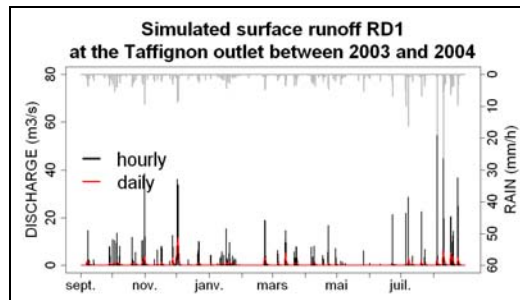

Figure 6: Hourly (black) and daily (red) simulated surface runoff over one hydrological year. The hourly rain is drawn in grey

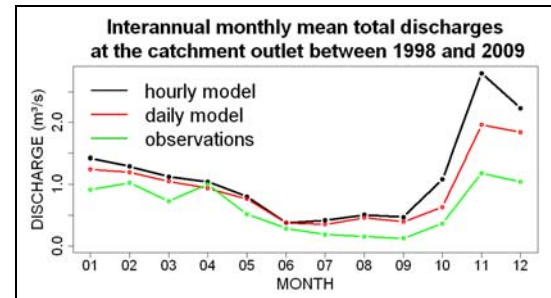

Figure 7: Comparison of interannual monthly mean hourly and daily simulated discharges and observed discharges at the outlet of the catchment.

Concerning the groundwater, the hourly model simulates higher base flow (Figure 9) which is mainly governed by water availability. As there is less AET generated by the hourly model, higher base flow is produced. However, the base flow contribution also involves time-dependent parameters whose sensitivity must be analyzed more in depth (e.g.; a percolation rate).

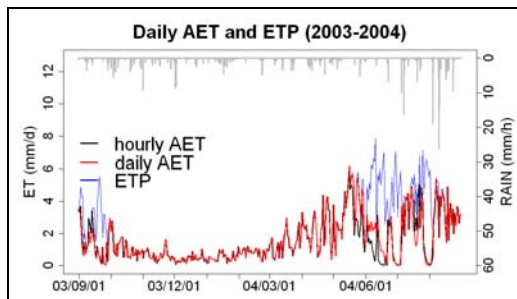

Figure 8: Comparison between daily and hourly evapotranspiration (ET) results.

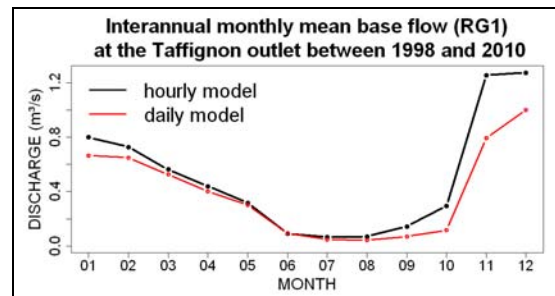

Figure 9: Comparison of interannual monthly mean hourly and daily base flow.

4.3.2 Implementation of a sewer network

In order to better take into account rainwater management, an explicit representation of sewer networks is implemented in the J2000P model. It receives urban rainwater coming from impervious surfaces connected to a sewer system and delivers this water to a separate outlet or directly to the river in case of sewer overflow device (SOD) outflows. Technically, a new network made of sewer reaches is added (similarly to the river network already implemented) and a SOD module is developed. Then, as one HRU can have rural and urban fractions which can be drained differently, the model is modified to offer the possibility to assign several outlets to one HRU. In particular, different proportions of the outflows of each HRU can go to the sewer network, a neighbouring HRU and the river network.

As shown in Figure 10, the spatial routing scheme of J2000P is modified as compared to the previous version of J2000. Each sewer reach connected to the river by a SOD is characterized by a threshold and pipe dimensions. If the water height inside a sewer reach connected to a SOD is above its threshold, the excess water goes into the river. A combination of weir and orifice equations is chosen to calculate the discharge (Figure 11). In case of a rainwater system, there is a direct connection of the outlet of the sewer system to the river.

Up to now, we first validated a test model with two parallel rivers (and thus two outlets) that were fed upstream using a test data set. The SOD module was also developed and validated with another test model made of two parallel reaches and one SOD, also fed using a test signal.

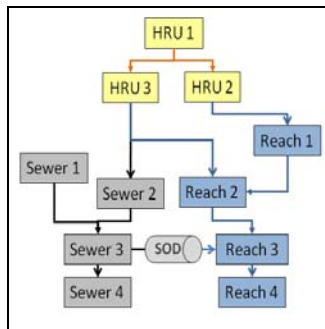

Figure 10 : Spatial routing scheme of J2000P.

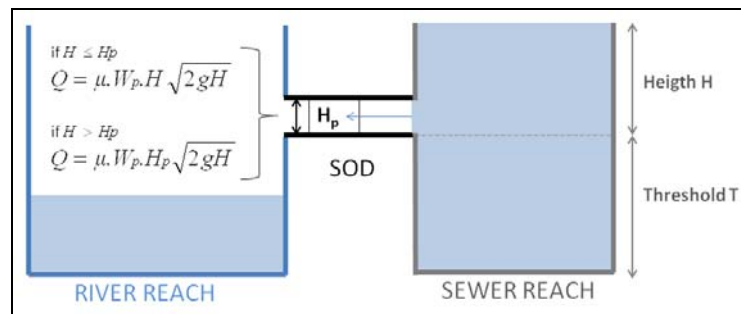

Figure 11 : Outline of the functioning of a SOD. The SOD is parameterized by its height H_p and width W_p .

5 CONCLUSION

The methodology described in this paper consists of a multiscale approach which focuses on the understanding and the formalizing of dominant periurban hydrological processes from small scales (few ha to few km²) to larger scales (~ 150 km²). The objectives are to 1) simulate both urban and rural hydrological processes and 2) test the effects of different hydrological scenarios on the long-term hydrology of medium-sized periurban catchments. For the application of the method, we chose the medium-scaled catchment of Yzeron as it is subjected to a fast progression of urbanization since the eighties and has been monitored for a long time period. For the modelling, J2000 already appeared to be an appropriate simulation tool for the water balance study of the Yzeron catchment without any calibration. As it was not designed especially for periurban areas, its structure and parameters need to be adapted. For this purpose, two first adaptations of J2000 were proposed here: time step decrease and implementation of a sewer network, leading to the development of the J2000P periurban version of J2000. The first results of the hourly simulation are presented but a further sensitivity analysis has still to be done. Concerning the implementation of the sewer network, it was validated on a test case and the next step consists in testing it on the whole catchment, thanks to the available map of the sewer system.

Ongoing work will focus on a better representation of urban hydrological processes. A major step is the HRU's delineation which takes into account the different hydrological objects in periurban areas and their optional connection to the rainwater system. This delineation will hopefully improve the modelling of the water routing from upstream to downstream with the modifications generated by the artificial channels. More studies have also to be conducted on the routing inside the HRUs: the rural and the urban parts of the HRUs do not route the water in the same time and the routing depends on the distance of the different objects from the outlet of the HRU. Different methods can be tested to simulate the intra-HRU routing: sub-grid variability or average calculation. Further effort needs to be spent on the calculation of runoff coefficients. Once the model performance is validated, it will allow a better representation of historic and actual conditions. For water managers, it can be an interesting tool for testing projections of future urban development, not only for extreme conditions but also for long term and continuous periods.

ACKNOWLEDGEMENTS

Some of the data used in this study are taken from the ANR VMCS AVuPUR project (contract ANR-07-VULN-01) and OTHU. The study is conducted under the EC2CO BVPU/ROSENHY project.

LIST OF REFERENCES

- Beighley, R. E. and Moglen, G. E. (2002). *Trend assessment in rainfall-runoff behavior in urbanizing watersheds*. Journal of Hydrologic Engineering, 7(1):27–34.
- Branger, F. (2007). *Utilisation d'une plate-forme de modélisation environnementale pour représenter le rôle d'aménagements hydro-agricoles sur les flux d'eau et de pesticides. Application au bassin versant de la Fontaine du Theil (Ille-et-Vilaine)*. Université Joseph Fourier, Grenoble I, Grenoble, France.
- Branger F., Kermadi S., Krause P., Labbas, M., Jacqueminet, C., Michel, K., Braud, I. and Kralisch, S. (2012), *Investigating the impact of two decades of urbanization on the water balance of the Yzeron peri-urban*

- catchment, France*. Proceedings of the iEMSs 2012 International Congress, Leipzig, Germany.
- Branger, F., Kermadi, S., Jacqueminet, C., Michel, K., Labbas, M., Krause, P., Kralisch, S., Braud, I., (2013). *Assessment of the influence of land use data on the hydrology of a periurban catchment using a distributed modelling approach*, Journal of Hydrology, in revision.
- Braud, I. et al. (2010). *The AVuPUR project (Assessing the Vulnerability of Peri-Urbans Rivers) : experimental set up, modelling strategy and first results*, Proceedings of the 7th Novatech 2010 Conference, June 28-July 1 2010, Lyon, France, 10pp. http://hal.archives-ouvertes.fr/hal-00527564_v1/
- Braud, I., Breil, P., Thollet, F., Lagouy, M., Branger, F., Jacqueminet, C., Kermadi, S., Michel, K., (2013). *Evidence of the impact of urbanization on the hydrological regime of a medium-sized periurban catchment in France*, Journal of Hydrology, 485, 5-23.
- Burns, D., Vitvar, T., McDonnell, J., Hassett, J., Duncan, J. and Kendall, C. (2005). *Effects of suburban development on runoff generation in the Croton River basin, New York, USA*. J. of H., 311(1-4):266–281.
- Cottet, M. (2005). *Evolution de l'occupation du sol dans le bassin versant de l'Yzeron au cours du XXème siècle: premiers éléments pour un diagnostic hydrologique*. Université Jean Moulin, Lyon III, Lyon.
- Dodane, C., Joliveau, T., Honegger, A. and Molines, N. (2010). *Simuler les changements d'occupation du sol à l'horizon 2030*. CNRS UMR EVS, Atelier Yzeron.
- FAO (1998). *Crop Evaporation - Guidelines for computing crop water requirements*. Irrigation and Drainage paper n°56, FAO, Rome.
- Flügel, W. . (1995). *Delineating hydrological response units by geographical information system analyses for regional hydrological modelling using PRMS/MMS in the drainage basin of the river Brol, Germany*. Hydrological Processes, 9(3-4):423–436.
- Gnouma, R. (2006). *Aide à la calibration d'un modèle hydrologique distribué au moyen d'une analyse des processus hydrologiques: application au bassin versant de l'Yzeron*. INSA, Lyon, France, 448 pp.
- Grand Lyon. (2006). *Aménagement et eaux pluviales sur le territoire du Grand Lyon*, Guide pratique.
- Jacqueminet C., Kermadi S., Michel K., Béal D., Branger F., Jankowsky S., Braud I., (2013). *Land cover mapping using aerial and VHR satellite images for distributed hydrological modelling of periurban catchments: application to the Yzeron catchment (Lyon, France)*, Journal of Hydrology, 485, 68-83.
- Jankowsky, S. (2011). *Understanding and modelling of hydrological processes in small peri-urban catchments using an object-oriented and modular distributed approach. Application to the Chaudanne and Mercier subcatchments, France*. UJF, Grenoble, France, 321 pp. <http://tel.archives-ouvertes.fr/tel-00721988>
- Jankowsky, S., Branger, F., Braud, I., Gironás, J. and Rodriguez, F. (2012). *Comparison of catchment and network delineation approaches in complex suburban environments: application to the Chaudanne catchment, France*. Hydrol. Process. doi: 10.1002/hyp.9506 .
- Kermadi, S., Braud, I., Jacqueminet, C., Branger, F., Renard, F., Michel, K., (2013). *Quels liens entre climatologie, occupation des sols et inondations dans le bassin versant de l'Yzeron (ouest Lyonnais) ? Apport de l'analyse conjointe de données hydroclimatiques et d'images satellitaires très haute résolution*, Climatologie, in press.
- Kralisch, S., Krause, P., Fink, M., Fischer, C. and Flügel, W.-A (2007). *Component based environmental modelling using the JAMS framework*, in L. Oxley & D. Kulasiri, Eds., MODSIM 2007, pp. 812-818.
- Krause, P., Båse, F., Bende-Michl, U., Fink, M., Flügel, W. and Pfenning, B.(2006) *Multiscale investigations in a mesoscale catchment - hydrological modelling in the Gera catchment*, Advances in Geosciences, 9, 53-61.
- Leopold, L. (1968). *Hydrology for urban landplanning—A guidebook on the hydrologic effects of urban land use*. U.S. Geological Survey Circular 554.
- Masson, V., Champeaux, J.L., Chauvin, F., Meriguet, C., Lacaze, R., (2003). *A global database of land surface parameters at 1-km resolution in meteorological and climate models*. J. Climate, 16(9), 1261-1282.
- O'Loughlin, G., Huber, W. and Chocat, B. (1996). *Rainfall-runoff processes and modelling*. Journal of Hydraulic Research, 34(6):733–751.
- OTHU (2012). <http://www.graie.org/othu/>. Consulted on 2012/10/23.
- Radojevic, B., Breil, P. and Chocat, B. (2010). *Assessing impact of global change on flood regimes*. International Journal of Climate Change Strategies and Management, 2(2), 167-179.
- Rodriguez, F., Andrieu, H. and Morena, F. (2008). *A distributed hydrological model for urbanized areas - model development and application to case studies*. J Hydrol, 351(3-4):268–287.
- SIRA (2012). Sol Info Rhône-Alpes, - <http://www.rhone-alpes.chambagri.fr/sira/>. Consulted on 2010/09/16.
- Vidal, J.P., Martin, E., Franchisteguy, L., Baillon, M. and Soubeyroux, J.M. (2010). *A 50-year high-resolution atmospheric reanalysis over France with the SAFRAN system*. Int J Climatol, 30(11), 1627-1644.
- Walsh, C. J., Fletcher, T. D. and Ladson, A. R. (2005). *Stream restoration in urban catchments through redesigning stormwater systems : looking to the catchment to save the stream*. Journal of the North American Benthological Society, 24(3):690–705.
- Willems, P. (2009). *A time series tool to support the multi-criteria performance evaluation of rainfall runoff models*. Environmental Modelling and Software, 24(3):311–321.