



7th International Workshop on Numerical Modelling of High Temperature Superconductors
22nd – 23rd June 2021, Virtual (Nancy, France)

Numerical modelling of the ferromagnetic- superconductor interaction in 3D geometry using A–formulation

M. Solovyov¹, F. Gömöry¹

¹ Institute of Electrical Engineering
Slovak Academy of Sciences
Bratislava, Slovakia

Contact: mykola.solovyov@savba.sk

The Comsol Multiphysics 3D model of superconducting cup magnetization in A-formulation is available on: http://www.htsmodelling.com/?page_id=748#cup

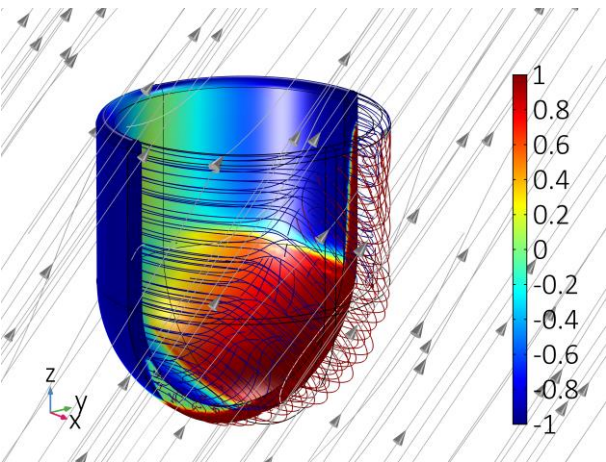

$t = T/4$

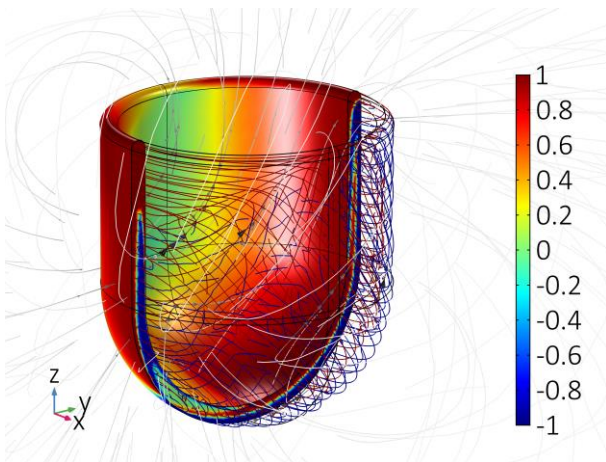

$t = T/2$

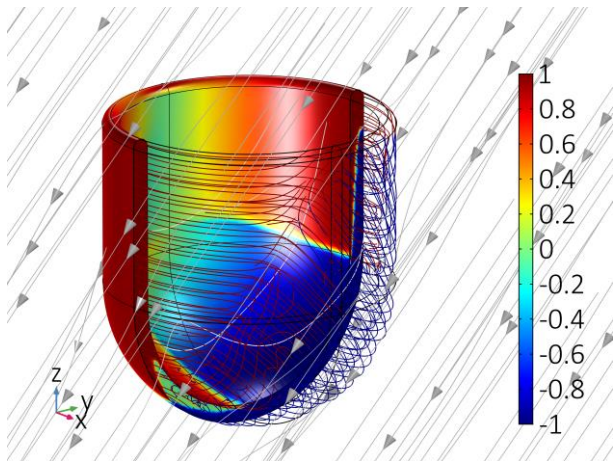

$t = 3T/4$

This approach works perfectly in modelling the Coated Conductors also:

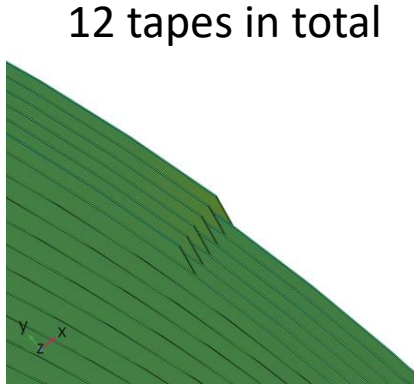
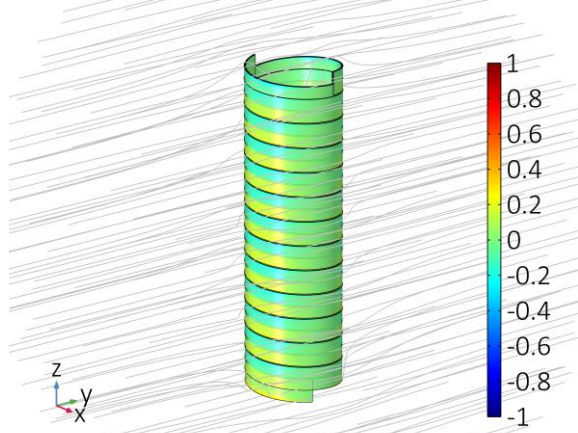

12 tapes in total

Numerical modelling, A-formulation ¹

The reduced form of Maxwell eq. for electric field* is used:

$$\vec{E} = -\frac{\partial \vec{A}}{\partial t} \quad (1)$$

* The default equation for Time Dependent solver in the Predefined Physics Interface "Magnetic Fields" included in AC/DC module.

2D: $J_z = J_c \tanh\left(\frac{E_z - V}{E_c}\right) \quad (2)$

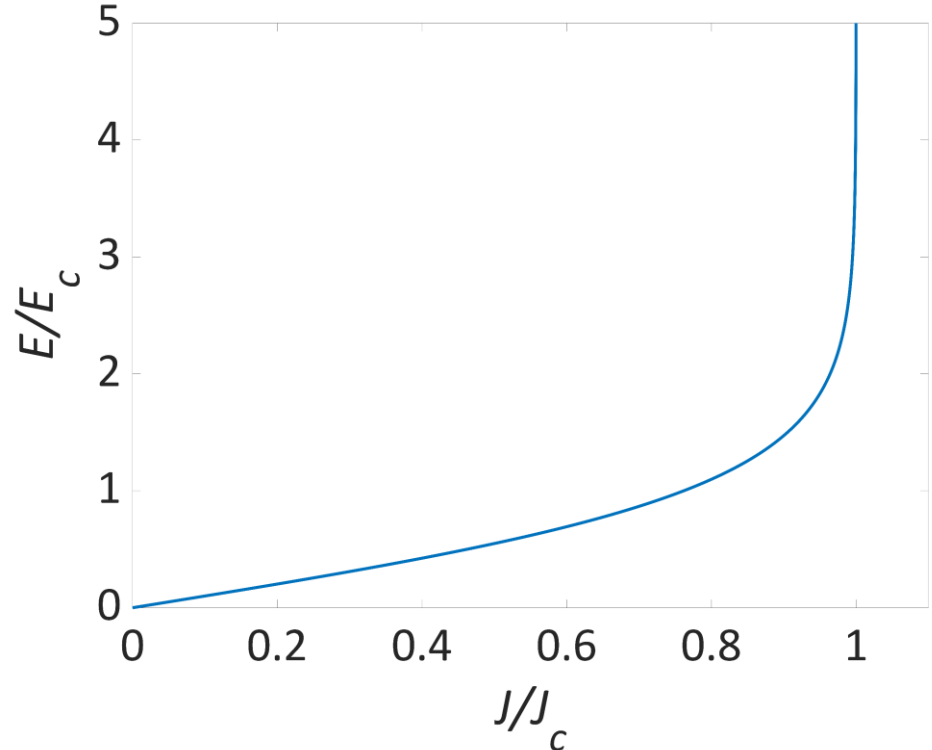

3D: $\vec{J} = \frac{J_c}{|E|} \left(|E_x| \tanh\left(\frac{E_x}{E_c}\right) \hat{i} + |E_y| \tanh\left(\frac{E_y}{E_c}\right) \hat{j} + |E_z| \tanh\left(\frac{E_z}{E_c}\right) \hat{k} \right) \quad (3)$

J_c - critical current density

E_c - critical electric field equivalent

¹ M Solovyov, F Gömöry, Supercond. Science and Technology 32 11 115001 (2019).

The A-formulation approach works also for imperfect mesh, like this

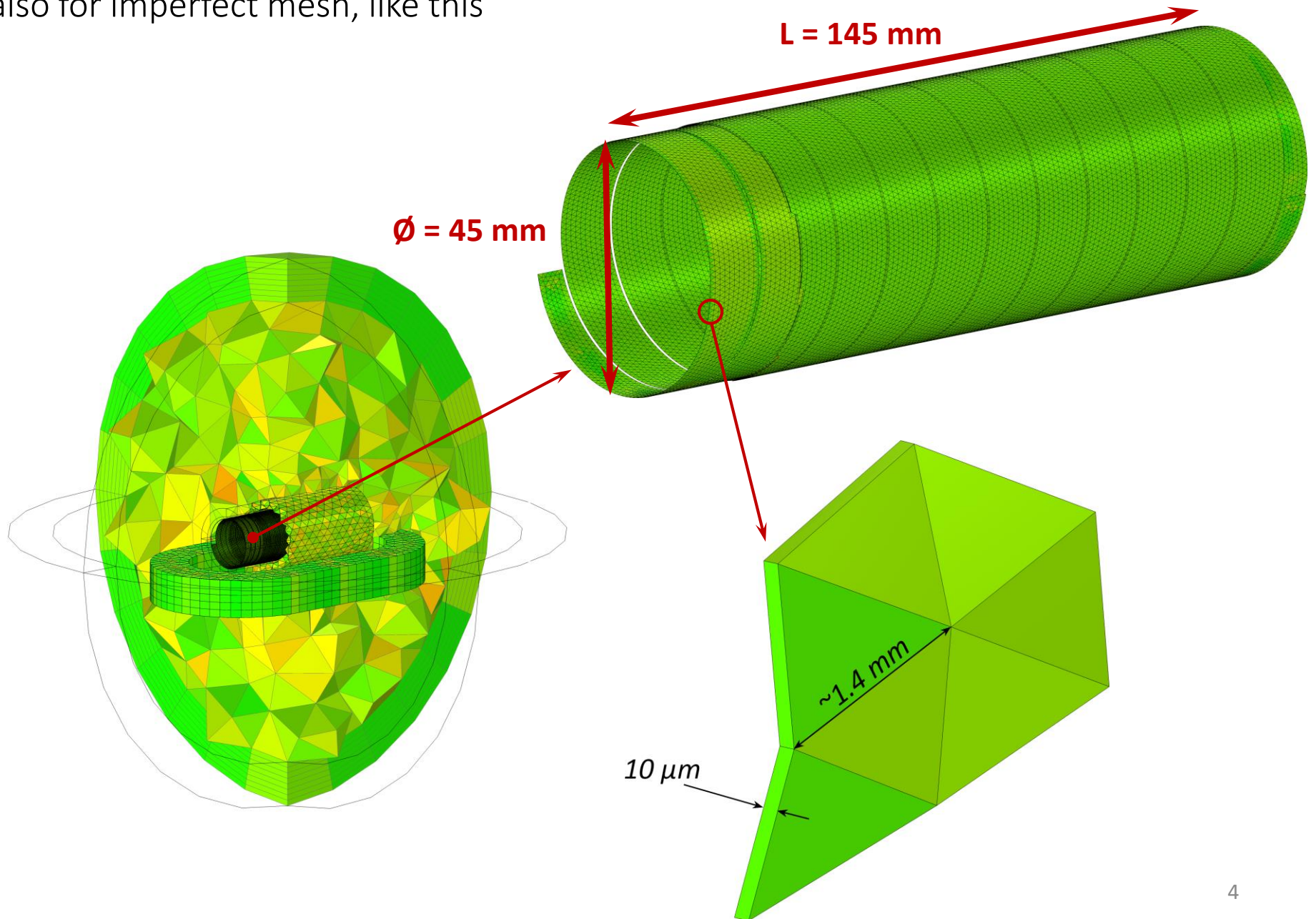

Mesh quality statistics

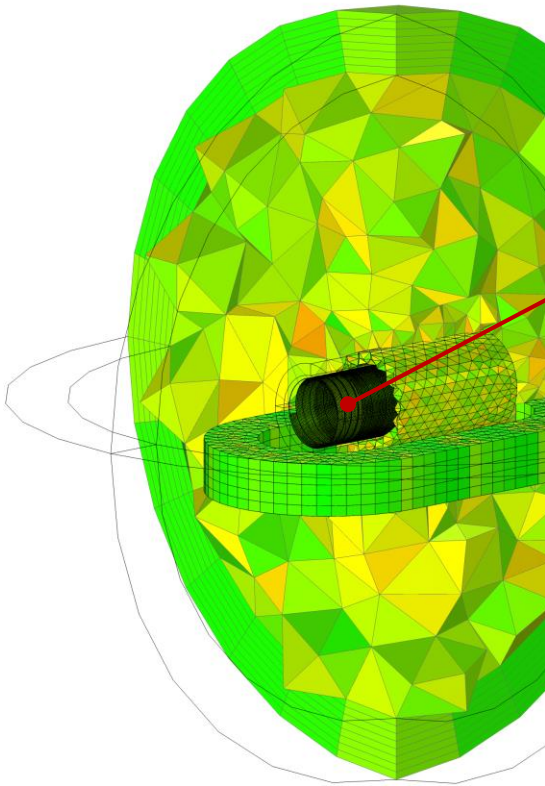

Statistics	
Complete mesh	
Mesh vertices:	307075
Element type:	All elements
Tetrahedra:	1172867
Pyramids:	21212
Prisms:	212692
Triangles:	417012
Quads:	21904
Edge elements:	42148
Vertex elements:	138
— Domain element statistics —	
Number of elements:	1406771
Minimum element quality:	1.105E-5
Average element quality:	0.3363
Element volume ratio:	6.814E-12
Mesh volume:	0.06425 m ³

Element Quality Histogram

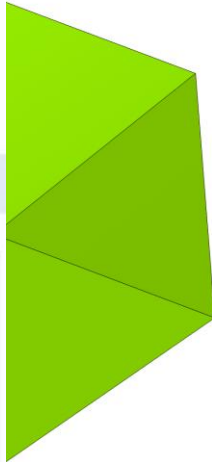
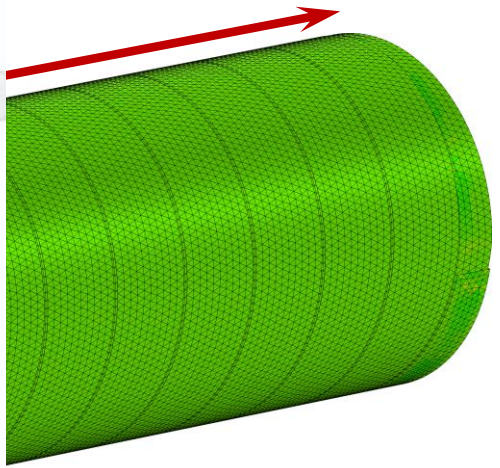

Superconducting shield

SF12050-AP tape from Furukawa (SuperPower) company.
Declared minimal I_c is 387 A.



a)

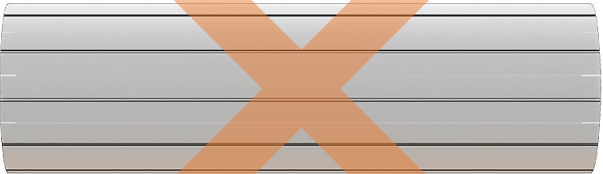

Straight tapes
could be modelled in 2D geometry

b)



Helicoidally wound tapes
3D model required

The numerical model of the wound tapes show good agreement with the experiment

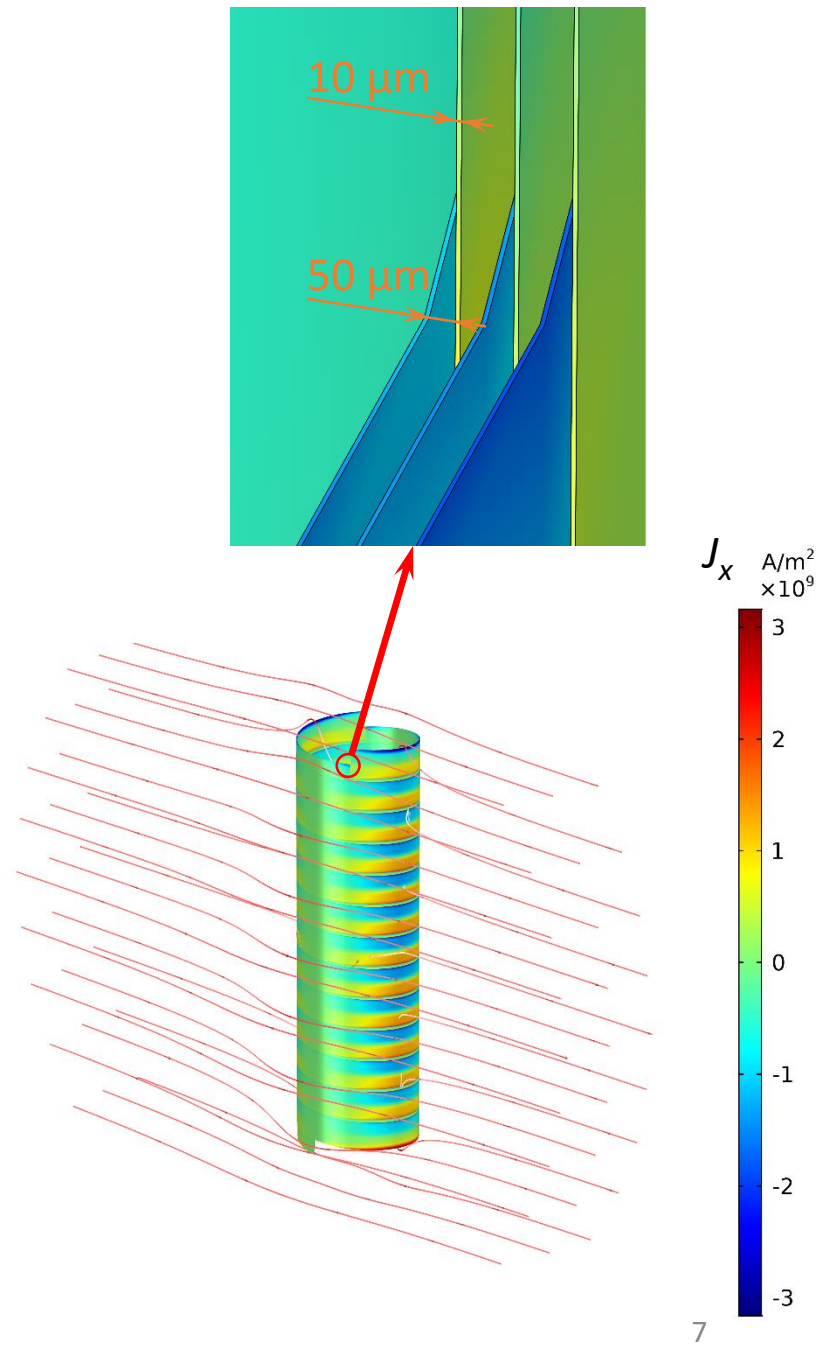
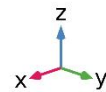
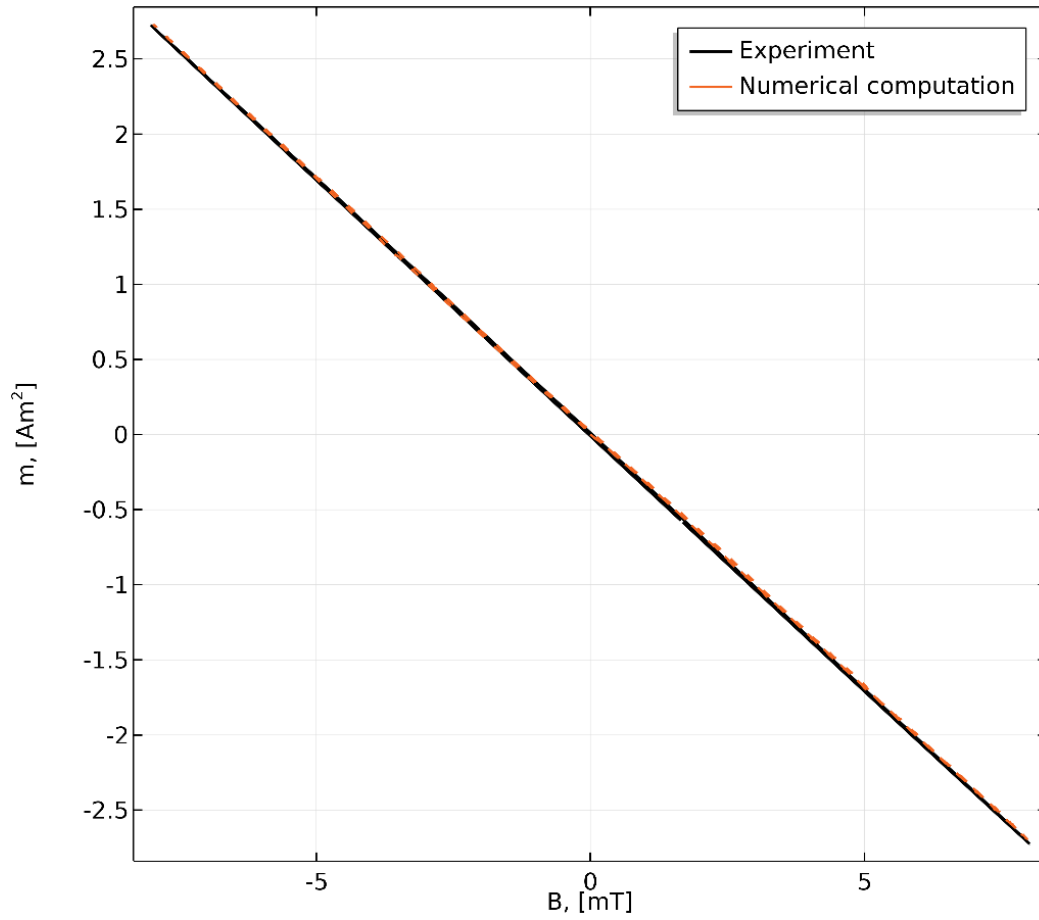

The magnetic cloak versus the conventional superconducting shield in a uniform magnetic field

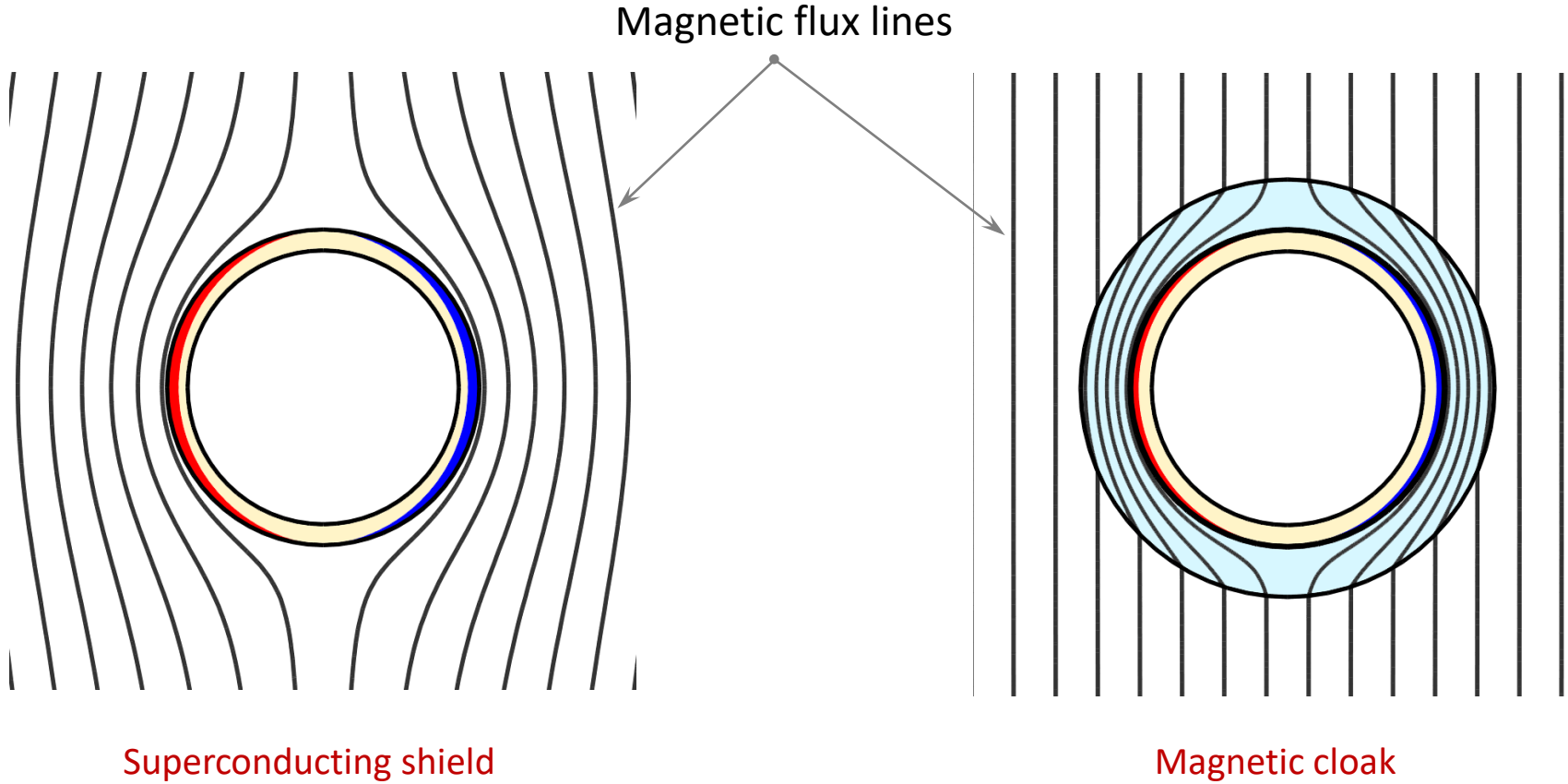

Physical background ^{2, 3}

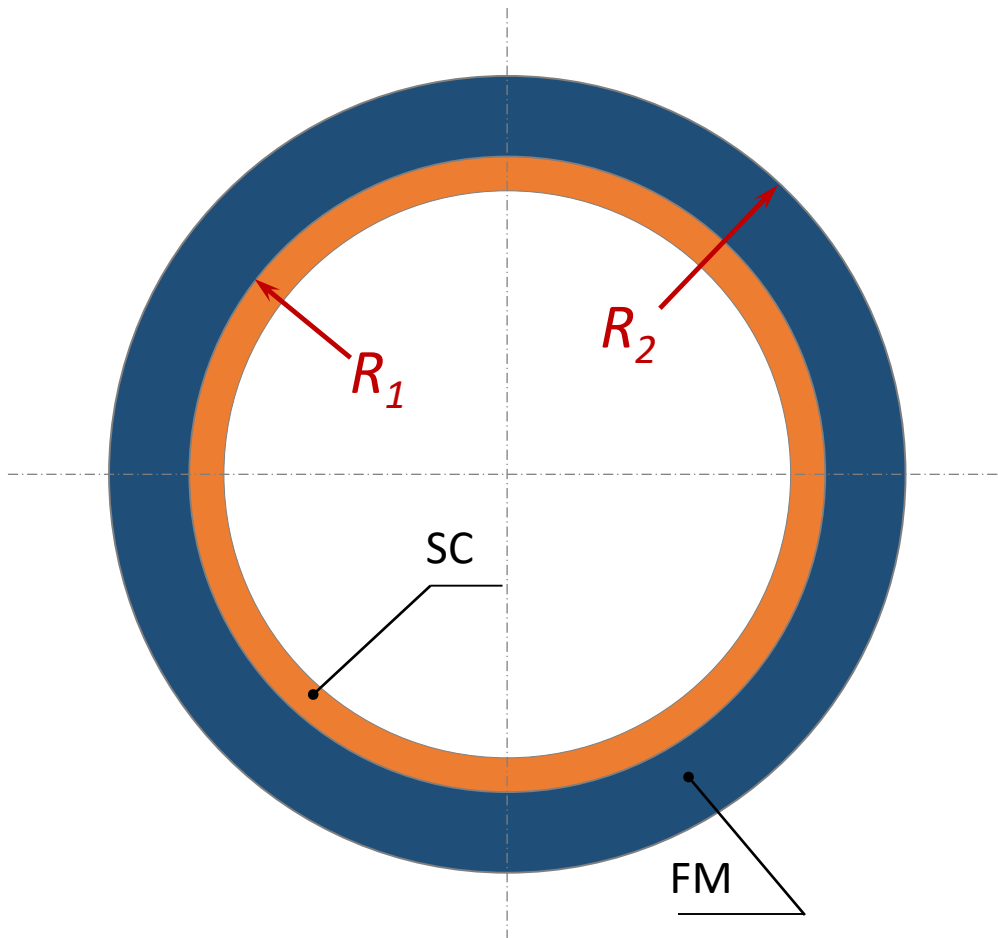

$$\mu_r = \frac{R_1^2 + R_2^2}{R_2^2 - R_1^2} \quad (4)$$

μ_r - relative permeability of FM material

R_1 and R_2 are inner and outer radiuses of the FM shell

² A. Sanchez, C. Navau, J. Prat-Camps, D.-X. Chen, New J. Phys. 13, 093034 (2011).

³ F Gömör, M Solovyov, J Šouc, C Navau, J Camps, A.Sanchez, Science 335 1466 (2012).

Ferromagnetic shell

$\text{Li}_{0.575}\text{Zn}_{0.4}\text{Ti}_{0.55}\text{Fe}_{1.475}\text{O}_4$ ferrite powder ⁴
 with grain size below 80 μm , mixed with
 the epoxy resin (31.2 vol. %)

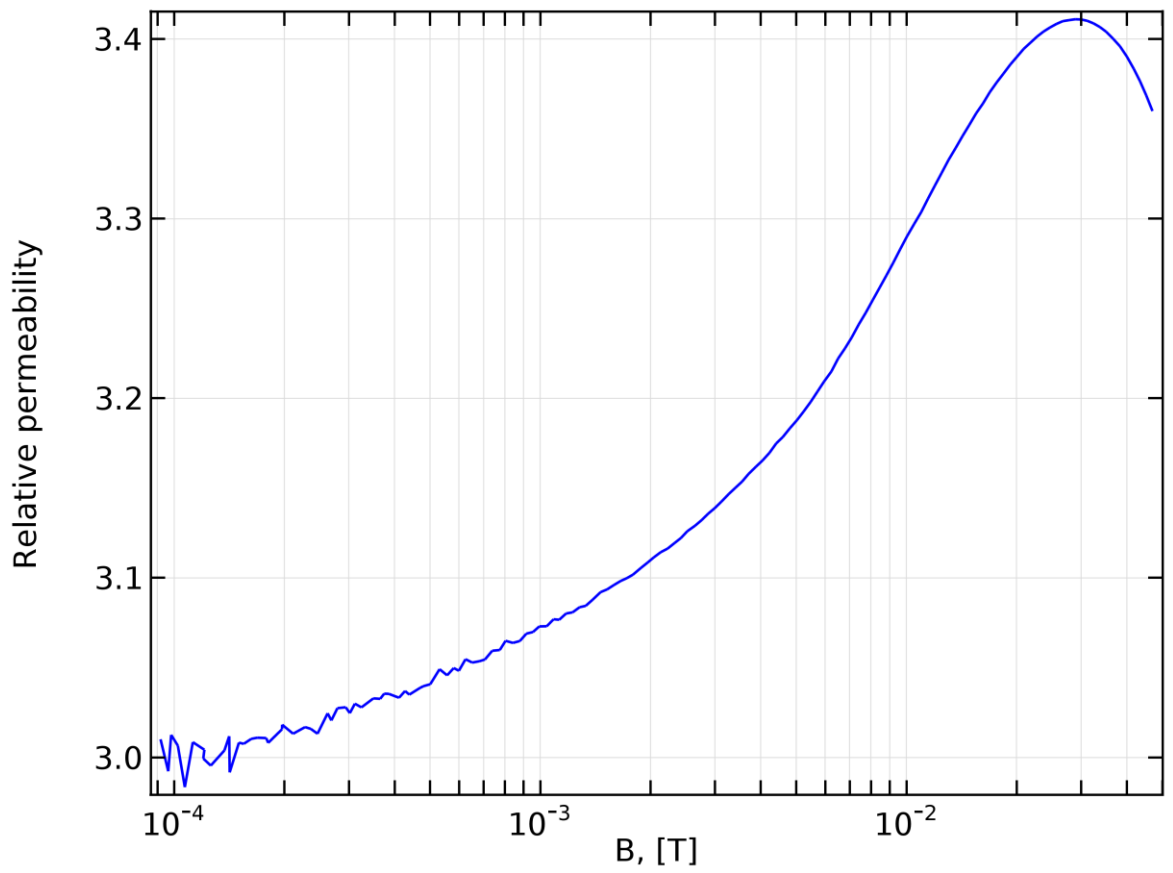

$R_{in} = 25 \text{ mm}$
 $R_{out} = 32.75 \text{ mm}$
 length = 150 mm



**Optimal $\mu_r = 3.8$ from
 2D linear formula (4)**



- Measurement error
- Non-homogenous distribution of the ferrite powder
- Influence of field-dependent properties of the materials

⁴ R Dosoudil, M Ušáková, A Grusková, J Sláma, IEEE Trans. On Magn., 50 4 (2014)

Jiles-Atherton model

Parameter	Saturation magnetization, M_s [A/m]	Domain wall density, a [A/m]	Pinning loss, k_p [A/m]	Magnetization reversibility, c_r	Inter-domain coupling, α
Value	$4 \cdot 10^5$	7 200	$1.56 \cdot 10^5$	0.15	0.0001

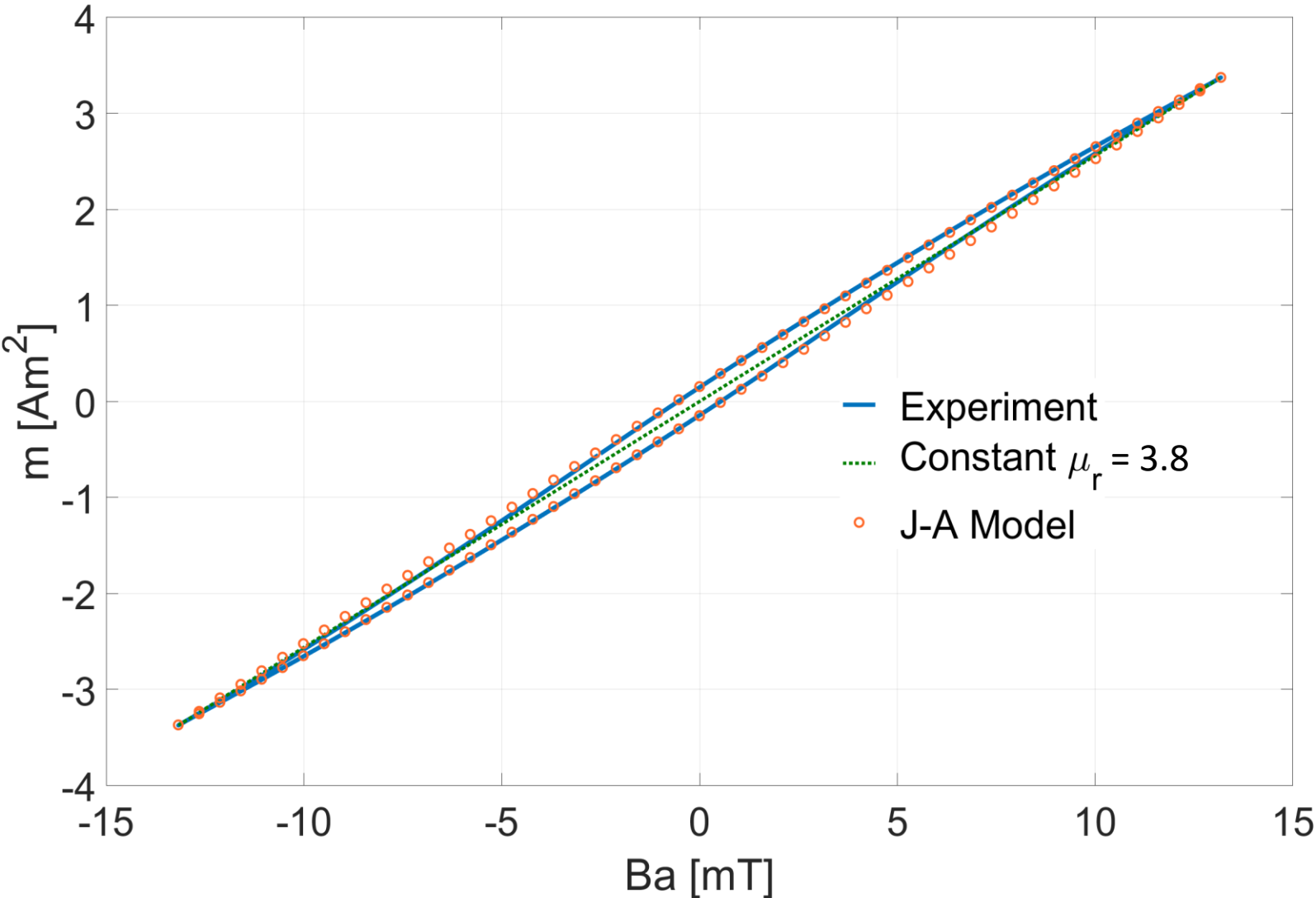

Magnetization experiment

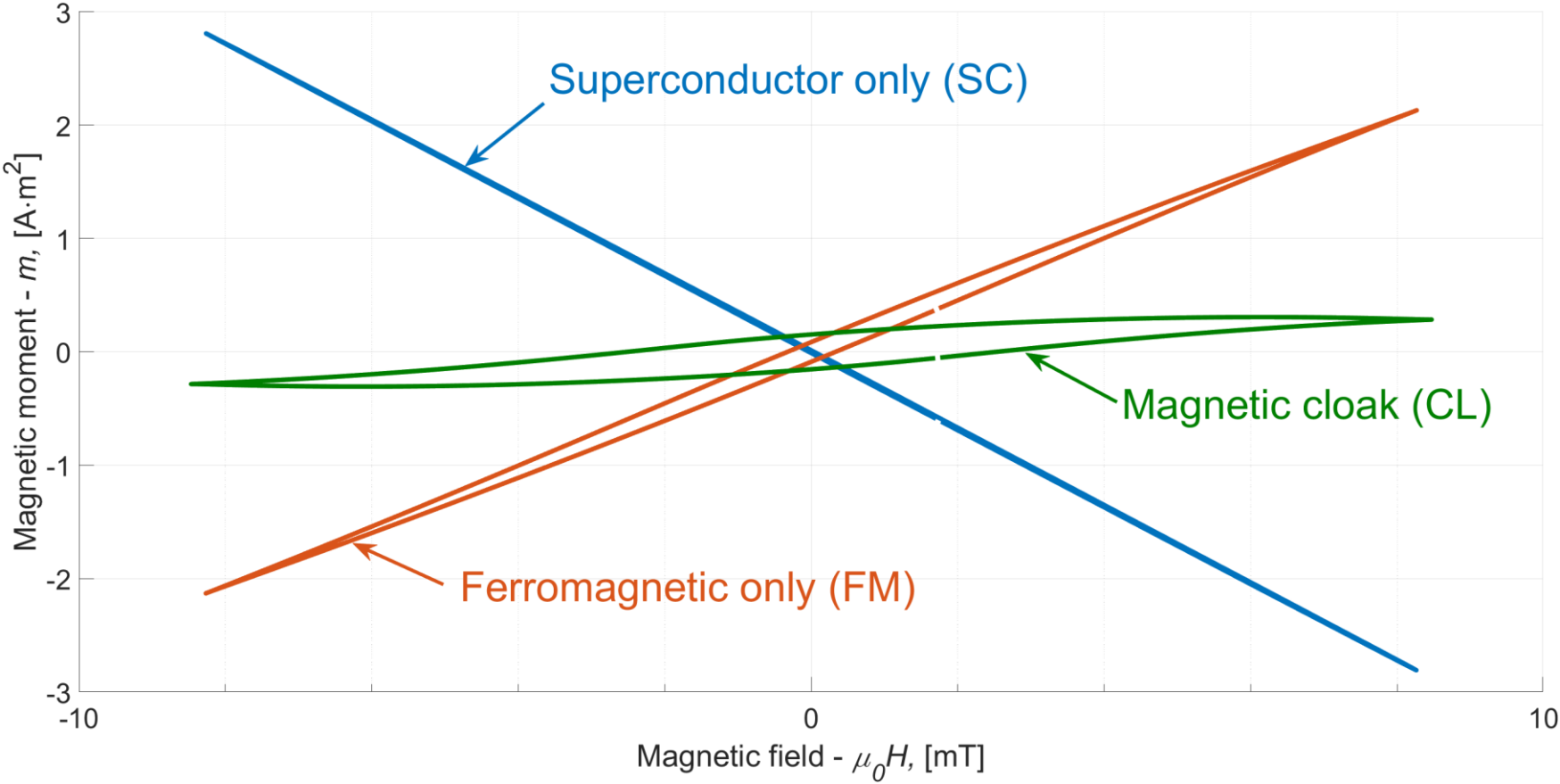

Magnetization loops of the magnetic cloak⁵

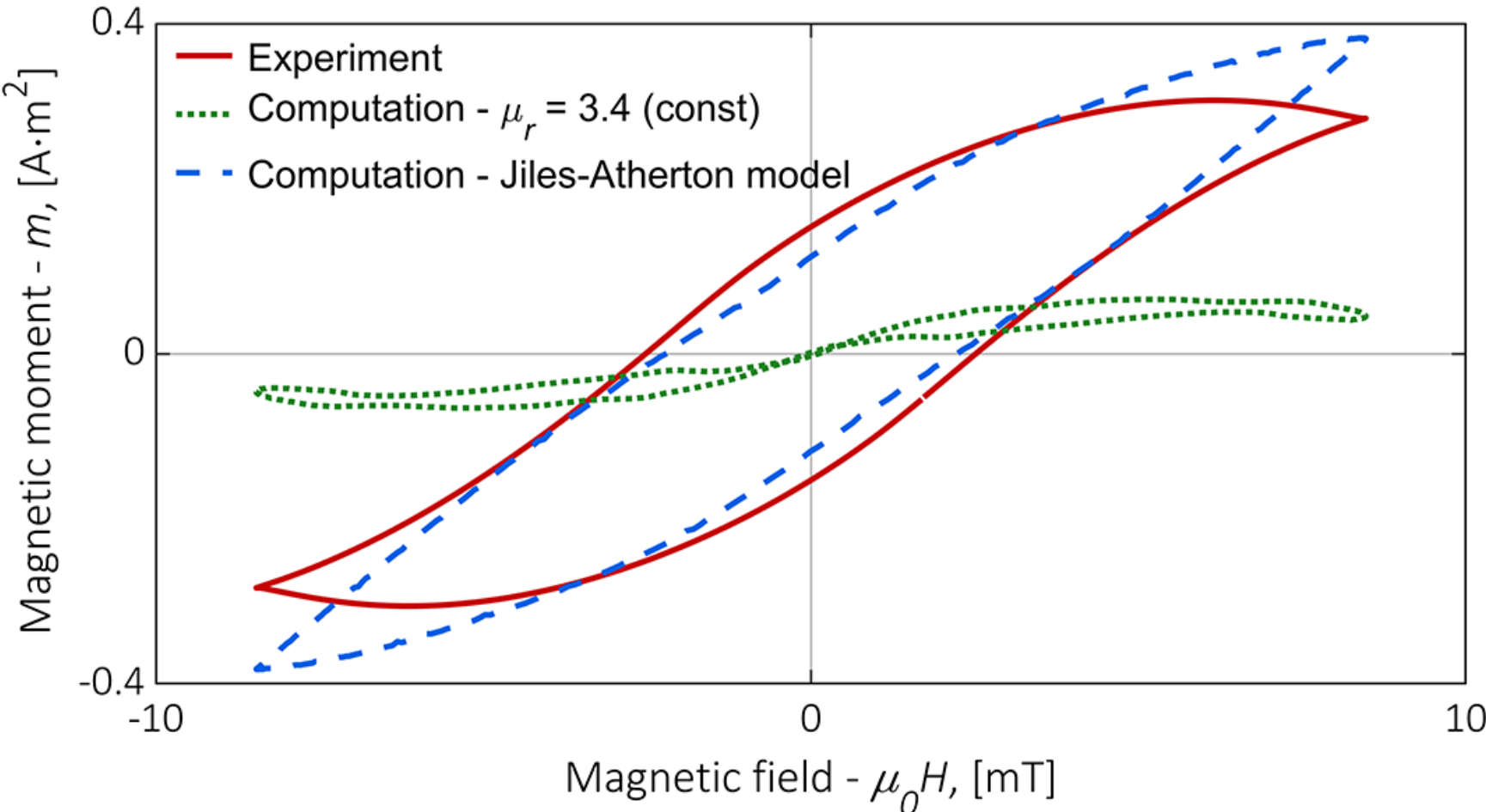

⁵ M. Solovyov, J. Šouc, M. Kucharovič, F. Gömory, IEEE Trans. on Appl. Supercond., 31 5 (2021)

Magnetization loops of the magnetic cloak (3 layers in superconducting part)⁶

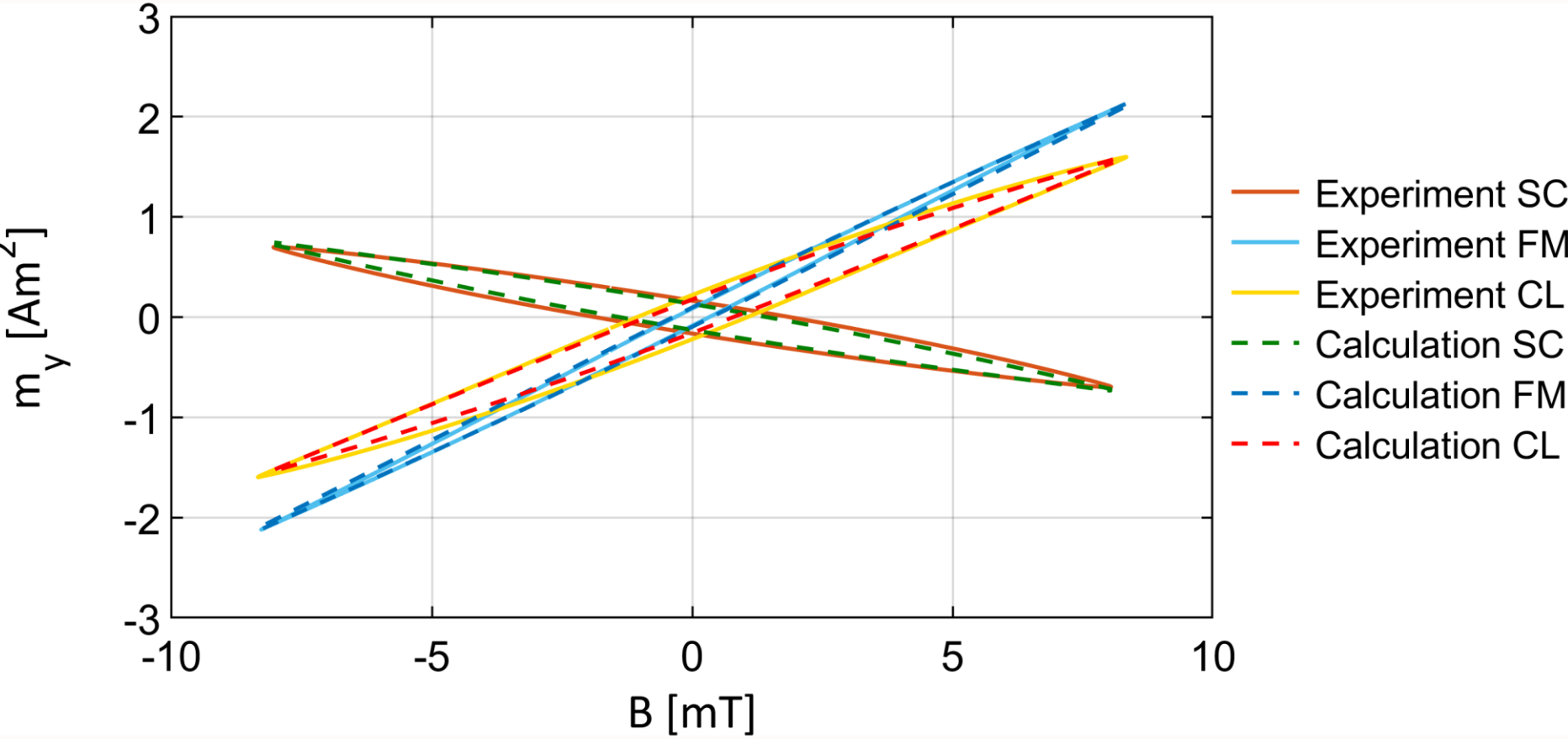

⁶ Poster presentation on ASC 2018 (2LPo2M-08)

Force interaction experimental setup

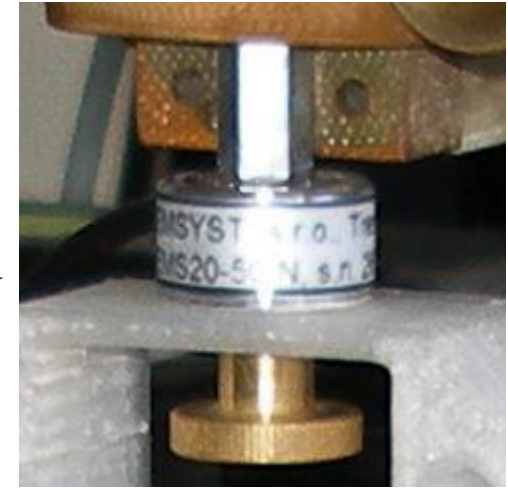
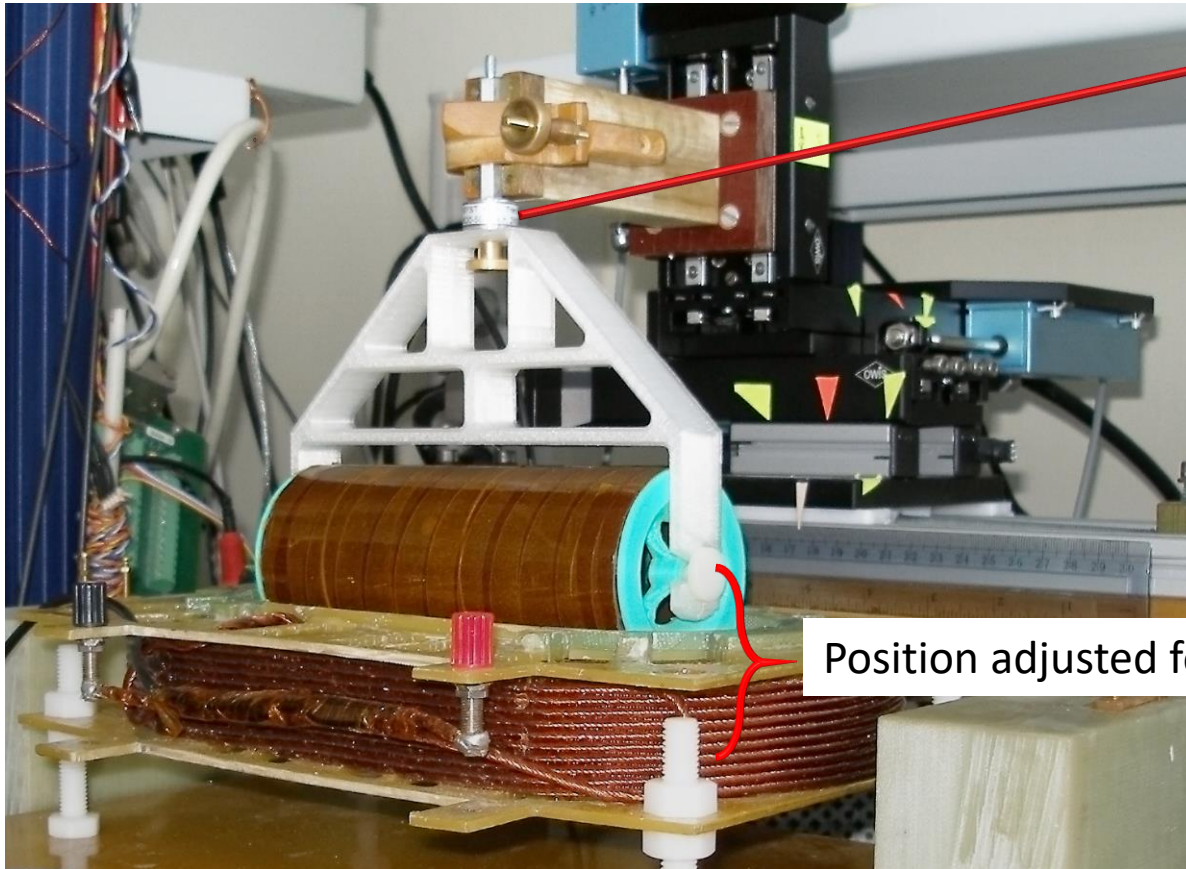

Force meter
EMSYST EMS20-5

Position adjusted for maximum force $F \sim B \frac{\partial B}{\partial z}$

Force interaction experiment

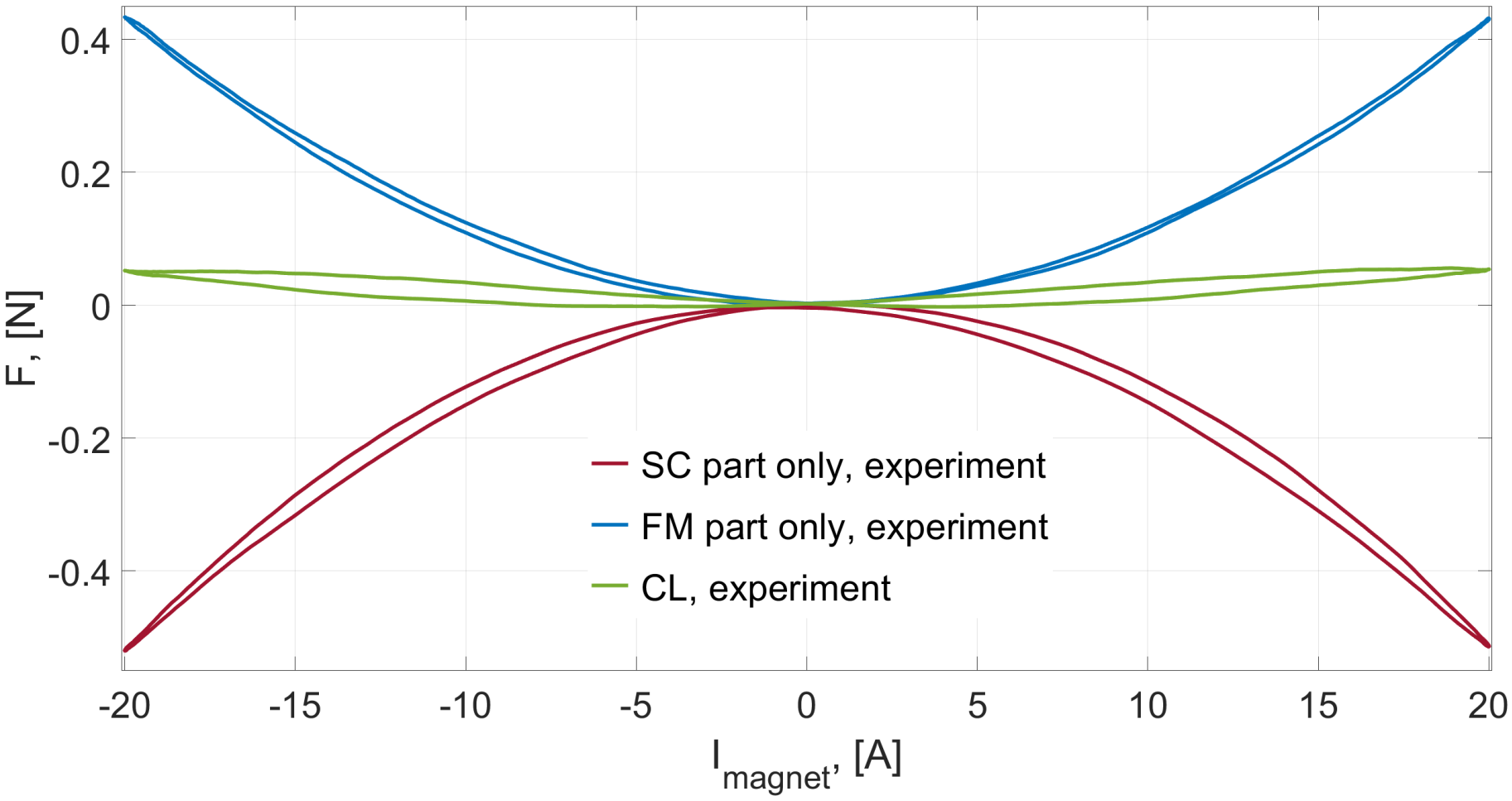

Magnetic cloak

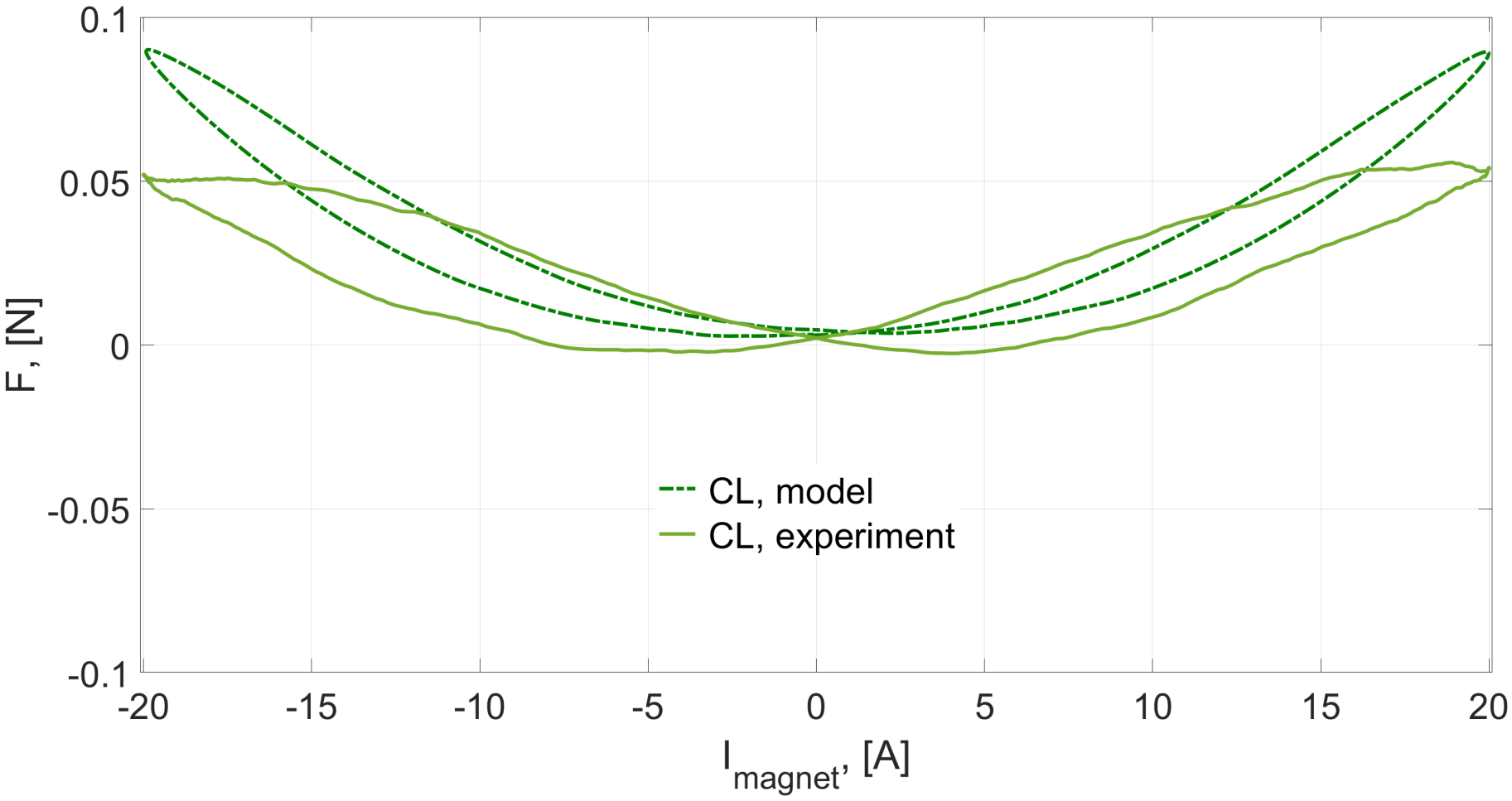

Superconducting part

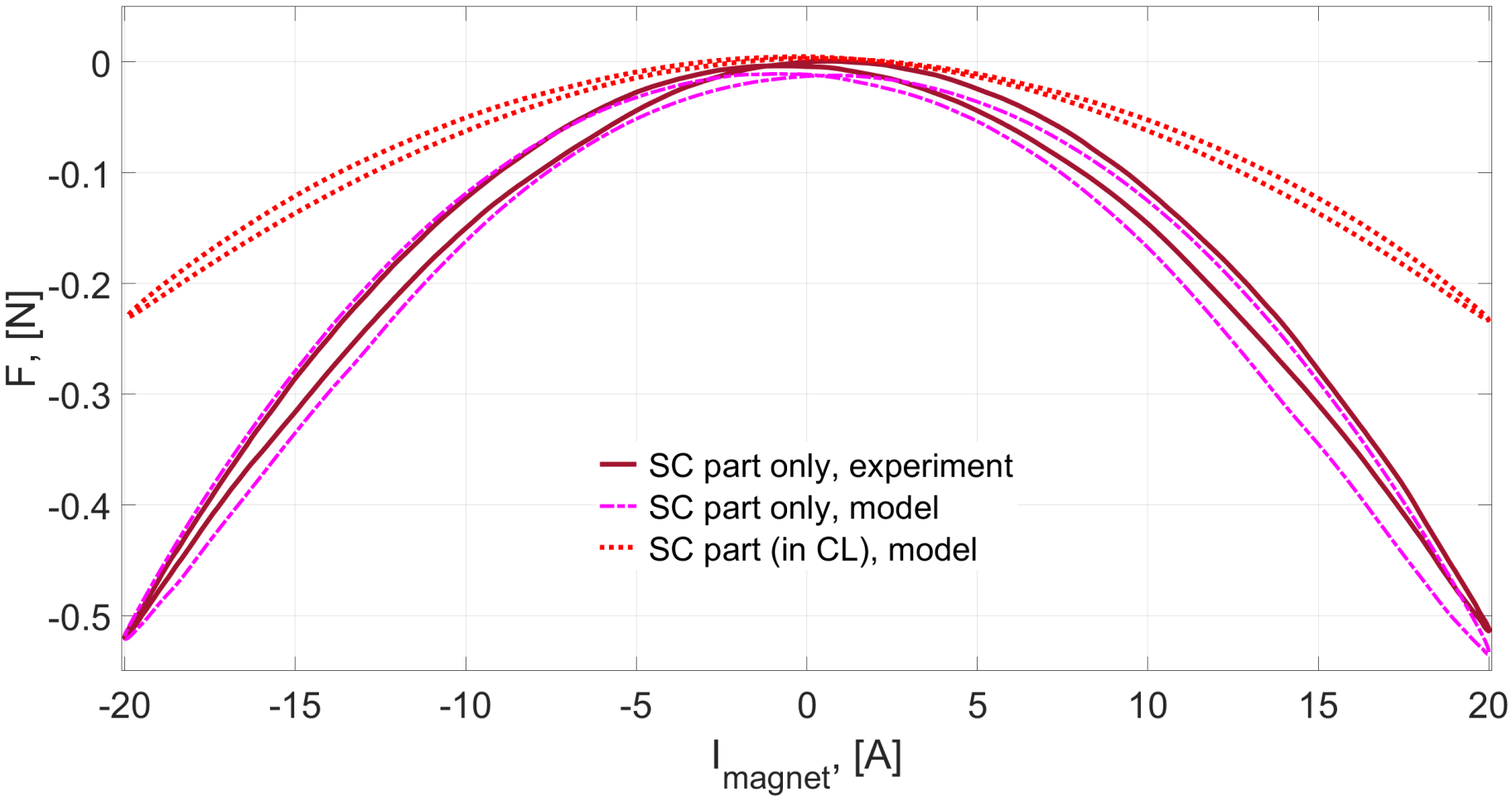

Ferromagnetic shell

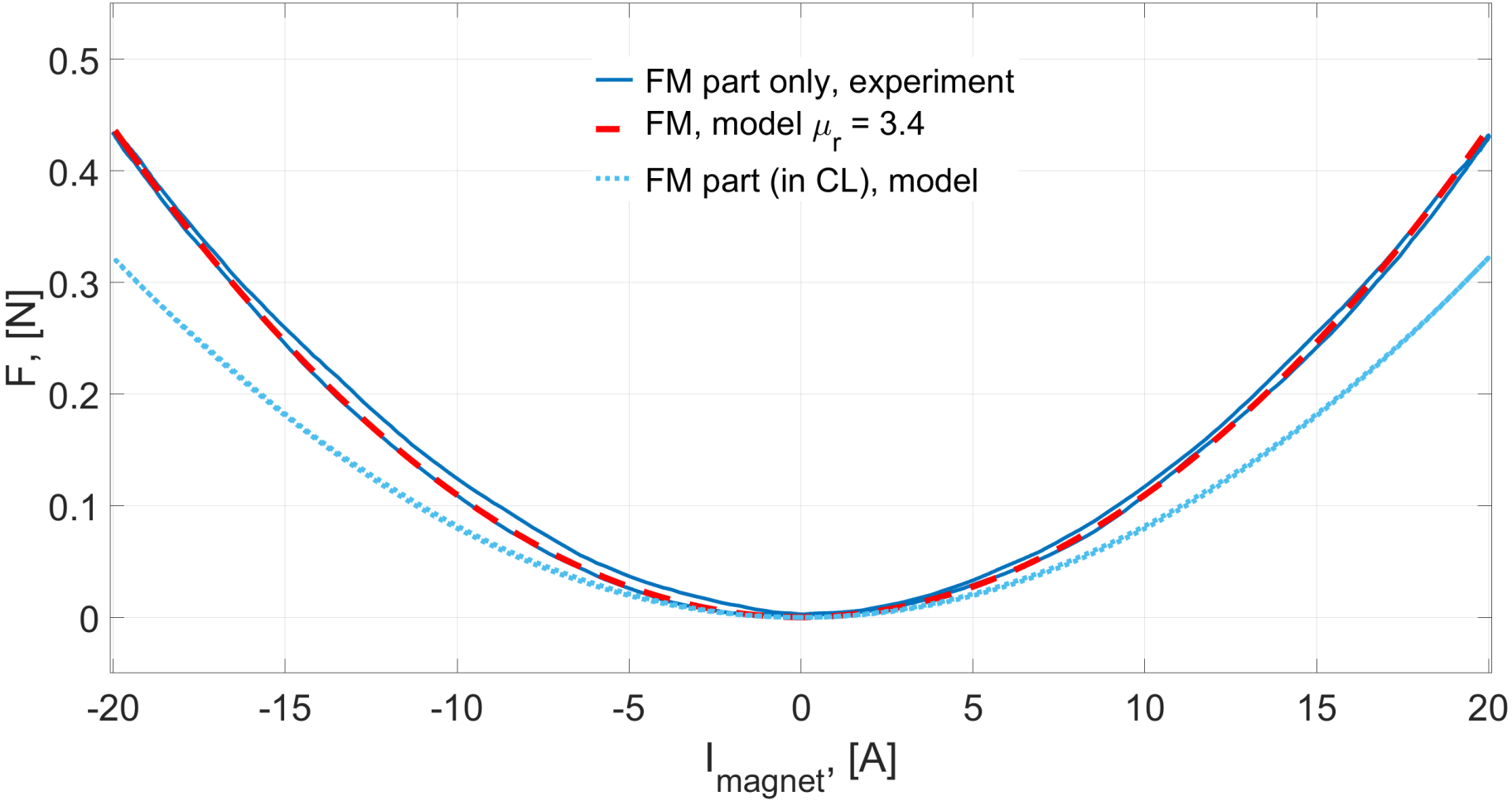

Conclusions:

Advantages of A-formulation in Comsol Multiphysics:

- Suitable for modelling bulk and thin layer superconductors (CC).
- Tolerates using weak mesh resolution.
- Jiles-Atherton hysteresis behaviour of ferromagnetic may be incorporated into the model.
- Allows extracting forces and torques for model components (important for modelling the rotating machinery).

Something else?

Known limitations:

- Works properly for limited dB/dt range.
- Not suitable for over-critical states simulation.
- The coupling of two and more superconductors is not implemented yet.