



HAL
open science

Emulation of Photovoltaic Arrays Using a Programmable DC Power Supply

Shahin Hedayati Kia

► **To cite this version:**

Shahin Hedayati Kia. Emulation of Photovoltaic Arrays Using a Programmable DC Power Supply. Symposium de Génie Electrique, Jul 2021, Nantes, France. hal-03290534

HAL Id: hal-03290534

<https://hal.science/hal-03290534>

Submitted on 19 Jul 2021

HAL is a multi-disciplinary open access archive for the deposit and dissemination of scientific research documents, whether they are published or not. The documents may come from teaching and research institutions in France or abroad, or from public or private research centers.

L'archive ouverte pluridisciplinaire **HAL**, est destinée au dépôt et à la diffusion de documents scientifiques de niveau recherche, publiés ou non, émanant des établissements d'enseignement et de recherche français ou étrangers, des laboratoires publics ou privés.

Emulation of Photovoltaic Arrays Using a Programmable DC Power Supply

Shahin HEDAYATI KIA

Laboratoire Modélisation, Information et Systèmes (UR4290)

Université de Picardie “Jules Verne”

shdkia@u-picardie.fr

ABSTRACT – This paper deals with design of a photovoltaic emulator, using a programmable DC power supply. The main idea is to reproduce real current-voltage ($I - V$) characteristic of a photovoltaic array at different values of solar irradiance and cell temperature. The performance of current-mode control strategy, which is well adapted to all operating points of a photovoltaic array, is investigated. The parameters of PI anti-windup current controller are determined by using the step response of DC power supply system to achieve both optimal accuracy and desired time constant. An experimental test bench, based upon a real-time system linked to a 40V/39A programmable DC power supply, is utilized for the assessment of the developed emulator. The obtained results illustrate a good performance of the proposed approach.

Keywords – Photovoltaic emulator, Programmable DC power supply, Renewable energy systems, Real-time simulation.

1. INTRODUCTION

Photovoltaic (PV) arrays are considered as a well known electrical source widely used in decentralized energy production systems. The intermittent behavior of such a renewable source is the main challenge for its integration in a microgrid which is a kind of renewable local power generation, commonly multi-source, and can be operated in grid-connected or off-grid operating modes. In this regard, the performance of microgrids is evaluated by using experimental plants, which are composed of PV arrays, storage devices, conventional power production and small wind turbines all connected to a common DC-link bus through their dedicated converters. Nevertheless, the high cost and requirement of a wide outer surface area are the prime drawbacks of such installations where the power production is fully dependent on varying weather conditions [1, 2]. Emulation of PV modules is an alternative approach which allows reproducing similar environmental conditions in which these last components operate in practice. By using this technique, the identical non-linear current-voltage ($I - V$) characteristic of real PV arrays should be obtained, particularly the dependency of this last result to weather conditions, partial shadow, and load dynamics. Such experimental facility would permit measurements and tests to be realized in both a real environmental condition and a cost-effective manner. In this respect, the development of digital and analog emulators for PV systems has received intensive research interest during the recent years. The control of both linear and switched mode DC-to-DC and DC-to-AC converters is widely studied for testing newly developed algorithms of maximum power point tracking (MPPT). However, this evaluation is hardly possible under the same weather and load conditions in actual PV generation systems. The digital PV emulators, based on switched mode power converters, are more popular due to their flexibility and high efficiency [2]-[4].

The model of PV arrays, the control strategy and the programmable DC power supply are the main parts of such systems. Most of the models developed until now are based upon the mathematical function of $I - V$ relation which is deduced from

the equivalent electrical circuit of PV modules. The estimation of model parameters is also a crucial factor which promises the high performance of designed emulator [5]. It is mainly relied on finding the parameters of nonlinear $I - V$ relation by customizing the curve at three main points : open circuit, maximum power, and short circuit using data provided by commercial PV array data sheet. This approach guarantees the maximum power of the model and the maximum power of the real PV module meeting each other [6]. The computation complexity of the developed model needs to be considered in its implementation in real-time platforms namely digital signal processors (DSPs), microcontrollers and field programmable gate arrays (FPGAs) which have limited hardware resources [4]. Rapid prototyping real-time platform advances such as RTDS, dSPACE, OPAL-RT and National Instrument technologies can accelerate the emulator development [7]-[9]. Direct computation, look-up table, piecewise linear, neural network and PV voltage elimination approaches are used in PV model realization on the real-time systems [3].

Various types of control strategies i.e. direct referencing, hybrid-mode and hill climbing resistance comparison have been also investigated [3]. The direct referencing method is commonly used for PV array emulation due to its simplicity. The main aim of control strategy of PV emulators is to adjust the operating point on $I - V$ curve which depends on the output load. A dynamic needs to be achieved as close as possible to what it can be observed in actual PV modules. Wide range of control techniques have been implemented for emulation of PV arrays namely the reference generation of voltage, current and hybrid of both voltage and current referencing along with resistance comparison method. The referencing method is commonly used in design of PV emulators due to its simplicity. This last technique is classified into current and voltage modes control which provides respectively current ($I = f(V)$) and voltage ($V = f(I)$) references. This corresponds to the utilized model of PV arrays, for controller of the programmable DC power supply at the final stage of PV emulator [3, 4]. In fact, this last stage is a controllable switched mode pulse width modulation (PWM) DC-to-DC or AC-to-DC converter with the identical rated power, voltage and current of actual PV arrays. The utilized DC-to-DC converter topologies are buck, boost, buck-boost, flyback and forward. The duty cycle of PWM signal is the main control variable for operating point rearrangement on $I - V$ curve. It should be noted that most of the AC-to-DC converters, used in PV emulators, include a rectifier at their input stage. The provided DC voltage is fed to the DC-to-DC converter based on the selected topology [3]. Another technique is the utilization of a commercial programmable DC power supply as the power converter stage of PV arrays emulator. This simplifies drastically the emulator development since such devices have already equipped with a voltage controller.

The aim of this article is to demonstrate the main stages of PV emulator design using a commercial programmable DC power

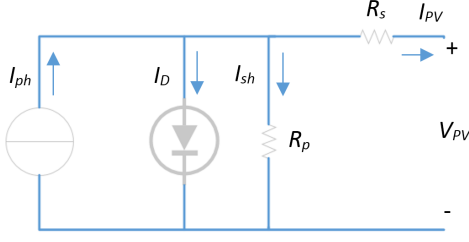

FIG. 1. PV array single diode electrical circuit model.

supply which is a part of dSPACE SCALEXIO hardware-in-the-loop (HIL) simulator system. In such a framework and among all studied control strategies, the current-mode control which defines the operating point current as a function of the operating point voltage ($I = f(I, V)$) is selected and employed in this work. This is particularly suitable in the case where the DC power supply can be programmed through a voltage reference [3]. Besides, the parameters of PI anti-windup current controller of PV emulator are determined by using the step response of the supply system. An experimental test bench including a real-time system linked to a 40V/39A programmable DC power supply is utilized for the assessment of the developed emulator. The experimental results support a good performance of the proposed technique.

2. MODELING OF A PV ARRAY

Single and double diode are two types of electrical circuit models for a PV cell. The single diode model, shown in Fig.1, is a simplified illustration of a PV cell derived from the Shockley diode equation which includes diode quality factor. For accurate modeling of a PV cell, it is necessary to consider the parasitic resistances namely R_p and R_s which represent power loss and current leakage of Shockley diode respectively [2]. The representation of $I - V$ characteristic for N_s series cells in a PV array can be defined according to the implicit relation (1) if the parallel resistance R_p is neglected ($I_{sh} \approx 0$).

$$I_{PV} = I_{ph} - I_S \left\{ \exp \left(\frac{V_{PV} + I_{PV} R_s}{V_t} \right) - 1 \right\} \quad (1)$$

where I_S is the saturation or scale current of Shockley diode in the model (Fig. 1), V_t is the thermal voltage which is given by $V_t = \frac{AkT N_s}{q}$ where A is the quality factor, k_B is the Boltzman constant (1.38×10^{-23} J/K), q is the charge of an electron (1.6×10^{-19}), and T is the temperature expressed in Kelvin. The current source I_{ph} in (1) is proportional to the solar irradiance G and cells temperature T . The parameters namely I_S , I_{ph} and R_s in (1) can be determined based on the knowledge of three main operating points (open circuit voltage V_{oc} , short circuit current I_{sc} and maximum power voltage V_{mp} and maximum power current I_{mp}) of a PV array through the following steps [10]:

- Short-circuit operating point knowing that $V_{pv} = 0$, $I_{ph} \gg I_S$ and neglecting Shockley diode current gives:

$$I_{ph} = I_{sc}(G, T) \quad (2)$$

- Open-circuit working condition assuming $V_{pv} = V_{oc}$ and $I_{pv} = 0$ allows the computation of saturation current as:

$$I_S = \frac{I_{sc}(G, T)}{\exp(V_{oc}(G, T)/V_t(T)) - 1} \quad (3)$$

- Maximum power operating point where $V_{PV} = V_{mp}$ and $I_{PV} = I_{mp}$ yields the estimation of series resistance:

$$R_s = \frac{\ln \left(\frac{I_{sc}(G, T) - I_{mp}(G, T)}{I_S(G, T)} \right) \times V_t(T) - V_{mp}(G, T)}{I_{mp}(G, T)} \quad (4)$$

with

$$V(G, T) = V + k_v(T - T_{ref}) + V_t(T) \times \log \left(\frac{G}{G_{ref}} \right) \quad (5)$$

$$I(G, T) = \frac{G}{G_{ref}} (I + k_i(T - T_{ref})) \quad (6)$$

where variable V in (5) represents V_{oc} and V_{mp} and variable I in (6) represents I_S , I_{sc} and I_{mp} . k_v and k_i are voltage and current temperature coefficients respectively.

3. PV ARRAY EMULATOR DESIGN

PV arrays may be composed of several series (N_{ss}) and parallel (N_{pp}) PV modules. Thus, the relation (1) can be represented as

$$I_{PV} = I_{ph} N_{pp} - I_S N_{pp} \left\{ \exp \left(\frac{V_{PV} + I_{PV} R_s \frac{N_{ss}}{N_{pp}}}{V_t N_{ss}} \right) - 1 \right\} \quad (7)$$

where I_{PV} and V_{PV} are the total current and voltage of PV arrays. In this study, the partial shading, which stands for non-uniform distribution of solar irradiance on the PV field surface, is not included in the model. A comprehensive review on PV emulator design techniques has been performed [3]. The main aim is to implement the relation (1) in a real-time system which provides a voltage reference to the AC-to-DC or DC-to-DC power converter. A voltage-based programmable DC power supply simplifies the PV emulator design since the output voltage control is already included in the system. Among different control strategies presented in the literature, the current-mode control (Fig. 2) is well adapted into both relations (1) and (7). In this method, the reference current I_{PV-ref} is determined after the real-time estimation of I_{ph} , I_S and R_s parameters at each computation step of the model using (2)-(6) as it is shown in Fig. 3. This approach requires voltage V_{PVm} and current I_{PVm} measurements at the output of PV arrays emulator which can be programmed through V_{cm} as it is illustrated in Fig. 2.

$$I_{PV}[k] = I_{ph} N_{pp} - I_S N_{pp} \left\{ \exp \left(\frac{V_{PVm}[k] + I_{PVm}[k] R_s \frac{N_{ss}}{N_{pp}}}{V_t N_{ss}} \right) - 1 \right\} \quad (8)$$

It is also possible to use only the measured voltage V_{PVm} to determine I_{PV-ref} by using root-finding algorithm based upon Newton-Raphson technique as it was suggested [9].

The parameters of anti-windup PI controller, shown in Fig. 2, are defined based on the step response of programmable DC power supply to achieve the optimal accuracy and the desired time constant. In this work, the classical zero-pole cancellation technique is utilized for this purpose by assuming a first-order transfer function for the programmable DC power supply.

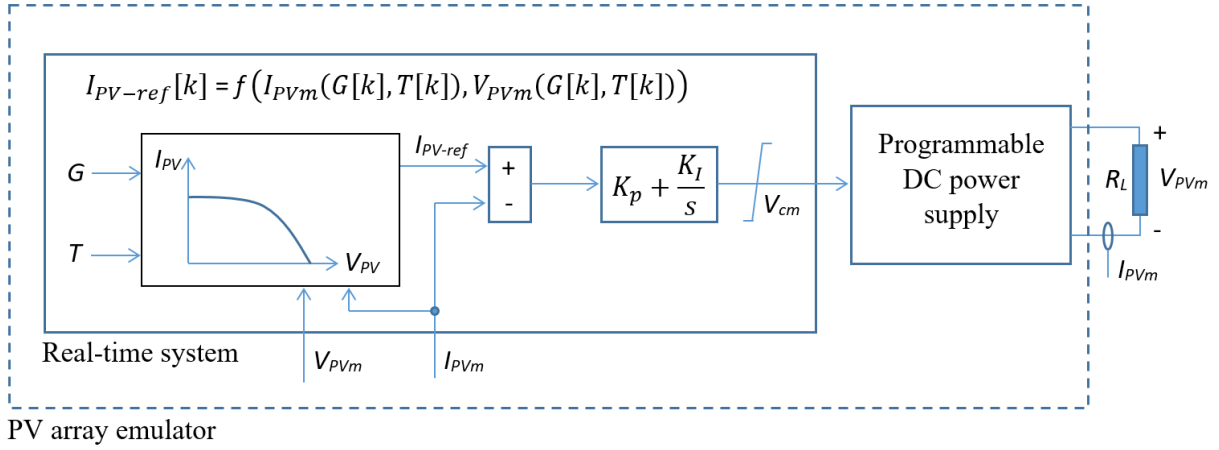

FIG. 2. General scheme of current-mode control technique.

TABLE 1. Main parameters of 300Wc emulated PV array.
($G = 1000W/m^2$ and $T = 25C$)

N_s	V_{oc}	I_{sc}	I_{mp}	V_{mp}	k_v	k_i
36	39.8V	9.75A	9.4 A	31.9V	$-132.3 \times 10^{-3}V/K$	$4.5 \times 10^{-3}A/K$

4. EXPERIMENTAL RESULTS

A 300Wc PV module ($N_{ss} = 1$ and $N_{pp} = 1$) with electrical characteristics shown in Table I is selected for emulation. The real-time system, on which the PV model is implemented, is equipped with a target PC with an Intel CPU E4-1275 V3 of 3.8Ghz clock rate. A commercial voltage-based programmable DC power supply with 40V rated voltage and 39A ra-

ted current is used for delivering the power to the load (Fig. 4). The PI anti-windup controller utilizes the forward Euler method for numerical integration with $T_s = 10^{-4}$ sampling time. The parameters of PI anti-windup controller are determined as $K_p = 0.25$ and $K_I = 100$ to obtain both a good accuracy and a requested time constant of $\tau_r = 20ms$. A programmable resistive load is linked to the output of the programmable DC power supply to evaluate the performance of PV module emulator as it is depicted (Fig. 4). The resistive load R_L is customized according to $R_L = 100, 90, \dots, 20, 10, 9, 8, \dots, 2, 1 \Omega$ in a decreasing sequence to track the important operating points on $I - V$ curve at different values of solar irradiance and cell temperature. The voltage V_{PVm} and current I_{PVm} at the emulator output are illustrated at cell temperatures $T = 25C$ (Fig. 5), $T = 30C$ (Fig. 6) and $T = 50C$ (Fig. 7) and solar irradiances $G = 1000W/m^2, 800W/m^2, 600W/m^2$ and

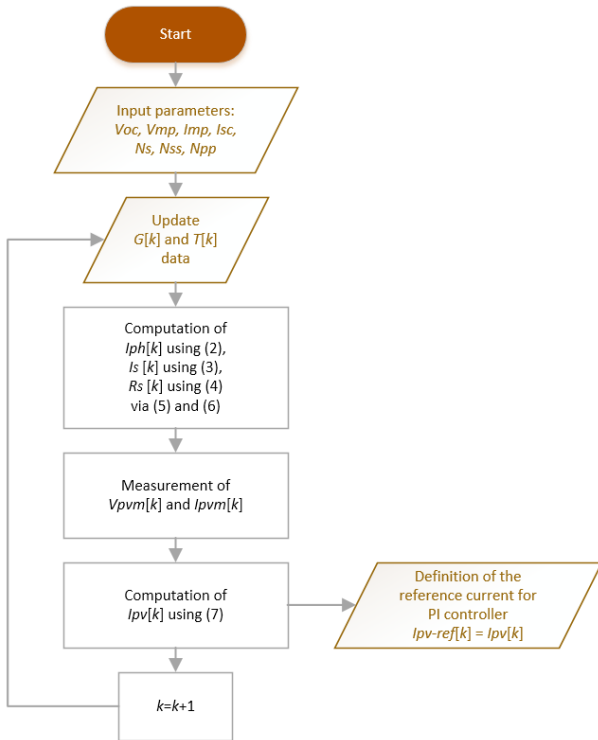

FIG. 3. Implementation of PV arrays model in the real-time system.

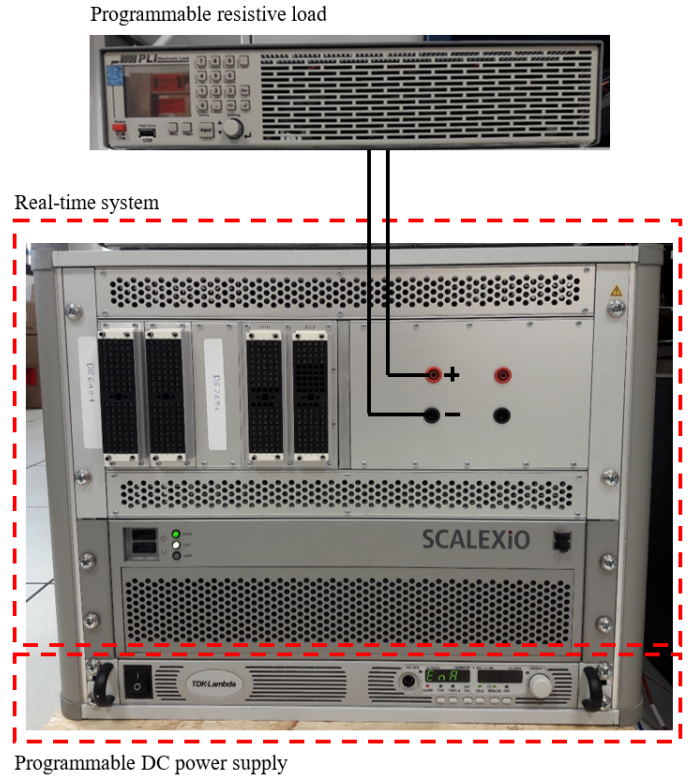

FIG. 4. Scheme of PV modules emulator.

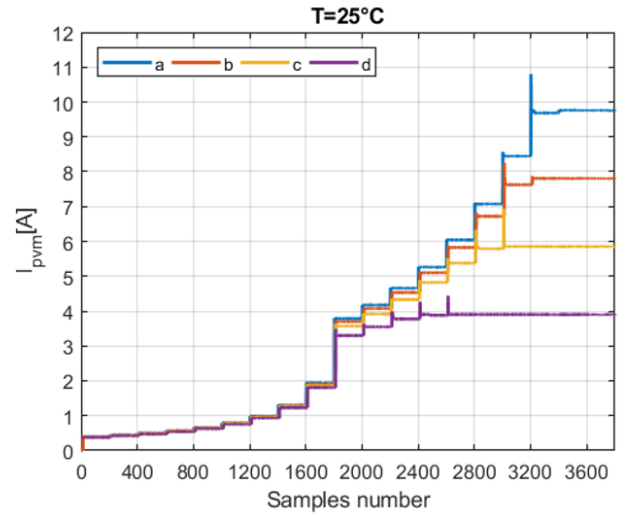
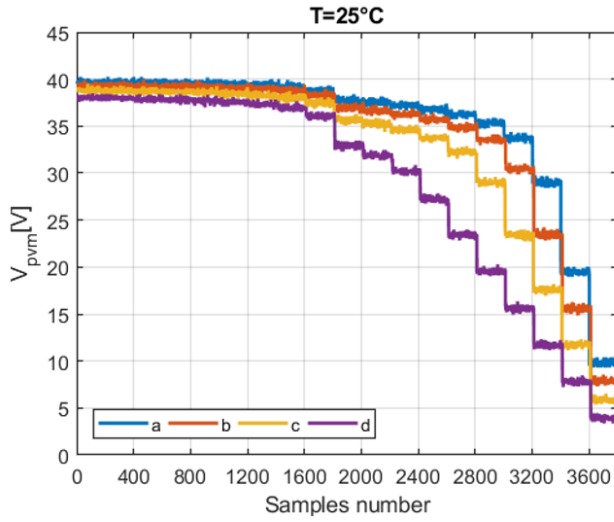

FIG. 5. V_{pvm} [V] and I_{pvm} [A] at resistive load $R_L = 100, 90, \dots, 20, 10, 9, 8, \dots, 2, 1 \Omega$ at $T = 25C$:
 (a) $G = 1000W/m^2$ - (b) $G = 800W/m^2$ - (c) $G = 600W/m^2$ - (d) $G = 400W/m^2$.

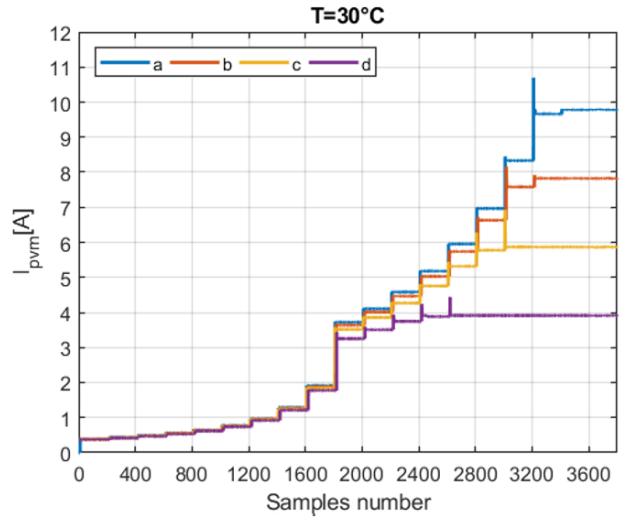
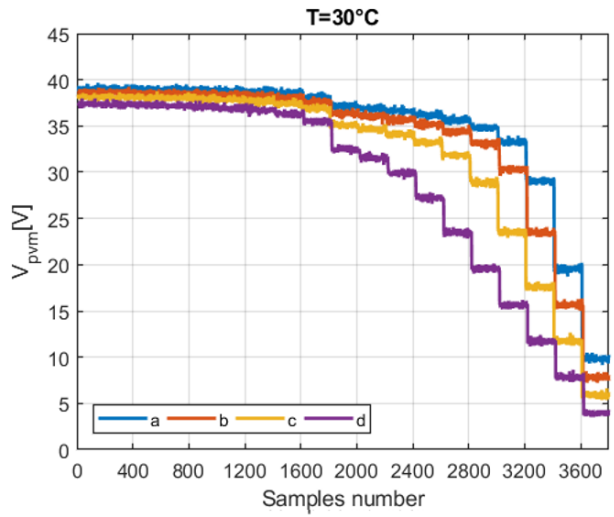

FIG. 6. V_{pvm} [V] and I_{pvm} [A] at resistive load $R_L = 100, 90, \dots, 20, 10, 9, 8, \dots, 2, 1 \Omega$ at $T = 30C$:
 (a) $G = 1000W/m^2$ - (b) $G = 800W/m^2$ - (c) $G = 600W/m^2$ - (d) $G = 400W/m^2$.

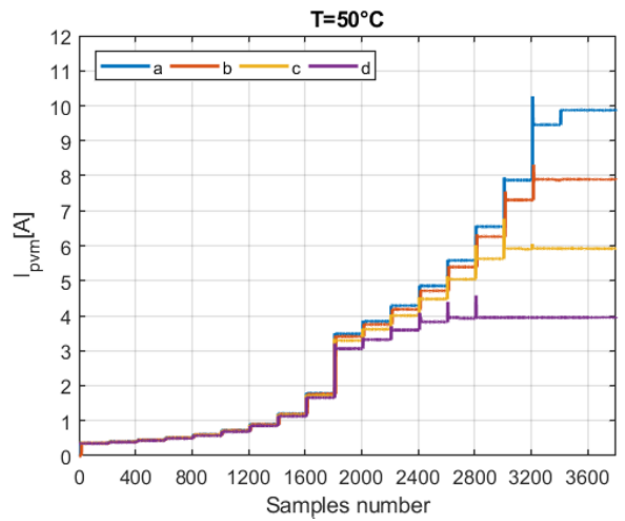
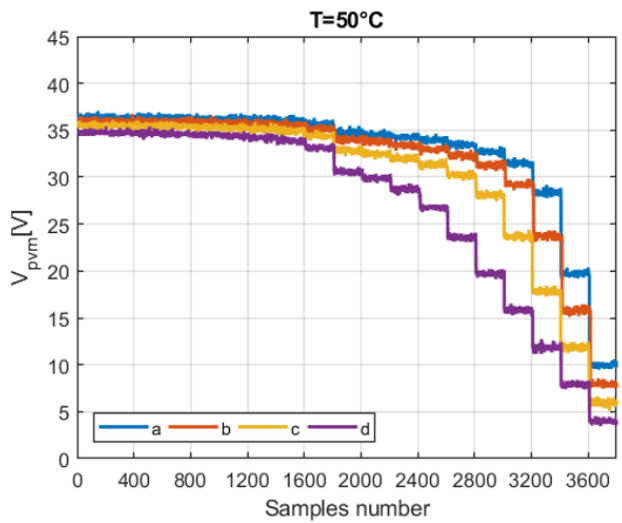

FIG. 7. V_{pvm} [V] and I_{pvm} [A] at resistive load $R_L = 100, 90, \dots, 20, 10, 9, 8, \dots, 2, 1 \Omega$ at $T = 50C$:
 (a) $G = 1000W/m^2$ - (b) $G = 800W/m^2$ - (c) $G = 600W/m^2$ - (d) $G = 400W/m^2$.

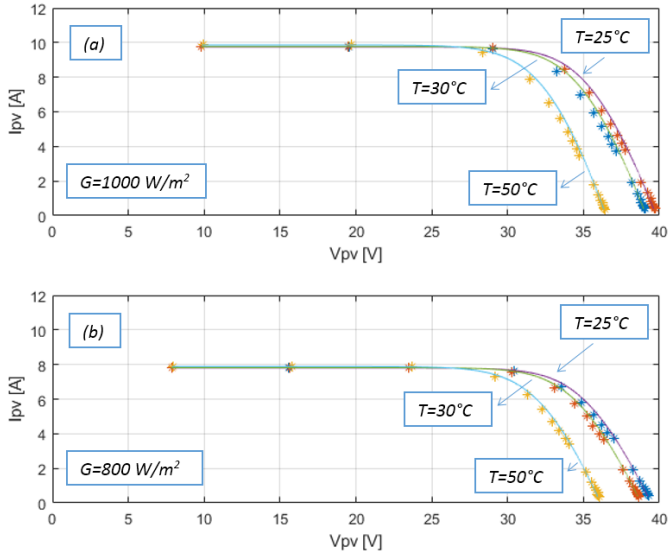

FIG. 8. $I_{PV} - V_{PV}$ theoretical curve ("—") and (I_{PV}, V_{PV}) measured operating points at load R_L in between 1Ω and 100Ω ("*") at $T = 25^\circ C, 30^\circ C$ and $50^\circ C$: (a) $G = 1000W/m^2$ - (b) $G = 800W/m^2$.

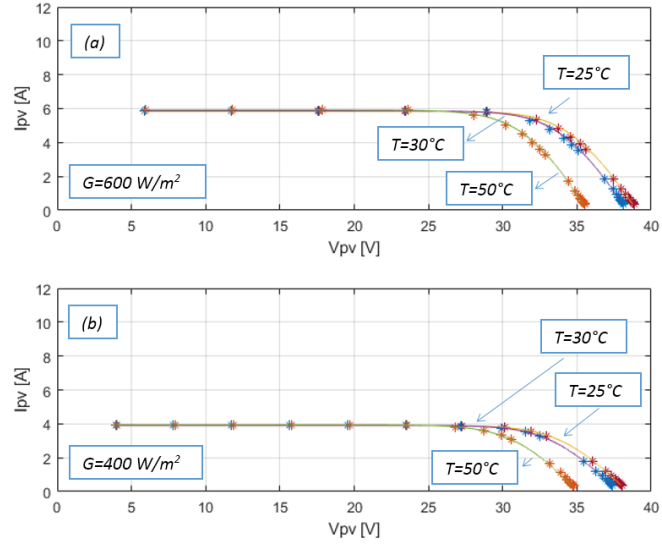

FIG. 9. $I_{PV} - V_{PV}$ theoretical curve ("—") and (I_{PV}, V_{PV}) measured operating points at load R_L in between 1Ω and 100Ω ("*") at $T = 25^\circ C, 30^\circ C$ and $50^\circ C$: (a) $G = 600W/m^2$ - (b) $G = 400W/m^2$.

$400W/m^2$ respectively. The average measured voltage V_{pvm} and measured current I_{pvm} at the output of PV emulator is determined over 100 measured samples in order to evaluate the performance of PV emulator in the steady state condition. The experiments related to these operating points (I_{PV}, V_{PV}) at $G = 1000W/m^2, 800W/m^2, 600W/m^2$ and $400W/m^2$ and $T = 25^\circ C, 30^\circ C$ and $50^\circ C$ are compared with theoretical curves in both Figs. 8 and 9. These last tests have been performed for load variations in between $R_L = 1\Omega$ and $R_L = 100\Omega$. The results demonstrate a good performance of the selected approach for emulation of PV arrays.

5. CONCLUSIONS

This paper presents a method based on current-mode control strategy for emulation of PV arrays. In this approach, the implicit form i.e. $I = f(I, V)$ is used to deliver a reference current to the anti-windup PI controller for programming a DC power supply. The experimental results illustrate a good performance

of the designed PV emulator in steady-state condition.

6. REFERENCES

- [1] M. Sechilariu, and F. Locment, « Urban DC microgrid intelligent control and power flow optimization », Elsevier Publisher, 2016, General introduction, p. xxi-xxiii.
- [2] M. C. Di Piazza, and G. Vitale, « Photovoltaic sources modeling and emulation », Springer International Publisher, 2013, Chapter 6, p. 173-202.
- [3] R. Ayop, and C. W. Tan, « A comprehensive review on photovoltaic emulator », Renewable and Sustainable Energy Reviews, vol. 80, p. 430-451, May 2017.
- [4] J. P. Ram, H. Manghani, D. S. Pillai, T. S. Babu, M. Miyatake, and N. Rajasekar « Analysis on solar PV emulators : A review », Renewable and Sustainable Energy Reviews, vol. 81, p. 149-160, 2018.
- [5] A. Rezaee Jordehi, « Parameter estimation of solar photovoltaic (PV) cells : A review », Renewable and Sustainable Energy Reviews, vol. 61, p. 354-371, 2016.
- [6] M. G. Villalva, J. R. Gazoli, and E. R. Filho, « Comprehensive approach to modeling and simulation of photovoltaic arrays », IEEE Transactions on Power Electronics, vol. 24, no. 5, p. 1198-1208, May 2009.
- [7] D. S. L. Dolan, J. Durago, and Taufik, « Development of a photovoltaic panel emulator using Labview », in Proc. 37th IEEE Photovoltaic Specialists Conference, Seattle (USA), 19-24 June 2011, p. 1795-1800.
- [8] M. Park, and I.-K. Yu, « A novel real-time simulation technique of photovoltaic generation systems using RTDS », IEEE Transactions on Energy Conversion, vol. 19, no. 1, p. 164-169, March 2004.
- [9] D. Abbes, A. Martinez, G. Champenois, and B. Robyns, « Real-time supervision for a hybride renewable power system », Simulation Modeling Practice and Theory, vol. 42, p. 53-72, 2014.
- [10] T. Geury, and J. Gyselinck, « Emulation of photovoltaic arrays with shading effect for testing of grid-connected inverters », in Proc. European Conference on Power Electronics and Applications (EPE), Lille (France), 2-6 September 2013, 9 pages.