



HAL
open science

Extending standard urban outdoor noise propagation models to complex geometries

Matthew Kamarath, Philippe Jean, Julien Maillard, Judicaël Picaut,
Christophe Langrenne

► To cite this version:

Matthew Kamarath, Philippe Jean, Julien Maillard, Judicaël Picaut, Christophe Langrenne. Extending standard urban outdoor noise propagation models to complex geometries. *Journal of the Acoustical Society of America*, 2018, 143 (4), pp.2066-2075. 10.1121/1.5027826 . hal-03288502

HAL Id: hal-03288502

<https://hal.science/hal-03288502>

Submitted on 16 Jul 2021

HAL is a multi-disciplinary open access archive for the deposit and dissemination of scientific research documents, whether they are published or not. The documents may come from teaching and research institutions in France or abroad, or from public or private research centers.

L'archive ouverte pluridisciplinaire **HAL**, est destinée au dépôt et à la diffusion de documents scientifiques de niveau recherche, publiés ou non, émanant des établissements d'enseignement et de recherche français ou étrangers, des laboratoires publics ou privés.

Extending standard urban outdoor noise propagation models to complex geometries^{a)}

Matthew Kamrath,^b Philippe Jean, and Julien Maillard

CSTB, 24 Rue Joseph Fourier, Saint-Martin-d'Hères 38400,

France

Judicaël Picaut

IFSTTAR, AME, LAE, Bouguenais 44344, France

Christophe Langrenne

LMSSC/CNAM, Paris Cedex 03 75141, France

(Dated: 26 February 2018)

1 A hybrid method that combines a noise engineering method and the 2.5D bound-
2 ary element method approximates outdoor sound propagation in large domains with
3 complex objects more accurately than noise engineering methods alone and more
4 efficiently than reference methods alone. Noise engineering methods (e.g. ISO 9613-
5 2 or CNOSSOS-EU) efficiently approximate sound levels from roads, railways, and
6 industrial sources in cities for simple, box-shaped geometries by first finding the
7 propagation paths between the source and receiver, then applying attenuations (e.g.
8 geometrical divergence and atmospheric absorption) to each path, and finally inco-
9 herently summing all of the path contributions. Standard engineering methods can-
10 not model more complicated geometries, but introducing an additional attenuation
11 term quantifies the influence of complex objects. Calculating this extra attenuation
12 term requires reference calculations, but performing reference computations for each
13 path is too computationally expensive. Thus, the extra attenuation term is linearly
14 interpolated from a data table containing the corrections for many source/receiver
15 positions and frequencies. The 2.5D boundary element method produces the levels
16 for the real and simplified geometries, and subtracting them yields a table of correc-
17 tions. For a T-shaped barrier with two buildings, this approach reduces the mean
18 error by approximately 2 dBA compared to a standard engineering method.

^aPortions of this work were presented in “The initial development of a hybrid method for modeling outdoor sound propagation in urban areas,” 170th Meeting of the Acoustical Society of America, Jacksonville, Florida, November 2015; “Modeling outdoor sound propagation in urban environments,” 171st Meeting of the Acoustical Society of America, Salt Lake City, Utah, May 2016; “Augmenting Road Noise Engineering Methods using the Boundary Element Method,” Inter-noise, Hamburg, Germany, August 2016; and “En-
2 abling noise engineering methods to model complex geometries,” 3rd Joint Meeting of the Acoustical Society of America and the European Acoustics Association, Boston, Massachusetts, June 2017.

19 I. INTRODUCTION

20 Excessive environmental noise exposure from road, rail, airport, and industrial sources
21 is a major health concern. In Western Europe, the World Health Organization estimates
22 that over 1 million healthy life years are lost annually due to increased annoyance, sleep
23 disturbance, and other negative health outcomes from traffic-related noise¹. In response, the
24 European Parliament passed the Environmental Noise Directive 2002/49/EC² to evaluate
25 and mitigate current noise levels and developed the Common Noise Assessment Methods in
26 Europe (CNOSSOS-EU)³ to standardize noise prediction models.

27 However, modeling urban outdoor sound propagation is very difficult because cities are
28 large compared to a wavelength and contain complicated geometries. Specifically, the domain
29 is three dimensional and is the size of multiple city blocks (i.e. at least 100 m), and the
30 frequency range goes up to the 4 kHz octave-band, so in air the wavelength can be less than
31 0.1 m. Thus, common reference approaches in outdoor sound propagation that discretize
32 the entire domain with multiple points per wavelength like the finite element^{4,5}, boundary
33 element^{6,7}, and finite-difference methods^{8,9} are prohibitively expensive.

34 In addition, urban scenes often have complicated geometries and impedances, which must
35 be modeled accurately because they can significantly impact the level at the receiver¹⁰. A
36 principal example is a complex noise barrier, which could be a T-shaped barrier¹¹ or even a
37 barrier with an optimized shape^{12,13}. This criterion eliminates the engineering methods (e.g.
38 CNOSSOS-EU, ISO 9613-2¹⁴, and Harmonoise^{15,16}) because they are not designed to model
39 such complex shapes and geometrical approaches more generally (e.g. ray tracing^{17,18} or

40 beam tracing^{19,20}) because these complex shapes would require too many diffracting edges
41 to model them efficiently. In addition, the parabolic equation method^{21,22} cannot model
42 such complex geometries because it usually only models one-way propagation²³ to improve
43 computational efficiency.

44 In addition to these standard approaches, many hybrid methods cannot model large 3D
45 domains with complex geometries. Many hybrid approaches combine methods using spatial
46 decomposition, which applies a reference method to geometrically complex regions and an
47 efficient method to geometrically simple regions. For example, using spatial decomposition
48 one can combine the finite-difference time-domain and parabolic equation methods²⁴, the
49 boundary element and parabolic equation methods²⁵, or the boundary element and ray
50 tracing methods^{26–28}. All of these methods use a reference method to calculate the pressure
51 on a fictitious surface around the complex area and propagate those pressures using an
52 efficient method. However, the number of points on this fictitious surface increases with
53 frequency, so for high frequencies and 3D geometries the cost can be prohibitive. Indeed,
54 most of the applications in those papers are only two dimensional or only use low frequencies.

55 To mitigate this problem, Yeh et al.²⁹ apply both spatial and frequency decomposition,
56 which uses a reference method for low frequencies near complex objects and an efficient
57 method otherwise. This approach makes the cost scale linearly with the largest dimension
58 of the domain instead of the domain volume, but it still requires expensive reference method
59 calculation for every new scene. Performing a reference calculations for each complex object
60 instead of each scene is potentially much less expensive but also less accurate.

61 The literature proposes two principle ways to quantify the influence of a complex object.
62 The first method performs a large number of reference calculations and then fits an analytical
63 curve to the data^{30,31}. Evaluating the function at a given source and receiver yields the
64 associated correction. This approach has the potential to substantially reduce the amount
65 of data that must be stored because the data is approximated with an analytical curve.
66 However, this approach limits the number of data points to about 10,000 because it requires
67 a matrix inversion, which uses $O(n^3)$ operations. The second method stores a large table of
68 reference computations and then interpolates the results depending on the source/receiver
69 positions and frequency^{32,33}. In this approach, the number of data points is only limited by
70 the available computer memory. Thus, the hybrid method tabulates many reference results
71 and interpolates them.

72 The current literature is limited because it does not explain how to apply the calculated
73 corrections in a complex urban scene with other objects and does not test the approach. This
74 article seeks to fill this gap by developing and validating a hybrid approach that combines
75 an engineering method and the 2.5D boundary element method. To that end, Section II
76 explicates the hybrid method and Section III evaluates it for three test cases using a T-
77 barrier.

78 II. THE HYBRID METHOD

79 To determine the level at a receiver, engineering methods 1) input the scene information,
80 2) find the propagation paths between the source and receiver, 3) calculate the attenua-
81 tions for each path, and 4) sum the contributions of each propagation path. Summing the

directional source level and attenuations yields the path contributions:

$$L = L_w + A_{\text{div}} + A_{\text{atm}} + A_{\text{boundary}} , \quad (1)$$

where L is the sound pressure level at the receiver, L_w is the directional sound pressure level of the source, A_{div} is the attenuation due to geometrical divergence, A_{atm} is the attenuation due to atmospheric absorption, and A_{boundary} is the attenuation due to the ground effect, reflecting from vertical surfaces, and diffracting over/around objects. All of the terms are in decibels and typically computed for each octave or third-octave band.

The hybrid method described here combines an engineering method and a reference method to efficiently approximate outdoor noise propagation with complex objects. The hybrid method modifies Equation (1) by introducing an extra attenuation term for the complex objects:

$$L = L_w + A_{\text{div}} + A_{\text{atm}} + A_{\text{boundary}} + A_{\text{extra}} , \quad (2)$$

where A_{extra} is the attenuation due to complex object compared to a simplified object. Calculating this term requires reference computations that can model the complex shape accurately, but performing a reference calculation for every propagation path would be prohibitively expensive. Instead, the hybrid method tabulates a large number of reference results, which is then interpolated as needed.

Thus, the hybrid method requires some reference computations before the engineering method begins. First, the reference method [e.g. the boundary element method (BEM)] calculates the attenuation of the complex object compared to a simple object for a large number of source/receiver locations and frequencies. Second, the data is sorted and converted to frequency-band data for the engineering method. These expensive steps are only

102 required once for each complex object because the results can be stored for later use. Then,
 103 the engineering method can proceed. Figure 1 outlines these steps.

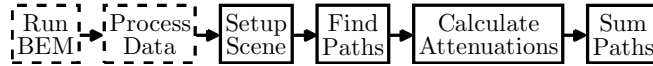

FIG. 1. Outline of the hybrid method. The dashed boxes indicate that these steps are not always required.

104 After the engineering method finds all the paths, the extra attenuation must be calculated
 105 for each path just like all of the other attenuations. If a propagation path diffracts over a
 106 complex object that has the largest path length difference of any object in that path, then
 107 the extra attenuation could be non-zero; otherwise, the extra attenuation is zero. If the extra
 108 attenuation could be non-zero, then the engineering method uses the path geometry to find
 109 the local source/receiver position. Then, linearly interpolating the table of corrections at
 110 that position produces the extra attenuation.

111 The rest of this section gives greater detail about the hybrid method. Specifically, Section
 112 II A explains how to calculate the table of corrections, Section II B elucidates how to convert
 113 the source/receiver coordinates in the engineering method to the coordinates in the table
 114 of corrections, Section II C describes how to interpolate the table of corrections to produce
 115 the extra attenuation, and Section II D discusses what to do when a point is outside of the
 116 table of corrections.

117 A. Calculating the table of corrections

118 The first step in the hybrid method is calculating the table of corrections. While in
 119 general any approach capable of modeling complex geometries and arbitrary impedances
 120 could be used, the 2.5D boundary element method (BEM) is particularly well suited for this
 121 application. First, BEM efficiently models infinite domains, which are required in outdoor
 122 sound propagation, by imposing the Sommerfeld radiation conditions to only allow outgoing
 123 waves and by modifying the free space Green’s function using an image source to model
 124 infinite flat ground. Second, 2.5D BEM¹⁰ models infinitely long objects with an arbitrary,
 125 constant cross-section as an integral of 2D problems³⁴. Thus, instead of using 3D elements
 126 throughout the domain, 2.5D BEM only has to mesh the 1D perimeter of the object’s cross-
 127 section. For computational efficiency, the complex geometries are restricted to objects that
 128 are long compared to a wavelength and have a constant (arbitrary) cross-section along the
 129 long dimension. Using 2.5D BEM also allows the source to be a point source instead of a
 130 coherent line source, which affects the predicted attenuation³⁵.

131 The next step is to define the variables for the table of corrections. The source/receiver
 132 positions and the frequency clearly affect the attenuation of a complex object, which in
 133 arbitrary 3D space requires seven variables. However, since the object is infinitely long
 134 in one direction, only the relative position of the source and receiver is required parallel
 135 to the object. Thus, there are six variables (Figure 2): x_s and x_r are the perpendicular
 136 displacements (i.e. x_s is negative and x_r is positive) of the source and receiver from the
 137 object, z_s and z_r are the heights of the source and receiver relative to the bottom of the

138 complex object, Δy is the distance between the source and receiver that is parallel to the
 139 complex object, and f is the frequency.

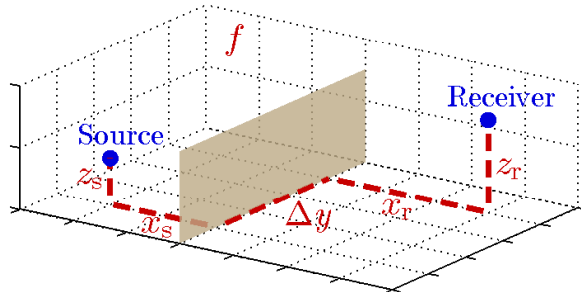

FIG. 2. (Color online) The variable definitions for the table of corrections.

140 The next step is to define the source and receiver positions. To minimize the memory
 141 and time costs of interpolating the data, the data points are constrained to a non-uniform
 142 grid. The range of each variable depends on the application; for example, the source/receiver
 143 positions may be different for modeling road noise versus industrial noise. Also, since the
 144 extra attenuation probably changes most rapidly near the complex object and the ground,
 145 the values of the individual variables follow an exponential function for simplicity, which
 146 Section III demonstrates. With six variables, the amount of data increases very rapidly
 147 with the number of points per variable. Using only 20 points per variable, the total number
 148 of points would be $20^6 = 6.4 \times 10^7$ points.

149 The last step before calculating the points is deciding the geometry of the simplified
 150 object and the surroundings. The simplified object changes depending on the complex
 151 object, but 1) the engineering method must be able to model it and 2) it should be as
 152 similar as possible to the complex object. For example, the simplified object for a complex
 153 barrier would be a straight barrier (i.e. an I-barrier) that is the same height as the complex

154 barrier. The complex and simplified objects should be similar because the hybrid method
 155 assumes that the extra attenuation is mostly independent of the surrounding geometry.
 156 This assumption is not true in general but is approximately true for sufficiently similar
 157 geometries. For simplicity and computational efficiency, if the ground is approximately flat,
 158 then the surrounding geometry is hard flat ground. Section III B suggests that hard, flat
 159 ground even gives reasonable results when the eventual complex surroundings do not have
 160 hard ground. The most important reason for only using hard ground is that it drastically
 161 decreases the number of necessary tables of corrections. If the ground is not flat, then the
 162 non-flat portions would need to be meshed in BEM, which is possible but more costly.

163 After performing the BEM computations, the data must be converted from single fre-
 164 quency calculations to octaves or third-octaves to interface with the engineering methods.
 165 Given N complex pressures p_i that are computed at the linearly spaced frequencies f_i in
 166 the frequency range $[f_{\min}, f_{\max}]$ (i.e. $f_i = \frac{f_{\max} - f_{\min}}{N} (i - \frac{1}{2})$ for $i = [1, N]$) and the reference
 167 pressure p_{ref} , the corresponding frequency band level is

$$L = 10 \log_{10} \left(\frac{f_{\max} - f_{\min}}{N} \sum_{i=1}^N \frac{|p_i|^2}{p_{\text{ref}}^2} \right), \quad (3)$$

168 where N is sufficiently large for the sum to converge, which is typically about ten frequencies.
 169 This calculation is performed for each frequency band, for each source/receiver pair, and for
 170 both the simplified and complex cases. Then, subtracting the levels for the simplified case
 171 $L_{\text{simplified}}$ from the levels for the complex case L_{complex} for every frequency and source/receiver
 172 pair yields the table of corrections ΔL :

$$\Delta L = L_{\text{complex}} - L_{\text{simplified}}. \quad (4)$$

173 Here, ΔL refers to values that depend on the source/receiver positions and frequency and
 174 that are stored in a table, which is later interpolated to determine the extra attenuation
 175 A_{extra} of a given propagation path. The table of corrections must be interpolated because
 176 the propagation path could have a source/receiver location that is not in the table.

177 Finally, the points are sorted based on the source/receiver locations to make interpolating
 178 the data more efficient.

179 B. Local source/receiver positions

180 The variables in the table of corrections (i.e. $x_s, z_s, x_r, z_r, \Delta y$) are defined relative to the
 181 complex object, but the variables that the engineering method uses are not. Specifically, the
 182 engineering method uses two sets of coordinates (Figure 3). First, it uses standard Cartesian
 183 coordinates $(x_{\text{global}}, y_{\text{global}}, z_{\text{global}})$ for all of the objects where the origin and orientation of
 184 the axes are arbitrarily chosen by the user. In addition, all of the points along a propagation
 185 path also get a second pair of coordinates $(d_{\text{path}}, z_{\text{path}})$ where d_{path} is the distance along the
 186 path and z_{path} is the height of the path. Thus, the global variables of the engineering method
 187 must be converted to the local coordinates of the table of corrections to interpolate it.

188 The first step is to determine the smallest angle θ between the complex object and the
 189 propagation path (Figure 3). Using the dot product and the locations of the ends of the
 190 complex object, the source, and the receiver, the angle θ is

$$\theta = \cos^{-1} |\hat{\mathbf{r}}_{\text{global},s \rightarrow r} \cdot \hat{\mathbf{r}}_{\text{global},b_1 \rightarrow b_2}| \quad , \quad (5)$$

191 where $\hat{\mathbf{r}}_{\text{global},r \rightarrow s}$ is a 2D $(x_{\text{global}}, y_{\text{global}})$ unit vector parallel to the propagation path at the
 192 diffraction point and $\hat{\mathbf{r}}_{\text{global},b_1 \rightarrow b_2}$ is a 2D unit vector parallel to the complex object at the
 193 diffraction point. If there are more than three propagation points [e.g. (s, p_1, d, p_2, r) instead
 194 of (s, d, r) where p_1 is a reflection point and p_2 is a lateral diffraction point], then $\hat{\mathbf{r}}_{\text{global},s \rightarrow r}$
 195 would become $\hat{\mathbf{r}}_{\text{global},p_1 \rightarrow p_2}$ to keep the unit vector parallel to the propagation path at the
 196 diffraction point.

197 After calculating θ , applying geometry in Figure 3 yields all the local variables:

$$x_s = [d_{\text{path}}(s) - d_{\text{path}}(d)] \sin \theta , \quad (6a)$$

$$z_s = z_{\text{path}}(s) , \quad (6b)$$

$$x_r = [d_{\text{path}}(r) - d_{\text{path}}(d)] \sin \theta , \quad (6c)$$

$$z_r = z_{\text{path}}(r) , \quad (6d)$$

$$\Delta y = [d_{\text{path}}(r) - d_{\text{path}}(s)] \cos \theta , \quad (6e)$$

198 where $d_{\text{path}}(s)$, $d_{\text{path}}(d)$, and $d_{\text{path}}(r)$ are d_{path} at the source, diffraction point, and receiver;
 199 and $z_{\text{path}}(s)$ and $z_{\text{path}}(r)$ are z_{path} at the source and receiver. Since d_{path} increases from the
 200 source to the receiver, all of the variables are positive except x_s , which is always negative.

201 C. Linear interpolation

202 Once the local source/receiver position $(\mathbf{x} = x_s, z_s, x_r, z_r, \Delta y)$ is determined, the next
 203 step is to interpolate the table of corrections at this point. The hybrid method uses k -linear
 204 spline interpolation where k is the number of dimensions because this interpolation method

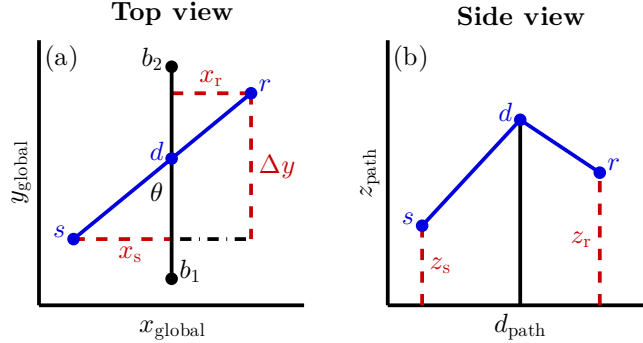

FIG. 3. (Color online) Converting the global coordinates used in the engineering method to the local coordinates used in the table of corrections.

205 works well for data on a grid. Although the real application has five dimensions (i.e. $k = 5$),
 206 first consider a simpler 2D example.

207 Spline interpolation breaks the entire region into smaller subregions and only uses the
 208 nearby data points. For 2D data on a grid, each of the subregions is a rectangle with a data
 209 point at each corner. Each data point (x_1, x_2) is uniquely identified using two indices (i_1, i_2)
 210 just like in a 2D matrix. The corners of a rectangle are the data points with the indices
 211 (i_1, i_2) , $(i_1, i_2 + 1)$, $(i_1 + 1, i_2)$, and $(i_1 + 1, i_2 + 1)$, so each rectangle can be uniquely identified
 212 using the smallest indices (i_1, i_2) of the rectangle. For each dimension, the smallest index of
 213 a rectangle is the largest index that has a position less than or equal to the position of the
 214 interpolation point.

215 Given an interpolation point, the first step is to determine the indices of the rectangle
 216 that contains the interpolation point. For an arbitrary grid, the most efficient method is to
 217 use a binary search for each dimension, which uses $O(\log n)$ operations. Assuming sorted
 218 data, a binary search starts at the center index and determines if the position of that index

219 is too small, the correct point, or too big. If the position is the correct point, then the search
 220 algorithm terminates. Otherwise, the process repeats with the remaining data (i.e. the data
 221 that is larger if the position is too small or the data that is smaller if the position is too
 222 large), which is cut in half at each iteration.

223 After identifying the rectangle that contains the interpolation point, the next step is to use
 224 the data at the corners of the rectangle to approximate the value at the interpolation point.
 225 In 2D, k -linear interpolation method is called bilinear interpolation, and the interpolated
 226 value is

$$y(x_1, x_2) = c_{0,0} + c_{1,0}x_1 + c_{0,1}x_2 + c_{1,1}x_1x_2 \quad , \quad (7)$$

227 where the c 's are unknown coefficients and the x 's are the inputs. In the real application,
 228 y is A_{extra} or ΔL and the x 's are x_s, z_s, x_r, z_r , or Δy . Evaluating Equation (7) at the
 229 four corners of the rectangle that contains the interpolation point yields a system of four
 230 equations with four unknown coefficients. Rescaling the x 's to be between zero and one
 231 simplifies the matrix equation to

$$\begin{bmatrix} c_{0,0} \\ c_{0,1} \\ c_{1,0} \\ c_{1,1} \end{bmatrix} = \begin{bmatrix} 1 & 0 & 0 & 0 \\ -1 & 1 & 0 & 0 \\ -1 & 0 & 1 & 0 \\ 1 & -1 & -1 & 1 \end{bmatrix} \begin{bmatrix} y(0,0) \\ y(0,1) \\ y(1,0) \\ y(1,1) \end{bmatrix} \quad . \quad (8)$$

232 Plugging the values of the coefficients from Equation (8) into Equation (7) yields the function
 233 to interpolate the value at any location inside the rectangle.

234 Applying the same procedure to the general dimensional case allows this interpolation
 235 method to model the 5D application. First, determine the indices $(i_1, i_2, i_3, i_4, i_5)$ of the
 236 hyper-rectangle using a binary search for each dimension. Instead of just $2^2 = 4$ points, this
 237 hyper-rectangle contains the $2^5 = 32$ points [i.e. $(i_1, i_2, i_3, i_4, i_5), (i_1, i_2, i_3, i_4, i_5 + 1), \dots, (i_1 +$
 238 $1, i_2 + 1, i_3 + 1, i_4 + 1, i_5 + 1)$]. Second, interpolate using the data at the corners of the
 239 hyper-rectangle. The general dimensional form of Equation (7) is

$$y(\mathbf{x}) = \sum_{m_1, m_2, \dots, m_k=0}^1 c_{m_1, m_2, \dots, m_k} x_1^{m_1} x_2^{m_2} \dots x_k^{m_k}, \quad (9)$$

240 where the sum is over all 2^k combinations of the m 's being zero or one. Evaluating this
 241 equation at the 2^k corners of the hyper-rectangle that contains the interpolation point yields
 242 the 2^k coefficients c_{m_1, m_2, \dots, m_k} . This matrix equation can be solved analytically for an arbi-
 243 trary number of dimensions when all of the coordinates \mathbf{x} are rescaled to be between zero
 244 and one. Specifically,

$$\begin{bmatrix} c_{0,0,\dots,0} \\ c_{0,0,\dots,1} \\ \vdots \\ c_{1,1,\dots,1} \end{bmatrix} = \mathbf{A}_k \begin{bmatrix} y(0, 0, \dots, 0) \\ y(0, 0, \dots, 1) \\ \vdots \\ y(1, 1, \dots, 1) \end{bmatrix}, \quad (10)$$

245 where \mathbf{A}_k is found using the following recursive relationship:

$$\mathbf{A}_0 = 1 \text{ and } \mathbf{A}_{n+1} = \begin{bmatrix} \mathbf{A}_n & 0 \\ -\mathbf{A}_n & \mathbf{A}_n \end{bmatrix}. \quad (11)$$

246 For the current application, the y 's in Equation (10) are the ΔL 's from the table of correc-
 247 tions.

248 Finally, plugging the coefficients from Equation (10) into Equation (9) and evaluating it at
 249 the rescaled interpolation point yields the interpolated value, which is the extra attenuation
 250 A_{extra} for that propagation path.

251 **D. Extrapolation**

252 Sometimes, the desired source/receiver pair falls outside of the range of the table of
 253 corrections. When this occurs, linear interpolation may produce large errors, especially
 254 when the point is far away from the points in the dataset. If many points are outside of the
 255 range of the table of corrections, then the range should be expanded to include these points.
 256 If some points are still outside of the range of the table of corrections, then simplest solution
 257 is to set the extra attenuation to zero outside of the table of corrections. This approach is
 258 discontinuous at the boundary of the dataset, so the hybrid method smooths this transition
 259 by finding the closest data point and multiplying it by a decay function:

$$f(d) = \frac{1}{1 + ad} , \quad (12)$$

260 where d is the standard Euclidean distance extended to 5D between the desired point and
 261 the closest data point and a is a positive coefficient, which can be set to 1 m^{-1} . This decay
 262 function guarantees that the extrapolated values close to the data are similar to the value
 263 of the closest data point but extrapolated values far from the data are close to zero.

264 The exact value of a is unimportant because these long propagation paths are rarely
 265 the dominate contribution at the receiver. If the value of a does significantly impact the
 266 results, then the range of the variables should be increased. However, the value of a can be
 267 better approximated by considering how quickly the correlation between nearby points in
 268 the dataset deteriorates as a function of distance.

269 III. VALIDATION

270 The first step to validate the hybrid method is to choose a complex object and to
 271 calculate its associated table of corrections. Since a T-shaped barrier has been widely
 272 studied^{6,10,11,30,31}, the complex object is a T-barrier that is 3 m tall and 0.2 m thick with
 273 a 1 m wide top, and the simplified object is an I-barrier that is 3 m tall and 0.2 m thick
 274 (Figure 4). Since the barriers are modeled in 2.5D, they have a constant cross-section and
 275 infinite length. The surround scene is flat, hard ground, and the medium is air where the
 276 sound speed is $c = 340$ m/s, the density is $\rho = 1.3$ kg/m³, and the reference pressure is
 277 $p_{\text{ref}} = 20$ μ Pa. The frequencies are the 50 Hz–5 kHz third-octave bands.

278 The source position is $x_s = -3.0$ m and $z_s = 0.3$ m, and the receiver height is $z_r = 1.5$ m.
 279 Each of these variables only need one value because all of the following examples only
 280 one source position and one receiver height. In practice, the source/receiver positions are
 281 unknown, so to compensate the total number of locations for x_r and Δy is limited to only
 282 20^2 , which would be similar to using 20^5 locations if all five of the position variables were
 283 unknown. Each location also has about twenty frequencies, which would bring the total to
 284 the 20^6 points that is mentioned in Section II A. Since x_r and Δy require many values, for

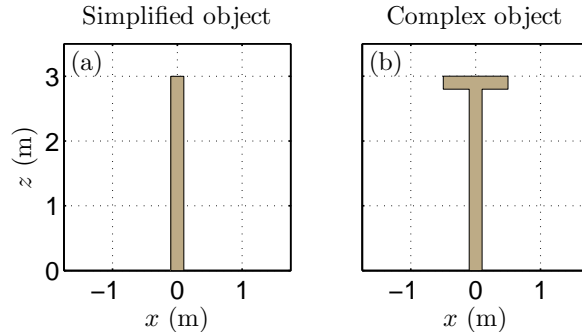

FIG. 4. (Color online) The cross-sections of (a) the simplified I-barrier and (b) the complex T-barrier.

simplicity the following exponential equation gives their values:

$$x_n = e^{\frac{\ln(x_{N-1}-x_0+1)}{N-1}n} + x_0 - 1, \quad (13)$$

where N is the number of points, n is the index such that $0 \leq n \leq N - 1$, and x_0 and x_{N-1} are the smallest and large values along a dimension. The range of x_r is 1 m to 200 m and of Δy is 0 m to 60 m. Making the number of points along each dimension proportional to its range and keeping the total number of points less than 400 yields 36 points for x_r and 11 points for Δy . Thus, evaluating Equation (13) at $(x_0, x_{N-1}, N) = (1, 200, 36)$ for x_r and at $(x_0, x_{N-1}, N) = (0, 60, 11)$ for Δy gives the receiver locations.

A. Hard ground test case

The first test case is a T-barrier with hard ground. It is designed to measure two sources of error: 1) the error between the engineering method and the 2.5D boundary element method for an I-barrier and 2) the interpolation error from interpolating the table of corrections.

296 Thus, the scene should be identical to the scene that is used to calculate the table of
297 corrections.

298 The first test case is the infinite I-barrier or T-barrier in Figure 4 along the y -axis with
299 hard ground at $z = 0$ m. The source is a monopole at $(x, y, z) = (-3, 17.5, 0.3)$ m, and
300 the receivers are on a uniform grid at $x = [0.00, 0.25, \dots, 25.00]$ m, $y = [0.00, 0.25, \dots, 35.00]$ m,
301 and $z = 1.5$ m. The frequencies are the 50 Hz–5 kHz third-octave bands. To combine
302 the frequencies, they are A-weighted and weighted using the combined spectrum of the
303 engine and rolling noise of a car traveling at 80 km/hr, which the Hosanna project (see
304 Tables 9 and 10 in Task 2.3)³⁶ provides. The medium is air, and the engineering method is
305 Harmonoise with up to 6 reflections, 2 lateral diffractions, and a 1 km path length. However,
306 lateral diffraction around the barrier is turned off. In addition to the hybrid method, the
307 2.5D boundary element method (BEM) also produces comparison reference results. The
308 2.5D boundary element method calculates both the table of corrections, which has 396
309 source/receiver pairs, and the reference results, which has 14,241 source/receiver pairs.

310 Figure 5 illustrates the results. The 2.5D boundary element method produces the top
311 plots and the hybrid method produces the bottom plots. The left-hand plots are for the
312 I-barrier and the right-hand plots are for the T-barrier. The hybrid method for the I-barrier
313 is just the engineering method because the extra attenuation is always zero.

314 Contrasting the I-barrier plots demonstrates two main differences between 2.5D BEM and
315 the engineering method. First, at $x = 20$ m plot (a) shows a region of increased levels that
316 is not represented in plot (c). Considering the third-octave results, which are not shown,
317 indicates that BEM is predicting a strong ground effect at 1.6 kHz that the approximation

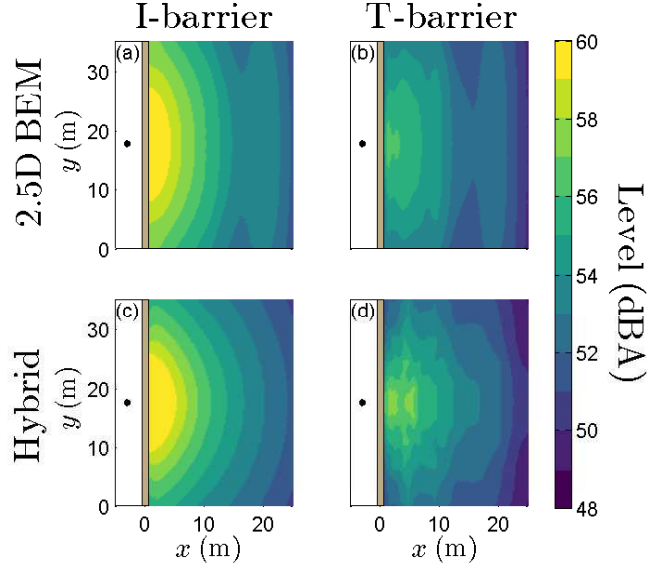

FIG. 5. (Color online) I-barrier (left) or T-barrier (right) with hard ground using 2.5D BEM (top) or the hybrid method (bottom).

318 in the engineering method does not capture. Second, the source appears to be spread in the
 319 y -direction in plot (a) but not in plot (c). This spreading occurs because of the diffraction
 320 over the top edge of the barrier. However, again the engineering method does not predict
 321 this spreading and is more circular because, for simplicity, it assumes that the barrier is
 322 perpendicular to the propagation path regardless of the incidence angle. Contrasting the
 323 T-barrier plots shows similar differences, which carry over from the I-barrier case.

324 The principal result in Figure 5 is that the hybrid method [plot (d)] does better than the
 325 engineering method [plot (c)] at predicting the levels of the T-barrier [plot (b)]. To make
 326 this statement quantitative, the error is defined to be

$$E = L_{\text{model}} - L_{\text{reference}} \quad , \quad (14)$$

327 where L_{model} is the modeled level and $L_{\text{reference}}$ is the reference level. The modeled level comes
 328 from the engineering method [plot (c)] or the hybrid method [plot (d)], and the reference
 329 level comes from 2.5D BEM for the I-barrier [plot (a)] or the T-barrier [plot (b)]. Table I
 330 gives the mean μ , standard deviation σ , and root mean squared (RMS) value of the error
 331 using the receivers in the range $2 \text{ m} \leq x \leq 25 \text{ m}$.

TABLE I. Error for the hard ground case. Here, μ is the mean error, σ is the standard deviation, and RMS is the root mean squared error. All of the values are in dBA.

Method	Barrier	μ	σ	RMS
Harmonoise	I	-0.28	0.55	0.62
Harmonoise	T	1.65	0.97	1.92
Hybrid	T	-0.10	0.68	0.69

332 In Table I, the RMS error for the I-barrier using Harmonoise is 0.62 dBA, but it triples
 333 (1.92 dBA) for the T-barrier because the T-top is neglected in the model. This increased
 334 error is the impetus for developing the hybrid method, which reduces the RMS error to
 335 approximately the level for the I-barrier (0.69 dBA). Moreover, the hybrid method reduces
 336 the standard deviation for the T-barrier from 0.97 dBA to 0.68 dBA. Without interpolation
 337 error, the mean and standard deviation for the I-barrier using the engineering method would
 338 be the same as for the T-barrier using the hybrid method because the hybrid method does
 339 not remove the errors from the engineering method for the I-barrier. Since they are not equal,
 340 there is a moderate amount of interpolation error, which is smaller than the error between

341 the engineering method and 2.5D BEM for the I-barrier. This interpolation error could be
 342 reduced by increasing the number of points in the table of corrections or by optimizing the
 343 locations of the points.

344 B. Soft ground test case

345 The next case is a T-barrier with soft ground and is designed to test if a table of corrections
 346 that is calculated with hard ground can be used to accurately model soft ground. Specifically,
 347 this case is identical to the previous case except that the entire ground is soft like grass with
 348 a flow resistance of $200 \text{ kPa}\cdot\text{s}/\text{m}^2$. 2.5D BEM approximates the ground impedance using
 349 the Delany-Bazley model³⁷.

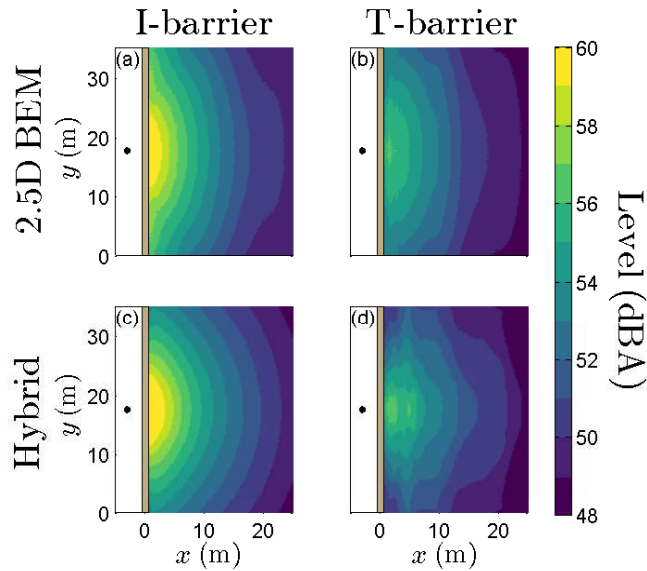

FIG. 6. (Color online) I-barrier (left) or T-barrier (right) with soft ground using 2.5D BEM (top) or the hybrid method (bottom).

350 The results for the soft ground case (Figure 6) are very similar to the results for the
 351 hard ground case (Figure 5). The biggest difference is that the global level is 1-3 dBA lower
 352 for the soft ground case due to the different ground type. Otherwise, the BEM plots still
 353 show a mitigated ground effect at $x = 20$ m, which is absent from the hybrid method plots.
 354 The BEM plots also show the same source spreading, which again is not modeled in the
 355 engineering/hybrid methods.

356 Again, the hybrid method [plot (d)] does a much better job of approximating the levels of
 357 the T-barrier [plot (b)] than the engineering method [plot (c)] does, and Table II quantifies
 358 the improvement. Specifically, when the engineering method is naively applied to the T-
 359 barrier using only an I-barrier, the RMS error (1.47 dBA) more than triples compared to
 360 the I-barrier (0.41 dBA), but using the hybrid method produces a much smaller RMS error
 361 (0.66 dBA).

TABLE II. Error for the soft ground case. Here, μ is the mean error, σ is the standard deviation, and RMS is the root mean squared error. All of the values are in dBA.

Method	Barrier	μ	σ	RMS
Harmonoise	I	-0.02	0.41	0.41
Harmonoise	T	1.31	0.67	1.47
Hybrid-hard	T	-0.16	0.64	0.66
Hybrid-soft	T	0.11	0.55	0.56

362 To directly test the impact of using a different ground type for the table of corrections,
 363 the hybrid method was rerun using a table of corrections that was calculated using soft
 364 ground. These results are not shown in Figure 6 because the pictures are very similar but
 365 are summarized in the last line of Table II. Including the correct ground type decreases the
 366 RMS error from 0.66 dBA to 0.56 dBA. In many cases, this 0.1 dBA decrease is likely not
 367 worth the extra costs (i.e. having to calculate and store many more tables of corrections).
 368 Again, this error is smaller than the error of the standard engineering method compared to
 369 BEM for the I-barrier.

370 Contrasting the results in Tables I and II indicates that the extra attenuation tends to
 371 under correct for hard ground but over correct for soft ground. In detail, for hard ground
 372 the mean error of the hybrid method for the T-barrier is between the mean errors for
 373 the engineering method for the I-barrier and T-barrier (i.e. $-0.28 \text{ dBA} < -0.10 \text{ dBA} <$
 374 1.65 dBA), but for soft ground it is less than both of the other mean errors using the
 375 engineering method (i.e. $-0.16 \text{ dBA} < -0.02 \text{ dBA} < 1.31 \text{ dBA}$). More cases must be
 376 studied to learn if this result is a trend or is case dependent.

377 C. Buildings test case

378 The last test case is a T-barrier with buildings and is designed to evaluate the reflection,
 379 lateral diffraction, and multiple diffraction approximations of the hybrid method. This case
 380 augments the hard ground case, so most of the parameters are the same. The most important
 381 change is the two buildings. Figure 7 illustrates the building dimensions and locations, and
 382 Table III gives the positions of the corners of the buildings. All of the building surfaces are

383 hard, and lateral diffractions are allowed around the buildings. Two additional changes are
 384 that the barrier is now only 35 m long and that the frequency range is only 50 Hz–1.6 kHz.
 385 These changes are necessary to use a fully 3D reference model.

386 The last important change is the reference method for calculating the reference results
 387 (note that the table of corrections is still computed with 2.5D BEM). This case is truly 3D
 388 so the reference method must be 3D. However, 3D BEM can only reach up to about 400 Hz
 389 for this scene. Instead, fast-multipole BEM (FM-BEM)^{38–40} provides the reference levels up
 390 to 1.6 kHz. FM-BEM is significantly faster than conventional BEM [i.e. $O(n \log n)$ versus
 391 $O(n^3)$] because it 1) makes the matrix sparse by putting the boundary contributions into
 392 a hierarchy, 2) uses an iterative solver, and 3) does not store the entire matrix equation.
 393 The FM-BEM implementation was developed at LMSSC/CNAM and was verified using 3D
 394 BEM for this geometry up to 400 Hz.

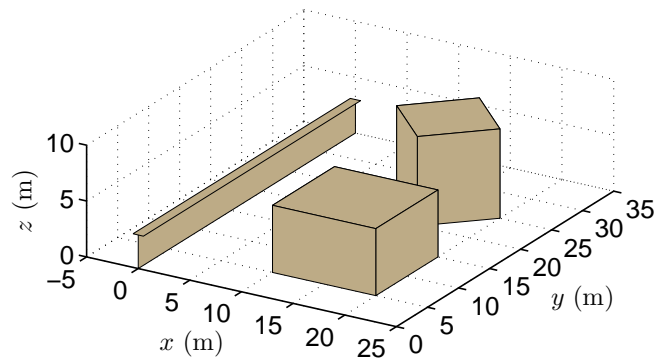

FIG. 7. (Color online) Scene geometry. All surfaces are hard, and the buildings are 6 m and 8 m tall.

395 For the I-barrier (Figure 8), Harmonoise and FM-BEM predict similar levels between
 396 the barrier and the buildings but very different levels behind the buildings (i.e. Harmonoise

TABLE III. Geometry of the buildings. The variables x , y , and z are all in meters.

Corner	<u>Building 1</u>			<u>Building 2</u>		
	x	y	z	x	y	z
1	10	5	6	15	20	8
2	20	5	6	20	25	8
3	20	15	6	15	30	8
4	10	15	6	10	25	8

397 predicts much lower levels behind the buildings). The larger error in these regions is expected
398 because all of the propagation paths to these receivers are diffracted over or around multiple
399 edges and the engineering methods use simple approximations for multiple diffraction. These
400 differences for the I-barrier also affect the predictions for the T-barrier so that the hybrid
401 method does well between the barrier and the buildings and less so behind the buildings.
402 In practice, the sources are usually incoherent line sources instead of a point source, which
403 decreases the size of this region. Furthermore, the priority is often on accurately predicting
404 the highest levels instead of the lowest levels because they have a greater negative impact
405 on people's well-being.

406 Since the results are very different in front of and behind the buildings, Table IV provides
407 a statistical summary in front of the buildings (i.e. where $2 \leq x \leq 8$ and $2 \leq y \leq 33$) and
408 Table V provides it behind the buildings (i.e. where $22 \leq x \leq 25$ and $2 \leq y \leq 33$). These

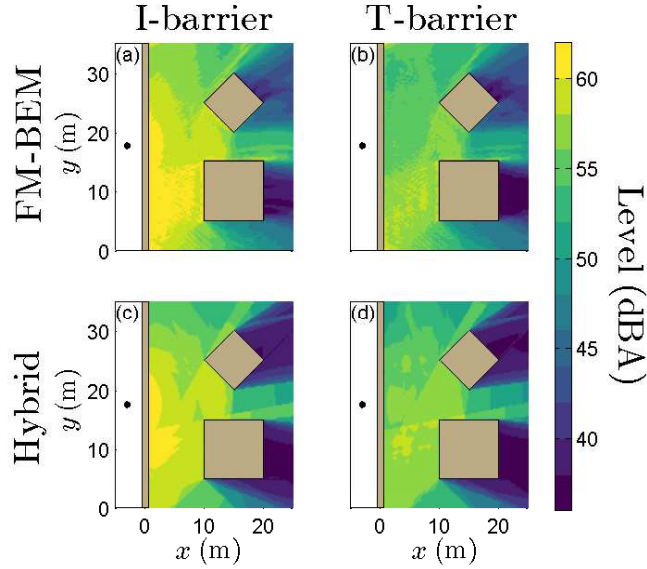

FIG. 8. (Color online) I-barrier (left) or T-barrier (right) with two buildings using FM-BEM (top) or the hybrid method (bottom).

409 tables demonstrate larger RMS error behind the buildings than in front of them for all of
 410 the methods.

TABLE IV. Error for the buildings case in front of the buildings. Here, μ is the mean error, σ is the standard deviation, and RMS is the root mean squared error. All of the values are in dBA.

Method	Barrier	μ	σ	RMS
Harmonoise	I	-0.70	0.60	0.92
Harmonoise	T	2.54	1.07	2.75
Hybrid	T	0.25	0.82	0.85

411 Table IV shows very similar results to Tables I and II. First, the RMS error is similar be-
 412 tween the I-barrier using Harmonoise (0.92 dBA) and the T-barrier using the hybrid method
 413 (0.85 dBA) but much larger for the T-barrier using Harmonoise (2.75 dBA). In addition,
 414 the standard deviation increases slightly going from the I-barrier with Harmonoise to the
 415 T-barrier with the hybrid method (i.e. from 0.60 dBA to 0.82 dBA). A small part of this in-
 416 crease is due to the interpolation error and the differences between 2.5D BEM and FM-BEM
 417 at the points in the table of corrections. The majority increase in the standard deviation
 418 is likely due to the reflection approximation because it ignores the phase information. For
 419 comparison, this increase is about the same size as the increase in the standard deviation
 420 due to using a table of corrections that is calculated with a different kind of ground (i.e.
 421 0.41 dBA to 0.64 dBA in Table II).

TABLE V. Error for the buildings case behind the buildings. Here, μ is the mean error, σ is the standard deviation, and RMS is the root mean squared error. All of the values are in dBA.

Method	Barrier	μ	σ	RMS
Harmonoise	I	-3.2	2.5	4.1
Harmonoise	T	-1.5	3.0	3.3
Hybrid	T	-2.2	2.8	3.6

422 However, Table V is very different because the mean error of the engineering method is
 423 -3.2 dBA. This case demonstrates that the engineering method is less accurate for cases with
 424 multiple diffraction. Furthermore, since the T-barrier does not have the largest path length

425 difference, the error in the engineering method is larger than the T-top correction. This
426 observation justifies the modeling choice of not calculating a correction when the complex
427 object does not have the largest path length difference. Moreover, the RMS error is actually
428 lower modeling the T-barrier with Harmonoise instead of the hybrid method because 1) the
429 mean error for the I-barrier is negative, 2) the extra attenuation is also negative, and 3) the
430 absolute value of the mean error for the I-barrier is larger than the absolute value of the
431 mean extra attenuation. In contrast, one trend that continues from the previous tables is
432 that the standard deviation is smallest for the I-barrier, slightly larger for the T-barrier using
433 the hybrid method, and the largest for the T-barrier using Harmonoise. This result suggest
434 that the hybrid method would do better than Harmonoise for the T-barrier if Harmonoise
435 modeled the I-barrier more accurately. Nonetheless, these multiple diffraction or lateral
436 diffraction paths are not usually the largest contributor to the level when the source is one
437 or more incoherent line sources.

438 **IV. CONCLUSION**

439 This paper develops and validates a hybrid approach to model complex geometries in
440 large urban settings by combining a standard noise engineering method with 2.5D BEM.
441 BEM provides a table of corrections that quantifies the impact of a complex object compared
442 to a simplified object in a very simple surrounding (i.e. usually hard flat ground). For each
443 propagation path and as required, the engineering method linearly interpolates this dataset
444 based on the geometry of the propagation path to obtain the extra attenuation associated
445 with the complex object.

446 The hybrid method is used to model a T-barrier with hard ground, soft ground, and
447 buildings. All of these cases demonstrate that the hybrid method has better accuracy than
448 the standard engineering methods and is far more computationally efficient than full 3D
449 reference methods. Indeed, the hybrid method is computationally efficient enough to be
450 applied whenever the standard engineering methods can be used. The domain size of the
451 validation cases is not limited by the capabilities of the hybrid method but rather of the
452 reference method.

453 Since the hybrid method has many potential sources of error, it has many opportunities
454 for improvement. First, the predictions of the standard engineering methods do not per-
455 fectly match the predictions of reference methods, and any improvement to the engineering
456 methods would also improve the hybrid method. Second, the hybrid method also has some
457 moderate interpolation error. Since the validation section only used 396 source/receiver
458 points, the best way to decrease the interpolation error is to increase the number of points
459 in the table of corrections. However, the total number of points is limited by the avail-
460 able computer memory, so eventually the positions could also be optimized to reduce the
461 interpolation error. Third, many of the approximations (e.g. the multiple and lateral diffrac-
462 tion) are very simple because there are larger errors elsewhere. If the error of the underline
463 engineering method is decreased, then these approximations should be revised.

464 **ACKNOWLEDGMENTS**

465 This research was supported by the Centre Scientifique et Technique du Bâtiment
466 (CSTB).

467 **REFERENCES**

- 468 ¹L. Fritschi, A. L. Brown, R. Kim, D. Schwela, and S. Kephelopoulos, “Burden of
469 disease from environmental noise: quantification of healthy life years lost in Europe,”
470 World Health Organization Regional Office for Europe (2011), [www.euro.who.int/
471 en/publications/abstracts/burden-of-disease-from-environmental-noise-
472 -quantification-of-healthy-life-years-lost-in-europe](http://www.euro.who.int/en/publications/abstracts/burden-of-disease-from-environmental-noise-quantification-of-healthy-life-years-lost-in-europe).
- 473 ²“Directive 2002/49/EC of the European parliament and the council of 25 June 2002 relat-
474 ing to the assessment and management of environmental noise,” (2002), [eur-lex.europa.
475 eu/legal-content/EN/TXT/?uri=CELEX:32002L0049](http://eur-lex.europa.eu/legal-content/EN/TXT/?uri=CELEX:32002L0049).
- 476 ³S. Kephelopoulos, M. Paviotti, and F. Anfosso-Lédée, “Common noise assessment methods
477 in Europe (CNOSSOS-EU),” European Commission Joint Research Centre (JRC) (2012),
478 doi: [10.2788/31776](https://doi.org/10.2788/31776).
- 479 ⁴L. L. Thompson, “A review of finite-element methods for time-harmonic acoustics,” *J.*
480 *Acoust. Soc. Am.* **119**(3), 1315–1330 (2006) doi: [10.1121/1.2164987](https://doi.org/10.1121/1.2164987).
- 481 ⁵I. Harari, “A survey of finite element methods for time-harmonic acoustics,” *Comput.*
482 *Methods Appl. Mech. Eng.* **195**(13-16), 1594–1607 (2006) doi: [10.1016/j.cma.2005.05.
483 030](https://doi.org/10.1016/j.cma.2005.05.030).
- 484 ⁶D. C. Hothersall, S. N. Chandler-Wilde, and M. N. Hajmirzae, “Efficiency of single noise
485 barriers,” *J. Sound Vib.* **146**(2), 303–322 (1991) doi: [10.1016/0022-460X\(91\)90765-C](https://doi.org/10.1016/0022-460X(91)90765-C).
- 486 ⁷M. Baulac, J. Defrance, P. Jean, and F. Minard, “Efficiency of noise protections in
487 urban areas: predictions and scale model measurements,” *Acta Acust. united with*

488 Acust. **92**(4), 530–539 (2006) [www.ingentaconnect.com/contentone/dav/aaua/2006/](http://www.ingentaconnect.com/contentone/dav/aaua/2006/00000092/00000004/art00004)
489 [00000092/00000004/art00004](http://www.ingentaconnect.com/contentone/dav/aaua/2006/00000092/00000004/art00004).

490 ⁸T. Van Renterghem, “Efficient outdoor sound propagation modeling with the finite-
491 difference time-domain (FDTD) method: a review,” *Int. J. Aeroacoustics* **13**(5-6), 385–404
492 (2014) doi: [10.1260/1475-472X.13.5-6.385](https://doi.org/10.1260/1475-472X.13.5-6.385).

493 ⁹R. Mehra, N. Raghuvanshi, A. Chandak, D. G. Albert, D. K. Wilson, and D. Manocha,
494 “Acoustic pulse propagation in an urban environment using a three-dimensional numerical
495 simulation,” *J. Acoust. Soc. Am.* **135**(6), 3231–3242 (2014) doi: [10.1121/1.4874495](https://doi.org/10.1121/1.4874495).

496 ¹⁰P. Jean, “A variational approach for the study of outdoor sound propagation and applica-
497 tion to railway noise,” *J. Sound Vib.* **212**(2), 275–294 (1998) doi: [10.1006/jsvi.1997.](https://doi.org/10.1006/jsvi.1997.1407)
498 [1407](https://doi.org/10.1006/jsvi.1997.1407).

499 ¹¹T. Ishizuka and K. Fujiwara, “Performance of noise barriers with various edge shapes and
500 acoustical conditions,” *Appl. Acoust.* **65**(2), 125–141 (2004) doi: [10.1016/j.apacoust.](https://doi.org/10.1016/j.apacoust.2003.08.006)
501 [2003.08.006](https://doi.org/10.1016/j.apacoust.2003.08.006).

502 ¹²M. Baulac, J. Defrance, and P. Jean, “Optimisation with genetic algorithm of the acoustic
503 performance of T-shaped noise barriers with a reactive top surface,” *Appl. Acoust.* **69**(4),
504 332–342 (2008) doi: [10.1016/j.apacoust.2006.11.002](https://doi.org/10.1016/j.apacoust.2006.11.002).

505 ¹³A. Jolibois, D. Duhamel, V. W. Sparrow, J. Defrance, and P. Jean, “Sensitivity-based
506 shape optimization of a rigid tramway low-height noise barrier,” in *Inter-noise Proc.*,
507 Innsbruck, Austria (2013), pp. 3492–3501, [www.ingentaconnect.com/contentone/ince/](http://www.ingentaconnect.com/contentone/ince/incecp/2013/00000247/00000004/art00013)
508 [incecp/2013/00000247/00000004/art00013](http://www.ingentaconnect.com/contentone/ince/incecp/2013/00000247/00000004/art00013).

509 ¹⁴“ISO 9613-2:1996 Acoustics - attenuation of sound during propagation outdoors - part
510 2: general method of calculation,” International Organization for Standardization (ISO)
511 (1996), www.iso.org/standard/20649.html.

512 ¹⁵D. van Maercke and J. Defrance, “Development of an analytical model for out-
513 door sound propagation within the Harmonoise project,” Acta Acust. united with
514 Acust. **93**(2), 201–212 (2007) [www.ingentaconnect.com/contentone/dav/aaua/2007/
515 00000093/00000002/art00004](http://www.ingentaconnect.com/contentone/dav/aaua/2007/00000093/00000002/art00004).

516 ¹⁶E. Salomons, D. van Maercke, J. Defrance, and F. de Roo, “The Harmonoise sound prop-
517 agation model,” Acta Acust. united with Acust. **97**(1), 62–74 (2011) doi: [10.3813/AAA.
518 918387](https://doi.org/10.3813/AAA.918387).

519 ¹⁷D. P. Hewett, “High frequency sound propagation in a network of interconnecting streets,”
520 J. Sound Vib. **331**(25), 5537–5561 (2012) doi: [10.1016/j.jsv.2012.07.030](https://doi.org/10.1016/j.jsv.2012.07.030).

521 ¹⁸A. Muradali and K. R. Fyfe, “Accurate barrier modeling in the presence of atmospheric
522 effects,” Appl. Acoust. **56**(3), 157–182 (1999) doi: [10.1016/S0003-682X\(98\)00023-1](https://doi.org/10.1016/S0003-682X(98)00023-1).

523 ¹⁹A. Farina, “Validation of the pyramid tracing algorithm for sound propagation outdoors:
524 comparison with experimental measurements and with the ISO-DIS 9613 standards,” Adv.
525 Eng. Softw. **31**(4), 241–250 (2000) doi: [10.1016/S0965-9978\(99\)00053-8](https://doi.org/10.1016/S0965-9978(99)00053-8).

526 ²⁰H. Wang, Z. Yu, and M. Cai, “The 3D attenuation calculation of traffic noise among
527 building groups by using beam tracing method,” Procedia - Soc. Behav. Sci. **96**, 1929–
528 1937 (2013) doi: [10.1016/j.sbspro.2013.08.218](https://doi.org/10.1016/j.sbspro.2013.08.218).

529 ²¹D. Lee, A. D. Pierce, and E. Shang, “Parabolic equation development in the twentieth
530 century,” *J. Comput. Acoust.* **8**(4), 527–637 (2000) doi: [10.1142/S0218396X00000388](https://doi.org/10.1142/S0218396X00000388).

531 ²²T. Van Renterghem, D. Botteldooren, and P. Lercher, “Comparison of measurements
532 and predictions of sound propagation in a valley-slope configuration in an inhomogeneous
533 atmosphere,” *J. Acoust. Soc. Am.* **121**(5), 2522–2533 (2007) doi: [10.1121/1.2717765](https://doi.org/10.1121/1.2717765).

534 ²³F. Aballéa and J. Defrance, “Single and multiple reflections in plane obstacle using
535 the parabolic equation method with a complementary Kirchhoff approximation,” *Acta*
536 *Acust. united with Acust.* **93**(1), 22–30 (2007) [www.ingentaconnect.com/contentone/
537 dav/aaua/2007/00000093/00000001/art00003](http://www.ingentaconnect.com/contentone/dav/aaua/2007/00000093/00000001/art00003).

538 ²⁴T. Van Renterghem, E. M. Salomons, and D. Botteldooren, “Efficient FDTD-PE Model for
539 sound propagation in situations with complex obstacles and wind profiles,” *Acta Acust.*
540 *united with Acust.* **91**(4), 671–679 (2005) [www.ingentaconnect.com/contentone/dav/
541 aaua/2005/00000091/00000004/art00006](http://www.ingentaconnect.com/contentone/dav/aaua/2005/00000091/00000004/art00006).

542 ²⁵J. Defrance, E. Salomons, I. Noordhoek, D. Heimann, B. Plovsing, G. Watts, H. Jonasson,
543 X. Zhang, E. Premat, I. Schmich, F. Aballea, M. Baulac, and F. de Roo, “Outdoor sound
544 propagation reference model developed in the European Harmonoise project,” *Acta Acust.*
545 *united with Acust.* **93**(2), 213–227 (2007) [www.ingentaconnect.com/contentone/dav/
546 aaua/2007/00000093/00000002/art00005](http://www.ingentaconnect.com/contentone/dav/aaua/2007/00000093/00000002/art00005).

547 ²⁶P. Jean, “Coupling integral and geometrical representations for vibro-acoustical problems,”
548 *J. Sound Vib.* **224**(3), 475–487 (1999) doi: [10.1006/jsvi.1999.2195](https://doi.org/10.1006/jsvi.1999.2195).

- 549 ²⁷P. Jean, “Coupling geometrical and integral methods for indoor and outdoor sound propa-
550 gation - validation examples,” *Acta Acust. united with Acust.* **87**(2), 236–246 (2001) www.ingentaconnect.com/contentone/dav/aaua/2001/00000087/00000002/art00010.
- 552 ²⁸S. Hampel, S. Langer, and A. Cisilino, “Coupling boundary elements to a raytracing
553 procedure,” *Int. J. Numer. Methods Eng.* **73**(3), 427–445 (2008) doi: [10.1002/nme.2080](https://doi.org/10.1002/nme.2080).
- 554 ²⁹H. Yeh, R. Mehra, Z. Ren, L. Antani, D. Manocha, and M. Lin, “Wave-ray coupling
555 for interactive sound propagation in large complex scenes,” *ACM Trans. Graph.* **32**(6),
556 165:1–11 (2013) doi: [10.1145/2508363.2508420](https://doi.org/10.1145/2508363.2508420).
- 557 ³⁰J. Defrance and P. Jean, “Integration of the efficiency of noise barrier caps in a 3D ray
558 tracing method. case of a T-shaped diffracting device,” *Appl. Acoust.* **64**(8), 765–780
559 (2003) doi: [10.1016/S0003-682X\(03\)00034-3](https://doi.org/10.1016/S0003-682X(03)00034-3).
- 560 ³¹C. H. Kasess, W. Kreuzer, and H. Waubke, “Deriving correction functions to model the
561 efficiency of noise barriers with complex shapes using boundary element simulations,”
562 *Appl. Acoust.* **102**, 88–99 (2016) doi: [10.1016/j.apacoust.2015.09.009](https://doi.org/10.1016/j.apacoust.2015.09.009).
- 563 ³²B. Plovsing, “Nord2000. Comprehensive outdoor sound propagation model. part 1: prop-
564 agation in an atmosphere without significant refraction,” Danish Electronics, Light, and
565 Acoustics (DELTA) (2006), dk.madebydelta.com/viden/publikationer/.
- 566 ³³D. van Maercke, T. Leissing, and J. Maillard, “Task 6.2: Evaluation of innovative and com-
567 bined mitigations,” Holistic and sustainable abatement of noise by optimized combinations
568 of natural and artificial means (HOSANNA) (2013), www.greener-cities.eu/.

- 569 ³⁴D. Duhamel, “Efficient calculation of the three-dimensional sound pressure field around a
570 noise barrier,” *J. Sound Vib.* **197**(5), 547–571 (1996) [http://www.sciencedirect.com/
571 science/article/pii/S0022460X96905489](http://www.sciencedirect.com/science/article/pii/S0022460X96905489) doi: [10.1006/jsvi.1996.0548](https://doi.org/10.1006/jsvi.1996.0548).
- 572 ³⁵P. Jean, J. Defrance, and Y. Gabillet, “The importance of source type on the assessment
573 of noise barriers,” *J. Sound Vib.* **226**(2), 201–216 (1999) [http://www.sciencedirect.
574 com/science/article/pii/S0022460X99922733](http://www.sciencedirect.com/science/article/pii/S0022460X99922733) doi: [10.1006/jsvi.1999.2273](https://doi.org/10.1006/jsvi.1999.2273).
- 575 ³⁶J. Defrance, P. Jean, F. Koussa, A. Khan, K. Horoshenkov, H. Benkreira, T. Van
576 Renterghem, J. Kang, J. Smyrnova, and J. Forssén, “Task 2.3: Application to innova-
577 tions,” *Holistic and sustainable abatement of noise by optimized combinations of natural
578 and artificial means (HOSANNA)* (2013), www.greener-cities.eu/.
- 579 ³⁷M. Delany and E. Bazley, “Acoustical properties of fibrous absorbent materials,” *Appl.*
580 *Acoust.* **3**(2), 105–116 (1970) doi: [10.1016/0003-682X\(70\)90031-9](https://doi.org/10.1016/0003-682X(70)90031-9).
- 581 ³⁸T. Sakuma and Y. Yasuda, “Fast multipole boundary element method for large-scale
582 steady-state sound field analysis. part I : setup and validation,” *Acta Acust. united with
583 Acust.* **88**(4), 513–525 (2002) [www.ingentaconnect.com/contentone/dav/aaua/2002/
584 00000088/00000004/art00007](http://www.ingentaconnect.com/contentone/dav/aaua/2002/00000088/00000004/art00007).
- 585 ³⁹X. Vuylsteke, “Development of a reference method based on the fast multipole bound-
586 ary element method for sound propagation problems in urban environments: formal-
587 ism, optimizations & applications,” *Doctoral dissertation, Université Paris-Est, 2014,*
588 tel.archives-ouvertes.fr/tel-01167130/document.

589 ⁴⁰N. A. Gumerov and R. Duraiswami, *Fast multipole methods for the Helmholtz equation in*
590 *three dimensions* (Elsevier, 2004), pp. 1–520, [www.sciencedirect.com/science/book/](http://www.sciencedirect.com/science/book/9780080443713)
591 [9780080443713](http://www.sciencedirect.com/science/book/9780080443713).