



HAL
open science

Evaluate the influence of starch on earth/hemp or flax straws mixtures properties in presence of superplasticizer

Ghaith Alhaik, Vincent Dubois, Eric Wirquin, Alexandre Leblanc, Georges Aouad

► To cite this version:

Ghaith Alhaik, Vincent Dubois, Eric Wirquin, Alexandre Leblanc, Georges Aouad. Evaluate the influence of starch on earth/hemp or flax straws mixtures properties in presence of superplasticizer. *Construction and Building Materials*, 2018, 186, pp.762-772. 10.1016/j.conbuildmat.2018.07.209 . hal-03285015

HAL Id: hal-03285015

<https://hal.science/hal-03285015v1>

Submitted on 13 Jul 2021

HAL is a multi-disciplinary open access archive for the deposit and dissemination of scientific research documents, whether they are published or not. The documents may come from teaching and research institutions in France or abroad, or from public or private research centers.

L'archive ouverte pluridisciplinaire **HAL**, est destinée au dépôt et à la diffusion de documents scientifiques de niveau recherche, publiés ou non, émanant des établissements d'enseignement et de recherche français ou étrangers, des laboratoires publics ou privés.

Evaluate the influence of starch on earth/hemp or flax straws mixtures properties in presence of superplasticizer

Ghaith Alhaik^{a,*}, Vincent Dubois^b, Eric Wirquin^b, Alexandre Leblanc^b,
Georges Aouad^c

^aUniversity of Cergy-Pontoise, 5 Mail Gay Lussac, 95031 Neuville-sur-Oise, France

^bUniv. Artois, EA 4515, Laboratoire de Génie Civil et géo-Environnement (LGCgE),
F-62400 Béthune, France

^cFaculty of Engineering, University Of Balamand, UOB, Al Koura, Lebanon

Abstract

In this paper, we study the influence of two types of starch on earth hemp or flax straw mixtures at fresh and hardened states. The main goal is to propose new non-load bearing earthen for indoor. The mass percentage of starch/binder (S/B) in mixtures was fixed at 1% of mass. The VEBE consistometer test has been used to fix a similar consistency between mixtures. The targeted workability has to allow an easy introduction of materials in the moulds. Adding both of starch has shown a positive effect on mixtures workability at the fresh state and mechanical resistances at the hardened state. At hardened state, mechanical and thermal-acoustic performances have been measured on laboratory samples and blocks at real scale. Results have shown a significant effect of starch on mechanical strengths.

Keywords: Starch, Earth/straw blocks, Mechanical performances

*Corresponding author: ghaith.alhaik.84@hotmail.com

1. INTRODUCTION

Currently, the return to more ecological values largely favours the renewed interest in sustainable and economical building materials such as Raw Earth Materials (REMs). REMs, used as building materials in a quarter of the world's dwellings and in more than a third of world heritage monuments, represent an interesting solution for ecological problems because it's a local resource and needs a little energy for its implementation. In addition, REMs give to walls properties of comfort in accordance with the criteria requested by the French current thermal regulations RT 2012. Indeed, REMs allow a regulation of the humidity in the rooms. It can also regulate the temperature due to its inertia and thus bring, in particular, summer comfort by phase shift. The hygrothermal regulation capacity and the limitation of energy consumption and greenhouse gas emissions during the manufacture and the implementation of this type of products are major advantages in comparison with existing conventional products. Often associated with straw, a light material is obtained with interesting performances for thermal and acoustic insulation. REMs-straw association represents a way of using the REMs spread geographically for centuries. But ancestral practices are opposed to current industrial practices because of the long time needed to set up and dry these mixes, which must be moistened in order to work with the straw.

Nowadays the objective is to be able to build quickly and well. REMs-straw mixes can be developed and adapted to fit into a conventional distribution circuit where most building materials are purchased. In the past three decades, considerable efforts have been directed towards the use of various plant fibers, which are abundantly available in tropical and subtropical countries, for the production of cost-effective building materials for sustainable development. The earth-straw products must thus meet the constraints of prefabrication and short

storage to be competitive in comparison with concrete or gypsum products. The handling of the material in the fresh state must be easier and the mechanical performance must be improved, while keeping the environmental benefits. Several investigations have been dedicated on the study of earth-straw mixtures to find the best mechanical and thermal properties of products made with unfired earth, stabilized or unstabilized. Dubois et al [1] have studied the association of quarry fines-hemp to be used in the manufacture of precast non-bearing products. Brouard et al [2] have compared two types of vegetable aggregates (rape straw and sunflower) associated with earth in order to study mechanical and hygrothermal behavior of plaster bio-composite. While Degrave-Lemeurs et al [3] have studied and compared acoustical properties of hemp-clay samples with hemp-lime ones. Laborel-Préneron et al have written a review on the use of plant aggregates and fibers in earth construction materials [4]. Other research studies have studied the association of clay-hemp [5], clayey soil-nature fibre [6], clay-straw [7, 8], clay-wheat straw [9, 10, 11]. All these research works showed the benefits by associating the earth with plant aggregates especially to enhance the insulation performances.

Furthermore, with the environmental problems, researchers are focusing on renewable and bio-based resources to reduce the environmental impacts of building materials, which in turn promotes the development of eco-building materials. Thus the civil engineering is today in connection with the field of green chemistry, which develops bio-based additives made of plant origin such as the family of polysaccharides. Several research studies have outlined the benefits of using starch on construction. Starch is a homopolymer from polysaccharides family with 100% vegetable origin. It exists in several vegetables like tubers, cereals and legumes. Starch is composed principally of amylose and amylopectin, in addition of minor percentages of protein, lipids and phosphorus. It could be dif-

55 ferentiated from other polysaccharides because of its amylopectin which has a strong influence on the dispersion and stabilization of particles [12]. A.T. Le et al [13, 14] have replaced, in the composition of hemp concrete, lime by starch to obtain a lighter dry density (between 170.8 and 158.9 kg/m^3), with satisfactory compressive strength (between 0.4 and 0.5 MPa), knowing that for hemp concrete, the average of compressive strength varies from 0.1 to 0.8 MPa for a dry density between 330 and 470 kg/m^3 . They also showed up that starch/hemp cannot be used as a construction material because of their very low Young's modulus (between 1.47 and 2.16 MPa) for these range of densities. Akindehinde et al [15] have studied the influence of two types of starch (maize and cassava) on certain properties of concrete. The results of the mechanical tests up to 180 days of cure showed that both starches have a positive impact on the concrete especially in the short term (up to 28 days): for example, adding 1% of starch by weight of cement gave an increase of 5.3% and 4,9% the compressive strengths with corn and cassava starch, respectively. On the other hand, 70 increasing the percentage of starch from 1% to 1.5% or even 2% has a less important or even negative effect from 28 days of treatment. Other studies show that the addition of starch improves the workability of cement pastes and can be used as a replacement for petrochemical adjuvants reducing water [16].

In previous research work, Alhaik et al [17] showed that starch improves the mechanical strengths of clayey materials. The addition of starch has also increased the thixotropic index up to four times. This study comes as a continuing of previous research work [17], which had shown that starches have a very important effect on the rheological and mechanical properties of earth paste. Therefore, the main goal of the present work is to evaluate the influence of two types of 80 starch on earth/plant mixtures at fresh and hardened states.

2. MATERIALS

In this section, the characteristics of materials used in this work are shown.

2.1. Quarry fines (QF)

Earth materials used in this work are quarry fines furnished by "Carrières
85 du Boulonnais", which is a company located in the north of France. These
quarry fines come as a result of aggregates washed in the quarry to respect
the European standard EN 12620 [18]. The analysis by X-ray diffraction ac-
cording to the European standard EN 13925-2 [19] carried out by the company
"Carrières du Boulonnais" has shown a majority of limestone and clay. There-
90 fore, these materials are defined as Ap (low plastic clay) according to the USCS
classification. Table 1 presents the properties of the quarry fines measured by
Carrières du Boulonnais. Despite a relatively small proportion of clay in these
materials (19%), they present physical behavior of clay. The clay part is com-
posed of kaolinite (12%) and illite (7%), which have low sensitivity to swelling
95 phenomena.

Table 1: Properties of the quarry fines.

Properties	Values
Proctor test	
Optimum moisture content	14 %
Maximum dry density	1860 kg/m^3
Atterberg limits	
Liquid limit LL	33 %
Plastic limit PL	21 %
Plasticity index PI	12 %
Particle size distribution	
Sand (2 - 0.063 mm)	1.5 %
Silt (0.075 - 0.002 mm)	81.3%
Clay (< 0.002 mm)	17.2%
Organic content	2.17 %

The granular distribution of QF performed by the laser diffraction methods

[19] shows that these quarry fines have grain sizes ranging from 0.1 to 100 μm , with dominant sizes (60%) between 0.1 to 20 μm .

2.2. Starch

100 The starch used in this study has grains sizes of 1-100 μm in the form of a white powder. Starches vary in size and shape according to their botanical origins [20]. Based on the results of previous research work [17], two starches (D and H) have been chosen for this study, according to their efficiency to improve both of rheological and mechanical proprieties. The first starch (mentioned D) 105 is a native starch while the other one (mentioned H) is a pregelatinized starch which had been cooked in hot water according to its gelling temperature. During the process of gelatinization, particles of starch lose their semi crystalline structure then they change their viscosity according to their vegetable origin as well as their percentage of amylose and amylopectin. This process is irre- 110 versible and gives a soluble starch (about 98%) in water at ambient temperature. Both of starches were prepared and furnished by Roquette which is a company specialized in the starches production.

2.3. Hemp and flax straws

Two by-products "hemp and flax straws" have been chosen for this study. 115 Their apparent densities, measured in laboratory, are 121.2 kg/m^3 and 105.8 kg/m^3 for hemp and flax straw, respectively. Figure 1 shows the particles observations of hemp and flax straws. The maximum size of hemp or flax straw particles is up to 40 mm . Hemp and flax straws have a high porosity and their porosity induces a large and fast water absorption, with water absorption of 120 130% (mass ratio water/dry straw) one minute after immersion (Fig. 2). All of these measurements have been done according to the recommendation of the RILEM TC 236-BBM [21]. The optical image of both of plant aggregates

presented in figure 1 shows the small diameter of flax particles compared to hemp particles diameter.

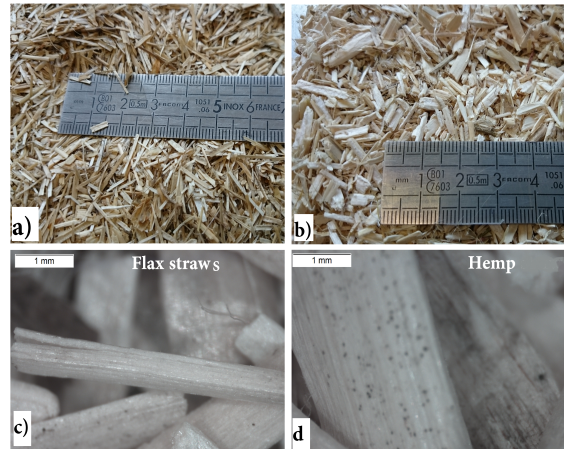

Figure 1: Macro and Micro observations of particles of flax straws(left) and hemp (right).

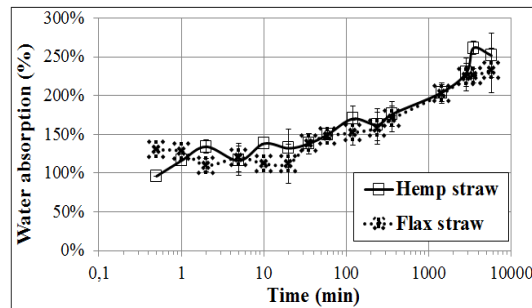

Figure 2: Water absorption of hemp and flax straw.

125 2.4. Superplasticizer (SP)

The superplasticizer Chryso Fluid Premia 205 (SP) has been chosen for this study. This superplasticizer was used by Dubois et al [1] to reduce the water content in QF/hemp mixtures. In this study, the same superplasticizer (dry extract)/binder (SP/B) ratio of 1.3% is chosen. This superplasticizer is furnished at liquid state with a dry extract of 30.3% and a density equal to 1.055.

It is incorporated with water during the mixing. The letters (SP) indicate that mixtures include a superplasticizer.

2.5. Lime (L)

The commercial name of the lime (L) used in this study is AKTA Chaux.
135 It is composed of natural hydraulic lime, natural pozzolans, clinker, limestone fillers and admixtures.

3. METHODOLOGY

3.1. Mixtures parameters

The term binder, in this study corresponds to the mineral part whereas the
140 term of aggregate to hemp or flax straw. Two binder/aggregate ratios (B/A) have been chosen equal to 5.5 or 3.5% and a starch/binder ratio (S/B) equal to 1%, respectively. The water/binder ratio (W/B) has been fixed experimentally to obtain the same workability for all mixtures. In this work, each mixture had been referenced with numbers and letters which correspond to:

- 145 • For the two first numerals to the B/A ratio without decimal point,
- For the two following numerals to the W/B ratio without decimal point,
- For the letter D or H to the type of starch,
- For letters SP to the presence of superplasticizer,
- For the letter L to the presence of lime,
- 150 • For the mixtures with flax straw, the letter F was added at the end. For the others references, hemp straw has been used.

For example, the (5506D) mixture means that B/A ratio is 5.5, W/B ratio is 0.6, the letter D corresponds to type of starch used in this mixture and hemp

straw for vegetal part.

155 The dry density has been fixed to $800 \pm 100 \text{ kg/m}^3$ in order to obtain a maximum mass of block of 20 kg to easily handle the products on building sites. The weight of each component in the mixture have been obtained by equations 1 to 6.

$$\text{Dry density} = \frac{M_{binder} + M_{aggregate} + M_{starch}}{V} \quad (1)$$

$$M_{binder} = M_{QF} + M_{Lime} \quad (2)$$

160

$$M_{starch} = 1\% \times M_{binder} \quad (3)$$

$$\text{Two } B/A \text{ ratio : } \frac{M_{binder}}{M_{aggregate}} = 5.5 \text{ or } 3.5 \quad (4)$$

$$W/B = M_{water}/M_{binder} \quad (5)$$

$$M_{SP} = 1.3\% \times M_{binder} \quad (6)$$

3.2. Mixing procedures

165 A planetary concrete mixer was chosen in this study to prepare the materials. Pregelatinized starch (H) included in some mixtures is cold water-soluble, whereas the native one (D) chosen for this experimental campaign needs hot water for gelatinization. Three mixing procedures have been designed inspired from the EN 196-1 standard [22]: one for the reference mixtures (without starch) and the other two for mixtures (including both of starches D or H).

170

The first procedure for reference mixtures was as the following:

- 1) Put all water in the mixer,
- 2) Add progressively of QF (60 s) then mixing (60 s),
- 3) Add progressively of the hemsps or flax straw (60 s) then mixing(60 s),
- 175 4) Scraping the bowl (30 s - stop) then mixing (30 s).

The second procedure for cold mixtures was as the following:

- 1) Mixing starch H with QF,
- 2) Put all water in the mixer,
- 3) Add progressively of QF/starch H (60 s) then mixing (60 s),
- 180 4) Add progressively of the hemsps or flax straw (60 s) then mixing(60 s),
- 5) Scraping the bowl (30 s - stop) then mixing (30 s).

The third procedure for warm mixtures was as the following:

- 1) Divide the amount of water in two parts (90% hot and 10% cold)
- 2) Mixing cold water+starch D until homogeneity (to obtain starch milk)
- 185 3) Mixing the starch milk with hot water then put the whole in the mixer
- 4) Add progressively of QF (60 s) then mixing (60 s),
- 5) Add progressively of the hemsps or flax straw (60 s) then mixing(60 s),
- 6) Scraping the bowl (30 s - stop) then mixing (30 s).

For mixtures including superplasticizer and/or lime, the superplasticizer was
190 mixed preliminary with the water and the lime was introduced in the same step
with QF.

3.3. Evaluate mixtures consistencies

A VEBE consistometer has been used to evaluate the consistency of mix-
tures according to the standard EN 12350-3 [23]. The VEBE consistometer is
195 usually used to evaluate the concrete consistency with a spreading time between
(5 - 30 s). Based on preliminary tests [1], the spreading time has been adapted

with these mixtures.

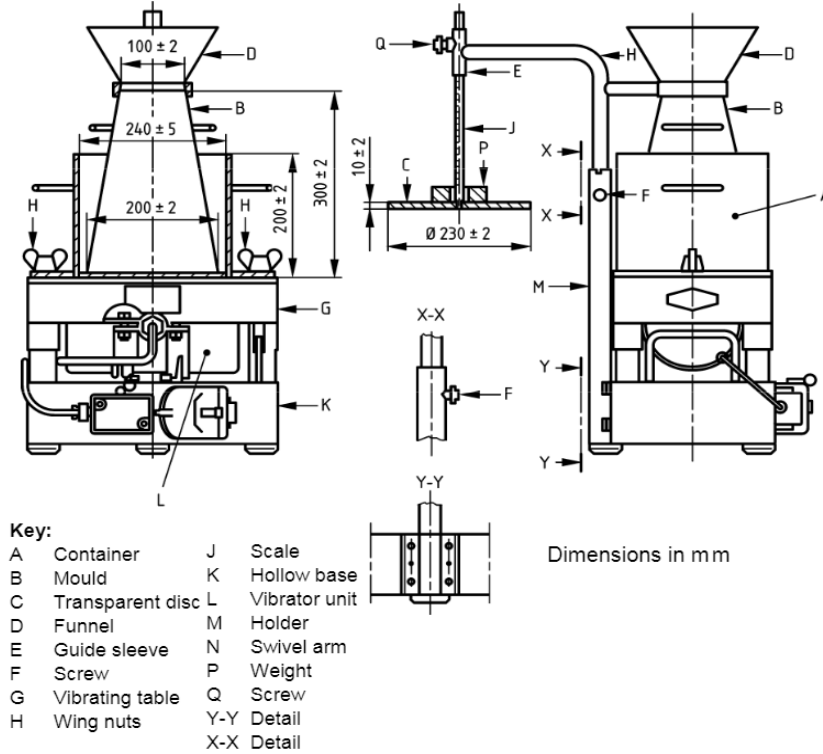

Figure 3: Typical Consistometer (Vebe meter) [23].

As illustrated in the figure 3 the VEBE consistometer is made of a metallic
 200 cylinder ($d = 240\text{mm}$, $h = 200\text{mm}$), a tronconic mold and a transparent hori-
 zontal disc ($d = 230\text{mm}$) fixed on a metal graduated ruler. All these elements
 are placed on a vibrating table which produces 3000 vibrations per minute that
 cause movements with vertical amplitude about 0.5 mm. The tronconic mold
 is filled with the material in three layers. Each layer is tamped 25 times with
 205 a metal rod measuring ($l = 600\text{mm}$, $\phi = 16\text{mm}$). Then the mold is pulled and
 the transparent disc is placed on the top of the material. The vibrating table is
 launched at the same time as a chronometer. The vibrations cause the material

to sag and to gradually come into contact with the disc. When the material touches the whole disc, the chronometer is stopped and the time corresponds to
210 the filling time and the sag value is inferred by the graduated ruler.

3.4. Mechanical tests

3.4.1. Casting protocol

The wet mass of matter to fill in the molds is chosen to respect the targeted dry density of 800 kg/m^3 . The small diameter for flax straw particles caused an
215 increase of wet mass of matter to respect the mold dimensions. In addition to the impossibility to ensure a 100% homogeneous implementation. Consequently, two dry density of $800 \pm 100 \text{ kg/m}^3$ and $900 \pm 100 \text{ kg/m}^3$ have been chosen for mixtures with hemp straw and flax straw, respectively. The mixture was put in the mold in two layers, each layer is compacted with 15 uniformly distributed
220 blows from the rammer, then specimens are unmolded and stored, until the mechanical tests are performed, in the laboratory with conditions of 20°C and 50% RH. These conditions are similar to conditions of storage after manufacturing or to inner ambience in a building. A USB data logger (EL-USB-2) had been used to verify the temperature and the humidity in the laboratory room. During the
225 storage period, weight loss and dimensions are measured for all specimens until the mechanical tests. With the same protocol, blocks of $7 \times 50 \times 65 \text{ cm}^3$ have been manufactured with the compositions having the best results in laboratory specimens in order to verify and validate these results. All blocks are immediately demoulded and stored under the same conditions of 20°C and 50% RH for
230 28 days.

3.4.2. Operating mode for mechanical tests

An electromechanical testing machine has been used to measure the mechanical strengths. This machine has a force capacity of 50 kN and ensures a

satisfactory level of precision ($\pm 0.5\%$ between 0 and 0.5 kN and $\pm 0.3\%$ between
 235 0.5 kN and 50 kN) for the non-bearing products. The mechanical tests have
 been done 28 days after manufacturing on the prismatic specimens of $7 \times 7 \times 28$
 cm^3 according to the EN 12390-5 standard [24].

The three-point bending tests are carried out according to the EN 12859
 240 standard [25] in a similar way as the gypsum blocks. The length between bottom
 supports is 566 mm for blocks (Fig.4).

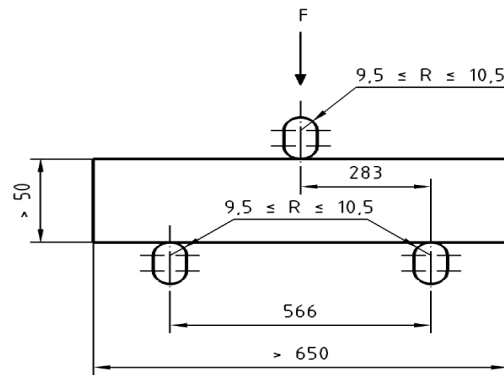

Figure 4: Bending strength testing device for blocks [25].

A constant loading rate of 4 N/sec had been chosen for flexural strengths
 on laboratory samples. For blocks, a constant loading rate of 20 N/sec had
 been chosen for flexural strengths based on french norme recommandations [25].
 245 Whereas, a constant displacement rate of 1 *mm/min* upon 30 N puis 5 *mm/min*
 was applied on the half-blocks obtained after flexural test. This value was chosen
 according to the work of Flament [26] and Cerezo [27].

3.5. Thermal and acoustic characteristics

For thermal measurement, a guarded hot plate with two fluxmeters having a
 250 circular form ($D = 8$ cm) is used. Two parameters have been measured thermal

conductivity (λ) and mass heat capacity (C) according to EN 12667 standard [28]. The sample is placed between two plates. For the thermal conductivity measurement, one plate is at 15°C and the other one at 25°C. For the mass heat transfer, plates are initially at 15°C then the temperature is increased to 25°C. Two prism samples of ($25 \times 25 \times 7 \text{ cm}^3$) per type of product are tested, with similar composition with that of blocks for mechanical tests.

To measure the acoustic measurement, the impedance tube is used according to the EN ISO 10534-1 standard [29]. For this test, two cylindrical samples per formulation have been manufactured ($D = 10 \text{ cm}, h = 7 \text{ cm}$). The test sample is put on one end of a straight impedance tube that is rigid, smooth and airtight. Plane waves are generated in the tube by a sound source and the sound pressures are measured at two locations near the sample. The complex acoustic transfer function of the two microphone signals is determined and used to calculate the normal incidence absorption factor. The thermal and acoustic results are compared with performances of conventional products.

4. RESULTS AND DISCUSSION

4.1. At fresh state

4.1.1. Influence of starch on QF/hemp or flax straw mixtures consistency

Several mixtures have been tested (Tab. 2) in order to determinate the influence of water content as well as the influence of starch on QF/hemp or flax straw consistency. Results presented on figure 5 show that:

Table 2: Studied mixtures.

With hemp	5506	5507	5508	5509D	5510D	5509H	5510H
With flax	5506-F	5507-F	5508-F	5509D-F	5510D-F	5509H-F	5510H-F

- In QF/hemp mixtures, increase the W/B ratio from 0.6 to 0.7 makes it possible to have a measurable filling time.
- In QF/flax mixtures, W/B ratio has to be increased to 0.8 to obtain a measurable filling time.
- The addition of starch on QF/hemp or flax straw mixtures causes a large increase of W/B ratio for the same consistency which had been confirmed in previous research work conducted in the laboratory [17].

The difference between W/B ratio for QF/hemp or QF/flax mixtures at the same consistency could be linked to the small particles diameter of flax straw.

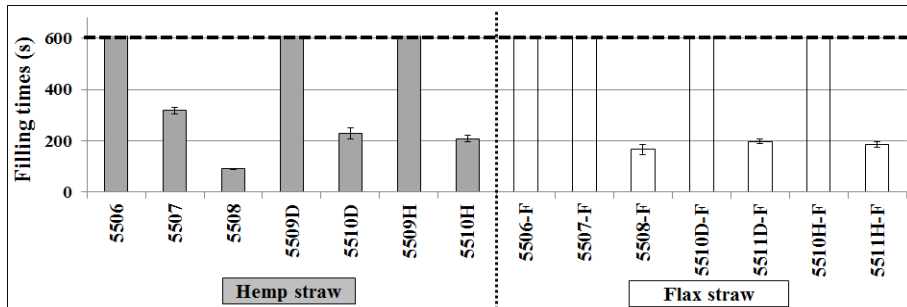

Figure 5: Filling times with VEBE consistometer for studied mixtures.

Studied mixtures have been classed in two groups: first group for mixtures with filling time higher than 600s and the other one for mixtures with filling time smaller than 600s. The choice was to work with mixtures which had filling time higher than 600s. This choice allows an immediate unmolding after casting. Therefore, the W/B ratio chosen is 0.6.

Despite this choice, manufacturing specimens with mixtures including starch was impossible while respecting the density referred to because of their high water content. Adding a superplasticizer was the best solution to decrease the water content in mixtures.

290 4.1.2. Influence of superplasticizer's addition

Figure 6 shows the comparison of the filling times for mixtures with and without superplasticizer including hemp straw (left) or flax straw (right). The capacity of superplasticizer to reduce the W/B ratio is clearly highlighted for the same consistency of mixture. Adding 1.3% of superplasticizer induce a decrease
 295 about of 30% and 35% of water content for mixtures including hemp or flax straw, respectively.

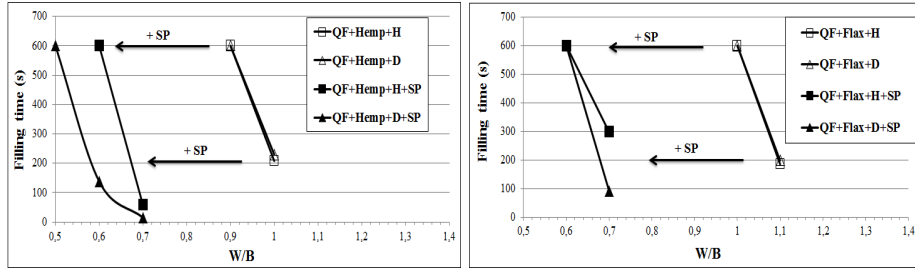

Figure 6: Filling times for mixtures including hemp straw (left) or flax straw (right).

Three prismatic specimens of $7 \times 7 \times 28 \text{ cm}^3$ per formulation had been manufactured with the same wet density. These specimens were stored at ambient conditions at $20 \pm 2^\circ\text{C}$ and $50 \pm 5\%$ RH. The observations during the drying
 300 period have shown a proliferation of molds over the specimens. These molds could be caused by the lack of ventilation in the storage piece and the high water content. Moreover mixtures have a pH about of 8, which is a favorite environment to develop the microorganisms. However, according to several studies
 [1, 30, 31] microbial proliferation can sometimes be observed on earth/plant or
 305 concretes/plant materials of construction. the choice was to use a lime to stop the proliferation of molds. The lime, in sufficient percentage, allows to increase the pH of mixtures.

4.1.3. Influence of lime on mixtures consistency

A part of quarry fines has been substituted by lime in each mixture according
310 to several percentages of lime (1, 5, 10 and 30%). These four percentages have
been chosen to determine the optimal percentage of lime which can prevent mold
growth. The lime is mixed with the QF previously then they are incorporated in
the mixture. The letter (L) has been added at the end of each mixture including
a lime.

315 The consistency tests done with these mixtures have shown similar filling times
for mixtures with or without lime. Adding lime to earth/plant mixtures induces
an increase of mixtures pH up to 12 for 30% of lime.

4.2. Manufacturing and observations

After manufacturing, specimens were stored at the same conditions of $20 \pm$
320 2°C and $50 \pm 5\%$ RH. Figure 7 presents water content as a function of drying
time for some mixes. This figure shows that all specimens had the same drying
speed. The masses are stabilized at less than 1% after two weeks. Specimens
have between 1.5 to 3% water content when mechanical tests were performed.

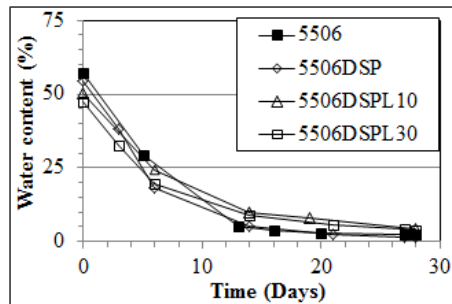

Figure 7: Water content as a function of drying time for some mixtures.

The macro-observations on specimens have shown that specimens including
325 more than 10% and 30% of lime do not present molds. Therefore, only results

obtained with both of these percentages (10 and 30%) will be presented.

Figure 8 shows apparent density 28 days after manufacturing the studied specimens. The values were comprised between 780 and 900 kg/m^3 for specimens with hemp while with flax they were between 850 and 1000 kg/m^3 except for 5506DSP-F.

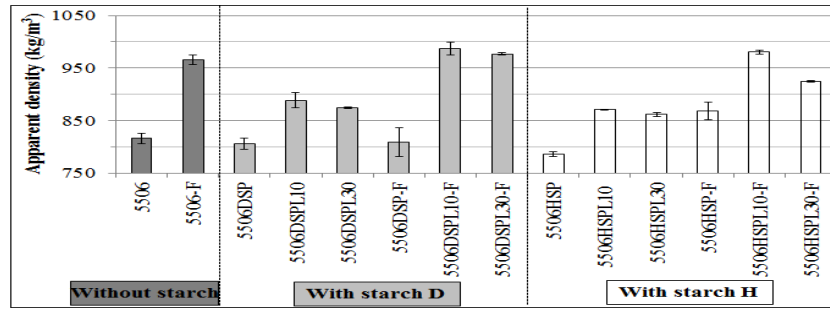

Figure 8: Apparent density of specimens ($7 \times 7 \times 28$) just before the mechanical test.

4.3. Results at hardened state

The mechanical results have been divided in two parts: first one for mechanical results at laboratory samples scale and second one for the study at real scale.

4.3.1. Mechanical results conducted with laboratory specimens

Mechanical tests were done on specimens with QF/hemp or flax straw + starch + superplasticizer + 10 or 30% of lime. Flexural strength results presented in fig.9 show that:

- Adding starch to QF/hemp or flax straw mixtures enhances their flexural strengths which may be linked to the adhesion force between starch and QF particles according to previous research works [17].

345

- The addition of lime causes an increase in the apparent densities of specimens due to its higher dry density (2100 kg/m^3) than that of the FAC (1860 kg/m^3).

350

- Adding lime at 10 or 30% leads to a small enhance in flexural strengths at this age. For specimens including flax with starche D, the gain is more important. This increase in flexural strengths in presence of lime may be linked to their higher apparent density in addition to the adhesion force between starch D, QF and lime particles.

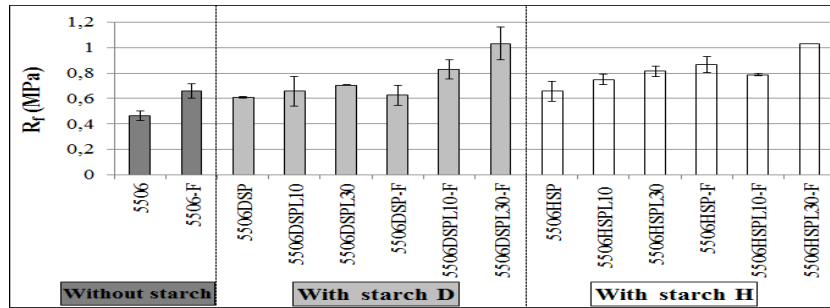

Figure 9: Flexural strength of specimens ($7 \times 7 \times 28 \text{ cm}^3$) 28 days after manufacturing.

The presence of plant in earth specimens avoids a sudden rupture, which means that specimen passes from a fragile behavior to an almost ductile behavior (Fig. 10). Perrot et al were observed a similar behavior on their samples [32].

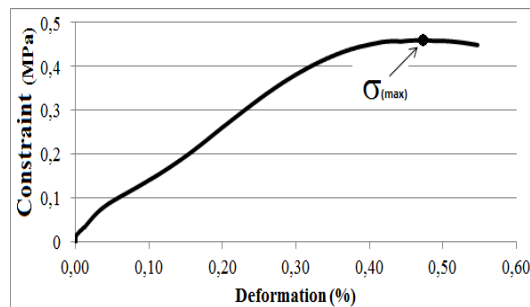

Figure 10: Flexural strength .

In order to verify the influence of hemp and flax straws on these mixtures, the
 355 percentage of aggregates had been increased in mixtures which gives a lighter
 weight. Therefore, the binder/aggregate ratio (B/A) has been decreased to
 3.5. This step aims to study the effect of density on the mechanical strengths.
 For that purpose, three specimens per formulation were manufactured with the
 same wet density. The increase in the proportion of vegetable aggregates in
 360 these mixtures lead us to increase the water content. The percentage of lime is
 chosen as 30% of binder part which gives a best cohesion between binder and
 aggregates.

By following the same process of manufacturing, the drying time was similar
 for all specimens and the masses were stable after 2 weeks. Apparent masses
 365 measured before mechanical test are presented in figure 11. Apparent masses
 for these specimens were included between 450 and 600 kg/m^3 .

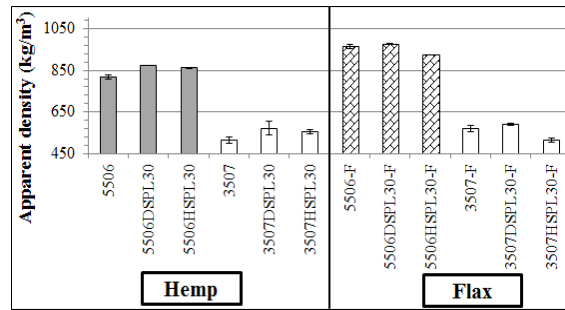

Figure 11: Apparent density of specimens ($7 \times 7 \times 28 \text{ cm}^3$) with (B/A = 3.5 and 5.5).

Flexural strength results obtained with these specimens are presented on
 figure 12. These results show that:

- The increase in the proportion of aggregates has a negative effect on flex-
 370 ural strengths. Flexural strengths obtained are included between 0.07 and
 0.5 MPa with a decrease up to 75% for the referred specimens and between
 (30 to 50%) for specimens including starch, lime and superplasticizer.

- Adding starch D or H + superplasticizer + lime increases flexural strengths which may be linked to the presence of starch according to previous research works [17].
- Starch D gives best resistances with both of hemp and flax straw specimens, which may be linked to its higher density in comparison with specimens including the other starch.

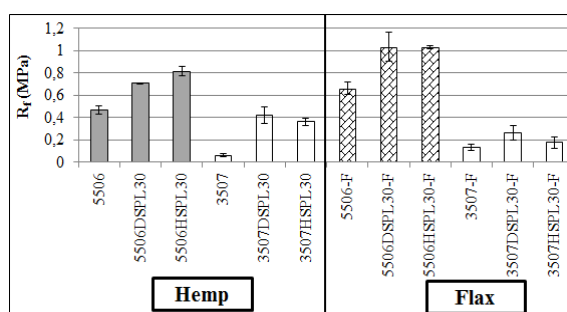

Figure 12: Flexural strength of specimens ($7 \times 7 \times 28 \text{ cm}^3$) with ($B/A = 3.5$ and 5.5) 28 days after manufacturing.

4.3.2. Mechanical results on blocks

In order to verify the results obtained with the laboratory specimens, series of blocks ($50 \times 65 \times 7 \text{ cm}^3$) have been manufactured in following the same protocols than for laboratory specimens. The tile dimensions are chosen to be comparable with those already marketed like gypsum block or cellular concrete. Two blocks has been manufactured for each formulation with the same wet density, under two layers manually compacted. Blocks were unmolded immediately and stored under the conditions of $20 \pm 2^\circ\text{C}$ and $50 \pm 5\% \text{ RH}$.

After 28 days of storage, apparent density has been measured and mechanical tests had been done on all blocks. The target load for blocks is the same that required by European standard for plaster blocks [25] ($R_f = 0.78 \text{ MPa}$).

Figure 13 shows apparent density 28 days after manufacturing. The addition of

lime causes an increase in the apparent densities of specimens due to its higher dry density (2100 kg/m^3) than that of the FAC (1860 kg/m^3).

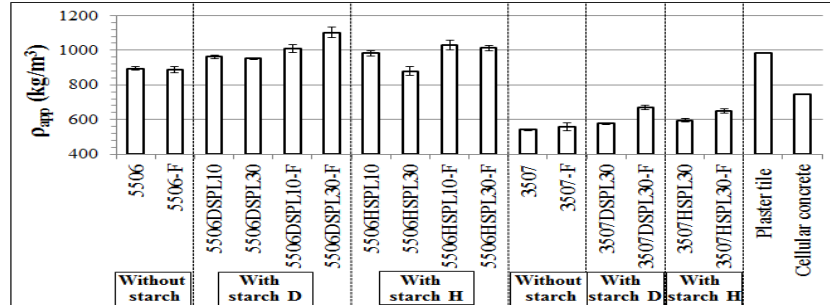

Figure 13: Apparent densities of blocks ($50 \times 65 \times 7 \text{ cm}^3$) 28 days after manufacturing.

Figures 14 and 15 show flexural strength (R_f) and compressive strength (f_c) of studied blocks with hemp and flax straw. Mechanical tests at real scale show that :

395

- Studied blocks have also ductile behaviors at the rupture.
- Starch D gives best resistances with both of hemp and flax straw blocks. Blocks made with $B/A = 5.5$, including QF (70%), hemp or flax straw, starch, SP and lime (30%), reach the required flexural strengths for plaster blocks (0.78 MPa) and give a higher resistance than that of cellular concrete.
- With a lime proportion of 30%, flexural strengths increase widely in comparison with blocks including 10% at a similar apparent density.
- Blocks made with $B/A = 3.5$ have a low resistance but efficient to support their dead load satisfying for a non-bearing wall.

405

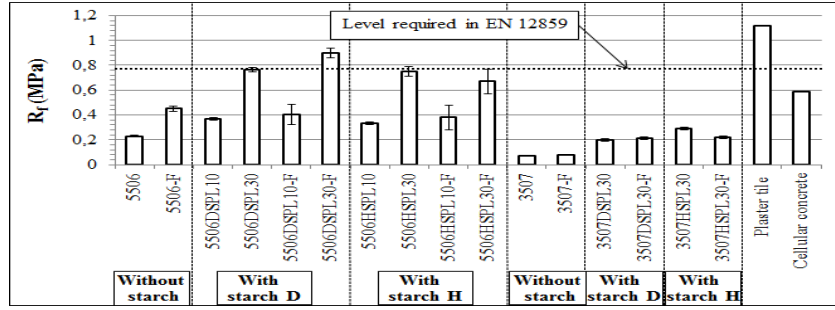

Figure 14: Flexural strength of blocks ($50 \times 65 \times 7 \text{ cm}^3$) 28 days after manufacturing.

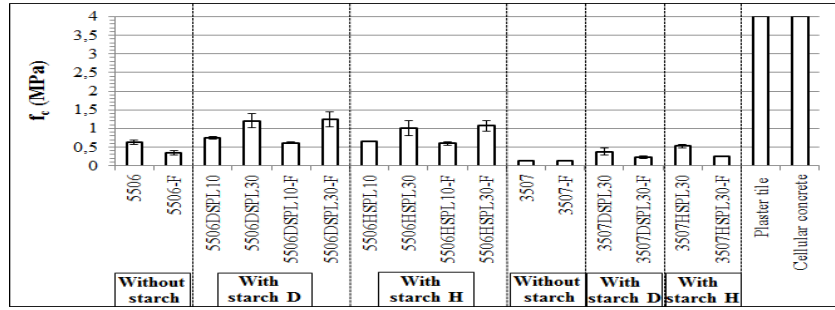

Figure 15: Compressive strength of blocks ($50 \times 65 \times 7 \text{ cm}^3$) 28 days after manufacturing.

4.3.3. Relation between flexural strength and apparent density

To verify the correlation between results, figure 16 shows the evolution of flexural strengths according to apparent density of all the studied mixtures. Treatment of these results allows us to put studied formulations in two groups
 410 first one for QF/plant specimens and the second one for QF/plant with starch, superplasticizer and lime. Both of them follow an empirical law with polynomial form:

$$R_f = a \times \rho_{app}^2 - b \times \rho_{app} \quad (7)$$

These two groups have the same coefficient (a) but a different coefficient (b).

$$\text{Mixtures without starch: } R_f = 1.1E^{-6} \times \rho_{app}^2 - 4E^{-4} \times \rho_{app} \quad (8)$$

$$\text{Mixtures with starch: } R_f = 1.1E^{-6} \times \rho_{app}^2 - 5E^{-5} \times \rho_{app} \quad (9)$$

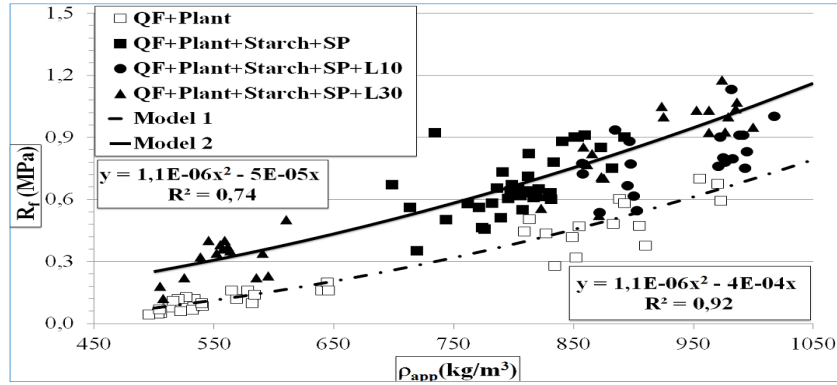

Figure 16: Relation between flexural strength and apparent density.

This equation allows us to target a level of resistance according to the chosen
 415 density.

4.4. Thermal and acoustic insulation results

Several mixes described in the previous section were tested. The particles
 of hemp and flax straw were also tested alone. Figure 17 shows a comparison
 between thermal characteristics of tested samples with other products like
 420 gypsum block and cellular concrete (CC), tested in laboratory, and compressed
 earth block (CEB) tested by Flament [26]. In this figure, mentioned samples
 35, 35-F, 55 and 55-F show an average of thermal values for formulations with
 or without starch, superplasticizer and lime (3 samples per formulation). Thermal
 results presented in figure 17 show that:

- 425
- The presence of starch, superplasticizer and/or lime has negligible influence on thermal results.
 - The particles of hemp and flax straw have a similar thermal behavior with a thermal conductivity of about $0.06 \text{ (W} \times \text{m}^{-1} \times \text{K}^{-1})$ and a specific

heat capacity close to $13500 \text{ (J} \times \text{m}^{-2} \times \text{K}^{-1}\text{)}$.

- 430 • The thermal conductivity of CEB decreased by about 50% and 75% with the addition of 18 and 28%, respectively, of plant particles (hemp or flax straw). This improvement of thermal insulation demonstrates the interest of studying earth/plant products.
- 435 • The association QF/hemp or flax straw (with $B/A = 5.5$) gives a product with a better thermal conductivity (about $0.22 \text{ W} \times \text{m}^{-1} \times \text{K}^{-1}$) than that of a gypsum block (about $0.32 \text{ W} \times \text{m}^{-1} \times \text{K}^{-1}$) and close to that of a cellular concrete (about $0.19 \text{ W} \times \text{m}^{-1} \times \text{K}^{-1}$).
- 440 • The thermal results of studied formulations (with $B/A = 5.5$) are better than those of gypsum blocks with the same density. Furthermore, samples (with $B/A = 3.5$) give a better thermal conductivity about $0.12 \text{ (W} \times \text{m}^{-1} \times \text{K}^{-1}\text{)}$ and a specific heat capacity close to $30000 \text{ (J} \times \text{m}^{-2} \times \text{K}^{-1}\text{)}$.

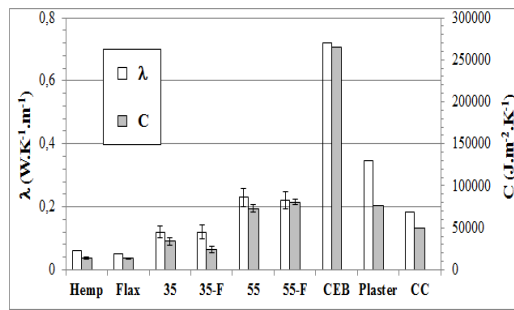

Figure 17: Thermal characteristics of studied samples.

For acoustic measurements, it was impossible to do acoustic test on hemp or flax straw alone with the same protocol than QF/plant samples. Figure 18 presents a comparison between acoustic absorption coefficients of studied samples with both of $B/A = 3.5$ and 5.5 .

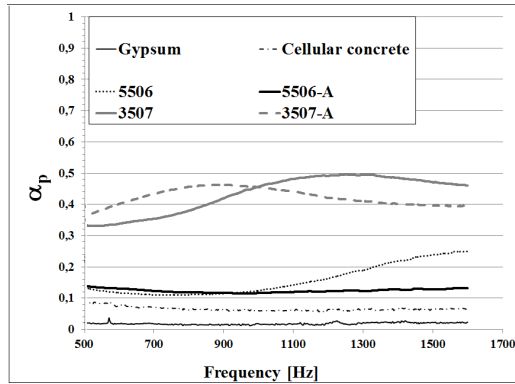

Figure 18: Acoustic absorption coefficient of studied samples.

Results show that an increase in the plant proportion in samples from 18 to 28% enhances about three to four times the acoustic absorption coefficient. Samples with $B/A = 3.5$ give a good acoustic absorption for medium and high sound emissions. However, developed formulations (with $B/A = 3.5$ and 5.5) give better acoustic absorption than that of a gypsum block and a cellular
450 gypsum block, which could be justify by the porosity of plant particles. It should be noted that the state of samples surface (flat, smooth, presence of voids, etc.) plays a very important role on the results of acoustic measurements, especially at low frequencies.

455 5. Conclusion

In this research, several formulations have been studied to evaluate the influence of starch on the properties of QF/hemp or flax straw materials. The results of this work could be concluded as follows:

- Adding starch to QF/hemp or flax straw mixtures increases their W/B
460 ratio and improves its implementation which allows an unmolding immediate. Whereas, adding lime with sufficient percentage seems to give a

better cohesion between binder and plant particles especially with the decrease of B/A ratio and it is interesting to do additional tests to confirm this phenomenon.

- 465 • Adding both of studied starches (D or H) increases flexural and compressive strengths of QF/hemp or flax straw samples.
- The presence of lime from 10% allows to stop the proliferation of moulds on studied specimens.
- Several studied blocks based on QF/lime (70/30) + hemp or flax straw +
470 starch D or H + superplasticizer (with B/A = 5.5) reach the recommended flexural strength for gypsum block and exceed that of cellular concrete.
- The study of the relation between flexural strength and density has shown that tested specimens follow an empirical law with polynomial form.
- Thermal and acoustic measurements have shown a similar behaviour between
475 QF/hemp straw and QF/flax straw. Studied samples made with B/A = 3.5 give good performances of insulation.

Acknowledge

The authors would like to thank the company Carrières du Boulonnais, Roquette society, AKTA and Sika for sending the materials to the lab and
480 enlightening the discussions on the project results.

The authors also thank Jérôme Lefebvre, Emmanuel Antczak, Philippe Herin, researchers at University of Artois, for their contribution in thermo-acoustic tests.

References

- 485 [1] V. Dubois, E. Wirquin, C. Flament, P. Sloma, Fresh and hardened state
properties of hemp concrete made up of a large proportion of quarry fines for
the production of blocks, *Construction and Building Materials* 102 (2016)
84 – 93.
- [2] Y. Brouard, N. Belayachi, D. Hoxha, N. Ranganathan, S. Mo, Mechani-
490 cal and hygrothermal behavior of clay sunflower (*helianthus annuus*) and
rape straw (*brassica napus*) plaster bio-composites for building insulation,
Construction and Building Materials 161 (2018) 196 – 207. doi:<https://doi.org/10.1016/j.conbuildmat.2017.11.140>.
- [3] M. Degrave-Lemeurs, P. Gl, A. H. de Menibus, Acoustical properties of
495 hemp concretes for buildings thermal insulation: Application to clay and
lime binders, *Construction and Building Materials* 160 (2018) 462 – 474.
doi:<https://doi.org/10.1016/j.conbuildmat.2017.11.064>.
URL <http://www.sciencedirect.com/science/article/pii/S0950061817322419>
- 500 [4] A. Laborel-Prneron, J. Aubert, C. Magniont, C. Tribout, A. Bertron,
Plant aggregates and fibers in earth construction materials: A re-
view, *Construction and Building Materials* 111 (2016) 719 – 734.
doi:<https://doi.org/10.1016/j.conbuildmat.2016.02.119>.
URL <http://www.sciencedirect.com/science/article/pii/S0950061816301805>
- 505 [5] B. Mazhoud, F. Collet, S. Pretot, C. Lanos, Mechanical proper-
ties of hemp-clay and hemp stabilized clay composites, *Construc-
tion and Building Materials* 155 (2017) 1126 – 1137. doi:<https://doi.org/10.1016/j.conbuildmat.2017.08.121>.

- 510 URL <http://www.sciencedirect.com/science/article/pii/S0950061817317282>
- [6] G. Araya-Letelier, J. Concha-Riedel, F. Antico, C. Valds, G. Cceres, Influence of natural fiber dosage and length on adobe mixes damage-mechanical behavior, *Construction and Building Materials* 174 (2018) 645 – 655.
515 doi:<https://doi.org/10.1016/j.conbuildmat.2018.04.151>.
URL <http://www.sciencedirect.com/science/article/pii/S0950061818309589>
- [7] K. E. Azhary, Y. Chihab, M. Mansour, N. Laaroussi, M. Garoum, Energy efficiency and thermal properties of the composite material clay-straw,
520 *Energy Procedia* 141 (2017) 160 – 164, power and Energy Systems Engineering. doi:<https://doi.org/10.1016/j.egypro.2017.11.030>.
URL <http://www.sciencedirect.com/science/article/pii/S187661021735436X>
- [8] M. Labat, C. Magniont, N. Oudhof, J.-E. Aubert, From the experimental characterization of the hygrothermal properties of
525 straw-clay mixtures to the numerical assessment of their buffering potential, *Building and Environment* 97 (2016) 69 – 81.
doi:<https://doi.org/10.1016/j.buildenv.2015.12.004>.
URL <http://www.sciencedirect.com/science/article/pii/S0360132315302018>
530
- [9] D. M. Andres, D. L. Manea, R. Fechete, E. Jumate, Clay mortar performance improvement by modifying the physical characteristics of wheat straw, *Procedia Technology* 22 (2016) 335 – 342, 9th International Conference Interdisciplinarity in Engineering,
535 INTER-ENG 2015, 8-9 October 2015, Tirgu Mures, Romania.

doi:<https://doi.org/10.1016/j.protcy.2016.01.106>.

URL <http://www.sciencedirect.com/science/article/pii/S2212017316001079>

[10] D. M. Andres, D. L. Manea, R. Fechete, E. Jumate, Green plastering
540 mortars based on clay and wheat straw, *Procedia Technology* 22 (2016)
327 – 334, 9th International Conference Interdisciplinarity in Engi-
neering, INTER-ENG 2015, 8-9 October 2015, Tirgu Mures, Romania.
doi:<https://doi.org/10.1016/j.protcy.2016.01.105>.

URL <http://www.sciencedirect.com/science/article/pii/S2212017316001067>
545

[11] L. Aouba, C. Bories, M. Coutand, B. Perrin, H. Lemerrier, Properties of
fired clay bricks with incorporated biomasses: Cases of olive stone flour
and wheat straw residues, *Construction and Building Materials* 102 (2016)
7 – 13. doi:<https://doi.org/10.1016/j.conbuildmat.2015.10.040>.

URL <http://www.sciencedirect.com/science/article/pii/S0950061815304517>
550

[12] W. Schmidt, H. J. H. Brouwers, H.-C. Kuhne, B. Meng, Enhance the rhe-
ological and mechanical properties of clayey materials by adding starches,
Applied Rheology. 23 (5) (2013) 12.

555 [13] A. Le, A. Gacoin, A. Li, T. Mai, M. Rebay, Y. Delmas, Experimen-
tal investigation on the mechanical performance of starchhemp compos-
ite materials, *Construction and Building Materials* 61 (2014) 106 – 113.
doi:<https://doi.org/10.1016/j.conbuildmat.2014.01.084>.

[14] A. Le, A. Gacoin, A. Li, T. Mai, N. E. Wakil, Influence of various
560 starch/hemp mixtures on mechanical and acoustical behavior of starch-

- hemp composite materials, *Composites Part B: Engineering* 75 (2015) 201 – 211. doi:<https://doi.org/10.1016/j.compositesb.2015.01.038>.
- [15] A. Akindehinde, W. Schmidt, E. Iyukes, The influence of starches on some properties of concretes, *Proceedings in Advances in Cement and Concrete Technology in Africa*.2015.
- [16] L. Crépy, J.-Y. Petit, E. Wirquin, P. Martin, N. Joly, Synthesis and evaluation of starch-based polymers as potential dispersants in cement pastes and self leveling compounds, *Cement and Concrete Composites* 45 (2014) 29 – 38. doi:<https://doi.org/10.1016/j.cemconcomp.2013.09.004>.
- [17] G. Alhaik, M. Ferreira, V. Dubois, E. Wirquin, S. Tilloy, E. Monflier, G. Aouad, Enhance the rheological and mechanical properties of clayey materials by adding starches, *Construction and Building Materials* 139 (2017) 602 – 610.
- [18] AFNOR, Aggregates for concrete, EN 12620 (2008).
- [19] AFNOR, Non-destructive testing - X-ray diffraction from polycrystalline and amorphous material - Part 2: procedures. EN 13925-2 (2003).
- [20] A. Buléon, P. Colonna, V. Planchot, S. Ball, Starch granules : structure and biosynthesis., *International Journal of Biological Macromolecules*. 23 (1998) 85–112.
- [21] S. Amziane, F. Collet, M. Lawrence, C. Magniont, V. Picandet, M. Sonebi, Recommendation of the rilem tc 236-bbm: characterisation testing of hemp shiv to determine the initial water content, water absorption, dry density, particle size distribution and thermal conductivity, *Materials and Structures* 50 (3) (2017) 167. doi:[10.1617/s11527-017-1029-3](https://doi.org/10.1617/s11527-017-1029-3).
URL <https://doi.org/10.1617/s11527-017-1029-3>

- [22] AFNOR, NF EN 196-1: Méthodes d'essais des ciments - Partie 1: détermination des résistances mécaniques (2006).
- [23] AFNOR, Testing fresh concrete - Part 3: Vebe test. EN 12350-3 (2012).
- [24] AFNOR, Testing hardened concrete - Part 5: flexural strength of test specimens. EN 12390-5 (2012).
590
- [25] AFNOR, Gypsum blocks: Definitions, requirements and test methods. NF EN 12859 (2011).
- [26] C. Flament, Valorisation des fines de lavage de granulats : application à la construction en terre crue, Ph.D. thesis, University of Artois (2013. [in French]).
595
- [27] V. CERREZO, Propriétés mécaniques, thermiques et acoustiques d'un matériau base de particules végétales : approche expérimentale et modélisation théorique, Ph.D. thesis, Lyon: Institut National des Sciences Appliquées de Lyon (16 juin 2005. [in French]).
- [28] AFNOR, Thermal performance of building materials and products - Determination of thermal resistance by means of guarded hot plate and heat flow meter methods Products of high and medium thermal resistance. EN 12667 (2001).
600
- [29] AFNOR, Acoustics - Determination of sound absorption coefficient and impedance in impedance tubes - Part 2: Transfer-function method. EN ISO 10534-1 (2003).
605
- [30] Rammed Earth Conservation, c. mileto and f. vegas and v. cristini. Edition, Taylor and Francis Group, 2012.

- [31] S. Marceau, P. Glé, M. Gueguen, E. Gourlay, S. Moscardelli, I. Nou,
610 S. Amziane, L. Abdellaoui, Assessment of the durability of bio-based in-
sulating materials., Proceedings in First International Conference on Bio-
based Building Materials (2015) 198–202.
- [32] A. Perrot, D. Rangeard, F. Menasria, S. Guihneuf, Strategies
for optimizing the mechanical strengths of raw earth-based mor-
615 tars, Construction and Building Materials 167 (2018) 496 – 504.
doi:<https://doi.org/10.1016/j.conbuildmat.2018.02.055>.
URL [http://www.sciencedirect.com/science/article/pii/
S0950061818302885](http://www.sciencedirect.com/science/article/pii/S0950061818302885)