



HAL
open science

Contrary to ultra-processed foods, the consumption of unprocessed or minimally processed foods is associated with favorable patterns of protein intake, diet quality and lower cardiometabolic risk in French adults (INCA3)

Marion Salomé, Laura Arrazat, Juhui Wang, Ariane Dufour, Carine Dubuisson, Jean-Luc J.L. Volatier, Jean-François Huneau, François Mariotti

► **To cite this version:**

Marion Salomé, Laura Arrazat, Juhui Wang, Ariane Dufour, Carine Dubuisson, et al.. Contrary to ultra-processed foods, the consumption of unprocessed or minimally processed foods is associated with favorable patterns of protein intake, diet quality and lower cardiometabolic risk in French adults (INCA3). *European Journal of Nutrition*, 2021, 10.1007/s00394-021-02576-2 . hal-03280956

HAL Id: hal-03280956

<https://hal.science/hal-03280956>

Submitted on 7 Jul 2021

HAL is a multi-disciplinary open access archive for the deposit and dissemination of scientific research documents, whether they are published or not. The documents may come from teaching and research institutions in France or abroad, or from public or private research centers.

L'archive ouverte pluridisciplinaire **HAL**, est destinée au dépôt et à la diffusion de documents scientifiques de niveau recherche, publiés ou non, émanant des établissements d'enseignement et de recherche français ou étrangers, des laboratoires publics ou privés.

This is the “postprint” version, i.e. the authors’ version that has been accepted for publication, of the article by Salomé et al., finally published in European Journal of Nutrition, published online: 8 May 2021.

Full reference is:

Salomé, M., Arrazat, L., Wang, J. et al. Contrary to ultra-processed foods, the consumption of unprocessed or minimally processed foods is associated with favorable patterns of protein intake, diet quality and lower cardiometabolic risk in French adults (INCA3). *Eur J Nutr* (2021).

**The edited final article can be found on the publisher website,
at: <https://doi.org/10.1007/s00394-021-02576-2>**

Contrary to ultra-processed foods, the consumption of unprocessed or minimally processed foods is associated with favorable patterns of protein intake, diet quality and lower cardiometabolic risk in French adults (INCA3).

Marion Salomé^{1§}, Laura Arrazat^{1§}, Juhui Wang¹, Ariane Dufour², Carine Dubuisson², Jean-Luc Volatier², Jean-François Huneau¹, François Mariotti^{1*}

¹Université Paris-Saclay, AgroParisTech, INRAE, UMR PNCA, 75005, Paris, France

²Risk Assessment Department, Methodology and Survey Unit, French Agency for Food, Environmental and Occupational Health & Safety (ANSES), 14 rue Pierre et Marie Curie, 94701 Maisons-Alfort Cedex, France

§ These authors contributed equally to this work.

Short title: Ultra-processed foods, protein intake and diet quality

* Corresponding author: François Mariotti, 16 rue Claude Bernard, 75005 Paris, France, francois.mariotti@agroparistech.fr

ORCID number:

Jean-François Huneau : [0000-0001-7336-2617](https://orcid.org/0000-0001-7336-2617) ; François Mariotti: [0000-0002-4516-3853](https://orcid.org/0000-0002-4516-3853)

Acknowledgments

The authors would like to thank Benjamin Allès (Nutritional Epidemiology Research Team (EREN) at Université Paris 13, France) for his scientific support in constructing the NOVA database and Emmanuelle Kesse-Guyot (Nutritional Epidemiology Research Team (EREN) at Université Paris 13, France) for her scientific contribution to the constitution of the disease mortality database for the EpiDiet model.

List of abbreviations

ANSES, French Agency for Food, Environmental and Occupational Health and Safety; AS, Adequacy Subscore; BI, Berry-Index; BI-ABF, Berry-Index – Animal-based families; BI-PBF, Berry-Index – Plant-based families; CIQUAL, French Centre for Information on Food Quality; EpiDiet, Evaluate the Potential Impact of a Diet; hPDI, healthful Plant-based Diet Index; INCA3, Third Individual and National Study on Food Consumption Survey; MPF, unprocessed/minimally processed foods; MPFp, proportion of total energy intake from MPF; MS, Moderation Subscore; PANDiet, Probability of Adequate Nutrient Intake; PDI, Plant-based Diet Index; PF, processed foods; PFp, proportion of total energy intake from PF; uPDI, unhealthful Plant-based Diet Index; UI, uncertainty interval; UPF, ultra-processed foods; UPFp, proportion of total energy intake from UPF.

Declarations**Funding**

M Salomé's PhD fellowship is currently being funded by a research contract with Terres Univia, the French Interbranch organization for plant oils and proteins. F Mariotti is the scientific leader of this contract.

Conflicts of interest/Competing interests

The authors declare that they have no competing interests.

Ethics approval

The INCA3 study was carried out in accordance with the Declaration of Helsinki guidelines and was approved by the 'Comité Consultatif sur le Traitement de l'Information en matière de Recherche dans le domaine de la Santé' (Advisory Committee on Information Processing in Health Research).

Consent to participate

For the data collection of the INCA3 survey, oral consent was obtained, witnessed and formally recorded from participants.

Consent for publication

Not applicable

Availability of data and materials

The datasets of the INCA3 survey are available at data.gouv.fr. Data sets generated during the current study are available from the corresponding author on reasonable request.

Code availability

Custom code are available from the corresponding author on reasonable request.

Authors' contributions

Marion Salomé, Laura Arrazat and François Mariotti designed research; Marion Salomé, Laura Arrazat and Juhui Wang conducted research; Ariane Dufour, Carine Dubuisson and Jean-Luc Volatier provided the databases essential for the research; Jean-François Huneau provided methodological support. Marion Salomé and Laura Arrazat analyzed data and performed statistical analysis; Marion Salomé, Laura Arrazat, Juhui Wang and François Mariotti interpreted the results; Marion Salomé, Laura Arrazat, Juhui Wang and François

Mariotti wrote paper; Marion Salomé and François Mariotti had primary responsibility for the final content and all authors read and approved the final manuscript.

1 **Abstract**

2 *Purpose.* While the consumption of ultra-processed foods is steadily increasing, there is a
3 growing interest in more sustainable diets that would include more plant protein. We aimed to
4 study associations between the degree of food processing, patterns of protein intake, diet
5 quality and cardiometabolic risk.

6 *Methods.* Using the NOVA classification, we assessed the proportion of energy from
7 unprocessed/minimally processed foods (MPFp), processed foods (PFp) and ultra-processed
8 foods (UPFp) in the diets of 1774 adults (18-79y) from the latest cross-sectional French
9 national survey (INCA3, 2014-2015). We studied the associations between MPFp, PFp and
10 UPFp with protein intakes, diet quality (using the PANDiet scoring system, the global (PDI),
11 healthful (hPDI) and unhealthful (uPDI) plant-based diet indices) and the risk of
12 cardiometabolic death (using the EpiDiet model).

13 *Results.* MPFp was positively associated with animal protein intake and plant-protein
14 diversity, whereas PFp was positively associated with plant protein intake and negatively with
15 plant-protein diversity. The PANDiet was positively associated with MPFp ($\beta=0.14$,
16 $P<0.0001$) but negatively with UPFp ($\beta=-0.05$, $P<0.0001$). These associations were modified
17 by adjustment for protein intakes and plant-protein diversity. As estimated with comparative
18 risk assessment modeling between extreme tertiles of intake, mortality from cardiometabolic
19 diseases would be decreased with higher MPFp (e.g. by 31% for ischemic heart diseases)
20 and increased with UPFp (by 42%) and PFp (by 11%).

21 *Conclusions.* In the French population, in contrast with UPFp, a higher MPFp was associated
22 with a higher animal protein intake, a better plant-protein diversity, a higher diet quality and a
23 markedly lower cardiometabolic risk.

24 *Keywords:* Ultra-processed Foods, Dietary Plant Protein, Dietary Animal Protein, Diet
25 Quality, Plant-Based Diet.

26 **Introduction**

27 The development of industrially-produced foods is reshaping our food system and therefore
28 influencing diets worldwide. At present, in many high-income countries such as the USA or
29 UK, ultra-processed foods (UPF) (usually defined as convenient food and drink products with
30 high industrial processing and generally many ingredients increasing shelf life and
31 palatability [1, 2]), contribute more than half of dietary energy intake [3, 4]. In middle-income
32 countries, this percentage is lower but is seeing a sharp rise [5]. The UPF available on the
33 market are usually rich in energy, saturated fats, sugar and salt [4, 6]. They also have lower
34 protein content than less processed foods and diets high in UPF have been associated with
35 lower protein intake [4, 7].

36 In high-income countries, animal-based foods are the major source of protein but also have
37 an important environmental footprint [8, 9]. Therefore, with regard to the global environmental
38 impacts of the food system, a plant-based protein transition seems necessary to achieve
39 more sustainable diets [10, 11].

40 However, although plant-based diets are known to have a positive impact on health [12–14],
41 plant-based food products differ in terms of their quality and contribution to current diets. In
42 particular, it has been shown that the associations between plant-based diets and incidences
43 of coronary heart disease or type 2 diabetes are dependent on the types of plant foods
44 consumed, whether they are considered as healthy plant foods (e.g. whole grains, fruits, etc.)
45 or less-healthy plant foods such as more processed foods (e.g. sweetened beverages, fries,
46 etc.) [15, 16]. Furthermore, it has been recently reported that some vegetarians diets are
47 associated with high consumption of ultra-processed foods [17] suggesting that the benefit of
48 diets high in plant-based foods may depend on the actual share of ultra-processed foods.

49 Indeed, an overall increase in the consumption of UPF has been thought to play a major role
50 in the pandemics of obesity and diet-related chronic diseases [18, 19]. Many studies have
51 recently reported associations between the consumption of UPF and non-communicable
52 diseases [20–23] or mortality rates [24, 25]. An inpatient randomized controlled trial, where

53 ultra-processed and unprocessed diets were matched for presented energy and
54 macronutrients, reported that the consumption of ultra-processed foods resulted in a higher
55 energy intake (by ~500 kcal) and a 0.9 kg increase in body weight [26].

56 Therefore, the aim of this study was to investigate the consumption of foods with different
57 processing degrees and the associated intake of animal or plant protein, the diet quality and
58 predicted long-term health. We hypothesized that the degree of processing of foods in the
59 diet is differentially associated with plant/animal protein sources, and that it could explain the
60 resulting association with the diet quality and cardiometabolic health.

61 **Subjects and Methods**

62 ***Population and dietary data***

63 The population studied was derived from the third Individual and National Study on Food
64 Consumption Survey (INCA3), performed in mainland France in 2014-2015 [27]. INCA3 is a
65 nationwide and representative survey and its methodology and design are fully described
66 elsewhere [28]. Of the 2121 adults (18-79y) who completed the whole protocol of the INCA3
67 survey, under-reporting participants were excluded from their basal metabolic rate estimated
68 using the Henry equation [29] and the cutoff points proposed by Black [30]. The final sample
69 thus contained 1774 adults (749 males and 1025 females) (Supplementary Figure S1).

70 Food and beverage consumption was recorded using three nonconsecutive 24-h dietary
71 recalls (two on weekdays, one at the week-end) over a 3-wk period. Dietary recalls were
72 carried out by phone by professional investigators, assisted by the dietary software
73 GloboDiet [31], and participants were not aware of the days of recall so they could not
74 anticipate it. The nutrient contents of the foods and beverages were extracted from the 2016
75 database generated by the French Center for Information on Food Quality (*Centre*
76 *d'Information sur la Qualité des Aliments; CIQUAL*) [32]. Food items were classified into
77 groups and sub-groups. Individual sociodemographic characteristics were collected from
78 face-to-face and self-administered questionnaires [28].

79 ***Degree of food processing***

80 The NOVA classification [1] was applied to assess the degree of food processing for each
81 food product in the INCA3 database. This classification encompasses four groups: 1)
82 unprocessed/minimally processed foods (MPF), 2) processed culinary ingredients, 3)
83 processed foods (PF) and 4) ultra-processed foods (UPF). To discriminate different foods
84 between these categories, the classification takes account of the technical processing
85 technique, the presence of additives and product composition. The present study focused on
86 MPF, PF and UPF consumption.

87 For most of the food items consumed, the method of preparation was known. If the food was
88 homemade, eaten in a restaurant or prepared by an artisan, it was broken down into its
89 ingredients to which the NOVA classification was applied. If the food was industrially
90 processed or came from a fast food restaurant, the NOVA classification was applied directly
91 to the food item according to its degree of processing. If the method of preparation was
92 unknown for a food item eaten by a participant, the most common method of preparation
93 observed in the population for this particular food was assigned. For each participant the
94 proportion (%) of total energy intake from unprocessed/minimally processed foods (MPFp),
95 processed culinary ingredients, processed foods (PFp) and ultra-processed foods (UPFp)
96 was calculated.

97 ***Identification of protein sources***

98 Using the decomposition of food items into ingredients, the protein origin of each ingredient
99 was assigned to a food family. Food families were either plant-based (“Refined grains”,
100 “Whole grains”, “Legumes”, “Nuts and seeds”, “Fruits”, “Vegetables”, “Potatoes” and “Other
101 plant foods”) or animal-based (“Red meat”, “Poultry”, “Fish”, “Processed meat”, “Other
102 meats”, “Eggs”, “Cheeses”, “Milk”, “Yogurt”, and “Other dairy products”).

103 The contribution of each plant-based family to plant protein intake was characterized using
104 the Berry-Index – Plant-based families (BI-PBF) plant protein diversity index, as previously
105 described [33]. The Berry-Index was used in previous studies to evaluate the evenness of

106 the distribution of total energy intake among food groups [34, 35]. The BI-PBF index is
107 defined as $1 - \sum_{i=0}^n s_i^2$, where s_i is the share of plant-based family i in plant-protein intake,
108 and n is the total number of plant-based families. A higher score reflects greater diversity
109 with a more balanced contribution of each plant-based family to plant protein intake.
110 Likewise, the Berry-Index – Animal-based families (BI-ABF) was used to assess the diversity
111 of the contribution of animal-based families to animal protein intake.

112 ***Nutrient adequacy of the diet***

113 The nutrient adequacy of the diet was assessed using version 3.1. of the Probability of
114 Adequate Nutrient Intake (PANDiet) scoring system [36, 37], based mainly on the dietary
115 reference intake from the 2016 opinion issued by the French Agency for Food,
116 Environmental, and Occupational Health and Safety (ANSES) [38]. The reference values
117 were adapted to take account of the different nutrient requirements of adults aged over 65y
118 [39]. The PANDiet score is the mean of the adequacy subscore (AS) and the moderation
119 subscore (MS). AS is the mean of the probabilities of adequacy for 27 nutrients for which the
120 usual intake should be above a reference value, multiplied by 100. MS is the mean of the
121 probabilities of adequacy for six nutrients for which an upper bound reference value exists,
122 multiplied by 100 (Supplementary Table S1). Each probabilities of adequacy are calculated
123 using the mean intake, the intra-individual (i.e. day-to-day) variability of intake, the inter-
124 individual variability and the nutrient reference value [36]. The PANDiet score ranges from 0
125 to 100 and the higher the score, the better the overall nutrient adequacy of the diet.

126 ***Adherence to a plant-based diet***

127 The Plant-based Diet Indices, developed by Satija et al. [16], were used to assess how much
128 a diet was based on plant-based foods. The PDIs comprise three indices which distinguish
129 plant-based foods according to their impact on health: the overall plant-based diet index
130 (PDI), the healthful plant-based diet index (hPDI) and the unhealthful plant-based diet index
131 (uPDI). To calculate these scores, foods were assigned to healthy plant food groups (whole
132 grains, fruits, vegetables, nuts, legumes, vegetable oils and tea/coffee), less healthy plant

133 food groups (fruit juices, sugar-sweetened beverages, refined grains, potatoes and
134 sweets/desserts), or animal food groups (animal fats, dairy, eggs, fish/seafood, meat and
135 miscellaneous animal-based foods). The consumption of each food group was calculated for
136 each individual. The PDI gives more points to high consumers of plant-based food groups
137 than to those with a high consumption of animal food groups. The hPDI gives more points to
138 high consumers of healthy plant food groups and fewer points to high consumers of less
139 healthy plant food groups and animal food groups. Symmetrically, the uPDI gives more
140 points to high consumers of less healthy plant food groups than to high consumers of healthy
141 plant food groups or animal food groups [15] (Supplementary Table S2).

142 ***Predicting the impact on cardiometabolic death***

143 The impact of dietary patterns on cardiometabolic death was evaluated using the EpiDiet
144 (Evaluate the Potential Impact of a Diet) model, which is a simulation-based nutritional and
145 epidemiologic model that implements the Comparative Risk Assessment framework [11, 40],
146 enabling prediction of the positive or negative impact on long-term health that would result
147 from changes in the diet for an individual, group or population, as previously described [41].
148 The EpiDiet model was written in Python and deployed on a High Performance Computing
149 framework. Two sources of data were used to develop the EpiDiet model. The first source of
150 data was the relative risk estimates that relates the nutritional factors to the disease endpoint
151 and that have been reported in validated international meta-analyses [42–44]. Disease scope
152 was defined according to the International Statistical Classification of Diseases and Related
153 Health Problems [45]. Second, the French population demographics and mortality in 2014
154 (being the year of the dietary survey) were used, provided respectively by the National
155 Institute of Statistics and Economic Studies (INSEE) [46], and the Epidemiological Centre on
156 Medical Causes of Death (CEPIDC) [47]. Nutritional factors and diseases included in the
157 EpiDiet model are presented in Supplementary Figure S2. In this study, only coronary heart
158 diseases, cerebrovascular diseases and diabetes were considered. The EpiDiet model
159 therefore evaluated the potential impacts of dietary changes associated with patterns of

160 intake according to food processing on the number of death from these diseases in the
161 French population, if the whole population was adopting the dietary change.

162 ***Statistical analysis***

163 The population was stratified into tertiles in three different ways according to the proportion of
164 total energy intake from MPF (MPFp), PF (PFp) or UPF (UPFp) in their diet. Cross-classified
165 frequencies of the MPFp, PFp and UPFp tertiles are presented in Supplementary Table S3.

166 Categorical variables are presented as percentages, and differences across the tertiles were
167 assessed by χ^2 test. Continuous variables are presented as means \pm SEM, adjusted for the
168 season of recall, in order to take into account that the degree of processing may depend on
169 the seasonality of food products. Differences across the tertiles of each NOVA group or
170 between the third tertiles of MPFp, PFp and UPFp within the general population were
171 assessed by ANOVA adjusted for the season of recall. Protein intakes were adjusted for total
172 energy intake using the residual method [48]. The weighting schemes proposed in INCA3
173 were used to account for the complex survey design.

174 Associations between diet quality indices (PANDiet and PDIs) and the proportions of total
175 energy intake from MPF, PF and UPF were analyzed using multiple linear regression
176 models. First, the proportions of processed culinary ingredients, PF and UPF were included
177 in the same model in order to study their associations with diet quality indices independently
178 of each other. In this way, associations could be interpreted as the effect of substitution of
179 one of these variables with the proportion of MPF (not included in the model and therefore
180 taken as the reference). Associations with diet quality indices were then estimated separately
181 for the proportions of total energy intake from MPF, PF and UPF, with a further adjustment
182 for protein intakes and/or plant protein diversity. The potential confounding factors included in
183 the models, because of their associations with NOVA groups, were total energy intake
184 (continuous), age (continuous), sex (two levels), educational level (four levels), occupational
185 status (eight levels), city size (five levels), perception of financial status (six levels), season of
186 record (four levels), region of France (five levels) and matrimonial status (five levels).

187 For each NOVA group (MPF, PF and UPF), the EpiDiet model was implemented to compare
188 the first tertile (baseline scenario) with the third tertile (counterfactual scenario). The number
189 of deaths potentially avoided (or, conversely, added) were simulated among French adults
190 from cerebrovascular, ischemic heart diseases and diabetes if the dietary patterns of the
191 French population would shift from the baseline to the counterfactual scenario, according to
192 the number of deaths observed in 2014 in the French population. The population was
193 stratified 5-year age bands and sex in order to take better account of the disparities
194 regarding diet, diseases and relative risks between groups. All foods and nutrients (except
195 sodium) were adjusted for total energy intake using the residual method [49], while fatty
196 acids were expressed as a percentage of total energy intake. Sensitivity analyses were
197 performed to determine the weight of each nutritional factor in the estimation of number of
198 deaths [50].

199 All statistical analyses were performed using SAS version 9.4 (SAS Institute Inc., Cary, NC,
200 USA.), except the EpiDiet model that was performed with Python version 3.7.1. Significance
201 was set at $P < 0.05$.

202

203 **Results**

204 In the overall population, MPF contributed to $32.8 \pm 12.1\%$ of energy intake, PF to $24.9 \pm$
205 12.2% of energy intake and UPF to $30.6 \pm 15.8\%$ of energy intake (data not shown).

206 Participants in the third tertile of MPFp, compared to those in the first tertile, were more likely
207 to be women (57.0% vs 43.4%) and aged over 50y (53.2% vs 29.4%). Participants in the
208 third tertile of PFp, compared to those in the first tertile, were more likely to be men (62.2%
209 vs 40.1%) and aged over 50y (57.2% vs 31.9%). Participants in the third tertile of UPFp,
210 versus those in the first tertile, were more likely to be younger than 35y (46.2% vs 8.7%) with
211 no difference regarding sex (Supplementary Table S4).

212 ***Degree of processing and protein consumption***

213 Compared to the first tertile of MPFp, individuals in the third tertile consumed more animal
214 protein (61.0 g/day vs 51.1 g/day) and plant protein (26.4 g/day vs 25.7 g/day) and had a
215 lower contribution of plant protein in the diet (31.2% of total protein intake vs 35.0%). Red
216 meat, poultry, fish and yogurt contributed more to animal protein intake whereas processed
217 meat and cheese contributed less when compared to the first tertile (Supplementary Table
218 S5). Regarding plant protein intake, refined grains had a lower contribution in the third tertile
219 compared to the first (47.3% vs 60.7%) and other plant-based families made greater
220 contributions which resulted in more plant protein diversity, expressed as BI-PBF (0.64 vs
221 0.55), with a better contribution of different plant protein sources (Fig. 1a).

222

223 **Fig. 1** Contribution of plant-based food families to plant protein intake, expressed as the
224 percentage of plant protein intake, and plant protein diversity, expressed as the Berry-Index
225 – Plant-based families (BI-PBF) across tertiles of the proportion of total energy intake from a.
226 unprocessed/minimally processed foods (MPF), b. processed foods (PF) and c. ultra-
227 processed foods (UPF) in the French adult population INCA3 (n=1774) (Values are means
228 adjusted for the season of recall; * indicates significantly different from the first tertile)

229

230 Total animal protein intake did not change across the tertiles of PFp. However, cheese and
231 processed meat contributed more to animal protein intake whereas milk, eggs and yoghurt
232 contributed less in the third vs the first tertile. Plant protein intake was higher in the third
233 compared to the first tertile of PFp (29.0 g/day vs 23.7 g/day) and so was the proportion of
234 plant protein in the diet (35.7% of total protein intake vs 31.7%) (Supplementary Table S5).
235 The contribution of refined grains to plant protein intake was higher in the third than in the
236 first tertile (62.2% vs 48.8%) resulting in less plant protein diversity (BI-PBF of 0.53 vs 0.64).
237 Therefore, plant protein intake was less evenly distributed among plant protein sources in the
238 third than in the first tertile of PFp (Fig. 1b).

239 Plant protein intake was lower in the third tertile of UPFp than in the first tertile (24.1 g/day vs
240 28.4 g/day and 32.3% of total protein intake vs 35.3%). Animal protein intake did not differ
241 significantly across the UPFp tertiles, but when comparing the third tertile with the first,
242 processed meat and milk contributed more to animal protein intake while poultry, fish and
243 cheese contributed less (Supplementary Table S5). Plant protein diversity did not change
244 significantly across the tertiles (Fig. 1c).

245 ***Degree of processing and food group consumption***

246 As for protein intakes, mean intakes of food groups differed between the third tertiles of the
247 proportion of MPF, PF and UPF in the diet (Supplementary Figure S3). Compared to the
248 general population, participants in the highest tertile of MPFp consumed more plant foods
249 that are usually minimally processed such as soups (+53%), nuts and oilseeds (+50%), and
250 fruits (+36%), animal foods that are usually minimally processed such as fish (+37%), poultry
251 (+32%) or milk (+31%) and less processed meat (-39%), savory pastries (-52%) and
252 alcoholic beverages (-37%). Participants in the highest tertile of PFp consumed more refined
253 bread (+67%), alcoholic beverages (+51%), cheeses (+40%) and processed meats (+15%)
254 and less breakfast cereals (-63%) and sweet beverages (-48%) compared to the general
255 population. Finally, participants in the highest tertile of UPFp consumed less minimally
256 processed plant or animal foods, and more processed meats (+23%), sweet beverages
257 (+70%), breakfast cereals (+63%), savory pastries (+59%), confectionery and chocolate
258 (+39%) and fruit juices (+34%).

259 ***Associations between food processing and diet quality, and related to protein intakes***

260 The PANDiet score and its sub-scores (adequacy sub-score, AS and moderation sub-score,
261 MS) increased with the proportion of MPF and to a lesser extent with the proportion of PF,
262 whereas they decreased in the higher tertile of UPFp. Similarly, the PDI and hPDI scores
263 increased with the proportion of MPF and decreased with the proportion of UPF. The
264 opposite trend was observed for the uPDI score (Fig. 2 and Supplementary Table S6).

265

266 **Fig. 2** Diet quality indices across tertiles of the proportion of total energy intake from
267 respectively unprocessed/minimally processed foods (MPFp), processed foods (PFp) and
268 ultra-processed foods (UPFp) in the French adult population INCA3 (n=1774). a, b and c
269 respectively, PANDiet score, Adequacy sub-score (AS) and Moderation sub-score (MS). d, e
270 and f respectively, Plant-based diet (PDI), Healthy plant-based diet (hPDI) and Unhealthy
271 plant-based diet (uPDI) scores (values are means \pm SEM adjusted for the season of recall; *
272 indicates significantly different from the first tertile)

273

274 In a model using mutually adjusted NOVA categories and representing substitutions for
275 MPFp, PANDiet was negatively associated with increases of PFp ($\beta=-0.11$) and UPFp ($\beta=-$
276 0.16), while uPDI was positively associated with PFp ($\beta=0.12$) and UPFp ($\beta=0.13$) and hPDI
277 was negatively associated with UPFp ($\beta=-0.05$) but not with PFp (Table 1).

278 Associations with PANDiet, hPDI and uPDI were then evaluated independently with respect
279 to MPFp, PFp and UPFp variables (Table 2). The PANDiet score was positively associated
280 with MPFp ($\beta=0.14$), and the association was attenuated when controlling for protein intake
281 and/or plant protein diversity (BI-PBF). PANDiet was not associated with PFp but was
282 associated when controlling for BI-PBF ($\beta=0.05$) and negatively associated when controlling
283 for protein intake ($\beta=-0.08$) and when controlling for protein intake and BI-PBF ($\beta=-0.04$).
284 PANDiet was negatively associated with UPFp ($\beta=-0.05$) in all models except when
285 controlling only for protein intake. hPDI was positively associated with MPFp ($\beta=0.04$) unless
286 controlling for BI-PBF, but not associated with PFp (unless controlling for BI-PBF ($\beta=0.11$) or
287 for protein ($\beta=-0.03$)), and negatively associated with UPFp ($\beta=-0.07$) in all models. uPDI was
288 negatively associated with MPFp ($\beta=-0.13$) in all models but the association was attenuated
289 when controlling for protein intake and BI-PBF, and positively associated with PFp ($\beta=0.04$),
290 unless when controlling for BI-PBF ($\beta=-0.07$), and UPFp ($\beta=0.06$) in all models.

291 Furthermore, the association between the degree of food processing and its impact on health
292 outcomes was estimated according to the dietary patterns computed from the proportion of
293 total energy intake from MPF, PF and UPF taken separately, using the EpiDiet model. Our
294 simulation revealed that diets containing a higher proportion of MPF could be more beneficial
295 to health (Fig. 3). Compared to the figures of death observed in the French population in
296 2014 (9,709 deaths from cerebrovascular diseases, 13,020 from ischemic heart diseases
297 and 3,597 from diabetes), consumption of a diet with higher MPFp (consumption pattern of
298 the 3rd tertile of MPFp compared to the 1st tertile) could potentially decrease the number of
299 deaths from cerebrovascular diseases by 25% [23-27%, 95% uncertainty interval] with 2419
300 deaths being avoided, from ischemic heart diseases by 31% [29-33%, 95%UI] with 4023
301 deaths being avoided, and from diabetes by 19% [16-21%, 95%UI] with 665 deaths being
302 avoided. Meanwhile, higher share of UPFp in the diet (consumption pattern of the 3rd tertile of
303 UPFp compared to the 1st tertile) could increase deaths from metabolic diseases: the
304 theoretical percentage of deaths added was 19% [16-22%, 95%UI] for cerebrovascular
305 diseases (+1880 deaths), 42% [11-73%, 95%UI] for ischemic heart diseases (+5448 deaths)
306 and 30% [-3-63%, 95%UI] for diabetes (+1066 deaths). The same numbers for dietary
307 patterns computed from PFp were 20% [18-22%, 95%UI] for cerebrovascular diseases
308 (+1911 deaths), 11% [6-16%, 95%UI] for ischemic heart diseases (+1419 deaths), and 16%
309 [5-26%, 95%UI] for diabetes (+560 deaths). For the estimation of the avoided death with
310 higher MPF consumption, main explaining factors of the model were the higher consumption
311 of fruits and vegetables and the lower consumption of processed meats. For the estimation
312 of the excess death with higher PF consumption, main explaining factors of the model were
313 the lower consumption of nuts and seeds, the higher consumption of sodium and a higher
314 energy intake, whereas for excess death with higher UPF consumption, main explaining
315 factors of the model were the lower consumption of vegetables and the higher consumption
316 of processed meats and sugar-sweetened beverages (Supplementary Table S7).

317

318 **Fig. 3** Estimation of potentially avoided or added cardiometabolic deaths (\pm 95% CI) when
319 shifting from first to third tertile of MPFp (proportion of total energy intake from
320 unprocessed/minimally processed foods), PFp (proportion of total energy intake from
321 processed foods) and UPFp (proportion of total energy intake from ultra-processed food, as
322 predicted by the EpiDiet (Evaluate the Potential Impact of a Diet), compared to the number of
323 deaths of the French adult population (the percentage corresponds to the percentage of
324 death added (if positive) or avoided (if negative))

325

326 **Discussion**

327 This study has shown that consumption of MPF was associated with total and animal protein
328 intakes and diet quality; consumption of PF was associated with under-diversified plant
329 protein intake and inversely with diet quality; and consumption of UPF was inversely
330 associated with total protein intake and diet quality. Most associations between the degree of
331 food processing and diet quality were attenuated when adjusting for total protein intake and
332 plant protein diversity.

333 The sociodemographic characteristics of people consuming high proportions of MPF and PF
334 in their diet had many similarities and both appeared to contrast with those of individuals
335 eating a high proportion of UPF. Similar sociodemographic profiles for high consumers of
336 MPF had been found in a study in the UK, where women and older people had a higher
337 percentage of energy intake from MPF [51]. The fact that younger adults and people in lower
338 socioeconomic groups consume more UPF has been reported in previous studies [52–54].
339 This can be taken as an illustration of the continuing shift from traditional diets towards a
340 western diet that is rendered uniform by ultra-processed foods [55].

341 The degree of food processing was associated with the plant/animal protein pattern. A higher
342 consumption of MPF meant higher intakes of total protein mostly as animal protein. This
343 could be expected inasmuch as the main food groups contributing to animal-based proteins

344 are classified as unprocessed/minimally processed foods such as poultry, red meat, fish,
345 yogurt and milk. With a higher PF consumption, intakes of plant protein were higher, and this
346 could be almost fully ascribed to a much higher intake of bread, under a general pattern that
347 may be referred to as traditional [56, 57]. Indeed, in high PF consumers, 62% of plant protein
348 came from refined grains, which explains why a higher consumption of processed foods was
349 associated with a poorer plant protein diversity, in contrast with high consumers of MPF who
350 had a more diverse plant protein intake. High consumers of UPF had lower protein intakes,
351 as reported in previous studies [51, 58, 59], this could be ascribed to a lower consumption of
352 protein food groups and higher intake of more miscellaneous food groups low in protein such
353 as sweet beverages, pastries or confectionery.

354 This study provides a fairly comprehensive view of the relationship between the degree of
355 food processing and diet quality. Higher consumers of MPF had greater nutrient adequacy,
356 higher healthful PDI, lower unhealthful PDI, and a lower predicted risk of death from
357 cardiometabolic diseases, whereas the opposite applied among higher consumers of UPF.
358 The results using substitution models clearly showed that substituting MPF by PF or UPF
359 had a detrimental effect on diet quality.

360 In another French population, poorer compliance with dietary guidelines was found in the
361 highest quartile of ultra-processed food consumers [52]. This association had also been
362 found in the US population where overall dietary quality was measured using a nutrient
363 balanced-pattern PCA-derived factor score [59]. The consumption of UPF has been
364 associated with excessive sugar intake [60] and with lower intakes of vitamins and minerals
365 [58], although this might depend on the level of usage of fortification in the food industry.
366 Regarding long-term health effects of consumption of UPF, our assessment of changes in
367 mortality rates from cardiovascular diseases are in line with findings in the literature,
368 inasmuch as a higher consumption of ultra-processed foods has been associated with a
369 higher risk of all-cause mortality of 31% in the USA [25] and 44% in Spain [24]. Among UK
370 adults, a higher consumption of UPF has also been associated with a higher risk of obesity

371 [61]. While the literature regarding UPF consumption has been growing, characterizing diet
372 quality and the health impact of consuming MPF have been overlooked and the data are
373 scarce [51]. However, it should be noted that a high consumption of MPF is ubiquitous in
374 traditional reference diets such as the Mediterranean diet which has proven health benefits
375 [62].

376 In our study, using comparative risk assessment on the diets, we estimated higher deaths
377 from cardiovascular diseases with higher consumption of UPF or PF, and lower deaths with
378 higher consumption of MPF. We were able to identify nutritional factors that contributed to
379 estimates of avoided or added death. Differences in BMI and energy intake were important
380 factors for high consumers of MPF and PF, although less than nutritional factors, but they
381 were more secondary for high consumers of UPF. Estimations of deaths from high
382 consumption of UPF are therefore poorly attributable to energy intake and BMI but to other
383 nutritional factors. High consumers of MPF have a dietary pattern that is known to be
384 associated with lower risk of cardiovascular diseases (fruits, vegetables, nuts, but also fish
385 and dairy) whereas high consumers of PF and UPF consumed more food groups known to
386 be associated with higher risk of cardiovascular diseases (refined grains, products rich in
387 sodium, alcohol, sugar-sweetened beverages, etc.) [63, 64]. Furthermore, adherence to
388 overall plant-based diet index (PDI) have been associated with a lower risk of cardiovascular
389 disease, cardiovascular disease mortality and all-cause mortality [65], which is consistent
390 with our findings since PDI only increased with higher share of MPF, where lower estimates
391 of death from cardiovascular diseases were observed. Using modelling analysis to predict
392 the impact of sustainable diets strategies on health, a study found that adopting diets that are
393 more plant-based would decrease mortality up to 12% [66]. The methodological framework
394 used in this study was similar to the Epidiet model that we used, although we included more
395 nutritional factors (24 instead of 9) and only focused on mortality from three diseases.

396 Beyond showing the association between the degree of processing of the foods consumed
397 and diet quality, the major new finding of this study was that the specific profiles of protein

398 consumption associated with these patterns are an important determinant of the relationship
399 with diet quality. In particular, the association between the proportion of MPF and most diet
400 quality criteria were attenuated when adjusting for protein intake and plant protein diversity.
401 Likewise, the relationships between the proportions of PF and UPF and nutrient adequacy
402 were attenuated or inversed when adjusting for protein intake and plant protein diversity.

403 Indeed, protein intake is an important determinant of diet quality and this is closely
404 dependent on the type of protein food consumed [13, 56, 67]. Plant protein intake and plant-
405 based diets are generally considered as healthy but there are some unhealthful versions of
406 plant-based diets [15, 16]. This may explain why in our study the consumption of processed
407 foods was associated with lower dietary quality even though it is accompanied by a higher
408 intake of plant protein. Plant protein consumed in high consumers of processed foods, mostly
409 refined grains, may not be an important contributor to diet quality, compared to other sources
410 such as legumes, nuts and seeds, and plant protein diversity appears as a condition for a
411 beneficial effect of plant protein, confirming our earlier report [33].

412 We believe that our present findings lend further credence to this viewpoint by showing that
413 the relationship between patterns of food processing and diet quality are in part linked to the
414 pattern of plant/animal protein intake. People with a high consumption of MPF have a higher
415 animal protein intake but this comes from raw sources, and they have a better diversity of
416 plant protein intake, all of which explain better diet quality. People with a high consumption of
417 PF would have a better diet quality if the increase in plant protein intake were not at the
418 expense of its diversity [33]. People with a high consumption of UPF have a lower intake of
419 protein foods, a lower plant:animal protein intake and are reliant on diverse ultra-processed
420 foods which taken together have a detrimental effect on their diet quality.

421 More and more consumers are prone to shift towards a more plant-based diet [68, 69], but
422 this occurs in the context of a food offer that is increasingly dominated by processed and
423 ultra-processed foods which exert an adverse effect on diet quality. This plant-based shift
424 may contribute to improving some aspects of sustainability such as the environmental impact

425 of the diet, but the final impact on its quality and on health outcomes will depend to a great
426 extent on the composition of the plant-based foods and overall diet consumed. Our study has
427 highlighted two possible better pathways, which consist in either increasing the consumption
428 of MPF, preferably with a higher plant protein intake, or choosing processed foods that
429 contribute to an increase in the proportion of plant proteins while maintaining plant protein
430 diversity and enabling the favorable nutrient package traditionally associated with plant
431 proteins.

432 ***Limitations of the study***

433 One limitation of this study may concern our use of the NOVA classification, where the ultra-
434 processed foods group is very broad and includes markedly differing foods that have been
435 ascribed to this group for different reasons (presence of additives or highly technological food
436 processing). Some food items are also classified according to their method of preparation,
437 requiring imputations that could be questionable (i.e. systematically considering foods from
438 fast-food restaurant as industrially processed). However, the NOVA classification has been
439 largely employed in the literature and its use offers a clear reference when discussing our
440 results. Another limitation concerns our food composition database. Indeed, a food item with
441 the same overall label was assigned to different NOVA categories depending on its origin
442 despite there being a lack of data regarding its composition. Regarding the study size and
443 generalizability, the present study took advantage of a representative setting in a country
444 with western dietary patterns and an important share of industrial foods, with a diversity of
445 patterns. High consumers of MPF and UPF appear to have dietary patterns comparable to
446 those reported in studies using other samples. High consumers of PF, which represent a
447 more traditional pattern might be less generalizable, but data are lacking for further analysis
448 since this NOVA category has been much less studied. Lastly, although the data came from
449 the latest French national representative survey (in 2014-2015), they may not have been
450 sufficiently recent to reflect current dietary transitions and the increased use of plant-based
451 products.

452 Conclusion

453 Although the consumption of UPF has been widely studied in recent years, to our knowledge
454 very few studies have investigated the associations between the consumption of MPF, PF
455 and diet quality. Using a variety of indices, we found that the consumption of MPF was
456 associated with higher diet quality whereas the opposite trend was found with consumption
457 of UPF. We also show that protein consumption patterns differed according to the degree of
458 food processing, and that it explains part of the associations with diet quality. Higher
459 consumers of MPF had a higher protein intake, with a lower plant:animal protein ratio, but
460 they had a healthier plant-based protein intake and a fully favorable dietary pattern. Higher
461 consumers of PF had higher plant protein intakes but lower plant protein diversity, and a
462 greater risk of cardiometabolic death. Higher consumers of UPF had a lower protein intake
463 and poor diet quality on all dimensions, including a markedly higher cardiometabolic risk. We
464 can thus conclude that healthy plant protein patterns are crucial to a future shift in protein
465 intake in the context of a food system that is increasingly dominated by ultra-processed
466 foods.

References

1. Monteiro CA, Cannon G, Levy R, et al (2016) NOVA. The star shines bright. [Food classification Puclib health] *World Nutrition* 7:28–38
2. Monteiro CA, Cannon G, Levy RB, et al (2019) Ultra-processed foods: what they are and how to identify them. *Public Health Nutr* 22:936–941. <https://doi.org/10.1017/S1368980018003762>
3. Martínez Steele E, Baraldi LG, Louzada ML da C, et al (2016) Ultra-processed foods and added sugars in the US diet: evidence from a nationally representative cross-sectional study. *BMJ Open* 6:e009892. <https://doi.org/10.1136/bmjopen-2015-009892>
4. Rauber F, da Costa Louzada ML, Steele E, et al (2018) Ultra-Processed Food Consumption and Chronic Non-Communicable Diseases-Related Dietary Nutrient Profile in the UK (2008–2014). *Nutrients* 10:587. <https://doi.org/10.3390/nu10050587>
5. Monteiro CA, Moubarac J-C, Cannon G, et al (2013) Ultra-processed products are becoming dominant in the global food system: Ultra-processed products: global dominance. *Obes Rev* 14:21–28. <https://doi.org/10.1111/obr.12107>
6. Monteiro CA, Cannon G, Moubarac J-C, et al (2018) The UN Decade of Nutrition, the NOVA food classification and the trouble with ultra-processing. *Public Health Nutr* 21:5–17. <https://doi.org/10.1017/S1368980017000234>
7. Martínez Steele E, Raubenheimer D, Simpson SJ, et al (2018) Ultra-processed foods, protein leverage and energy intake in the USA. *Public Health Nutr* 21:114–124. <https://doi.org/10.1017/S1368980017001574>
8. Gerber PJ, Food and Agriculture Organization of the United Nations (2013) Tackling climate change through livestock: a global assessment of emissions and mitigation opportunities. Food and Agriculture Organization of the United Nations, Rome
9. Wu G, Fanzo J, Miller DD, et al (2014) Production and supply of high-quality food protein for human consumption: sustainability, challenges, and innovations: Sustainability, challenge and innovations. *Ann NY Acad Sci* 1321:1–19. <https://doi.org/10.1111/nyas.12500>
10. Springmann M, Clark M, Mason-D’Croz D, et al (2018) Options for keeping the food system within environmental limits. *Nature* 562:519–525. <https://doi.org/10.1038/s41586-018-0594-0>
11. Willett W, Rockström J, Loken B, et al (2019) Food in the Anthropocene: the EAT–Lancet Commission on healthy diets from sustainable food systems. *The Lancet* 393:447–492. [https://doi.org/10.1016/S0140-6736\(18\)31788-4](https://doi.org/10.1016/S0140-6736(18)31788-4)
12. World Cancer Research Fund, American Institute for Cancer Research. (2018) Diet, nutrition, physical activity and cancer: a global perspective. The third Expert Report
13. Mariotti F (2019) Animal and Plant Protein Sources and Cardiometabolic Health. *Adv Nutr* 10:S351–S366. <https://doi.org/10.1093/advances/nmy110>
14. Song M, Fung TT, Hu FB, et al (2016) Association of Animal and Plant Protein Intake With All-Cause and Cause-Specific Mortality. *JAMA Intern Med* 176:1453. <https://doi.org/10.1001/jamainternmed.2016.4182>

15. Satija A, Bhupathiraju SN, Spiegelman D, et al (2017) Healthful and Unhealthful Plant-Based Diets and the Risk of Coronary Heart Disease in U.S. Adults. *J Am Coll Cardiol* 70:411–422. <https://doi.org/10.1016/j.jacc.2017.05.047>
16. Satija A, Bhupathiraju SN, Rimm EB, et al (2016) Plant-Based Dietary Patterns and Incidence of Type 2 Diabetes in US Men and Women: Results from Three Prospective Cohort Studies. *PLoS Med* 13:e1002039. <https://doi.org/10.1371/journal.pmed.1002039>
17. Gehring J, Touvier M, Baudry J, et al (2020) Consumption of Ultra-Processed Foods by Pesco-Vegetarians, Vegetarians, and Vegans: Associations with Duration and Age at Diet Initiation. *J Nutr* nxaa196. <https://doi.org/10.1093/jn/nxaa196>
18. Moodie R, Stuckler D, Monteiro C, et al (2013) Profits and pandemics: prevention of harmful effects of tobacco, alcohol, and ultra-processed food and drink industries. *The Lancet* 381:670–679. [https://doi.org/10.1016/S0140-6736\(12\)62089-3](https://doi.org/10.1016/S0140-6736(12)62089-3)
19. Vandevijvere S, Jaacks LM, Monteiro CA, et al (2019) Global trends in ultraprocessed food and drink product sales and their association with adult body mass index trajectories. *Obesity Reviews* 20:10–19. <https://doi.org/10.1111/obr.12860>
20. Monteiro CA, Cannon G, Lawrence M, et al (2019) Ultra-processed foods, diet quality, and health using the NOVA classification system. *FAO, Rome*
21. Fiolet T, Srour B, Sellem L, et al (2018) Consumption of ultra-processed foods and cancer risk: results from NutriNet-Santé prospective cohort. *BMJ* k322. <https://doi.org/10.1136/bmj.k322>
22. Mendonça R de D, Lopes ACS, Pimenta AM, et al (2016) Ultra-Processed Food Consumption and the Incidence of Hypertension in a Mediterranean Cohort: The Seguimiento Universidad de Navarra Project. *AJHYPE* hpw137. <https://doi.org/10.1093/ajh/hpw137>
23. Nardocci M, Leclerc B-S, Louzada M-L, et al (2019) Consumption of ultra-processed foods and obesity in Canada. *Can J Public Health* 110:4–14. <https://doi.org/10.17269/s41997-018-0130-x>
24. Blanco-Rojo R, Sandoval-Insausti H, López-García E, et al (2019) Consumption of Ultra-Processed Foods and Mortality: A National Prospective Cohort in Spain. *Mayo Clinic Proceedings* 94:2178–2188. <https://doi.org/10.1016/j.mayocp.2019.03.035>
25. Kim H, Hu EA, Rebholz CM (2019) Ultra-processed food intake and mortality in the USA: results from the Third National Health and Nutrition Examination Survey (NHANES III, 1988–1994). *Public Health Nutr* 22:1777–1785. <https://doi.org/10.1017/S1368980018003890>
26. Hall KD, Ayuketah A, Brychta R, et al (2019) Ultra-Processed Diets Cause Excess Calorie Intake and Weight Gain: An Inpatient Randomized Controlled Trial of Ad Libitum Food Intake. *Cell Metabolism* 30:67-77.e3. <https://doi.org/10.1016/j.cmet.2019.05.008>
27. (2017) Opinion of the French Agency for Food, Environmental and Occupational Health & Safety on “the Third Individual and National Survey on Food Consumption (INCA3 Survey).” French Agency for Food, Environmental and Occupational Health Safety (Anses).
28. Dubuisson C, Dufour A, Carrillo S, et al (2019) The Third French Individual and National Food Consumption (INCA3) Survey 2014–2015: method, design and participation rate

- in the framework of a European harmonization process. *Public Health Nutr* 22:584–600. <https://doi.org/10.1017/S1368980018002896>
29. Henry C (2005) Basal metabolic rate studies in humans: measurement and development of new equations. *Public Health Nutr* 8:1133–1152. <https://doi.org/10.1079/PHN2005801>
 30. Black A (2000) Critical evaluation of energy intake using the Goldberg cut-off for energy intake: basal metabolic rate. A practical guide to its calculation, use and limitations. *Int J Obes* 24:1119–1130. <https://doi.org/10.1038/sj.ijo.0801376>
 31. Slimani N, Freisling H, Huybrechts I, et al (2013) Food Consumption Data Collection Methodology for the EU Menu Survey (EMP-PANEU) Final Report. EFSA supporting publication
 32. French Agency for Food, Environmental and Occupational Health & Safety (2016) ANSES-CIQUAL French food composition table version 2016
 33. Salomé M, de Gavelle E, Dufour A, et al (2019) Plant-Protein Diversity Is Critical to Ensuring the Nutritional Adequacy of Diets When Replacing Animal With Plant Protein: Observed and Modeled Diets of French Adults (INCA3). *J Nutr* nxz252. <https://doi.org/10.1093/jn/nxz252>
 34. Drescher LS, Thiele S, Mensink GBM (2007) A New Index to Measure Healthy Food Diversity Better Reflects a Healthy Diet Than Traditional Measures. *The Journal of Nutrition* 137:647–651. <https://doi.org/10.1093/jn/137.3.647>
 35. de Oliveira Otto MC, Padhye NS, Bertoni AG, et al (2015) Everything in Moderation - Dietary Diversity and Quality, Central Obesity and Risk of Diabetes. *PLoS ONE* 10:e0141341. <https://doi.org/10.1371/journal.pone.0141341>
 36. Verger EO, Mariotti F, Holmes BA, et al (2012) Evaluation of a Diet Quality Index Based on the Probability of Adequate Nutrient Intake (PANDiet) Using National French and US Dietary Surveys. *PLoS ONE* 7:e42155. <https://doi.org/10.1371/journal.pone.0042155>
 37. de Gavelle E, Huneau J-F, Foullet H, Mariotti F (2019) The Initial Dietary Pattern Should Be Considered when Changing Protein Food Portion Sizes to Increase Nutrient Adequacy in French Adults. *The Journal of Nutrition* 149:488–496. <https://doi.org/10.1093/jn/nxy275>
 38. Anses (2016) Actualisation des repères du PNNS : élaboration des références nutritionnelles. French Agency for Food, Environmental and Occupational Health Safety (Anses)., Maisons-Alfort, France
 39. Anses (2019) Anses Opinion on the updating of the PNNS dietary guidelines for women from menopause and men over 65 years of age. French Agency for Food, Environmental and Occupational Health Safety (Anses)., Maisons-Alfort, France
 40. Murray CJL, Lopez AD (2013) Measuring the Global Burden of Disease. *N Engl J Med* 369:448–457. <https://doi.org/10.1056/NEJMra1201534>
 41. Kesse-Guyot E, Chaltiel D, Wang J, et al (2020) Sustainability analysis of French dietary guidelines using multiple criteria. *Nat Sustain* 3:377–385. <https://doi.org/10.1038/s41893-020-0495-8>

42. Aune D, Giovannucci E, Boffetta P, et al (2017) Fruit and vegetable intake and the risk of cardiovascular disease, total cancer and all-cause mortality—a systematic review and dose-response meta-analysis of prospective studies. *International Journal of Epidemiology* 46:1029–1056. <https://doi.org/10.1093/ije/dyw319>
43. Micha R, Peñalvo JL, Cudhea F, et al (2017) Association Between Dietary Factors and Mortality From Heart Disease, Stroke, and Type 2 Diabetes in the United States. *JAMA* 317:912. <https://doi.org/10.1001/jama.2017.0947>
44. Scarborough P, Harrington RA, Mizdrak A, et al (2014) The Preventable Risk Integrated ModEl and Its Use to Estimate the Health Impact of Public Health Policy Scenarios. *Scientifica* 2014:1–21. <https://doi.org/10.1155/2014/748750>
45. Inserm CépiDC Classification internationale des maladies (CIM). In: CépiDC Internet. <https://www.cephdc.inserm.fr/causes-medicales-de-deces/classification-internationale-des-maladies-cim>. Accessed 26 Feb 2019
46. Insee Évolution et structure de la population en 2014. In: Insee Internet. <https://www.insee.fr/fr/statistiques/2862200>. Accessed 26 Feb 2019
47. CépiDc (2019) Causes Médicales des Décès en 2014. <https://www.cephdc.inserm.fr/causes-medicales-de-deces/interroger-les-donnees-de-mortalite> . Accessed 26 Feb 2019
48. Thiébaud A, Kesse E, Com-Nougé C, et al (2004) Ajustement sur l'apport énergétique dans l'évaluation des facteurs de risque alimentaires. *Revue d'Épidémiologie et de Santé Publique* 52:539–557. [https://doi.org/10.1016/S0398-7620\(04\)99093-1](https://doi.org/10.1016/S0398-7620(04)99093-1)
49. Willett WC, Howe GR, Kushi LH (1997) Adjustment for total energy intake in epidemiologic studies. *The American Journal of Clinical Nutrition* 65:1220S-1228S. <https://doi.org/10.1093/ajcn/65.4.1220S>
50. Saltelli A, Ratto M, Andres T, et al (2008) *Global Sensitivity Analysis: The Primer*. John Wiley & Sons, Chichester
51. Adams J, White M (2015) Characterisation of UK diets according to degree of food processing and associations with socio-demographics and obesity: cross-sectional analysis of UK National Diet and Nutrition Survey (2008–12). *Int J Behav Nutr Phys Act* 12:160. <https://doi.org/10.1186/s12966-015-0317-y>
52. Julia C, Martinez L, Allès B, et al (2018) Contribution of ultra-processed foods in the diet of adults from the French NutriNet-Santé study. *Public Health Nutr* 21:27–37. <https://doi.org/10.1017/S1368980017001367>
53. Baraldi LG, Martinez Steele E, Canella DS, Monteiro CA (2018) Consumption of ultra-processed foods and associated sociodemographic factors in the USA between 2007 and 2012: evidence from a nationally representative cross-sectional study. *BMJ Open* 8:e020574. <https://doi.org/10.1136/bmjopen-2017-020574>
54. Machado PP, Steele EM, Louzada ML da C, et al (2019) Ultra-processed food consumption drives excessive free sugar intake among all age groups in Australia. *Eur J Nutr*. <https://doi.org/10.1007/s00394-019-02125-y>

55. Baker P, Machado P, Santos T, et al (2020) Ultra-processed foods and the nutrition transition: Global, regional and national trends, food systems transformations and political economy drivers. *Obesity Reviews* 21:. <https://doi.org/10.1111/obr.13126>
56. de Gavelle E, Huneau J-F, Mariotti F (2018) Patterns of Protein Food Intake Are Associated with Nutrient Adequacy in the General French Adult Population. *Nutrients* 10:226. <https://doi.org/10.3390/nu10020226>
57. Gazan R, Béchaux C, Crépet A, et al (2016) Dietary patterns in the French adult population: a study from the second French national cross-sectional dietary survey (INCA2) (2006–2007). *Br J Nutr* 116:300–315. <https://doi.org/10.1017/S0007114516001549>
58. Louzada ML da C, Ricardo CZ, Steele EM, et al (2018) The share of ultra-processed foods determines the overall nutritional quality of diets in Brazil. *Public Health Nutr* 21:94–102. <https://doi.org/10.1017/S1368980017001434>
59. Martínez Steele E, Popkin BM, Swinburn B, Monteiro CA (2017) The share of ultra-processed foods and the overall nutritional quality of diets in the US: evidence from a nationally representative cross-sectional study. *Popul Health Metrics* 15:6. <https://doi.org/10.1186/s12963-017-0119-3>
60. Rauber F, Louzada ML da C, Martinez Steele E, et al (2019) Ultra-processed foods and excessive free sugar intake in the UK: a nationally representative cross-sectional study. *BMJ Open* 9:e027546. <https://doi.org/10.1136/bmjopen-2018-027546>
61. Rauber F, Chang K, Vamos EP, et al (2020) Ultra-processed food consumption and risk of obesity: a prospective cohort study of UK Biobank. *Eur J Nutr*. <https://doi.org/10.1007/s00394-020-02367-1>
62. Salas-Salvadó J, Becerra-Tomás N, García-Gavilán JF, et al (2018) Mediterranean Diet and Cardiovascular Disease Prevention: What Do We Know? *Prog Cardiovasc Dis* 61:62–67. <https://doi.org/10.1016/j.pcad.2018.04.006>
63. Anand SS (2015) Food Consumption and its Impact on Cardiovascular Disease: Importance of Solutions Focused on the Globalized Food System: A Report From the Workshop Convened by the World Heart Federation. *Cardiovascular Disease* 66:25
64. Petersen KS, Flock MR, Richter CK, et al (2017) Healthy Dietary Patterns for Preventing Cardiometabolic Disease: The Role of Plant-Based Foods and Animal Products. *Curr Dev Nutr* 1:cdn.117.001289. <https://doi.org/10.3945/cdn.117.001289>
65. Kim H, Caulfield LE, Garcia-Larsen V, et al (2019) Plant-Based Diets Are Associated With a Lower Risk of Incident Cardiovascular Disease, Cardiovascular Disease Mortality, and All-Cause Mortality in a General Population of Middle-Aged Adults. *JAHA* 8:. <https://doi.org/10.1161/JAHA.119.012865>
66. Springmann M, Wiebe K, Mason-D’Croz D, et al (2018) Health and nutritional aspects of sustainable diet strategies and their association with environmental impacts: a global modelling analysis with country-level detail. *The Lancet Planetary Health* 2:e451–e461. [https://doi.org/10.1016/S2542-5196\(18\)30206-7](https://doi.org/10.1016/S2542-5196(18)30206-7)
67. Tian S, Xu Q, Jiang R, et al (2017) Dietary Protein Consumption and the Risk of Type 2 Diabetes: A Systematic Review and Meta-Analysis of Cohort Studies. *Nutrients* 9:982. <https://doi.org/10.3390/nu9090982>

68. Sanchez-Sabate R, Badilla-Briones Y, Sabaté J (2019) Understanding Attitudes towards Reducing Meat Consumption for Environmental Reasons. A Qualitative Synthesis Review. *Sustainability* 11:6295. <https://doi.org/10.3390/su11226295>
69. Malek L, Umberger WJ, Goddard E (2019) Committed vs. uncommitted meat eaters: Understanding willingness to change protein consumption. *Appetite* 138:115–126. <https://doi.org/10.1016/j.appet.2019.03.024>

Table 1 Estimated effect of substituting unprocessed/minimally processed foods (MPF) with processed culinary ingredients, processed foods (PF) or ultra-processed foods (UPF) on the PANDiet, hPDI and uPDI diet quality scores under a mutually adjusted multivariate substitution model^a.

	PANDiet		hPDI		uPDI	
	β (95% CI)	<i>P</i>	β (95% CI)	<i>P</i>	β (95% CI)	<i>P</i>
Proportion of total energy intake from PF ^b	-0.11 (-0.14, -0.09)	<0.001	0.00 (-0.03, 0.03)	0.871	0.12 (0.09, 0.16)	<0.001
Proportion of total energy intake from UPF ^b	-0.16 (-0.19, -0.14)	<0.001	-0.05 (-0.08, -0.03)	<0.001	0.13 (0.10, 0.16)	<0.001

^aData from the Individual and National Study on Food Consumption Survey 3, n=1774. Values are regression coefficients (95% CIs) estimated with multiple linear regressions. Data were collected by three 24h recalls.

^bModel where the proportion of processed culinary ingredients, PF and UPF in the diet were included for mutual adjustment. The proportion of MPF was not included since it was taken as a reference for substitution. The model was adjusted for total energy intake, age, sex, educational level, occupational status, city size, perception of financial status, season of record, region of France and matrimonial status. The association with the proportion of processed culinary ingredients in the diet is not presented since it seems unlikely to substitute foods with culinary ingredients.

hPDI, healthy Plant-based Diet Index; NS, non-significant; PANDiet, Probability of Adequate Nutrient Intake in the Diet; PF, processed foods; uPDI, unhealthy Plant-based diet Index; UPF, ultra-processed foods.

Table 2 Associations between the PANDiet, hPDI and uPDI diet quality scores and variables of the NOVA classification (proportion of total energy intake from unprocessed/minimally processed foods (MPF), processed foods (PF) and ultra-processed foods (UPF)) using multivariate models adjusted for the characteristics of protein intake, in the French adult population^a.

	PANDiet		hPDI		uPDI	
	β (95% CI)	<i>P</i>	β (95% CI)	<i>P</i>	β (95% CI)	<i>P</i>
Proportion of total energy intake from MPF						
Basic model ^b	0.14 (0.12, 0.16)	<0.001	0.04 (0.01, 0.06)	0.003	-0.13 (-0.15, -0.10)	<0.001
Controlling for protein intake ^c	0.10 (0.08, 0.12)	<0.001	0.06 (0.03, 0.08)	<0.001	-0.10 (-0.13, -0.07)	<0.001
Controlling for BI-PBF ^d	0.12 (0.10, 0.14)	<0.001	0.00 (-0.03, 0.02)	0.850	-0.07 (-0.10, -0.04)	<0.001
Controlling for protein intake + BI-PBF ^e	0.07 (0.05, 0.09)	<0.001	0.00 (-0.02, 0.03)	0.771	-0.04 (-0.06, -0.01)	0.004
Proportion of total energy intake from PF						
Basic model ^b	0.02 (-0.02, 0.02)	0.965	0.02 (0.00, 0.05)	0.084	0.04 (0.02, 0.07)	0.002
Controlling for protein intake ^c	-0.08 (-0.11, -0.06)	<0.001	-0.03 (-0.05, 0.00)	0.045	0.06 (0.04, 0.09)	<0.001
Controlling for BI-PBF ^d	0.05 (0.03, 0.08)	<0.001	0.11 (0.08, 0.13)	<0.001	-0.07 (-0.10, -0.04)	<0.001
Controlling for protein intake + BI-PBF ^e	-0.04 (-0.06, -0.01)	0.002	0.06 (0.04, 0.09)	<0.001	-0.04 (-0.07, -0.01)	0.005
Proportion of total energy intake from UPF						
Basic model ^b	-0.05 (-0.07, -0.04)	<0.001	-0.07 (-0.09, -0.05)	<0.001	0.06 (0.04, 0.08)	<0.001
Controlling for protein intake ^c	-0.01 (-0.03, 0.00)	0.151	-0.05 (-0.07, -0.03)	<0.001	0.05 (0.03, 0.08)	<0.001
Controlling for BI-PBF ^d	-0.06 (-0.08, -0.05)	<0.001	-0.09 (-0.11, -0.07)	<0.001	0.08 (0.06, 0.10)	<0.001
Controlling for protein intake + BI-PBF ^e	-0.02 (-0.04, 0.00)	0.024	-0.06 (-0.08, -0.04)	<0.001	0.07 (0.05, 0.09)	<0.001

^aData from the Individual and National Study on Food Consumption Survey 3, n=1774. Values are regression coefficients (95% CIs) estimated with multiple linear regressions. Data were collected by three 24h recalls.

^bBasic model adjusted for total energy intake, age, sex, educational level, occupational status, city size, perception of financial status, season of record, region of France and matrimonial status.

^cBasic model further adjusted for animal protein and plant protein intakes, both being energy-adjusted using the residual method.

^dBasic model further adjusted for plant protein diversity, evaluated with the BI-PBF score.

^eBasic model further adjusted for animal protein and plant protein intakes and plant protein diversity (BI-PBF score).

BI-PBF, Berry-Index – Plant-based families; hPDI, healthy Plant-based Diet Index; MPF, unprocessed/minimally processed foods; NS, non-significant; PANDiet, Probability of Adequate Nutrient Intake; PF, processed foods; uPDI, unhealthy Plant-based diet Index; UPF, ultra-processed foods.

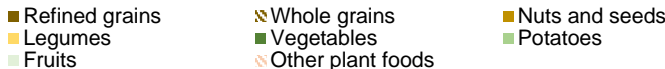
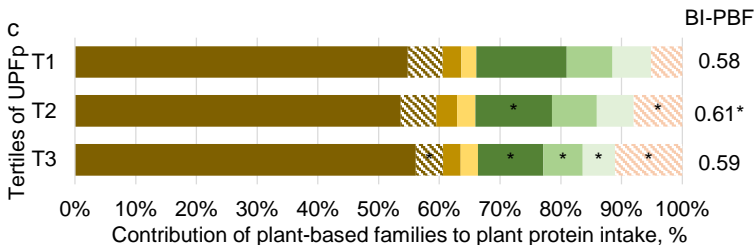
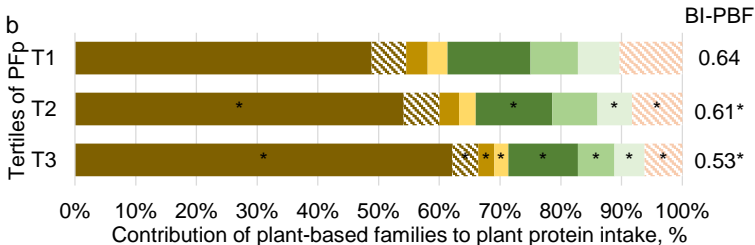
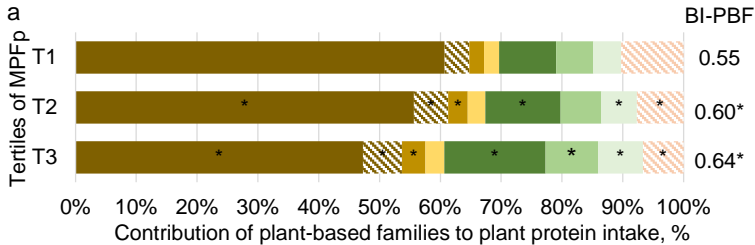

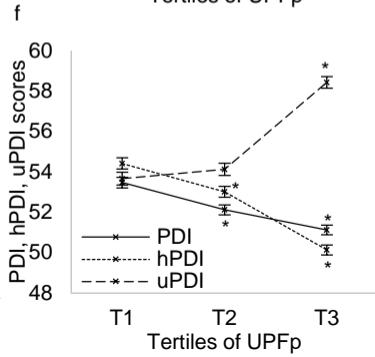
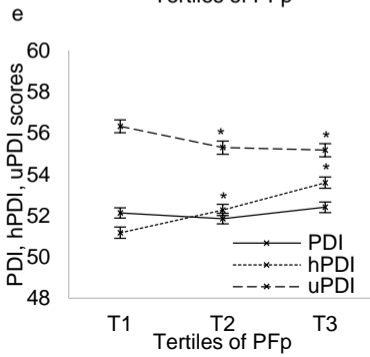
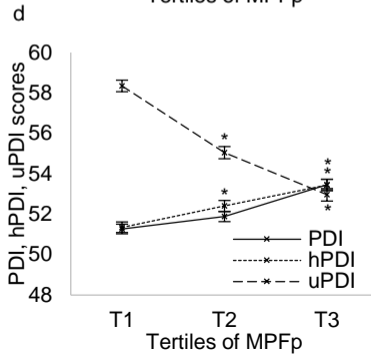
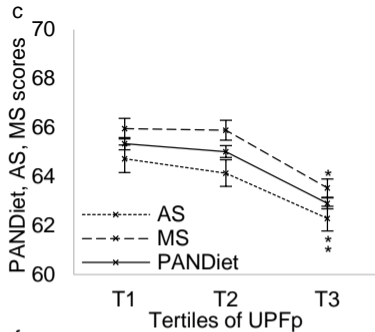
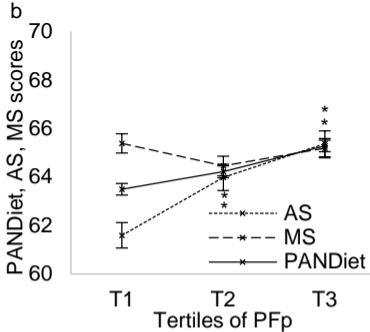
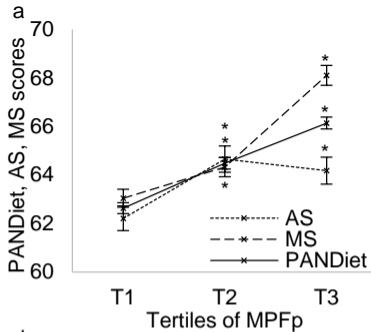

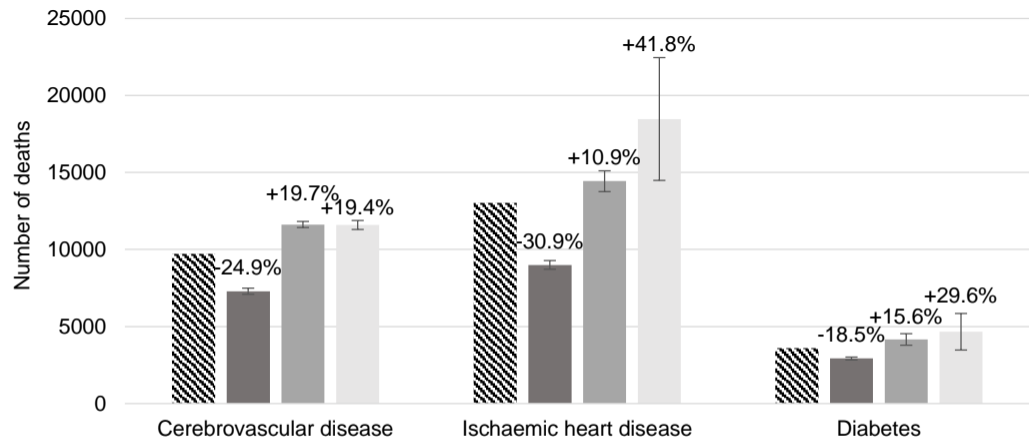

▨ Annual number of deaths observed in the French population
Estimated number of deaths from a simulated shift of the population's diet towards

- A higher share of total energy intake from MPF
- A higher share of total energy intake from PF
- A higher share of total energy intake from UPF

Contrary to ultra-processed foods, the consumption of unprocessed or minimally processed foods is associated with favorable patterns of protein intake, diet quality and lower cardiometabolic risk in French adults (INCA3).

Marion Salomé¹, Laura Arrazat¹, Juhui Wang¹, Ariane Dufour², Carine Dubuisson², Jean-Luc Volatier², Jean-François Huneau¹, François Mariotti^{1*}

¹Université Paris-Saclay, AgroParisTech, INRAE, UMR PNCA, 75005, Paris, France

²Risk Assessment Department, Methodology and Survey Unit, French Agency for Food, Environmental and Occupational Health & Safety (ANSES), 14 rue Pierre et Marie Curie, 94701 Maisons-Alfort Cedex, France

* Corresponding author: François Mariotti, 16 rue Claude Bernard, 75005 Paris, France, francois.mariotti@agroparistech.fr

Supplementary Table S1 Reference values of the PANDiet scoring system.

PANDiet score ¹			
Average of Adequacy and Moderation subscores			
Adequacy subscore			
Nutrient	Reference value (/day) ²	Variability	Source
Protein	0.66 or 0.8 g/kg bw	12.5%	[1]
LA	3.08% EIEA	15%	[3]
ALA	0.769% EIEA	15%	[3]
DHA	0.192 g	15%	[3]
EPA + DHA	0.385 g	15%	[3]
Fiber	23 g	15%	[2]
Vitamin A	570 or 490 µg	15%	[2]
Thiamin	0.3 mg/1000 kcal	20%	[4]
Riboflavin	1.3 mg	15%	[4]
Niacin	5.44 mg NE/1000kcal	10%	[2]
Pantothenic acid	3.62 or 2.94 mg	30%	[2]
Vitamin B-6	1.5 or 1.3 mg	10%	[5]
Folate	250 µg	15%	[2]
Vitamin B-12	3.33 µg	10%	[2]
Vitamin C	90 mg	10%	[2]
Vitamin D	10 µg	25%	[2]
Vitamin E	5.8 or 5.5 mg	40%	[2]
Calcium	860 (<= 24 y.o) or 750 (>24 y.o.)	15% or 13%	[2]
Copper	1.0 or 0.8 mg	15%	[2]
Iodine	107 µg	20%	[2]
Bioavailable iron	See formula in de Gavelle et al. (7)		[2]
Magnesium	5 mg/kg bw	15%	[2]
Manganese	1.56 or 1.39 mg	40%	[2]
Phosphorus	Calcium (mmol) / 1.65 c.f. phosphorus section in de Gavelle et al. [6]	7.5% + CV Calcium (mg)	[4]
Potassium	2692 mg	15%	[4]
Selenium	54 µg	15%	[2]
Bioavailable zinc	0.642 + 0.038 b.w.	10%	[2]

Moderation subscore			
Nutrient	Reference value (/day)	Variability	Source
Protein	2.2 g/kg bw	12.5%	[2]
Total fat	44% EIEA	5%	[2]
SFA	12% EIEA	15%	[2]
Carbohydrates	60.5% EIEA	5%	[2]
Sugars (without lactose)	100 g	15%	[2]
Sodium	3482 or 2618 mg	40%	[2]

Tolerable Upper Intake Limits		Source
Vitamin A (retinol only)	3000 µg	[2]
Niacin	900 mg	[2]
Vitamin B6	25 mg	[2]
Folate	1170 µg	[2]
Vitamin D	100 µg	[2]
Vitamin E	300 mg	[2]
Calcium	2500 mg	[2]
Copper	10 mg	[2]
Iodine	600 µg	[2]
Dissociable magnesium	250 mg	[2]
Selenium	300 µg	[2]
Zinc	25 mg	[2]

¹The PANDiet score is expressed as the average of an adequacy subscore (AS – accounting for 27 nutrients) and a moderation subscore (MS – accounting for six nutrients, plus 12 potential penalty values). DHA and EPA+DHA are weighted by a factor of 1/2 as DHA is present twice. Niacin equivalents were calculated as the sum of dietary niacin and 1/60 dietary tryptophan. The complete construction of the score has been described elsewhere [7, 8].

²The PANDiet 3.1 version is mainly based on the dietary reference intake from the 2016 Anses opinion [2]. PANDiet was modified from its previous version [8] in order to be used also in older adults [9]. According to ANSES opinion, the reference values for vitamins and minerals and the contribution of macronutrients to energy intake are similar to those of adults. Only protein intake should be higher (with a population reference intake of 1 g/kg/d vs 0.83 g/kg/d for younger adults). The reference value for proteins was therefore adapted for adults over the age of 65y.

ALA, alpha-linolenic acid; bw, body weight; CV, coefficient of variation; DHA, docosahexaenoic acid; EIEA, energy intake excluding alcohol; EPA, eicosapentaenoic acid; LA, linoleic acid; NE, niacin equivalent; SFA, saturated fatty acids.

Supplementary Table S2 Food groups used to calculate PDI scores, and scoring system, as proposed by Satija et al. [10, 11]

	Overall plant-based diet index (PDI) (18-90 points)	Healthy plant-based diet index (hPDI) (18-90 points)	Unhealthy plant-based diet index (uPDI) (18-90 points)
Plant Food Groups¹			
Healthy			
Whole grains	Positive scores ²	Positive scores	Reverse scores ³
Fruits	Positive scores	Positive scores	Reverse scores
Vegetables	Positive scores	Positive scores	Reverse scores
Nuts	Positive scores	Positive scores	Reverse scores
Legumes	Positive scores	Positive scores	Reverse scores
Vegetable oils	Positive scores	Positive scores	Reverse scores
Tea and coffee	Positive scores	Positive scores	Reverse scores
Less healthy			
Fruit juices	Positive scores	Reverse scores	Positive scores
Refined grains	Positive scores	Reverse scores	Positive scores
Potatoes	Positive scores	Reverse scores	Positive scores
Sugar sweetened beverages	Positive scores	Reverse scores	Positive scores
Sweets and desserts	Positive scores	Reverse scores	Positive scores
Animal Food Groups			
Animal fats	Reverse scores	Reverse scores	Reverse scores
Dairy	Reverse scores	Reverse scores	Reverse scores
Eggs	Reverse scores	Reverse scores	Reverse scores
Fish or seafood	Reverse scores	Reverse scores	Reverse scores
Meat	Reverse scores	Reverse scores	Reverse scores
Miscellaneous animal-based foods	Reverse scores	Reverse scores	Reverse scores

¹Each food item was attributed to a food group (mixed foods were broken down into ingredients which were then attributed to a food group). The mean quantity of each food group consumed each day per individual was worked out instead of the frequencies of consumption, because our data came from 24h recalls and not a FFQ, as was the case in the study by Satija et al. The consumption of each food group was stratified into quintiles among participants. For each food group, a score between 1 and 5 was applied.

²For positive scores, the highest scores were attributed to the individuals in the highest consumption quintiles (i.e. 5 points for the 5th quintile to 1 point for the 1st quintile).

³For reverse scores, individuals in the higher quintiles received fewer points than individuals in the lower quintiles (i.e. 1 point for the 5th quintile to 5 points for the 1st quintile).

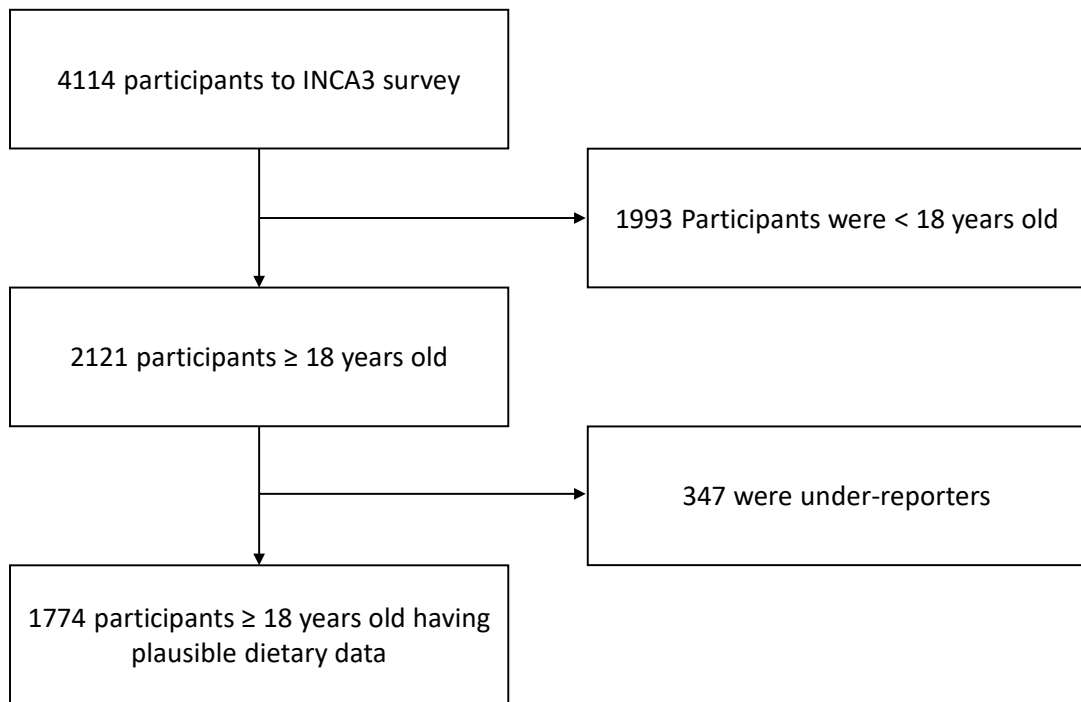

Supplementary Figure S1 Flow chart explaining the sampling of French participants from the third Individual and National Study on Food Consumption Survey (INCA3).

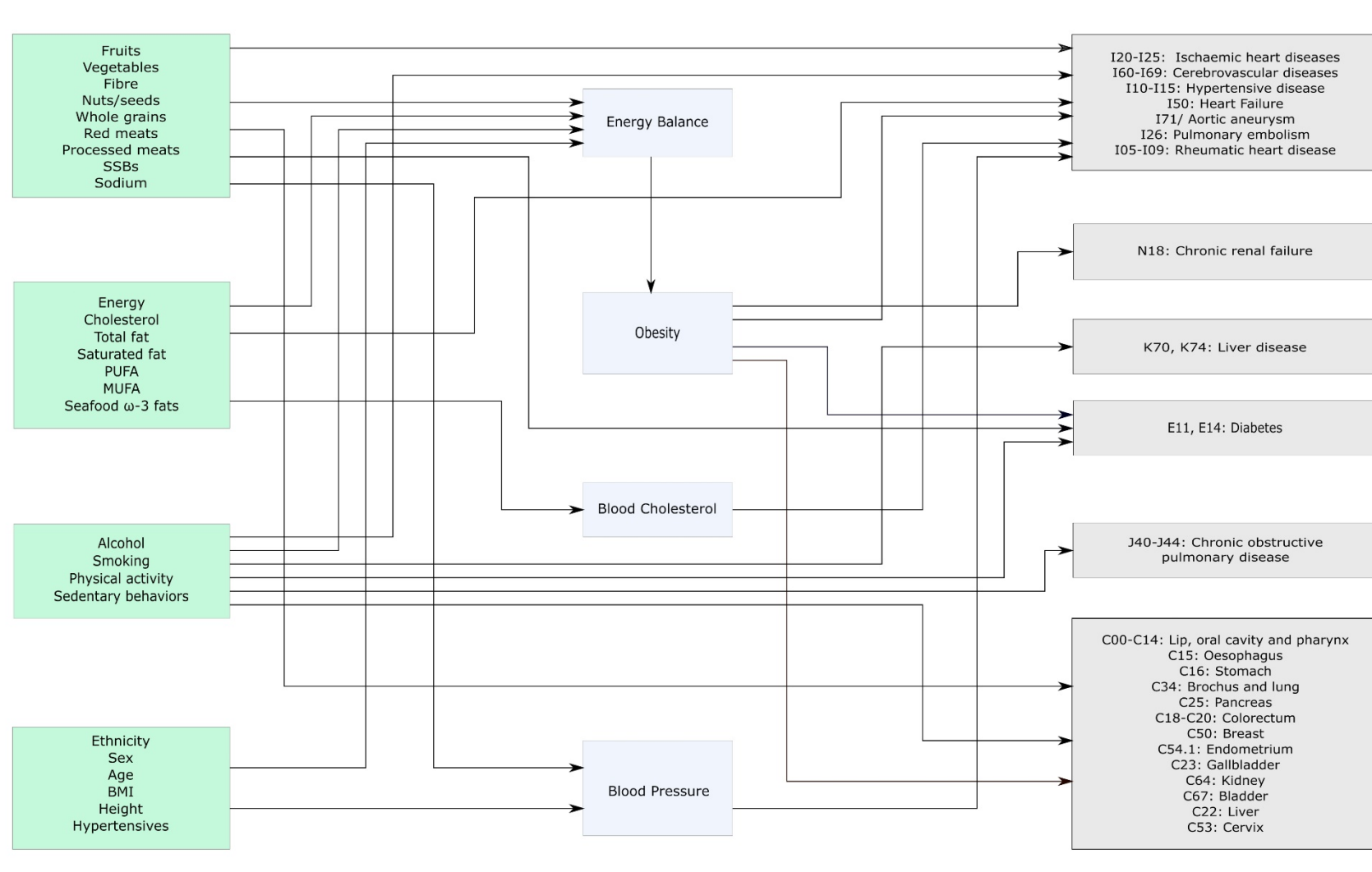

Supplementary Figure S2 A conceptual framework showing the relationship between the risk factors and the disease outcomes, implemented in the EpiDiet model. The left column lists the risk factors considered (foods, macro and micro-nutrients, behaviors and anthropometric measurements), and the right the diseases taken into account in the model. In the middle are listed the mechanistic or statistical models implemented in EpiDiet to formulate the hypotheses on the mediator factors.

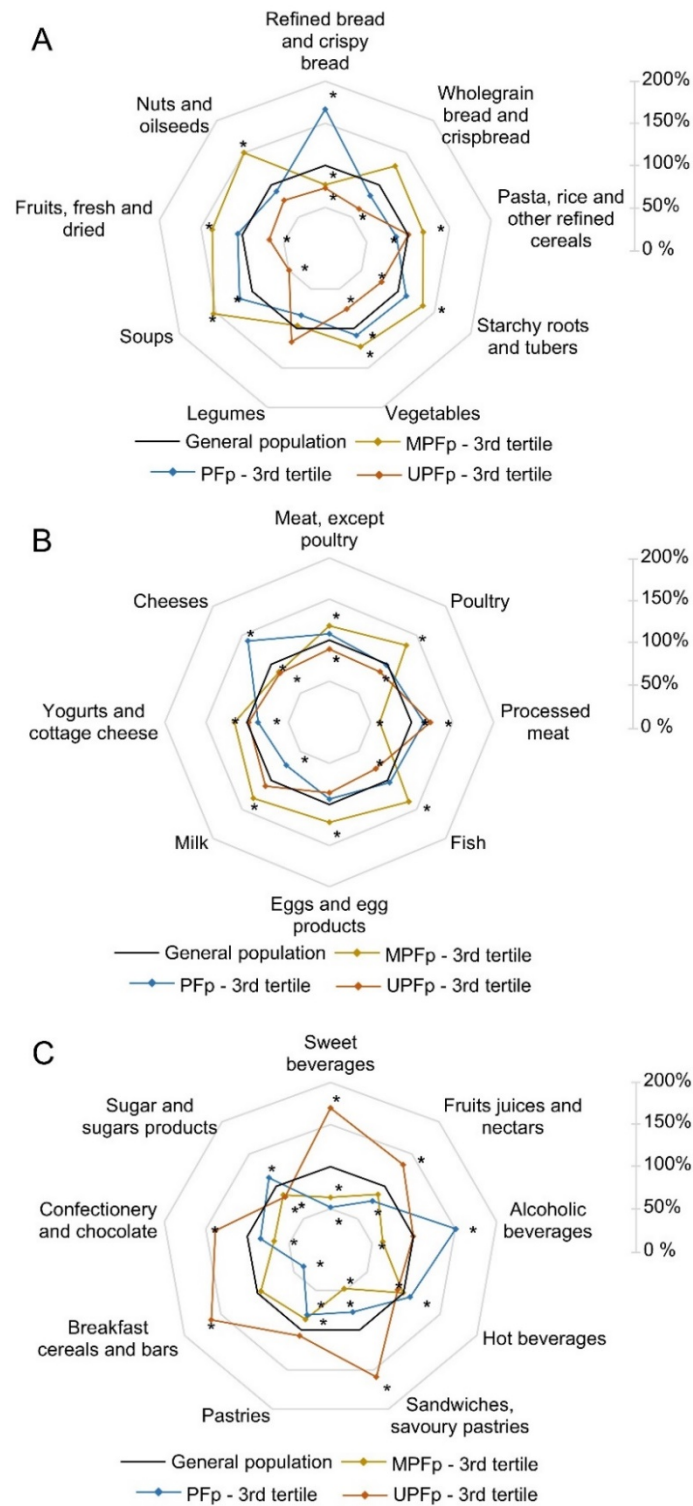

Supplementary Figure S3 Relative mean intake of A. Plant-based food groups, B. Animal-based food groups and C. Miscellaneous food groups in the third tertiles of the proportion of unprocessed/minimally processed foods in the diet (MPFp-3rd tertile, n=591), the proportion of processed foods in the diet (PFp-3rd tertile, n=591) and the proportion of ultra-processed foods in the diet (UPFp-3rd tertile, n=591) shown as a percentage compared to Is-mean intake in the INCA3 population (n=1774), taken as the reference at 100%. Means are adjusted for the season of recall. * indicates significant difference vs. the general population. Between-subject variability is not shown for the sake of clarity.

Supplementary Table S3 Contingency table showing the frequency distribution (across tertiles) of the proportion of energy from unprocessed/minimally processed foods (MPF), processed foods (PF) and ultra-processed foods (UPF) in the diet of the French adult population^a.

			Proportion of total energy intake from PF			Proportion of total energy intake from UPF		
			Tertile 1 (n=591)	Tertile 2 (n=592)	Tertile 3 (n=591)	Tertile 1 (n=591)	Tertile 2 (n=592)	Tertile 3 (n=591)
Proportion of total energy intake from MPF	Tertile 1 (n=591)	n	136	186	269	87	150	354
		%	7.67	10.48	15.16	4.9	8.46	19.95
	Tertile 2 (n=592)	n	168	193	231	181	235	176
		%	9.47	10.88	13.02	10.2	13.25	9.92
	Tertile 3 (n=591)	n	287	213	91	323	207	61
		%	16.18	12.01	5.13	18.21	11.67	3.44
Proportion of total energy intake from UPF	Tertile 1 (n=591)	n	103	169	319			
		%	5.81	9.53	17.98			
	Tertile 2 (n=592)	n	173	222	197			
		%	9.75	12.51	11.1			
	Tertile 3 (n=591)	n	315	201	75			
		%	17.76	11.33	4.23			

^aData from the Individual and National Study on Food Consumption Survey 3, *n*=1774. MPF, unprocessed/minimally processed foods; PF, processed foods; UPF, ultra-processed foods.

Supplementary Table S4 Sociodemographic characteristics according to tertiles of the proportion of unprocessed/minimally processed foods (MPF), processed foods (PF) and ultra-processed foods (UPF) in the diet of the French adult population^a.

	All population (n=1774)	Proportion of total energy intake from MPF				Proportion of total energy intake from PF				Proportion of total energy intake from UPF			
		T1 (n=591) 1.01- 27.66%	T2 (n=592) 27.67- 37.68%	T3 (n=591) 37.69- 76.91%	P	T1 (n=591) 0.00- 19.58%	T2 (n=592) 19.59- 30.21%	T3 (n=591) 30.22- 69.47%	P	T1 (n=591) 0.12- 20.62%	T2 (n=592) 20.68- 34.06%	T3 (n=591) 34.13- 78.92%	P
Sex, % males	49.9	56.6	48.9	43.0	<0.001	40.1	48.0	62.2	<0.001	48.5	49.5	51.4	0.603
Age group, %					<0.001				<0.001				<0.001
18-24 y	10.3	13.7	7.8	8.9		19.2	5.4	5.8		4.6	3.6	20.5	
25-34 y	15.9	23.4	12.5	10.5		20.9	15.1	11.5		4.1	15.2	25.7	
35-49 y	30.7	33.5	30.5	27.5		28.1	38.6	25.6		23.7	33.6	33.7	
50-65 y	25.8	20.3	30.1	27.9		21.0	23.1	33.6		34.4	32.0	13.8	
65-79 y	17.4	9.1	19.1	25.3		10.9	17.9	23.6		33.4	15.6	6.3	
Educational level, %					0.417				0.014				<0.001
Primary school	47.0	44.7	47.0	49.7		44.0	44.9	52.1		53.2	47.2	42.0	
Middle school	17.7	17.0	18.3	17.8		21.5	16.9	14.4		15.8	13.2	23.0	
Secondary school	17.4	19.3	17.8	14.7		16.8	18.1	17.3		14.7	18.8	18.3	
College or university	18.0	18.9	17.0	17.9		17.7	20.0	16.2		16.4	20.9	16.7	
Occupational status, %					<0.001				<0.001				<0.001
Employee	15.6	16.9	15.7	13.9		22.9	10.5	13.1		10.0	16.5	19.3	
Manual worker	13.1	14.8	14.1	9.8		13.6	15.1	10.5		7.0	13.1	17.8	
Farmer	0.7	0.6	0.6	0.9		0.1	1.0	0.9		1.0	0.9	0.2	
Craftsman, shopkeeper, business owner	3.3	3.1	3.4	3.5		2.4	2.5	5.2		4.4	4.3	1.7	
Intermediate profession	19.6	22.7	19.3	16.2		16.9	25.3	16.8		12.9	19.8	24.7	
Professional, executive	13.2	14.9	13.5	10.8		10.8	14.2	14.7		12.8	14.8	12.1	
Retired	23.1	13.8	25.7	31.6		14.9	22.5	32.4		44.3	20.5	8.8	
Inactive	11.4	13.1	7.7	13.3		18.5	9.1	6.4		7.6	10.2	15.5	
Region of France, %					0.001				0.005				0.238
Ile-de-France (Paris area)	17.4	16.0	16.3	20.4		18.4	15.7	18.1		17.9	19.1	15.6	
North-West	19.8	22.3	22.3	14.3		17.3	21.9	20.4		17.8	19.9	21.4	
North-East	27.2	26.8	29.9	24.7		28.5	30.5	22.5		24.8	28.5	27.9	
South-East	17.9	19.0	15.2	19.4		19.2	13.6	20.8		19.8	17.2	17.0	
South-West	17.7	16.0	16.3	21.3		16.6	18.3	18.3		19.7	15.3	18.2	
City size, %					<0.001				<0.001				<0.001
Rural	26.1	20.3	31.1	27.7		22.4	25.8	30.3		31.4	28.4	20.0	
2 000-19 999 hab.	17.6	19.8	18.5	14.0		15.5	16.0	21.4		19.0	17.8	16.3	
20 000-99 999 hab.	11.0	9.7	14.0	9.2		12.4	9.5	10.9		11.1	9.3	12.2	
≥100 000 hab.	32.4	37.1	27.0	32.6		33.5	36.9	26.8		25.9	31.7	38.1	
Paris agglomeration	13.0	13.1	9.5	16.5		16.3	11.8	10.7		12.6	12.8	13.4	

^a Data from the Individual and National Study on Food Consumption Survey 3, n=1774. Values are percentages weighted for the survey design.

* P values are from χ^2 test. NS. "Refusals to answer" were included in the statistical test (for Matrimonial status and Perception of financial status)
MPF, unprocessed/minimally processed foods; NS, nonsignificant; PF, processed foods; T, tertile; UPF, ultra-processed foods; y, years old

Supplementary Table S4 (continued)

	All population (n=1774)	Proportion of total energy intake from MPF				Proportion of total energy intake from PF				Proportion of total energy intake from UPF			
		T1 (n=591)	T2 (n=592)	T3 (n=591)	P	T1 (n=591)	T2 (n=592)	T3 (n=591)	P	T1 (n=591)	T2 (n=592)	T3 (n=591)	P
		1.01- 27.66%	27.67- 37.68%	37.69- 76.91%		0.00- 19.58%	19.59- 30.21%	30.22- 69.47%		0.12- 20.62%	20.68- 34.06%	34.13- 78.92%	
Season of record, %					<0.001				<0.001				0.417
<i>Winter</i>	24.5	20.8	21.9	31.8		32.5	22.0	18.7		25.2	24.3	24.1	
<i>Spring</i>	25.0	28.4	23.5	22.7		21.7	26.0	27.7		25.6	25.7	24.0	
<i>Summer</i>	25.6	30.4	25.5	19.9		22.7	27.3	26.9		23.5	23.8	28.7	
<i>Autumn</i>	24.9	20.5	29.2	25.6		23.2	24.8	26.8		25.7	26.2	23.1	
Matrimonial status, %					<0.001				<0.001				<0.001
<i>Single</i>	20.3	22.4	19.3	19.0		29.3	14.7	16.6		12.8	15.3	30.6	
<i>Married</i>	48.9	42.4	49.4	56.2		38.5	52.2	56.6		63.5	56.3	31.2	
<i>Unmarried couple</i>	19.3	24.9	20.8	11.0		20.2	20.0	17.7		11.5	17.8	26.7	
<i>Widowed</i>	3.5	2.6	3.3	4.7		3.6	3.1	3.7		4.5	3.3	2.8	
<i>Separated/divorced</i>	8.0	7.7	7.3	8.9		8.4	10.2	5.3		7.7	7.3	8.8	
<i>Refusal to answer</i>	0.0	0.0	0.0	0.1		0.0	0.0	0.1		0.1	0.0	0.0	
Perception of financial status, %					0.002				0.183				0.027
<i>Financially comfortable</i>	14.7	14.5	15.2	14.4		14.5	15.0	14.7		15.0	16.0	13.4	
<i>It's okay</i>	36.2	33.0	38.5	37.7		35.2	34.4	39.1		39.8	37.2	32.6	
<i>It's tight</i>	10.8	9.3	10.3	13.2		10.7	12.0	9.8		12.0	9.7	10.8	
<i>Manageable if careful</i>	29.5	31.3	31.1	25.5		29.4	30.3	28.7		27.3	28.7	31.8	
<i>Hard to make ends meet</i>	7.9	10.5	4.4	8.4		8.5	7.9	7.3		5.2	7.9	10.0	
<i>Can't manage without debts</i>	0.9	1.4	0.5	0.8		1.9	0.3	0.4		0.6	0.5	1.4	
<i>Refusal to answer</i>	0.0	0.0	0.1	0.0		0.0	0.1	0.0		0.1	0.0	0.0	
Food insufficiency, %					0.005				0.106				<0.001
<i>Food sufficiency</i>	83.2	79.0	85.5	85.9		80.7	83.8	85.2		87.1	84.7	78.9	
<i>Qualitative food insufficiency</i>	14.2	18.2	11.6	12.0		17.1	13.5	11.7		11.6	10.8	19.0	
<i>Quantitative food insufficiency</i>	2.6	2.8	2.9	2.1		2.3	2.6	3.0		1.4	4.5	2.0	
Food insecurity, %					<0.001				0.032				<0.001
<i>Food security</i>	92.1	87.1	96.7	93.2		90.3	91.5	94.5		95.3	94.1	87.9	
<i>Moderate food insecurity</i>	4.9	8.4	1.6	4.0		5.4	6.0	3.1		2.5	3.8	7.6	
<i>Severe food insecurity</i>	3.1	4.4	1.7	2.8		4.3	2.5	2.4		2.2	2.1	4.6	
Body Mass Index (BMI), %					0.005				0.005				0.013
<i>Underweight (BMI<18.5)</i>	3.5	4.0	4.7	1.7		5.1	3.3	2.2		2.4	3.4	4.5	
<i>Normal weight (18.5≤BMI<25)</i>	48.6	50.4	50.9	44.0		52.8	44.7	48.0		44.3	49.1	51.6	
<i>Overweight (25≤BMI<30)</i>	34.8	33.9	32.2	38.6		31.5	37.1	36.0		36.9	34.4	33.4	
<i>Obesity (BMI≥30)</i>	13.1	11.7	12.3	15.7		10.6	15.0	13.8		16.5	13.1	10.5	
BMI, kg/m ² (mean ± SD)	25.3 ± 4.4	25.1 ± 4.5	25.1 ± 4.4	25.8 ± 4.4		24.6 ± 4.7	25.8 ± 4.4	25.5 ± 4.1		25.8 ± 4.7	25.3 ± 4.2	24.8 ± 4.8	

Supplementary Table S5 Total, plant and animal protein intakes and distribution of food families to animal or plant protein intake according to tertiles of the proportion of unprocessed/minimally processed foods (MPF), processed foods (PF) and ultra-processed foods (UPF) in the diet of the French adult population^a.

	All population (n=1774)		Proportion of total energy intake from MPF						Proportion of total energy intake from PF						Proportion of total energy intake from UPF					
			T1 (n=591)		T2 (n=592)		T3 (n=591)		T1 (n=591)		T2 (n=592)		T3 (n=591)		T1 (n=591)		T2 (n=592)		T3 (n=591)	
			1.01-27.66%		27.67-37.68%		37.69-76.91%		0.00-19.58%		19.59-30.21%		30.22-69.47%		0.12-20.62%		20.68-34.06%		34.13-78.92%	
	Mean	SEM	Mean ^b	SEM	Mean	SEM	Mean	SEM	Mean	SEM	Mean	SEM	Mean	SEM	Mean	SEM	Mean	SEM	Mean	SEM
Total protein, g/d	81.7	0.4	76.8	0.7	81.8**	0.7	87.4**	0.7	78.7	0.7	82.2**	0.7	84.2**	0.7	83.3	0.8	82.7	0.7	79.4**	0.7
Animal protein, g/d	55.7	0.5	51.1	0.7	55.8**	0.8	61.0**	0.8	55.0	0.8	57.0	0.8	55.2	0.8	54.9	0.8	56.9	0.8	55.3	0.7
BI-APF	0.73	0.00	0.73	0.00	0.73	0.00	0.71**	0.00	0.72	0.00	0.73	0.00	0.72	0.00	0.71	0.00	0.73*	0.00	0.73**	0.00
Protein from animal-based families, % of animal protein																				
<i>Red meat</i>	24.2	0.5	21.3	0.7	25.3**	0.8	26.5**	0.8	24.8	0.8	24.3	0.8	23.4	0.8	24.2	0.8	25.1	0.8	23.3	0.7
<i>Poultry</i>	13.1	0.4	10.8	0.6	12.4	0.7	16.6**	0.7	14.3	0.6	12.3*	0.7	12.7	0.7	14.6	0.7	13.1	0.7	11.9*	0.6
<i>Processed meat</i>	12.2	0.3	16.9	0.4	11.5**	0.5	7.4**	0.5	10.9	0.5	12.6*	0.5	13.2**	0.5	9.8	0.5	10.9	0.5	15.2**	0.4
<i>Fish</i>	10.9	0.3	7.8	0.5	12.2**	0.6	13.3**	0.6	10.7	0.6	10.8	0.6	11.3	0.6	12.2	0.6	12.3	0.6	8.7**	0.5
<i>Eggs</i>	6.1	0.2	6.3	0.2	6.0	0.3	6.0	0.3	7.1	0.3	6.0*	0.3	5.1**	0.3	6.2	0.3	6.0	0.3	6.1	0.2
<i>Milk</i>	8.8	0.2	9.6	0.4	7.9*	0.4	8.6	0.4	11.2	0.4	8.8**	0.4	6.2**	0.4	6.6	0.4	7.7*	0.4	11.3**	0.4
<i>Cheese</i>	16.3	0.3	19.9	0.5	16.4**	0.5	11.8**	0.5	12.0	0.5	16.6**	0.5	20.4**	0.5	17.4	0.5	15.6*	0.5	15.8*	0.5
<i>Yogurt</i>	6.0	0.2	5.3	0.3	5.8	0.3	7.2**	0.3	7.0	0.3	6.1*	0.3	5.0**	0.3	6.1	0.3	6.7	0.3	5.4	0.3
<i>Offal</i>	1.1	0.1	1.0	0.2	1.2	0.2	1.2	0.2	0.7	0.2	1.3*	0.2	1.4*	0.2	1.4	0.2	1.1	0.2	0.9*	0.2
<i>Game</i>	0.2	0.1	0.1	0.1	0.2	0.1	0.5**	0.1	0.1	0.1	0.1	0.1	0.5*	0.1	0.6	0.1	0.2**	0.1	0.0**	0.1
<i>Other dairy products</i>	1.1	0.0	1.1	0.1	1.2	0.1	0.9*	0.1	1.2	0.1	1.1	0.1	0.9*	0.1	0.9	0.1	1.1*	0.1	1.1*	0.1
Plant protein, g/d	26.0	0.1	25.7	0.2	25.9	0.2	26.4*	0.3	23.7	0.2	25.3**	0.2	29.0**	0.2	28.4	0.2	25.8**	0.2	24.1**	0.2
Plant protein, % of total protein	33.2	0.2	35.0	0.4	33.0**	0.4	31.2**	0.4	31.7	0.4	32.2	0.4	35.7**	0.4	35.3	0.4	32.4**	0.4	32.2**	0.4
BI-PBF	0.59	0.00	0.55	0.01	0.60**	0.01	0.64**	0.01	0.64	0.01	0.61**	0.01	0.53**	0.01	0.58	0.01	0.61*	0.01	0.59	0.01
Protein from plant-based families, % of plant protein																				
<i>Refined grains</i>	55.0	0.4	60.7	0.7	55.7**	0.7	47.3**	0.7	48.8	0.7	54.1**	0.7	62.2**	0.7	54.8	0.8	53.6	0.8	56.1	0.7
<i>Whole grains</i>	5.3	0.2	4.1	0.4	5.6*	0.4	6.4**	0.4	5.7	0.4	5.9	0.4	4.3*	0.4	5.7	0.4	5.9	0.4	4.5*	0.4
<i>Nuts and seeds</i>	3.1	0.1	2.5	0.2	3.2*	0.2	3.8**	0.3	3.5	0.2	3.2	0.2	2.6*	0.2	3.1	0.3	3.4	0.2	2.9	0.2
<i>Legumes</i>	2.8	0.2	2.4	0.3	2.9	0.3	3.1	0.3	3.3	0.3	2.7	0.3	2.3*	0.3	2.5	0.3	3.0	0.3	2.9	0.3
<i>Vegetables</i>	12.6	0.2	9.4	0.3	12.4**	0.3	16.6**	0.3	13.6	0.3	12.6*	0.4	11.4**	0.4	14.9	0.4	12.6**	0.3	10.8**	0.3
<i>Potatoes</i>	7.1	0.2	6.1	0.3	6.7	0.3	8.7**	0.3	7.8	0.3	7.4	0.3	6.0**	0.3	7.5	0.3	7.4	0.3	6.5*	0.3
<i>Fruits</i>	5.9	0.1	4.6	0.2	5.8**	0.2	7.4**	0.2	6.9	0.2	5.7**	0.2	5.0**	0.2	6.3	0.2	6.1	0.2	5.3**	0.2
<i>Other plant foods</i>	8.3	0.2	10.3	0.3	7.7**	0.3	6.7**	0.3	10.3	0.3	8.3**	0.3	6.2**	0.3	5.1	0.3	8.0**	0.3	11.1**	0.2

^a Data from the Individual and National Study on Food Consumption Survey 3, n=1774. Data were collected by three 24h recalls.

^b Means adjusted for season of recall and weighted for the survey design. Significantly different from the mean of the first tertile: *, P<0.05; **, P<0.001; P ≥ 0.05, NS. P for ANOVA tests adjusted for season of recall.

BI-ABF: Berry-Index Animal-based families; BI-PBF: Berry-Index Plant-based families; MPF, unprocessed/minimally processed foods; NS, nonsignificant; PF, processed foods; SEM: standard error of the mean; T, tertile; UPF, ultra-processed foods.

Supplementary Table S6 PANDiet score and subscores and plant-based diet indices according to tertiles of the proportion of unprocessed/minimally processed foods (MPF), processed foods (PF) and ultra-processed foods (UPF) in the diet of the French adult population^a.

	All population (n=1774)		Proportion of total energy intake from MPF						Proportion of total energy intake from PF						Proportion of total energy intake from UPF					
			T1 (n=591) 1.01-27.66%		T2 (n=592) 27.67-37.68%		T3 (n=591) 37.69-76.91%		T1 (n=591) 0.00-19.58%		T2 (n=592) 19.59-30.21%		T3 (n=591) 30.22-69.47%		T1 (n=591) 0.12-20.62%		T2 (n=592) 20.68-34.06%		T3 (n=591) 34.13-78.92%	
	Mean	SEM	Mean ^b	SEM	Mean	SEM	Mean	SEM	Mean ²	SEM	Mean	SEM	Mean	SEM	Mean ²	SEM	Mean	SEM	Mean	SEM
PANDiet score (0-100)	64.3	0.14	62.6	0.22	64.5**	0.24	66.2**	0.24	63.5	0.24	64.2*	0.24	65.3**	0.24	65.3	0.25	65.0	0.24	62.9**	0.22
AS (0-100)	63.6	0.31	62.2	0.51	64.7*	0.54	64.2*	0.56	61.6	0.53	64.0*	0.54	65.4**	0.54	64.7	0.57	64.1	0.54	62.3*	0.50
Probabilities of adequacy for AS components (0-1)																				
<i>Protein</i>	0.89	0.00	0.89	0.01	0.91	0.01	0.87	0.01	0.86	0.01	0.89*	0.01	0.92**	0.01	0.87	0.01	0.90*	0.01	0.90*	0.01
<i>LA</i>	0.43	0.01	0.46	0.01	0.41*	0.01	0.42*	0.01	0.49	0.01	0.46	0.01	0.34**	0.01	0.34	0.01	0.45**	0.01	0.48**	0.01
<i>ALA</i>	0.11	0.00	0.11	0.01	0.11	0.01	0.11	0.01	0.13	0.01	0.10*	0.01	0.09*	0.01	0.10	0.01	0.12	0.01	0.10	0.01
<i>DHA</i>	0.22	0.01	0.15	0.01	0.25**	0.01	0.28**	0.01	0.22	0.01	0.23	0.01	0.23	0.01	0.25	0.01	0.23	0.01	0.19*	0.01
<i>EPA+DHA</i>	0.20	0.01	0.14	0.01	0.22**	0.01	0.25**	0.01	0.19	0.01	0.20	0.01	0.20	0.01	0.22	0.01	0.21	0.01	0.17*	0.01
<i>Fiber</i>	0.39	0.01	0.37	0.01	0.40	0.01	0.41	0.01	0.35	0.01	0.38*	0.01	0.45**	0.01	0.46	0.01	0.38**	0.01	0.34**	0.01
<i>Vitamin A</i>	0.52	0.01	0.49	0.01	0.56*	0.01	0.51	0.01	0.46	0.01	0.53**	0.01	0.56**	0.01	0.60	0.01	0.51**	0.01	0.47**	0.01
<i>Thiamin</i>	0.96	0.00	0.96	0.00	0.96	0.00	0.97**	0.00	0.96	0.00	0.97*	0.00	0.97*	0.00	0.96	0.00	0.97	0.00	0.96	0.00
<i>Riboflavin</i>	0.76	0.01	0.75	0.01	0.78	0.01	0.75	0.01	0.71	0.01	0.77**	0.01	0.80**	0.01	0.77	0.01	0.77	0.01	0.75	0.01
<i>Niacin</i>	1.00	0.00	1.00	0.00	1.00*	0.00	1.00*	0.00	0.99	0.00	1.00**	0.00	1.00**	0.00	1.00	0.00	1.00*	0.00	1.00	0.00
<i>Pantothenic acid</i>	0.87	0.00	0.85	0.01	0.89**	0.01	0.88*	0.01	0.84	0.01	0.88**	0.01	0.89**	0.01	0.87	0.01	0.88	0.01	0.86	0.01
<i>Vitamin B-6</i>	0.69	0.01	0.64	0.01	0.71**	0.01	0.74**	0.01	0.65	0.01	0.69*	0.01	0.73**	0.01	0.73	0.01	0.71	0.01	0.64**	0.01
<i>Folate</i>	0.66	0.01	0.61	0.01	0.70**	0.01	0.69**	0.01	0.63	0.01	0.66	0.01	0.70**	0.01	0.72	0.01	0.68*	0.01	0.61**	0.01
<i>Vitamin B-12</i>	0.65	0.01	0.62	0.01	0.66*	0.01	0.67*	0.01	0.61	0.01	0.65*	0.01	0.69**	0.01	0.66	0.01	0.66	0.01	0.63	0.01
<i>Vitamin C</i>	0.43	0.01	0.34	0.01	0.44**	0.02	0.52**	0.02	0.43	0.02	0.45	0.02	0.39	0.02	0.49	0.02	0.43*	0.02	0.37**	0.01
<i>Vitamin D</i>	0.03	0.00	0.03	0.00	0.04	0.00	0.04	0.00	0.03	0.00	0.03	0.00	0.03	0.00	0.04	0.00	0.03	0.00	0.03	0.00
<i>Vitamin E</i>	0.80	0.00	0.81	0.01	0.80	0.01	0.79	0.01	0.80	0.01	0.81	0.01	0.79	0.01	0.78	0.01	0.81*	0.01	0.81*	0.01
<i>Iodine</i>	0.72	0.01	0.71	0.01	0.72	0.01	0.74*	0.01	0.69	0.01	0.73*	0.01	0.75**	0.01	0.75	0.01	0.72	0.01	0.70*	0.01
<i>Magnesium</i>	0.48	0.01	0.48	0.01	0.50	0.01	0.48	0.01	0.47	0.01	0.45	0.01	0.53*	0.01	0.48	0.01	0.49	0.01	0.48	0.01
<i>Phosphorus</i>	0.97	0.00	0.96	0.00	0.98**	0.00	0.97**	0.00	0.96	0.00	0.98**	0.00	0.98**	0.00	0.97	0.00	0.98	0.00	0.96**	0.00
<i>Potassium</i>	0.66	0.01	0.64	0.01	0.68*	0.01	0.67*	0.01	0.61	0.01	0.66*	0.01	0.71**	0.01	0.70	0.01	0.67	0.01	0.62**	0.01
<i>Selenium</i>	0.95	0.00	0.93	0.00	0.95*	0.00	0.95*	0.00	0.94	0.00	0.95	0.00	0.95	0.00	0.94	0.00	0.95	0.00	0.94	0.00
<i>Absorbed zinc</i>	0.29	0.01	0.29	0.01	0.30	0.01	0.27	0.01	0.30	0.01	0.28	0.01	0.29	0.01	0.26	0.01	0.27	0.01	0.33**	0.01
<i>Copper</i>	0.91	0.00	0.91	0.01	0.92	0.01	0.89	0.01	0.88	0.01	0.91**	0.01	0.93**	0.01	0.91	0.01	0.91	0.01	0.90	0.01
<i>Manganese</i>	0.90	0.00	0.90	0.01	0.92	0.01	0.89*	0.01	0.87	0.01	0.91**	0.01	0.93**	0.01	0.91	0.01	0.91	0.01	0.89*	0.01
<i>Calcium</i>	0.64	0.01	0.67	0.01	0.64	0.01	0.60*	0.01	0.59	0.01	0.66**	0.01	0.66**	0.01	0.63	0.01	0.64	0.01	0.64	0.01
<i>Absorbed iron</i>	0.61	0.01	0.61	0.01	0.63	0.01	0.59	0.01	0.56	0.01	0.61**	0.01	0.68**	0.01	0.63	0.01	0.61	0.01	0.60*	0.01
MS (0-100)	65.0	0.23	63.0	0.37	64.3*	0.40	68.1**	0.41	65.4	0.39	64.5	0.40	65.2	0.40	66.0	0.42	65.9	0.40	63.5**	0.37
Probabilities of adequacy for MS components (0-1)																				
<i>Protein</i>	0.94	0.00	0.93	0.01	0.94	0.01	0.94	0.01	0.93	0.01	0.95	0.01	0.92	0.01	0.93	0.01	0.95	0.01	0.93	0.01
<i>Carbohydrates</i>	0.94	0.00	0.93	0.00	0.94	0.01	0.95*	0.01	0.94	0.00	0.97**	0.01	0.92**	0.01	0.92	0.01	0.95**	0.01	0.95**	0.00
<i>Total fat</i>	0.92	0.00	0.92	0.01	0.91	0.01	0.92	0.01	0.91	0.01	0.90	0.01	0.94**	0.01	0.93	0.01	0.91*	0.01	0.92	0.01
<i>SFA</i>	0.30	0.01	0.27	0.01	0.27	0.01	0.35**	0.01	0.32	0.01	0.24**	0.01	0.33	0.01	0.35	0.01	0.28**	0.01	0.26**	0.01
<i>Sugars (without lactose)</i>	0.65	0.01	0.61	0.01	0.65	0.01	0.71**	0.01	0.59	0.01	0.66**	0.01	0.71**	0.01	0.69	0.01	0.69	0.01	0.59**	0.01
<i>Sodium</i>	0.18	0.00	0.15	0.01	0.16	0.01	0.24**	0.01	0.26	0.01	0.16**	0.01	0.12**	0.01	0.17	0.01	0.19	0.01	0.19	0.01
PDI (18-90)	52.1	0.14	51.3	0.24	51.9	0.25	53.5**	0.26	52.1	0.25	51.9	0.25	52.4	0.25	53.5	0.26	52.1**	0.25	51.1**	0.23
hPDI (18-90)	52.4	0.16	51.4	0.26	52.4*	0.27	53.4**	0.28	51.2	0.27	52.3*	0.27	53.6**	0.27	54.4	0.28	53.0**	0.27	50.1**	0.25
uPDI (18-90)	55.6	0.18	58.4	0.29	55.1**	0.30	53.0**	0.32	56.3	0.31	55.3*	0.32	55.2*	0.32	53.7	0.32	54.1	0.31	58.4**	0.28

^a Data from the Individual and National Study on Food Consumption Survey 3, n=1774. Data were collected by three 24h-recalls.

^b Means adjusted for season of recall and weighted for the survey design. Significantly different from the mean of the first tertile: *, P<0.05; **, P<0.001; P ≥ 0.05, NS. P for ANOVA tests adjusted for season of recall.

ALA, alpha-linolenic acid; DHA, docosahexaenoic acid; EPA, eicosapentaenoic acid; hPDI, healthy Plant-based Diet Index; LA, linoleic acid; MPF, unprocessed/minimally processed foods; NS, non-significant; PANDiet, Probability of Adequate Nutrient Intake; PF, processed foods; SEM: standard error of the mean; SFA, saturated fatty acids; T, tertile; uPDI, unhealthy Plant-based diet Index, UPF, ultra-processed foods.

Supplementary Table S7 Predicted number of deaths avoided from cerebrovascular diseases, ischemic heart diseases and diabetes by each nutritional factor weighted in the comparative risk assessment using the EPIDiet model, in the context of a shift of the population's diet from the first tertile to the third tertile of the proportion of unprocessed/minimally processed foods (MPF), processed foods (PF) and ultra-processed foods (UPF) in the diet in the French adult population^a.

	Proportion of total energy intake from MPF – T3 vs T1			Proportion of total energy intake from PF – T3 vs T1			Proportion of total energy intake from UPF – T3 vs T1		
	Cerebrovascular diseases	Ischemic heart diseases	Diabetes	Cerebrovascular diseases	Ischemic heart diseases	Diabetes	Cerebrovascular diseases	Ischemic heart diseases	Diabetes
Death avoided or added by nutritional factors ^b (number)									
<i>Whole grains</i>	204	125	109	-177	-119	-104	-44	-16	-19
<i>PUFA</i>	38	474	NA	-3	-642	NA	-30	18	NA
<i>Nuts & Seeds</i>	NA	642	249	NA	-662	-245	NA	-19	-30
<i>SFA</i>	-36	-39	NA	-3	101	NA	31	-75	NA
<i>MUFA</i>	-18	-213	NA	-7	25	NA	25	133	NA
<i>Dietary cholesterol</i>	-3	-29	NA	2	-44	NA	8	64	NA
<i>Seafood omega-3 fats</i>	NA	800	NA	NA	-16	NA	NA	-703	NA
<i>Vegetables</i>	1017	419	NA	-226	-89	NA	-1049	-405	NA
<i>Fibers</i>	318	515	NA	-116	-118	NA	-192	-383	NA
<i>Processed meats</i>	NA	1157	364	NA	-14	-13	NA	-2164	-852
<i>Total fat</i>	-37	-113	NA	-6	142	NA	40	-87	NA
<i>Fruits</i>	814	504	NA	-421	-231	NA	-361	-182	NA
<i>Sodium</i>	245	260	NA	-389	-396	NA	179	177	NA
<i>Alcohol</i>	-27	-375	-93	-172	255	91	-285	94	-16
<i>Red meats unprocessed</i>	NA	NA	-124	NA	NA	7	NA	NA	51
<i>SSB</i>	-31	212	NA	-43	201	-22	-34	-527	-153
Death avoided or added because of energy intake and BMI ^b (number)									
<i>Total energy</i>	213	401	223	-193	-348	-209	63	90	57
<i>BMI</i>	180	375	167	-235	-391	-286	29	36	13
Total death avoided ^b (number)	2419 (2216, 2621)	4023 (3744, 4303)	665 (572, 759)	-1911 (-2109, -1713)	-1419 (-2097, -741)	-560 (-931, -188)	-1880 (-2165, -1595)	-5447 (-9439, -1457)	-1066 (-2248, 117)
Percentage deaths avoided ^b (%)	24.9 (22.8, 27.0)	30.9 (28.8, 33.0)	18.5 (15.9, 21.1)	-19.7 (-21.7, -17.6)	-10.9 (-16.1, -5.7)	-15.6 (-25.9, -5.2)	-19.4 (-22.3, -16.4)	-41.8 (-72.5, -11.2)	-29.6 (-62.5, 3.2)

^a Dietary data from the Individual and National Study on Food Consumption Survey in France (INCA3). Data were collected by three 24h-recalls.

^b Based on the numbers of disease-specific deaths observed in France in 2014. Negative values correspond to increasing deaths and positive values to decreasing deaths.

MPF, unprocessed/minimally processed foods; MUFA; Monounsaturated fatty acids; NA: Not applicable within the scope of this study; PF, processed foods; PUFA: Polyunsaturated fatty acids; SFA, Saturated fatty acids; SSB, sugar-sweetened beverage; T1: 1st tertile; T3: 3rd tertile; UPF, ultra-processed foods.

References

1. Food and Agriculture Organization of the United Nations (2013) Dietary protein quality evaluation in human nutrition: report of an FAO expert consultation, 31 March-2 April, 2011, Auckland, New Zealand. Food and Agriculture Organization of the United Nations, Rome
2. Anses (2016) Actualisation des repères du PNNS : élaboration des références nutritionnelles. French Agency for Food, Environmental and Occupational Health Safety (Anses)., Maisons-Alfort, France
3. Anses (2011) Actualisation des apports nutritionnels conseillés pour les acides gras. French Agency for Food, Environmental and Occupational Health Safety (Anses)., Maisons-Alfort, France
4. EFSA (European Food Safety Agency) (2017) Dietary Reference Values for nutrients: Summary report. 92. <https://doi.org/10.2903/sp.efsa.2017.e15121>
5. EFSA NDA Panel (EFSA Panel on Nutrition, Novel Foods and Food Allergens) (2016) Scientific opinion on Dietary Reference Values for vitamin B6. EFSA Journal
6. de Gavelle E, Huneau J-F, Mariotti F (2018) Patterns of Protein Food Intake Are Associated with Nutrient Adequacy in the General French Adult Population. *Nutrients* 10:226. <https://doi.org/10.3390/nu10020226>
7. Verger EO, Mariotti F, Holmes BA, et al (2012) Evaluation of a Diet Quality Index Based on the Probability of Adequate Nutrient Intake (PANDiet) Using National French and US Dietary Surveys. *PLoS ONE* 7:e42155. <https://doi.org/10.1371/journal.pone.0042155>
8. de Gavelle E, Huneau J-F, Fouillet H, Mariotti F (2019) The Initial Dietary Pattern Should Be Considered when Changing Protein Food Portion Sizes to Increase Nutrient Adequacy in French Adults. *The Journal of Nutrition* 149:488–496. <https://doi.org/10.1093/jn/nxy275>
9. Anses (2019) Anses Opinion on the updating of the PNNS dietary guidelines for women from menopause and men over 65 years of age. French Agency for Food, Environmental and Occupational Health Safety (Anses)., Maisons-Alfort, France
10. Satija A, Bhupathiraju SN, Rimm EB, et al (2016) Plant-Based Dietary Patterns and Incidence of Type 2 Diabetes in US Men and Women: Results from Three Prospective Cohort Studies. *PLoS Med* 13:e1002039. <https://doi.org/10.1371/journal.pmed.1002039>
11. Satija A, Bhupathiraju SN, Spiegelman D, et al (2017) Healthful and Unhealthful Plant-Based Diets and the Risk of Coronary Heart Disease in U.S. Adults. *Journal of the American College of Cardiology* 70:411–422. <https://doi.org/10.1016/j.jacc.2017.05.047>