



**HAL**  
open science

**Contrary to ultra-processed foods, the consumption of unprocessed or minimally processed foods is associated with favorable patterns of protein intake, diet quality and lower cardiometabolic risk in French adults (INCA3)**

Marion Salomé, Laura Arrazat, Juhui Wang, Ariane Dufour, Carine Dubuisson, Jean-Luc J.L. Volatier, Jean-François Huneau, François Mariotti

► **To cite this version:**

Marion Salomé, Laura Arrazat, Juhui Wang, Ariane Dufour, Carine Dubuisson, et al.. Contrary to ultra-processed foods, the consumption of unprocessed or minimally processed foods is associated with favorable patterns of protein intake, diet quality and lower cardiometabolic risk in French adults (INCA3). *European Journal of Nutrition*, 2021, 10.1007/s00394-021-02576-2 . hal-03280956

**HAL Id: hal-03280956**

**<https://hal.science/hal-03280956v1>**

Submitted on 7 Jul 2021

**HAL** is a multi-disciplinary open access archive for the deposit and dissemination of scientific research documents, whether they are published or not. The documents may come from teaching and research institutions in France or abroad, or from public or private research centers.

L'archive ouverte pluridisciplinaire **HAL**, est destinée au dépôt et à la diffusion de documents scientifiques de niveau recherche, publiés ou non, émanant des établissements d'enseignement et de recherche français ou étrangers, des laboratoires publics ou privés.

**This is the “postprint” version, i.e. the authors’ version that has been accepted for publication, of the article by Salomé et al., finally published in European Journal of Nutrition, published online: 8 May 2021.**

Full reference is:

Salomé, M., Arrazat, L., Wang, J. et al. Contrary to ultra-processed foods, the consumption of unprocessed or minimally processed foods is associated with favorable patterns of protein intake, diet quality and lower cardiometabolic risk in French adults (INCA3). *Eur J Nutr* (2021).

**The edited final article can be found on the publisher website,  
at: <https://doi.org/10.1007/s00394-021-02576-2>**

**Contrary to ultra-processed foods, the consumption of unprocessed or minimally processed foods is associated with favorable patterns of protein intake, diet quality and lower cardiometabolic risk in French adults (INCA3).**

**Marion Salomé<sup>1§</sup>, Laura Arrazat<sup>1§</sup>, Juhui Wang<sup>1</sup>, Ariane Dufour<sup>2</sup>, Carine Dubuisson<sup>2</sup>, Jean-Luc Volatier<sup>2</sup>, Jean-François Huneau<sup>1</sup>, François Mariotti<sup>1\*</sup>**

<sup>1</sup>Université Paris-Saclay, AgroParisTech, INRAE, UMR PNCA, 75005, Paris, France

<sup>2</sup>Risk Assessment Department, Methodology and Survey Unit, French Agency for Food, Environmental and Occupational Health & Safety (ANSES), 14 rue Pierre et Marie Curie, 94701 Maisons-Alfort Cedex, France

§ These authors contributed equally to this work.

Short title: Ultra-processed foods, protein intake and diet quality

\* Corresponding author: François Mariotti, 16 rue Claude Bernard, 75005 Paris, France, francois.mariotti@agroparistech.fr

ORCID number:

Jean-François Huneau : [0000-0001-7336-2617](https://orcid.org/0000-0001-7336-2617) ; François Mariotti: [0000-0002-4516-3853](https://orcid.org/0000-0002-4516-3853)

### **Acknowledgments**

The authors would like to thank Benjamin Allès (Nutritional Epidemiology Research Team (EREN) at Université Paris 13, France) for his scientific support in constructing the NOVA database and Emmanuelle Kesse-Guyot (Nutritional Epidemiology Research Team (EREN) at Université Paris 13, France) for her scientific contribution to the constitution of the disease mortality database for the EpiDiet model.

**List of abbreviations**

ANSES, French Agency for Food, Environmental and Occupational Health and Safety; AS, Adequacy Subscore; BI, Berry-Index; BI-ABF, Berry-Index – Animal-based families; BI-PBF, Berry-Index – Plant-based families; CIQUAL, French Centre for Information on Food Quality; EpiDiet, Evaluate the Potential Impact of a Diet; hPDI, healthful Plant-based Diet Index; INCA3, Third Individual and National Study on Food Consumption Survey; MPF, unprocessed/minimally processed foods; MPFp, proportion of total energy intake from MPF; MS, Moderation Subscore; PANDiet, Probability of Adequate Nutrient Intake; PDI, Plant-based Diet Index; PF, processed foods; PFp, proportion of total energy intake from PF; uPDI, unhealthful Plant-based Diet Index; UI, uncertainty interval; UPF, ultra-processed foods; UPFp, proportion of total energy intake from UPF.

**Declarations****Funding**

M Salomé's PhD fellowship is currently being funded by a research contract with Terres Univia, the French Interbranch organization for plant oils and proteins. F Mariotti is the scientific leader of this contract.

**Conflicts of interest/Competing interests**

The authors declare that they have no competing interests.

**Ethics approval**

The INCA3 study was carried out in accordance with the Declaration of Helsinki guidelines and was approved by the 'Comité Consultatif sur le Traitement de l'Information en matière de Recherche dans le domaine de la Santé' (Advisory Committee on Information Processing in Health Research).

**Consent to participate**

For the data collection of the INCA3 survey, oral consent was obtained, witnessed and formally recorded from participants.

**Consent for publication**

Not applicable

**Availability of data and materials**

The datasets of the INCA3 survey are available at [data.gouv.fr](http://data.gouv.fr). Data sets generated during the current study are available from the corresponding author on reasonable request.

**Code availability**

Custom code are available from the corresponding author on reasonable request.

**Authors' contributions**

Marion Salomé, Laura Arrazat and François Mariotti designed research; Marion Salomé, Laura Arrazat and Juhui Wang conducted research; Ariane Dufour, Carine Dubuisson and Jean-Luc Volatier provided the databases essential for the research; Jean-François Huneau provided methodological support. Marion Salomé and Laura Arrazat analyzed data and performed statistical analysis; Marion Salomé, Laura Arrazat, Juhui Wang and François Mariotti interpreted the results; Marion Salomé, Laura Arrazat, Juhui Wang and François

Mariotti wrote paper; Marion Salomé and François Mariotti had primary responsibility for the final content and all authors read and approved the final manuscript.

## 1 **Abstract**

2 *Purpose.* While the consumption of ultra-processed foods is steadily increasing, there is a  
3 growing interest in more sustainable diets that would include more plant protein. We aimed to  
4 study associations between the degree of food processing, patterns of protein intake, diet  
5 quality and cardiometabolic risk.

6 *Methods.* Using the NOVA classification, we assessed the proportion of energy from  
7 unprocessed/minimally processed foods (MPFp), processed foods (PFp) and ultra-processed  
8 foods (UPFp) in the diets of 1774 adults (18-79y) from the latest cross-sectional French  
9 national survey (INCA3, 2014-2015). We studied the associations between MPFp, PFp and  
10 UPFp with protein intakes, diet quality (using the PANDiet scoring system, the global (PDI),  
11 healthful (hPDI) and unhealthful (uPDI) plant-based diet indices) and the risk of  
12 cardiometabolic death (using the EpiDiet model).

13 *Results.* MPFp was positively associated with animal protein intake and plant-protein  
14 diversity, whereas PFp was positively associated with plant protein intake and negatively with  
15 plant-protein diversity. The PANDiet was positively associated with MPFp ( $\beta=0.14$ ,  
16  $P<0.0001$ ) but negatively with UPFp ( $\beta=-0.05$ ,  $P<0.0001$ ). These associations were modified  
17 by adjustment for protein intakes and plant-protein diversity. As estimated with comparative  
18 risk assessment modeling between extreme tertiles of intake, mortality from cardiometabolic  
19 diseases would be decreased with higher MPFp (e.g. by 31% for ischemic heart diseases)  
20 and increased with UPFp (by 42%) and PFp (by 11%).

21 *Conclusions.* In the French population, in contrast with UPFp, a higher MPFp was associated  
22 with a higher animal protein intake, a better plant-protein diversity, a higher diet quality and a  
23 markedly lower cardiometabolic risk.

24 *Keywords:* Ultra-processed Foods, Dietary Plant Protein, Dietary Animal Protein, Diet  
25 Quality, Plant-Based Diet.

## 26 **Introduction**

27 The development of industrially-produced foods is reshaping our food system and therefore  
28 influencing diets worldwide. At present, in many high-income countries such as the USA or  
29 UK, ultra-processed foods (UPF) (usually defined as convenient food and drink products with  
30 high industrial processing and generally many ingredients increasing shelf life and  
31 palatability [1, 2]), contribute more than half of dietary energy intake [3, 4]. In middle-income  
32 countries, this percentage is lower but is seeing a sharp rise [5]. The UPF available on the  
33 market are usually rich in energy, saturated fats, sugar and salt [4, 6]. They also have lower  
34 protein content than less processed foods and diets high in UPF have been associated with  
35 lower protein intake [4, 7].

36 In high-income countries, animal-based foods are the major source of protein but also have  
37 an important environmental footprint [8, 9]. Therefore, with regard to the global environmental  
38 impacts of the food system, a plant-based protein transition seems necessary to achieve  
39 more sustainable diets [10, 11].

40 However, although plant-based diets are known to have a positive impact on health [12–14],  
41 plant-based food products differ in terms of their quality and contribution to current diets. In  
42 particular, it has been shown that the associations between plant-based diets and incidences  
43 of coronary heart disease or type 2 diabetes are dependent on the types of plant foods  
44 consumed, whether they are considered as healthy plant foods (e.g. whole grains, fruits, etc.)  
45 or less-healthy plant foods such as more processed foods (e.g. sweetened beverages, fries,  
46 etc.) [15, 16]. Furthermore, it has been recently reported that some vegetarians diets are  
47 associated with high consumption of ultra-processed foods [17] suggesting that the benefit of  
48 diets high in plant-based foods may depend on the actual share of ultra-processed foods.

49 Indeed, an overall increase in the consumption of UPF has been thought to play a major role  
50 in the pandemics of obesity and diet-related chronic diseases [18, 19]. Many studies have  
51 recently reported associations between the consumption of UPF and non-communicable  
52 diseases [20–23] or mortality rates [24, 25]. An inpatient randomized controlled trial, where



53 ultra-processed and unprocessed diets were matched for presented energy and  
54 macronutrients, reported that the consumption of ultra-processed foods resulted in a higher  
55 energy intake (by ~500 kcal) and a 0.9 kg increase in body weight [26].

56 Therefore, the aim of this study was to investigate the consumption of foods with different  
57 processing degrees and the associated intake of animal or plant protein, the diet quality and  
58 predicted long-term health. We hypothesized that the degree of processing of foods in the  
59 diet is differentially associated with plant/animal protein sources, and that it could explain the  
60 resulting association with the diet quality and cardiometabolic health.

## 61 **Subjects and Methods**

### 62 ***Population and dietary data***

63 The population studied was derived from the third Individual and National Study on Food  
64 Consumption Survey (INCA3), performed in mainland France in 2014-2015 [27]. INCA3 is a  
65 nationwide and representative survey and its methodology and design are fully described  
66 elsewhere [28]. Of the 2121 adults (18-79y) who completed the whole protocol of the INCA3  
67 survey, under-reporting participants were excluded from their basal metabolic rate estimated  
68 using the Henry equation [29] and the cutoff points proposed by Black [30]. The final sample  
69 thus contained 1774 adults (749 males and 1025 females) (Supplementary Figure S1).

70 Food and beverage consumption was recorded using three nonconsecutive 24-h dietary  
71 recalls (two on weekdays, one at the week-end) over a 3-wk period. Dietary recalls were  
72 carried out by phone by professional investigators, assisted by the dietary software  
73 GloboDiet [31], and participants were not aware of the days of recall so they could not  
74 anticipate it. The nutrient contents of the foods and beverages were extracted from the 2016  
75 database generated by the French Center for Information on Food Quality (*Centre*  
76 *d'Information sur la Qualité des Aliments; CIQUAL*) [32]. Food items were classified into  
77 groups and sub-groups. Individual sociodemographic characteristics were collected from  
78 face-to-face and self-administered questionnaires [28].

### 79 ***Degree of food processing***

80 The NOVA classification [1] was applied to assess the degree of food processing for each  
81 food product in the INCA3 database. This classification encompasses four groups: 1)  
82 unprocessed/minimally processed foods (MPF), 2) processed culinary ingredients, 3)  
83 processed foods (PF) and 4) ultra-processed foods (UPF). To discriminate different foods  
84 between these categories, the classification takes account of the technical processing  
85 technique, the presence of additives and product composition. The present study focused on  
86 MPF, PF and UPF consumption.

87 For most of the food items consumed, the method of preparation was known. If the food was  
88 homemade, eaten in a restaurant or prepared by an artisan, it was broken down into its  
89 ingredients to which the NOVA classification was applied. If the food was industrially  
90 processed or came from a fast food restaurant, the NOVA classification was applied directly  
91 to the food item according to its degree of processing. If the method of preparation was  
92 unknown for a food item eaten by a participant, the most common method of preparation  
93 observed in the population for this particular food was assigned. For each participant the  
94 proportion (%) of total energy intake from unprocessed/minimally processed foods (MPFp),  
95 processed culinary ingredients, processed foods (PFp) and ultra-processed foods (UPFp)  
96 was calculated.

### 97 ***Identification of protein sources***

98 Using the decomposition of food items into ingredients, the protein origin of each ingredient  
99 was assigned to a food family. Food families were either plant-based (“Refined grains”,  
100 “Whole grains”, “Legumes”, “Nuts and seeds”, “Fruits”, “Vegetables”, “Potatoes” and “Other  
101 plant foods”) or animal-based (“Red meat”, “Poultry”, “Fish”, “Processed meat”, “Other  
102 meats”, “Eggs”, “Cheeses”, “Milk”, “Yogurt”, and “Other dairy products”).

103 The contribution of each plant-based family to plant protein intake was characterized using  
104 the Berry-Index – Plant-based families (BI-PBF) plant protein diversity index, as previously  
105 described [33]. The Berry-Index was used in previous studies to evaluate the evenness of

106 the distribution of total energy intake among food groups [34, 35]. The BI-PBF index is  
107 defined as  $1 - \sum_{i=0}^n s_i^2$ , where  $s_i$  is the share of plant-based family  $i$  in plant-protein intake,  
108 and  $n$  is the total number of plant-based families. A higher score reflects greater diversity  
109 with a more balanced contribution of each plant-based family to plant protein intake.  
110 Likewise, the Berry-Index – Animal-based families (BI-ABF) was used to assess the diversity  
111 of the contribution of animal-based families to animal protein intake.

### 112 ***Nutrient adequacy of the diet***

113 The nutrient adequacy of the diet was assessed using version 3.1. of the Probability of  
114 Adequate Nutrient Intake (PANDiet) scoring system [36, 37], based mainly on the dietary  
115 reference intake from the 2016 opinion issued by the French Agency for Food,  
116 Environmental, and Occupational Health and Safety (ANSES) [38]. The reference values  
117 were adapted to take account of the different nutrient requirements of adults aged over 65y  
118 [39]. The PANDiet score is the mean of the adequacy subscore (AS) and the moderation  
119 subscore (MS). AS is the mean of the probabilities of adequacy for 27 nutrients for which the  
120 usual intake should be above a reference value, multiplied by 100. MS is the mean of the  
121 probabilities of adequacy for six nutrients for which an upper bound reference value exists,  
122 multiplied by 100 (Supplementary Table S1). Each probabilities of adequacy are calculated  
123 using the mean intake, the intra-individual (i.e. day-to-day) variability of intake, the inter-  
124 individual variability and the nutrient reference value [36]. The PANDiet score ranges from 0  
125 to 100 and the higher the score, the better the overall nutrient adequacy of the diet.

### 126 ***Adherence to a plant-based diet***

127 The Plant-based Diet Indices, developed by Satija et al. [16], were used to assess how much  
128 a diet was based on plant-based foods. The PDIs comprise three indices which distinguish  
129 plant-based foods according to their impact on health: the overall plant-based diet index  
130 (PDI), the healthful plant-based diet index (hPDI) and the unhealthful plant-based diet index  
131 (uPDI). To calculate these scores, foods were assigned to healthy plant food groups (whole  
132 grains, fruits, vegetables, nuts, legumes, vegetable oils and tea/coffee), less healthy plant

133 food groups (fruit juices, sugar-sweetened beverages, refined grains, potatoes and  
134 sweets/desserts), or animal food groups (animal fats, dairy, eggs, fish/seafood, meat and  
135 miscellaneous animal-based foods). The consumption of each food group was calculated for  
136 each individual. The PDI gives more points to high consumers of plant-based food groups  
137 than to those with a high consumption of animal food groups. The hPDI gives more points to  
138 high consumers of healthy plant food groups and fewer points to high consumers of less  
139 healthy plant food groups and animal food groups. Symmetrically, the uPDI gives more  
140 points to high consumers of less healthy plant food groups than to high consumers of healthy  
141 plant food groups or animal food groups [15] (Supplementary Table S2).

#### 142 ***Predicting the impact on cardiometabolic death***

143 The impact of dietary patterns on cardiometabolic death was evaluated using the EpiDiet  
144 (Evaluate the Potential Impact of a Diet) model, which is a simulation-based nutritional and  
145 epidemiologic model that implements the Comparative Risk Assessment framework [11, 40],  
146 enabling prediction of the positive or negative impact on long-term health that would result  
147 from changes in the diet for an individual, group or population, as previously described [41].  
148 The EpiDiet model was written in Python and deployed on a High Performance Computing  
149 framework. Two sources of data were used to develop the EpiDiet model. The first source of  
150 data was the relative risk estimates that relates the nutritional factors to the disease endpoint  
151 and that have been reported in validated international meta-analyses [42–44]. Disease scope  
152 was defined according to the International Statistical Classification of Diseases and Related  
153 Health Problems [45]. Second, the French population demographics and mortality in 2014  
154 (being the year of the dietary survey) were used, provided respectively by the National  
155 Institute of Statistics and Economic Studies (INSEE) [46], and the Epidemiological Centre on  
156 Medical Causes of Death (CEPIDC) [47]. Nutritional factors and diseases included in the  
157 EpiDiet model are presented in Supplementary Figure S2. In this study, only coronary heart  
158 diseases, cerebrovascular diseases and diabetes were considered. The EpiDiet model  
159 therefore evaluated the potential impacts of dietary changes associated with patterns of

160 intake according to food processing on the number of death from these diseases in the  
161 French population, if the whole population was adopting the dietary change.

### 162 ***Statistical analysis***

163 The population was stratified into tertiles in three different ways according to the proportion of  
164 total energy intake from MPF (MPFp), PF (PFp) or UPF (UPFp) in their diet. Cross-classified  
165 frequencies of the MPFp, PFp and UPFp tertiles are presented in Supplementary Table S3.

166 Categorical variables are presented as percentages, and differences across the tertiles were  
167 assessed by  $\chi^2$  test. Continuous variables are presented as means  $\pm$  SEM, adjusted for the  
168 season of recall, in order to take into account that the degree of processing may depend on  
169 the seasonality of food products. Differences across the tertiles of each NOVA group or  
170 between the third tertiles of MPFp, PFp and UPFp within the general population were  
171 assessed by ANOVA adjusted for the season of recall. Protein intakes were adjusted for total  
172 energy intake using the residual method [48]. The weighting schemes proposed in INCA3  
173 were used to account for the complex survey design.

174 Associations between diet quality indices (PANDiet and PDIs) and the proportions of total  
175 energy intake from MPF, PF and UPF were analyzed using multiple linear regression  
176 models. First, the proportions of processed culinary ingredients, PF and UPF were included  
177 in the same model in order to study their associations with diet quality indices independently  
178 of each other. In this way, associations could be interpreted as the effect of substitution of  
179 one of these variables with the proportion of MPF (not included in the model and therefore  
180 taken as the reference). Associations with diet quality indices were then estimated separately  
181 for the proportions of total energy intake from MPF, PF and UPF, with a further adjustment  
182 for protein intakes and/or plant protein diversity. The potential confounding factors included in  
183 the models, because of their associations with NOVA groups, were total energy intake  
184 (continuous), age (continuous), sex (two levels), educational level (four levels), occupational  
185 status (eight levels), city size (five levels), perception of financial status (six levels), season of  
186 record (four levels), region of France (five levels) and matrimonial status (five levels).

187 For each NOVA group (MPF, PF and UPF), the EpiDiet model was implemented to compare  
188 the first tertile (baseline scenario) with the third tertile (counterfactual scenario). The number  
189 of deaths potentially avoided (or, conversely, added) were simulated among French adults  
190 from cerebrovascular, ischemic heart diseases and diabetes if the dietary patterns of the  
191 French population would shift from the baseline to the counterfactual scenario, according to  
192 the number of deaths observed in 2014 in the French population. The population was  
193 stratified 5-year age bands and sex in order to take better account of the disparities  
194 regarding diet, diseases and relative risks between groups. All foods and nutrients (except  
195 sodium) were adjusted for total energy intake using the residual method [49], while fatty  
196 acids were expressed as a percentage of total energy intake. Sensitivity analyses were  
197 performed to determine the weight of each nutritional factor in the estimation of number of  
198 deaths [50].

199 All statistical analyses were performed using SAS version 9.4 (SAS Institute Inc., Cary, NC,  
200 USA.), except the EpiDiet model that was performed with Python version 3.7.1. Significance  
201 was set at  $P < 0.05$ .

202

## 203 **Results**

204 In the overall population, MPF contributed to  $32.8 \pm 12.1\%$  of energy intake, PF to  $24.9 \pm$   
205  $12.2\%$  of energy intake and UPF to  $30.6 \pm 15.8\%$  of energy intake (data not shown).

206 Participants in the third tertile of MPFp, compared to those in the first tertile, were more likely  
207 to be women (57.0% vs 43.4%) and aged over 50y (53.2% vs 29.4%). Participants in the  
208 third tertile of PFp, compared to those in the first tertile, were more likely to be men (62.2%  
209 vs 40.1%) and aged over 50y (57.2% vs 31.9%). Participants in the third tertile of UPFp,  
210 versus those in the first tertile, were more likely to be younger than 35y (46.2% vs 8.7%) with  
211 no difference regarding sex (Supplementary Table S4).

## 212 ***Degree of processing and protein consumption***

213 Compared to the first tertile of MPFp, individuals in the third tertile consumed more animal  
214 protein (61.0 g/day vs 51.1 g/day) and plant protein (26.4 g/day vs 25.7 g/day) and had a  
215 lower contribution of plant protein in the diet (31.2% of total protein intake vs 35.0%). Red  
216 meat, poultry, fish and yogurt contributed more to animal protein intake whereas processed  
217 meat and cheese contributed less when compared to the first tertile (Supplementary Table  
218 S5). Regarding plant protein intake, refined grains had a lower contribution in the third tertile  
219 compared to the first (47.3% vs 60.7%) and other plant-based families made greater  
220 contributions which resulted in more plant protein diversity, expressed as BI-PBF (0.64 vs  
221 0.55), with a better contribution of different plant protein sources (Fig. 1a).

222

223 **Fig. 1** Contribution of plant-based food families to plant protein intake, expressed as the  
224 percentage of plant protein intake, and plant protein diversity, expressed as the Berry-Index  
225 – Plant-based families (BI-PBF) across tertiles of the proportion of total energy intake from a.  
226 unprocessed/minimally processed foods (MPF), b. processed foods (PF) and c. ultra-  
227 processed foods (UPF) in the French adult population INCA3 (n=1774) (Values are means  
228 adjusted for the season of recall; \* indicates significantly different from the first tertile)

229

230 Total animal protein intake did not change across the tertiles of PFp. However, cheese and  
231 processed meat contributed more to animal protein intake whereas milk, eggs and yoghurt  
232 contributed less in the third vs the first tertile. Plant protein intake was higher in the third  
233 compared to the first tertile of PFp (29.0 g/day vs 23.7 g/day) and so was the proportion of  
234 plant protein in the diet (35.7% of total protein intake vs 31.7%) (Supplementary Table S5).  
235 The contribution of refined grains to plant protein intake was higher in the third than in the  
236 first tertile (62.2% vs 48.8%) resulting in less plant protein diversity (BI-PBF of 0.53 vs 0.64).  
237 Therefore, plant protein intake was less evenly distributed among plant protein sources in the  
238 third than in the first tertile of PFp (Fig. 1b).

239 Plant protein intake was lower in the third tertile of UPFp than in the first tertile (24.1 g/day vs  
240 28.4 g/day and 32.3% of total protein intake vs 35.3%). Animal protein intake did not differ  
241 significantly across the UPFp tertiles, but when comparing the third tertile with the first,  
242 processed meat and milk contributed more to animal protein intake while poultry, fish and  
243 cheese contributed less (Supplementary Table S5). Plant protein diversity did not change  
244 significantly across the tertiles (Fig. 1c).

#### 245 ***Degree of processing and food group consumption***

246 As for protein intakes, mean intakes of food groups differed between the third tertiles of the  
247 proportion of MPF, PF and UPF in the diet (Supplementary Figure S3). Compared to the  
248 general population, participants in the highest tertile of MPFp consumed more plant foods  
249 that are usually minimally processed such as soups (+53%), nuts and oilseeds (+50%), and  
250 fruits (+36%), animal foods that are usually minimally processed such as fish (+37%), poultry  
251 (+32%) or milk (+31%) and less processed meat (-39%), savory pastries (-52%) and  
252 alcoholic beverages (-37%). Participants in the highest tertile of PFp consumed more refined  
253 bread (+67%), alcoholic beverages (+51%), cheeses (+40%) and processed meats (+15%)  
254 and less breakfast cereals (-63%) and sweet beverages (-48%) compared to the general  
255 population. Finally, participants in the highest tertile of UPFp consumed less minimally  
256 processed plant or animal foods, and more processed meats (+23%), sweet beverages  
257 (+70%), breakfast cereals (+63%), savory pastries (+59%), confectionery and chocolate  
258 (+39%) and fruit juices (+34%).

#### 259 ***Associations between food processing and diet quality, and related to protein intakes***

260 The PANDiet score and its sub-scores (adequacy sub-score, AS and moderation sub-score,  
261 MS) increased with the proportion of MPF and to a lesser extent with the proportion of PF,  
262 whereas they decreased in the higher tertile of UPFp. Similarly, the PDI and hPDI scores  
263 increased with the proportion of MPF and decreased with the proportion of UPF. The  
264 opposite trend was observed for the uPDI score (Fig. 2 and Supplementary Table S6).



265

266 **Fig. 2** Diet quality indices across tertiles of the proportion of total energy intake from  
267 respectively unprocessed/minimally processed foods (MPFp), processed foods (PFp) and  
268 ultra-processed foods (UPFp) in the French adult population INCA3 (n=1774). a, b and c  
269 respectively, PANDiet score, Adequacy sub-score (AS) and Moderation sub-score (MS). d, e  
270 and f respectively, Plant-based diet (PDI), Healthy plant-based diet (hPDI) and Unhealthy  
271 plant-based diet (uPDI) scores (values are means  $\pm$  SEM adjusted for the season of recall; \*  
272 indicates significantly different from the first tertile)

273

274 In a model using mutually adjusted NOVA categories and representing substitutions for  
275 MPFp, PANDiet was negatively associated with increases of PFp ( $\beta=-0.11$ ) and UPFp ( $\beta=-$   
276  $0.16$ ), while uPDI was positively associated with PFp ( $\beta=0.12$ ) and UPFp ( $\beta=0.13$ ) and hPDI  
277 was negatively associated with UPFp ( $\beta=-0.05$ ) but not with PFp (Table 1).

278 Associations with PANDiet, hPDI and uPDI were then evaluated independently with respect  
279 to MPFp, PFp and UPFp variables (Table 2). The PANDiet score was positively associated  
280 with MPFp ( $\beta=0.14$ ), and the association was attenuated when controlling for protein intake  
281 and/or plant protein diversity (BI-PBF). PANDiet was not associated with PFp but was  
282 associated when controlling for BI-PBF ( $\beta=0.05$ ) and negatively associated when controlling  
283 for protein intake ( $\beta=-0.08$ ) and when controlling for protein intake and BI-PBF ( $\beta=-0.04$ ).  
284 PANDiet was negatively associated with UPFp ( $\beta=-0.05$ ) in all models except when  
285 controlling only for protein intake. hPDI was positively associated with MPFp ( $\beta=0.04$ ) unless  
286 controlling for BI-PBF, but not associated with PFp (unless controlling for BI-PBF ( $\beta=0.11$ ) or  
287 for protein ( $\beta=-0.03$ )), and negatively associated with UPFp ( $\beta=-0.07$ ) in all models. uPDI was  
288 negatively associated with MPFp ( $\beta=-0.13$ ) in all models but the association was attenuated  
289 when controlling for protein intake and BI-PBF, and positively associated with PFp ( $\beta=0.04$ ),  
290 unless when controlling for BI-PBF ( $\beta=-0.07$ ), and UPFp ( $\beta=0.06$ ) in all models.

291 Furthermore, the association between the degree of food processing and its impact on health  
292 outcomes was estimated according to the dietary patterns computed from the proportion of  
293 total energy intake from MPF, PF and UPF taken separately, using the EpiDiet model. Our  
294 simulation revealed that diets containing a higher proportion of MPF could be more beneficial  
295 to health (Fig. 3). Compared to the figures of death observed in the French population in  
296 2014 (9,709 deaths from cerebrovascular diseases, 13,020 from ischemic heart diseases  
297 and 3,597 from diabetes), consumption of a diet with higher MPFp (consumption pattern of  
298 the 3<sup>rd</sup> tertile of MPFp compared to the 1<sup>st</sup> tertile) could potentially decrease the number of  
299 deaths from cerebrovascular diseases by 25% [23-27%, 95% uncertainty interval] with 2419  
300 deaths being avoided, from ischemic heart diseases by 31% [29-33%, 95%UI] with 4023  
301 deaths being avoided, and from diabetes by 19% [16-21%, 95%UI] with 665 deaths being  
302 avoided. Meanwhile, higher share of UPFp in the diet (consumption pattern of the 3<sup>rd</sup> tertile of  
303 UPFp compared to the 1<sup>st</sup> tertile) could increase deaths from metabolic diseases: the  
304 theoretical percentage of deaths added was 19% [16-22%, 95%UI] for cerebrovascular  
305 diseases (+1880 deaths), 42% [11-73%, 95%UI] for ischemic heart diseases (+5448 deaths)  
306 and 30% [-3-63%, 95%UI] for diabetes (+1066 deaths). The same numbers for dietary  
307 patterns computed from PFp were 20% [18-22%, 95%UI] for cerebrovascular diseases  
308 (+1911 deaths), 11% [6-16%, 95%UI] for ischemic heart diseases (+1419 deaths), and 16%  
309 [5-26%, 95%UI] for diabetes (+560 deaths). For the estimation of the avoided death with  
310 higher MPF consumption, main explaining factors of the model were the higher consumption  
311 of fruits and vegetables and the lower consumption of processed meats. For the estimation  
312 of the excess death with higher PF consumption, main explaining factors of the model were  
313 the lower consumption of nuts and seeds, the higher consumption of sodium and a higher  
314 energy intake, whereas for excess death with higher UPF consumption, main explaining  
315 factors of the model were the lower consumption of vegetables and the higher consumption  
316 of processed meats and sugar-sweetened beverages (Supplementary Table S7).

317

318 **Fig. 3** Estimation of potentially avoided or added cardiometabolic deaths ( $\pm$  95% CI) when  
319 shifting from first to third tertile of MPFp (proportion of total energy intake from  
320 unprocessed/minimally processed foods), PFp (proportion of total energy intake from  
321 processed foods) and UPFp (proportion of total energy intake from ultra-processed food, as  
322 predicted by the EpiDiet (Evaluate the Potential Impact of a Diet), compared to the number of  
323 deaths of the French adult population (the percentage corresponds to the percentage of  
324 death added (if positive) or avoided (if negative))

325

## 326 **Discussion**

327 This study has shown that consumption of MPF was associated with total and animal protein  
328 intakes and diet quality; consumption of PF was associated with under-diversified plant  
329 protein intake and inversely with diet quality; and consumption of UPF was inversely  
330 associated with total protein intake and diet quality. Most associations between the degree of  
331 food processing and diet quality were attenuated when adjusting for total protein intake and  
332 plant protein diversity.

333 The sociodemographic characteristics of people consuming high proportions of MPF and PF  
334 in their diet had many similarities and both appeared to contrast with those of individuals  
335 eating a high proportion of UPF. Similar sociodemographic profiles for high consumers of  
336 MPF had been found in a study in the UK, where women and older people had a higher  
337 percentage of energy intake from MPF [51]. The fact that younger adults and people in lower  
338 socioeconomic groups consume more UPF has been reported in previous studies [52–54].  
339 This can be taken as an illustration of the continuing shift from traditional diets towards a  
340 western diet that is rendered uniform by ultra-processed foods [55].

341 The degree of food processing was associated with the plant/animal protein pattern. A higher  
342 consumption of MPF meant higher intakes of total protein mostly as animal protein. This  
343 could be expected inasmuch as the main food groups contributing to animal-based proteins

344 are classified as unprocessed/minimally processed foods such as poultry, red meat, fish,  
345 yogurt and milk. With a higher PF consumption, intakes of plant protein were higher, and this  
346 could be almost fully ascribed to a much higher intake of bread, under a general pattern that  
347 may be referred to as traditional [56, 57]. Indeed, in high PF consumers, 62% of plant protein  
348 came from refined grains, which explains why a higher consumption of processed foods was  
349 associated with a poorer plant protein diversity, in contrast with high consumers of MPF who  
350 had a more diverse plant protein intake. High consumers of UPF had lower protein intakes,  
351 as reported in previous studies [51, 58, 59], this could be ascribed to a lower consumption of  
352 protein food groups and higher intake of more miscellaneous food groups low in protein such  
353 as sweet beverages, pastries or confectionery.

354 This study provides a fairly comprehensive view of the relationship between the degree of  
355 food processing and diet quality. Higher consumers of MPF had greater nutrient adequacy,  
356 higher healthful PDI, lower unhealthful PDI, and a lower predicted risk of death from  
357 cardiometabolic diseases, whereas the opposite applied among higher consumers of UPF.  
358 The results using substitution models clearly showed that substituting MPF by PF or UPF  
359 had a detrimental effect on diet quality.

360 In another French population, poorer compliance with dietary guidelines was found in the  
361 highest quartile of ultra-processed food consumers [52]. This association had also been  
362 found in the US population where overall dietary quality was measured using a nutrient  
363 balanced-pattern PCA-derived factor score [59]. The consumption of UPF has been  
364 associated with excessive sugar intake [60] and with lower intakes of vitamins and minerals  
365 [58], although this might depend on the level of usage of fortification in the food industry.  
366 Regarding long-term health effects of consumption of UPF, our assessment of changes in  
367 mortality rates from cardiovascular diseases are in line with findings in the literature,  
368 inasmuch as a higher consumption of ultra-processed foods has been associated with a  
369 higher risk of all-cause mortality of 31% in the USA [25] and 44% in Spain [24]. Among UK  
370 adults, a higher consumption of UPF has also been associated with a higher risk of obesity

371 [61]. While the literature regarding UPF consumption has been growing, characterizing diet  
372 quality and the health impact of consuming MPF have been overlooked and the data are  
373 scarce [51]. However, it should be noted that a high consumption of MPF is ubiquitous in  
374 traditional reference diets such as the Mediterranean diet which has proven health benefits  
375 [62].

376 In our study, using comparative risk assessment on the diets, we estimated higher deaths  
377 from cardiovascular diseases with higher consumption of UPF or PF, and lower deaths with  
378 higher consumption of MPF. We were able to identify nutritional factors that contributed to  
379 estimates of avoided or added death. Differences in BMI and energy intake were important  
380 factors for high consumers of MPF and PF, although less than nutritional factors, but they  
381 were more secondary for high consumers of UPF. Estimations of deaths from high  
382 consumption of UPF are therefore poorly attributable to energy intake and BMI but to other  
383 nutritional factors. High consumers of MPF have a dietary pattern that is known to be  
384 associated with lower risk of cardiovascular diseases (fruits, vegetables, nuts, but also fish  
385 and dairy) whereas high consumers of PF and UPF consumed more food groups known to  
386 be associated with higher risk of cardiovascular diseases (refined grains, products rich in  
387 sodium, alcohol, sugar-sweetened beverages, etc.) [63, 64]. Furthermore, adherence to  
388 overall plant-based diet index (PDI) have been associated with a lower risk of cardiovascular  
389 disease, cardiovascular disease mortality and all-cause mortality [65], which is consistent  
390 with our findings since PDI only increased with higher share of MPF, where lower estimates  
391 of death from cardiovascular diseases were observed. Using modelling analysis to predict  
392 the impact of sustainable diets strategies on health, a study found that adopting diets that are  
393 more plant-based would decrease mortality up to 12% [66]. The methodological framework  
394 used in this study was similar to the Epidiet model that we used, although we included more  
395 nutritional factors (24 instead of 9) and only focused on mortality from three diseases.

396 Beyond showing the association between the degree of processing of the foods consumed  
397 and diet quality, the major new finding of this study was that the specific profiles of protein

398 consumption associated with these patterns are an important determinant of the relationship  
399 with diet quality. In particular, the association between the proportion of MPF and most diet  
400 quality criteria were attenuated when adjusting for protein intake and plant protein diversity.  
401 Likewise, the relationships between the proportions of PF and UPF and nutrient adequacy  
402 were attenuated or inversed when adjusting for protein intake and plant protein diversity.

403 Indeed, protein intake is an important determinant of diet quality and this is closely  
404 dependent on the type of protein food consumed [13, 56, 67]. Plant protein intake and plant-  
405 based diets are generally considered as healthy but there are some unhealthful versions of  
406 plant-based diets [15, 16]. This may explain why in our study the consumption of processed  
407 foods was associated with lower dietary quality even though it is accompanied by a higher  
408 intake of plant protein. Plant protein consumed in high consumers of processed foods, mostly  
409 refined grains, may not be an important contributor to diet quality, compared to other sources  
410 such as legumes, nuts and seeds, and plant protein diversity appears as a condition for a  
411 beneficial effect of plant protein, confirming our earlier report [33].

412 We believe that our present findings lend further credence to this viewpoint by showing that  
413 the relationship between patterns of food processing and diet quality are in part linked to the  
414 pattern of plant/animal protein intake. People with a high consumption of MPF have a higher  
415 animal protein intake but this comes from raw sources, and they have a better diversity of  
416 plant protein intake, all of which explain better diet quality. People with a high consumption of  
417 PF would have a better diet quality if the increase in plant protein intake were not at the  
418 expense of its diversity [33]. People with a high consumption of UPF have a lower intake of  
419 protein foods, a lower plant:animal protein intake and are reliant on diverse ultra-processed  
420 foods which taken together have a detrimental effect on their diet quality.

421 More and more consumers are prone to shift towards a more plant-based diet [68, 69], but  
422 this occurs in the context of a food offer that is increasingly dominated by processed and  
423 ultra-processed foods which exert an adverse effect on diet quality. This plant-based shift  
424 may contribute to improving some aspects of sustainability such as the environmental impact

425 of the diet, but the final impact on its quality and on health outcomes will depend to a great  
426 extent on the composition of the plant-based foods and overall diet consumed. Our study has  
427 highlighted two possible better pathways, which consist in either increasing the consumption  
428 of MPF, preferably with a higher plant protein intake, or choosing processed foods that  
429 contribute to an increase in the proportion of plant proteins while maintaining plant protein  
430 diversity and enabling the favorable nutrient package traditionally associated with plant  
431 proteins.

### 432 ***Limitations of the study***

433 One limitation of this study may concern our use of the NOVA classification, where the ultra-  
434 processed foods group is very broad and includes markedly differing foods that have been  
435 ascribed to this group for different reasons (presence of additives or highly technological food  
436 processing). Some food items are also classified according to their method of preparation,  
437 requiring imputations that could be questionable (i.e. systematically considering foods from  
438 fast-food restaurant as industrially processed). However, the NOVA classification has been  
439 largely employed in the literature and its use offers a clear reference when discussing our  
440 results. Another limitation concerns our food composition database. Indeed, a food item with  
441 the same overall label was assigned to different NOVA categories depending on its origin  
442 despite there being a lack of data regarding its composition. Regarding the study size and  
443 generalizability, the present study took advantage of a representative setting in a country  
444 with western dietary patterns and an important share of industrial foods, with a diversity of  
445 patterns. High consumers of MPF and UPF appear to have dietary patterns comparable to  
446 those reported in studies using other samples. High consumers of PF, which represent a  
447 more traditional pattern might be less generalizable, but data are lacking for further analysis  
448 since this NOVA category has been much less studied. Lastly, although the data came from  
449 the latest French national representative survey (in 2014-2015), they may not have been  
450 sufficiently recent to reflect current dietary transitions and the increased use of plant-based  
451 products.

452 **Conclusion**

453 Although the consumption of UPF has been widely studied in recent years, to our knowledge  
454 very few studies have investigated the associations between the consumption of MPF, PF  
455 and diet quality. Using a variety of indices, we found that the consumption of MPF was  
456 associated with higher diet quality whereas the opposite trend was found with consumption  
457 of UPF. We also show that protein consumption patterns differed according to the degree of  
458 food processing, and that it explains part of the associations with diet quality. Higher  
459 consumers of MPF had a higher protein intake, with a lower plant:animal protein ratio, but  
460 they had a healthier plant-based protein intake and a fully favorable dietary pattern. Higher  
461 consumers of PF had higher plant protein intakes but lower plant protein diversity, and a  
462 greater risk of cardiometabolic death. Higher consumers of UPF had a lower protein intake  
463 and poor diet quality on all dimensions, including a markedly higher cardiometabolic risk. We  
464 can thus conclude that healthy plant protein patterns are crucial to a future shift in protein  
465 intake in the context of a food system that is increasingly dominated by ultra-processed  
466 foods.



## References

1. Monteiro CA, Cannon G, Levy R, et al (2016) NOVA. The star shines bright. [Food classification Puclib health] *World Nutrition* 7:28–38
2. Monteiro CA, Cannon G, Levy RB, et al (2019) Ultra-processed foods: what they are and how to identify them. *Public Health Nutr* 22:936–941. <https://doi.org/10.1017/S1368980018003762>
3. Martínez Steele E, Baraldi LG, Louzada ML da C, et al (2016) Ultra-processed foods and added sugars in the US diet: evidence from a nationally representative cross-sectional study. *BMJ Open* 6:e009892. <https://doi.org/10.1136/bmjopen-2015-009892>
4. Rauber F, da Costa Louzada ML, Steele E, et al (2018) Ultra-Processed Food Consumption and Chronic Non-Communicable Diseases-Related Dietary Nutrient Profile in the UK (2008–2014). *Nutrients* 10:587. <https://doi.org/10.3390/nu10050587>
5. Monteiro CA, Moubarac J-C, Cannon G, et al (2013) Ultra-processed products are becoming dominant in the global food system: Ultra-processed products: global dominance. *Obes Rev* 14:21–28. <https://doi.org/10.1111/obr.12107>
6. Monteiro CA, Cannon G, Moubarac J-C, et al (2018) The UN Decade of Nutrition, the NOVA food classification and the trouble with ultra-processing. *Public Health Nutr* 21:5–17. <https://doi.org/10.1017/S1368980017000234>
7. Martínez Steele E, Raubenheimer D, Simpson SJ, et al (2018) Ultra-processed foods, protein leverage and energy intake in the USA. *Public Health Nutr* 21:114–124. <https://doi.org/10.1017/S1368980017001574>
8. Gerber PJ, Food and Agriculture Organization of the United Nations (2013) Tackling climate change through livestock: a global assessment of emissions and mitigation opportunities. Food and Agriculture Organization of the United Nations, Rome
9. Wu G, Fanzo J, Miller DD, et al (2014) Production and supply of high-quality food protein for human consumption: sustainability, challenges, and innovations: Sustainability, challenge and innovations. *Ann NY Acad Sci* 1321:1–19. <https://doi.org/10.1111/nyas.12500>
10. Springmann M, Clark M, Mason-D’Croz D, et al (2018) Options for keeping the food system within environmental limits. *Nature* 562:519–525. <https://doi.org/10.1038/s41586-018-0594-0>
11. Willett W, Rockström J, Loken B, et al (2019) Food in the Anthropocene: the EAT–Lancet Commission on healthy diets from sustainable food systems. *The Lancet* 393:447–492. [https://doi.org/10.1016/S0140-6736\(18\)31788-4](https://doi.org/10.1016/S0140-6736(18)31788-4)
12. World Cancer Research Fund, American Institute for Cancer Research. (2018) Diet, nutrition, physical activity and cancer: a global perspective. The third Expert Report
13. Mariotti F (2019) Animal and Plant Protein Sources and Cardiometabolic Health. *Adv Nutr* 10:S351–S366. <https://doi.org/10.1093/advances/nmy110>
14. Song M, Fung TT, Hu FB, et al (2016) Association of Animal and Plant Protein Intake With All-Cause and Cause-Specific Mortality. *JAMA Intern Med* 176:1453. <https://doi.org/10.1001/jamainternmed.2016.4182>

15. Satija A, Bhupathiraju SN, Spiegelman D, et al (2017) Healthful and Unhealthful Plant-Based Diets and the Risk of Coronary Heart Disease in U.S. Adults. *J Am Coll Cardiol* 70:411–422. <https://doi.org/10.1016/j.jacc.2017.05.047>
16. Satija A, Bhupathiraju SN, Rimm EB, et al (2016) Plant-Based Dietary Patterns and Incidence of Type 2 Diabetes in US Men and Women: Results from Three Prospective Cohort Studies. *PLoS Med* 13:e1002039. <https://doi.org/10.1371/journal.pmed.1002039>
17. Gehring J, Touvier M, Baudry J, et al (2020) Consumption of Ultra-Processed Foods by Pesco-Vegetarians, Vegetarians, and Vegans: Associations with Duration and Age at Diet Initiation. *J Nutr* nxaa196. <https://doi.org/10.1093/jn/nxaa196>
18. Moodie R, Stuckler D, Monteiro C, et al (2013) Profits and pandemics: prevention of harmful effects of tobacco, alcohol, and ultra-processed food and drink industries. *The Lancet* 381:670–679. [https://doi.org/10.1016/S0140-6736\(12\)62089-3](https://doi.org/10.1016/S0140-6736(12)62089-3)
19. Vandevijvere S, Jaacks LM, Monteiro CA, et al (2019) Global trends in ultraprocessed food and drink product sales and their association with adult body mass index trajectories. *Obesity Reviews* 20:10–19. <https://doi.org/10.1111/obr.12860>
20. Monteiro CA, Cannon G, Lawrence M, et al (2019) Ultra-processed foods, diet quality, and health using the NOVA classification system. *FAO, Rome*
21. Fiolet T, Srour B, Sellem L, et al (2018) Consumption of ultra-processed foods and cancer risk: results from NutriNet-Santé prospective cohort. *BMJ* k322. <https://doi.org/10.1136/bmj.k322>
22. Mendonça R de D, Lopes ACS, Pimenta AM, et al (2016) Ultra-Processed Food Consumption and the Incidence of Hypertension in a Mediterranean Cohort: The Seguimiento Universidad de Navarra Project. *AJHYPE* hpw137. <https://doi.org/10.1093/ajh/hpw137>
23. Nardocci M, Leclerc B-S, Louzada M-L, et al (2019) Consumption of ultra-processed foods and obesity in Canada. *Can J Public Health* 110:4–14. <https://doi.org/10.17269/s41997-018-0130-x>
24. Blanco-Rojo R, Sandoval-Insausti H, López-García E, et al (2019) Consumption of Ultra-Processed Foods and Mortality: A National Prospective Cohort in Spain. *Mayo Clinic Proceedings* 94:2178–2188. <https://doi.org/10.1016/j.mayocp.2019.03.035>
25. Kim H, Hu EA, Rebholz CM (2019) Ultra-processed food intake and mortality in the USA: results from the Third National Health and Nutrition Examination Survey (NHANES III, 1988–1994). *Public Health Nutr* 22:1777–1785. <https://doi.org/10.1017/S1368980018003890>
26. Hall KD, Ayuketah A, Brychta R, et al (2019) Ultra-Processed Diets Cause Excess Calorie Intake and Weight Gain: An Inpatient Randomized Controlled Trial of Ad Libitum Food Intake. *Cell Metabolism* 30:67-77.e3. <https://doi.org/10.1016/j.cmet.2019.05.008>
27. (2017) Opinion of the French Agency for Food, Environmental and Occupational Health & Safety on “the Third Individual and National Survey on Food Consumption (INCA3 Survey).” French Agency for Food, Environmental and Occupational Health Safety (Anses).
28. Dubuisson C, Dufour A, Carrillo S, et al (2019) The Third French Individual and National Food Consumption (INCA3) Survey 2014–2015: method, design and participation rate

- in the framework of a European harmonization process. *Public Health Nutr* 22:584–600. <https://doi.org/10.1017/S1368980018002896>
29. Henry C (2005) Basal metabolic rate studies in humans: measurement and development of new equations. *Public Health Nutr* 8:1133–1152. <https://doi.org/10.1079/PHN2005801>
  30. Black A (2000) Critical evaluation of energy intake using the Goldberg cut-off for energy intake: basal metabolic rate. A practical guide to its calculation, use and limitations. *Int J Obes* 24:1119–1130. <https://doi.org/10.1038/sj.ijo.0801376>
  31. Slimani N, Freisling H, Huybrechts I, et al (2013) Food Consumption Data Collection Methodology for the EU Menu Survey (EMP-PANEU) Final Report. EFSA supporting publication
  32. French Agency for Food, Environmental and Occupational Health & Safety (2016) ANSES-CIQUAL French food composition table version 2016
  33. Salomé M, de Gavelle E, Dufour A, et al (2019) Plant-Protein Diversity Is Critical to Ensuring the Nutritional Adequacy of Diets When Replacing Animal With Plant Protein: Observed and Modeled Diets of French Adults (INCA3). *J Nutr* nxz252. <https://doi.org/10.1093/jn/nxz252>
  34. Drescher LS, Thiele S, Mensink GBM (2007) A New Index to Measure Healthy Food Diversity Better Reflects a Healthy Diet Than Traditional Measures. *The Journal of Nutrition* 137:647–651. <https://doi.org/10.1093/jn/137.3.647>
  35. de Oliveira Otto MC, Padhye NS, Bertoni AG, et al (2015) Everything in Moderation - Dietary Diversity and Quality, Central Obesity and Risk of Diabetes. *PLoS ONE* 10:e0141341. <https://doi.org/10.1371/journal.pone.0141341>
  36. Verger EO, Mariotti F, Holmes BA, et al (2012) Evaluation of a Diet Quality Index Based on the Probability of Adequate Nutrient Intake (PANDiet) Using National French and US Dietary Surveys. *PLoS ONE* 7:e42155. <https://doi.org/10.1371/journal.pone.0042155>
  37. de Gavelle E, Huneau J-F, Foullet H, Mariotti F (2019) The Initial Dietary Pattern Should Be Considered when Changing Protein Food Portion Sizes to Increase Nutrient Adequacy in French Adults. *The Journal of Nutrition* 149:488–496. <https://doi.org/10.1093/jn/nxy275>
  38. Anses (2016) Actualisation des repères du PNNS : élaboration des références nutritionnelles. French Agency for Food, Environmental and Occupational Health Safety (Anses)., Maisons-Alfort, France
  39. Anses (2019) Anses Opinion on the updating of the PNNS dietary guidelines for women from menopause and men over 65 years of age. French Agency for Food, Environmental and Occupational Health Safety (Anses)., Maisons-Alfort, France
  40. Murray CJL, Lopez AD (2013) Measuring the Global Burden of Disease. *N Engl J Med* 369:448–457. <https://doi.org/10.1056/NEJMra1201534>
  41. Kesse-Guyot E, Chaltiel D, Wang J, et al (2020) Sustainability analysis of French dietary guidelines using multiple criteria. *Nat Sustain* 3:377–385. <https://doi.org/10.1038/s41893-020-0495-8>

42. Aune D, Giovannucci E, Boffetta P, et al (2017) Fruit and vegetable intake and the risk of cardiovascular disease, total cancer and all-cause mortality—a systematic review and dose-response meta-analysis of prospective studies. *International Journal of Epidemiology* 46:1029–1056. <https://doi.org/10.1093/ije/dyw319>
43. Micha R, Peñalvo JL, Cudhea F, et al (2017) Association Between Dietary Factors and Mortality From Heart Disease, Stroke, and Type 2 Diabetes in the United States. *JAMA* 317:912. <https://doi.org/10.1001/jama.2017.0947>
44. Scarborough P, Harrington RA, Mizdrak A, et al (2014) The Preventable Risk Integrated ModEl and Its Use to Estimate the Health Impact of Public Health Policy Scenarios. *Scientifica* 2014:1–21. <https://doi.org/10.1155/2014/748750>
45. Inserm CépiDC Classification internationale des maladies (CIM). In: CépiDC Internet. <https://www.cephdc.inserm.fr/causes-medicales-de-deces/classification-internationale-des-maladies-cim>. Accessed 26 Feb 2019
46. Insee Évolution et structure de la population en 2014. In: Insee Internet. <https://www.insee.fr/fr/statistiques/2862200>. Accessed 26 Feb 2019
47. CépiDc (2019) Causes Médicales des Décès en 2014. <https://www.cephdc.inserm.fr/causes-medicales-de-deces/interroger-les-donnees-de-mortalite> . Accessed 26 Feb 2019
48. Thiébaud A, Kesse E, Com-Nougé C, et al (2004) Ajustement sur l'apport énergétique dans l'évaluation des facteurs de risque alimentaires. *Revue d'Épidémiologie et de Santé Publique* 52:539–557. [https://doi.org/10.1016/S0398-7620\(04\)99093-1](https://doi.org/10.1016/S0398-7620(04)99093-1)
49. Willett WC, Howe GR, Kushi LH (1997) Adjustment for total energy intake in epidemiologic studies. *The American Journal of Clinical Nutrition* 65:1220S-1228S. <https://doi.org/10.1093/ajcn/65.4.1220S>
50. Saltelli A, Ratto M, Andres T, et al (2008) *Global Sensitivity Analysis: The Primer*. John Wiley & Sons, Chichester
51. Adams J, White M (2015) Characterisation of UK diets according to degree of food processing and associations with socio-demographics and obesity: cross-sectional analysis of UK National Diet and Nutrition Survey (2008–12). *Int J Behav Nutr Phys Act* 12:160. <https://doi.org/10.1186/s12966-015-0317-y>
52. Julia C, Martinez L, Allès B, et al (2018) Contribution of ultra-processed foods in the diet of adults from the French NutriNet-Santé study. *Public Health Nutr* 21:27–37. <https://doi.org/10.1017/S1368980017001367>
53. Baraldi LG, Martinez Steele E, Canella DS, Monteiro CA (2018) Consumption of ultra-processed foods and associated sociodemographic factors in the USA between 2007 and 2012: evidence from a nationally representative cross-sectional study. *BMJ Open* 8:e020574. <https://doi.org/10.1136/bmjopen-2017-020574>
54. Machado PP, Steele EM, Louzada ML da C, et al (2019) Ultra-processed food consumption drives excessive free sugar intake among all age groups in Australia. *Eur J Nutr*. <https://doi.org/10.1007/s00394-019-02125-y>

55. Baker P, Machado P, Santos T, et al (2020) Ultra-processed foods and the nutrition transition: Global, regional and national trends, food systems transformations and political economy drivers. *Obesity Reviews* 21:. <https://doi.org/10.1111/obr.13126>
56. de Gavelle E, Huneau J-F, Mariotti F (2018) Patterns of Protein Food Intake Are Associated with Nutrient Adequacy in the General French Adult Population. *Nutrients* 10:226. <https://doi.org/10.3390/nu10020226>
57. Gazan R, Béchaux C, Crépet A, et al (2016) Dietary patterns in the French adult population: a study from the second French national cross-sectional dietary survey (INCA2) (2006–2007). *Br J Nutr* 116:300–315. <https://doi.org/10.1017/S0007114516001549>
58. Louzada ML da C, Ricardo CZ, Steele EM, et al (2018) The share of ultra-processed foods determines the overall nutritional quality of diets in Brazil. *Public Health Nutr* 21:94–102. <https://doi.org/10.1017/S1368980017001434>
59. Martínez Steele E, Popkin BM, Swinburn B, Monteiro CA (2017) The share of ultra-processed foods and the overall nutritional quality of diets in the US: evidence from a nationally representative cross-sectional study. *Popul Health Metrics* 15:6. <https://doi.org/10.1186/s12963-017-0119-3>
60. Rauber F, Louzada ML da C, Martinez Steele E, et al (2019) Ultra-processed foods and excessive free sugar intake in the UK: a nationally representative cross-sectional study. *BMJ Open* 9:e027546. <https://doi.org/10.1136/bmjopen-2018-027546>
61. Rauber F, Chang K, Vamos EP, et al (2020) Ultra-processed food consumption and risk of obesity: a prospective cohort study of UK Biobank. *Eur J Nutr*. <https://doi.org/10.1007/s00394-020-02367-1>
62. Salas-Salvadó J, Becerra-Tomás N, García-Gavilán JF, et al (2018) Mediterranean Diet and Cardiovascular Disease Prevention: What Do We Know? *Prog Cardiovasc Dis* 61:62–67. <https://doi.org/10.1016/j.pcad.2018.04.006>
63. Anand SS (2015) Food Consumption and its Impact on Cardiovascular Disease: Importance of Solutions Focused on the Globalized Food System: A Report From the Workshop Convened by the World Heart Federation. *Cardiovascular Disease* 66:25
64. Petersen KS, Flock MR, Richter CK, et al (2017) Healthy Dietary Patterns for Preventing Cardiometabolic Disease: The Role of Plant-Based Foods and Animal Products. *Curr Dev Nutr* 1:cdn.117.001289. <https://doi.org/10.3945/cdn.117.001289>
65. Kim H, Caulfield LE, Garcia-Larsen V, et al (2019) Plant-Based Diets Are Associated With a Lower Risk of Incident Cardiovascular Disease, Cardiovascular Disease Mortality, and All-Cause Mortality in a General Population of Middle-Aged Adults. *JAHA* 8:. <https://doi.org/10.1161/JAHA.119.012865>
66. Springmann M, Wiebe K, Mason-D’Croz D, et al (2018) Health and nutritional aspects of sustainable diet strategies and their association with environmental impacts: a global modelling analysis with country-level detail. *The Lancet Planetary Health* 2:e451–e461. [https://doi.org/10.1016/S2542-5196\(18\)30206-7](https://doi.org/10.1016/S2542-5196(18)30206-7)
67. Tian S, Xu Q, Jiang R, et al (2017) Dietary Protein Consumption and the Risk of Type 2 Diabetes: A Systematic Review and Meta-Analysis of Cohort Studies. *Nutrients* 9:982. <https://doi.org/10.3390/nu9090982>

68. Sanchez-Sabate R, Badilla-Briones Y, Sabaté J (2019) Understanding Attitudes towards Reducing Meat Consumption for Environmental Reasons. A Qualitative Synthesis Review. *Sustainability* 11:6295. <https://doi.org/10.3390/su11226295>
69. Malek L, Umberger WJ, Goddard E (2019) Committed vs. uncommitted meat eaters: Understanding willingness to change protein consumption. *Appetite* 138:115–126. <https://doi.org/10.1016/j.appet.2019.03.024>

**Table 1** Estimated effect of substituting unprocessed/minimally processed foods (MPF) with processed culinary ingredients, processed foods (PF) or ultra-processed foods (UPF) on the PANDiet, hPDI and uPDI diet quality scores under a mutually adjusted multivariate substitution model<sup>a</sup>.

	PANDiet		hPDI		uPDI	
	$\beta$ (95% CI)	<i>P</i>	$\beta$ (95% CI)	<i>P</i>	$\beta$ (95% CI)	<i>P</i>
Proportion of total energy intake from PF <sup>b</sup>	-0.11 (-0.14, -0.09)	<0.001	0.00 (-0.03, 0.03)	0.871	0.12 (0.09, 0.16)	<0.001
Proportion of total energy intake from UPF <sup>b</sup>	-0.16 (-0.19, -0.14)	<0.001	-0.05 (-0.08, -0.03)	<0.001	0.13 (0.10, 0.16)	<0.001

<sup>a</sup>Data from the Individual and National Study on Food Consumption Survey 3, n=1774. Values are regression coefficients (95% CIs) estimated with multiple linear regressions. Data were collected by three 24h recalls.

<sup>b</sup>Model where the proportion of processed culinary ingredients, PF and UPF in the diet were included for mutual adjustment. The proportion of MPF was not included since it was taken as a reference for substitution. The model was adjusted for total energy intake, age, sex, educational level, occupational status, city size, perception of financial status, season of record, region of France and matrimonial status. The association with the proportion of processed culinary ingredients in the diet is not presented since it seems unlikely to substitute foods with culinary ingredients.

hPDI, healthy Plant-based Diet Index; NS, non-significant; PANDiet, Probability of Adequate Nutrient Intake in the Diet; PF, processed foods; uPDI, unhealthy Plant-based diet Index; UPF, ultra-processed foods.

**Table 2** Associations between the PANDiet, hPDI and uPDI diet quality scores and variables of the NOVA classification (proportion of total energy intake from unprocessed/minimally processed foods (MPF), processed foods (PF) and ultra-processed foods (UPF)) using multivariate models adjusted for the characteristics of protein intake, in the French adult population<sup>a</sup>.

	PANDiet		hPDI		uPDI	
	$\beta$ (95% CI)	<i>P</i>	$\beta$ (95% CI)	<i>P</i>	$\beta$ (95% CI)	<i>P</i>
Proportion of total energy intake from MPF						
Basic model <sup>b</sup>	0.14 (0.12, 0.16)	<0.001	0.04 (0.01, 0.06)	0.003	-0.13 (-0.15, -0.10)	<0.001
Controlling for protein intake <sup>c</sup>	0.10 (0.08, 0.12)	<0.001	0.06 (0.03, 0.08)	<0.001	-0.10 (-0.13, -0.07)	<0.001
Controlling for BI-PBF <sup>d</sup>	0.12 (0.10, 0.14)	<0.001	0.00 (-0.03, 0.02)	0.850	-0.07 (-0.10, -0.04)	<0.001
Controlling for protein intake + BI-PBF <sup>e</sup>	0.07 (0.05, 0.09)	<0.001	0.00 (-0.02, 0.03)	0.771	-0.04 (-0.06, -0.01)	0.004
Proportion of total energy intake from PF						
Basic model <sup>b</sup>	0.02 (-0.02, 0.02)	0.965	0.02 (0.00, 0.05)	0.084	0.04 (0.02, 0.07)	0.002
Controlling for protein intake <sup>c</sup>	-0.08 (-0.11, -0.06)	<0.001	-0.03 (-0.05, 0.00)	0.045	0.06 (0.04, 0.09)	<0.001
Controlling for BI-PBF <sup>d</sup>	0.05 (0.03, 0.08)	<0.001	0.11 (0.08, 0.13)	<0.001	-0.07 (-0.10, -0.04)	<0.001
Controlling for protein intake + BI-PBF <sup>e</sup>	-0.04 (-0.06, -0.01)	0.002	0.06 (0.04, 0.09)	<0.001	-0.04 (-0.07, -0.01)	0.005
Proportion of total energy intake from UPF						
Basic model <sup>b</sup>	-0.05 (-0.07, -0.04)	<0.001	-0.07 (-0.09, -0.05)	<0.001	0.06 (0.04, 0.08)	<0.001
Controlling for protein intake <sup>c</sup>	-0.01 (-0.03, 0.00)	0.151	-0.05 (-0.07, -0.03)	<0.001	0.05 (0.03, 0.08)	<0.001
Controlling for BI-PBF <sup>d</sup>	-0.06 (-0.08, -0.05)	<0.001	-0.09 (-0.11, -0.07)	<0.001	0.08 (0.06, 0.10)	<0.001
Controlling for protein intake + BI-PBF <sup>e</sup>	-0.02 (-0.04, 0.00)	0.024	-0.06 (-0.08, -0.04)	<0.001	0.07 (0.05, 0.09)	<0.001

<sup>a</sup>Data from the Individual and National Study on Food Consumption Survey 3, n=1774. Values are regression coefficients (95% CIs) estimated with multiple linear regressions. Data were collected by three 24h recalls.

<sup>b</sup>Basic model adjusted for total energy intake, age, sex, educational level, occupational status, city size, perception of financial status, season of record, region of France and matrimonial status.

<sup>c</sup>Basic model further adjusted for animal protein and plant protein intakes, both being energy-adjusted using the residual method.

<sup>d</sup>Basic model further adjusted for plant protein diversity, evaluated with the BI-PBF score.

<sup>e</sup>Basic model further adjusted for animal protein and plant protein intakes and plant protein diversity (BI-PBF score).

BI-PBF, Berry-Index – Plant-based families; hPDI, healthy Plant-based Diet Index; MPF, unprocessed/minimally processed foods; NS, non-significant; PANDiet, Probability of Adequate Nutrient Intake; PF, processed foods; uPDI, unhealthy Plant-based diet Index; UPF, ultra-processed foods.



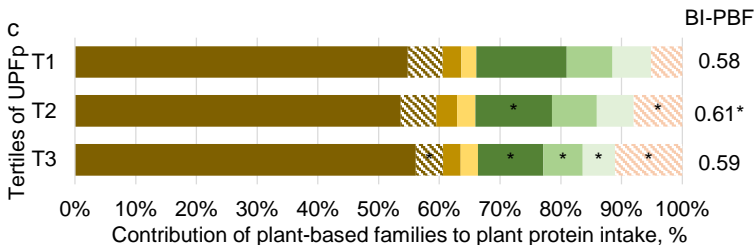
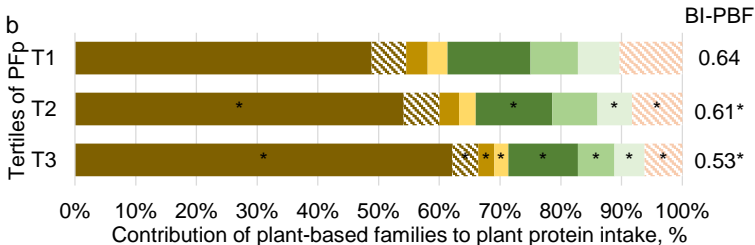
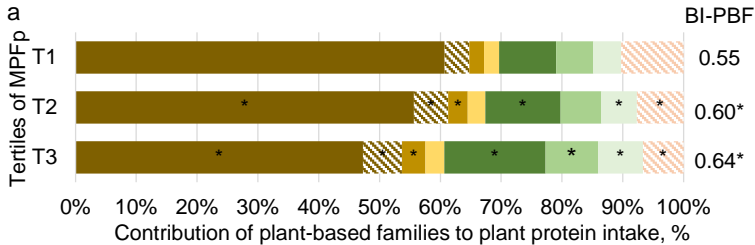

Refined grains

Whole grains

Nuts and seeds

Legumes

Vegetables



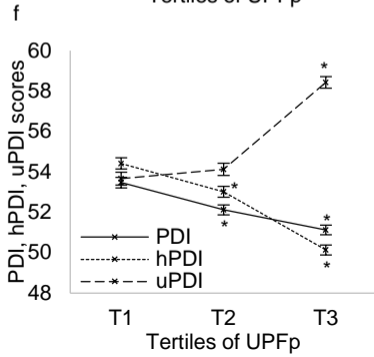
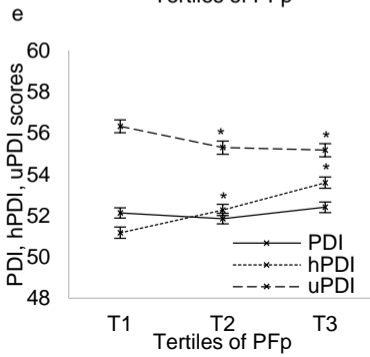
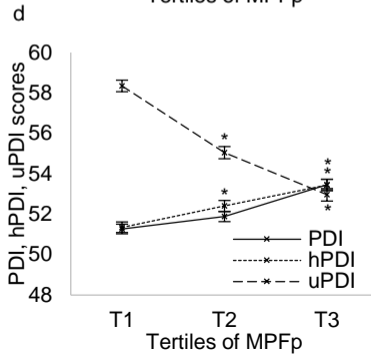
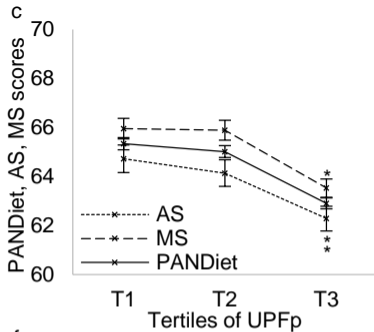
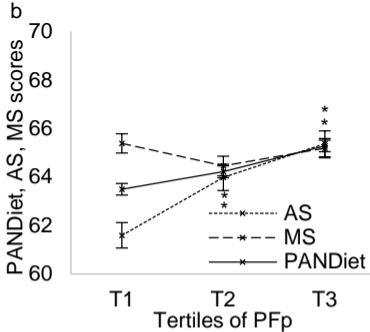
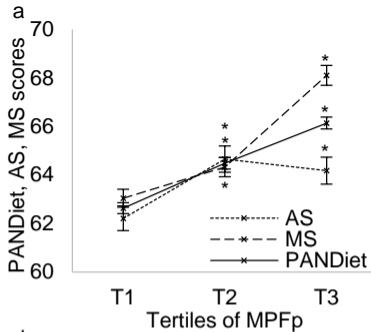

Potatoes

Fruits

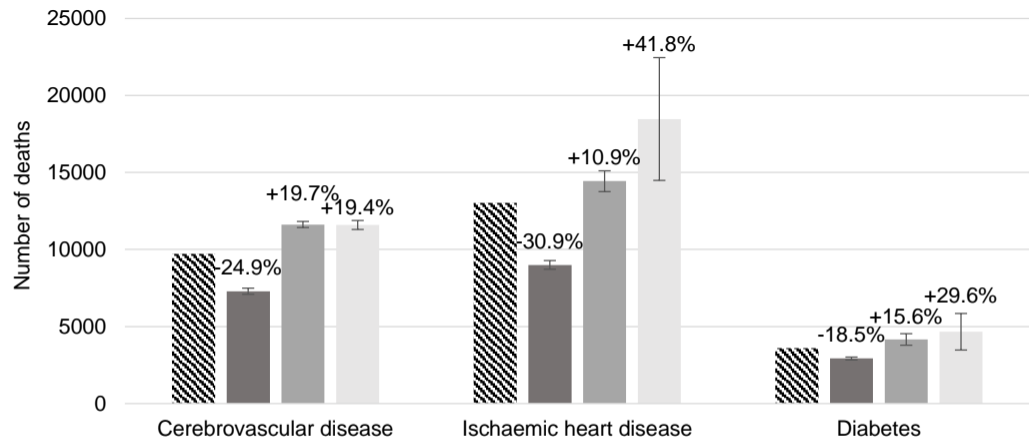
Other plant foods





 Annual number of deaths observed in the French population  
 Estimated number of deaths from a simulated shift of the population's diet towards  
 A higher share of total energy intake from MPF  
 A higher share of total energy intake from PF  
 A higher share of total energy intake from UPF

**Contrary to ultra-processed foods, the consumption of unprocessed or minimally processed foods is associated with favorable patterns of protein intake, diet quality and lower cardiometabolic risk in French adults (INCA3).**

**Marion Salomé<sup>1</sup>, Laura Arrazat<sup>1</sup>, Juhui Wang<sup>1</sup>, Ariane Dufour<sup>2</sup>, Carine Dubuisson<sup>2</sup>, Jean-Luc Volatier<sup>2</sup>, Jean-François Huneau<sup>1</sup>, François Mariotti<sup>1\*</sup>**

<sup>1</sup>Université Paris-Saclay, AgroParisTech, INRAE, UMR PNCA, 75005, Paris, France

<sup>2</sup>Risk Assessment Department, Methodology and Survey Unit, French Agency for Food, Environmental and Occupational Health & Safety (ANSES), 14 rue Pierre et Marie Curie, 94701 Maisons-Alfort Cedex, France

\* Corresponding author: François Mariotti, 16 rue Claude Bernard, 75005 Paris, France, francois.mariotti@agroparistech.fr

**Supplementary Table S1** Reference values of the PANDiet scoring system.

PANDiet score <sup>1</sup>			
Average of Adequacy and Moderation subscores			
Adequacy subscore			
Nutrient	Reference value (/day) <sup>2</sup>	Variability	Source
<b>Protein</b>	0.66 or 0.8 g/kg bw	12.5%	[1]
<b>LA</b>	3.08% EIEA	15%	[3]
<b>ALA</b>	0.769% EIEA	15%	[3]
<b>DHA</b>	0.192 g	15%	[3]
<b>EPA + DHA</b>	0.385 g	15%	[3]
<b>Fiber</b>	23 g	15%	[2]
<b>Vitamin A</b>	570 or 490 µg	15%	[2]
<b>Thiamin</b>	0.3 mg/1000 kcal	20%	[4]
<b>Riboflavin</b>	1.3 mg	15%	[4]
<b>Niacin</b>	5.44 mg NE/1000kcal	10%	[2]
<b>Pantothenic acid</b>	3.62 or 2.94 mg	30%	[2]
<b>Vitamin B-6</b>	1.5 or 1.3 mg	10%	[5]
<b>Folate</b>	250 µg	15%	[2]
<b>Vitamin B-12</b>	3.33 µg	10%	[2]
<b>Vitamin C</b>	90 mg	10%	[2]
<b>Vitamin D</b>	10 µg	25%	[2]
<b>Vitamin E</b>	5.8 or 5.5 mg	40%	[2]
<b>Calcium</b>	860 (<= 24 y.o) or 750 (>24 y.o.)	15% or 13%	[2]
<b>Copper</b>	1.0 or 0.8 mg	15%	[2]
<b>Iodine</b>	107 µg	20%	[2]
<b>Bioavailable iron</b>	See formula in de Gavelle et al. (7)		[2]
<b>Magnesium</b>	5 mg/kg bw	15%	[2]
<b>Manganese</b>	1.56 or 1.39 mg	40%	[2]
<b>Phosphorus</b>	Calcium (mmol) / 1.65 c.f. phosphorus section in de Gavelle et al. [6]	7.5% + CV Calcium (mg)	[4]
<b>Potassium</b>	2692 mg	15%	[4]
<b>Selenium</b>	54 µg	15%	[2]
<b>Bioavailable zinc</b>	0.642 + 0.038 b.w.	10%	[2]

Moderation subscore			
Nutrient	Reference value (/day)	Variability	Source
<b>Protein</b>	2.2 g/kg bw	12.5%	[2]
<b>Total fat</b>	44% EIEA	5%	[2]
<b>SFA</b>	12% EIEA	15%	[2]
<b>Carbohydrates</b>	60.5% EIEA	5%	[2]
<b>Sugars (without lactose)</b>	100 g	15%	[2]
<b>Sodium</b>	3482 or 2618 mg	40%	[2]

Tolerable Upper Intake Limits		Source
<b>Vitamin A (retinol only)</b>	3000 µg	[2]
<b>Niacin</b>	900 mg	[2]
<b>Vitamin B6</b>	25 mg	[2]
<b>Folate</b>	1170 µg	[2]
<b>Vitamin D</b>	100 µg	[2]
<b>Vitamin E</b>	300 mg	[2]
<b>Calcium</b>	2500 mg	[2]
<b>Copper</b>	10 mg	[2]
<b>Iodine</b>	600 µg	[2]
<b>Dissociable magnesium</b>	250 mg	[2]
<b>Selenium</b>	300 µg	[2]
<b>Zinc</b>	25 mg	[2]

<sup>1</sup>The PANDiet score is expressed as the average of an adequacy subscore (AS – accounting for 27 nutrients) and a moderation subscore (MS – accounting for six nutrients, plus 12 potential penalty values). DHA and EPA+DHA are weighted by a factor of 1/2 as DHA is present twice. Niacin equivalents were calculated as the sum of dietary niacin and 1/60 dietary tryptophan. The complete construction of the score has been described elsewhere [7, 8].

<sup>2</sup>The PANDiet 3.1 version is mainly based on the dietary reference intake from the 2016 Anses opinion [2]. PANDiet was modified from its previous version [8] in order to be used also in older adults [9]. According to ANSES opinion, the reference values for vitamins and minerals and the contribution of macronutrients to energy intake are similar to those of adults. Only protein intake should be higher (with a population reference intake of 1 g/kg/d vs 0.83 g/kg/d for younger adults). The reference value for proteins was therefore adapted for adults over the age of 65y.

ALA, alpha-linolenic acid; bw, body weight; CV, coefficient of variation; DHA, docosahexaenoic acid; EIEA, energy intake excluding alcohol; EPA, eicosapentaenoic acid; LA, linoleic acid; NE, niacin equivalent; SFA, saturated fatty acids.

**Supplementary Table S2** Food groups used to calculate PDI scores, and scoring system, as proposed by Satija et al. [10, 11]

	<b>Overall plant-based diet index (PDI) (18-90 points)</b>	<b>Healthy plant-based diet index (hPDI) (18-90 points)</b>	<b>Unhealthy plant-based diet index (uPDI) (18-90 points)</b>
<b>Plant Food Groups<sup>1</sup></b>			
Healthy			
Whole grains	Positive scores <sup>2</sup>	Positive scores	Reverse scores <sup>3</sup>
Fruits	Positive scores	Positive scores	Reverse scores
Vegetables	Positive scores	Positive scores	Reverse scores
Nuts	Positive scores	Positive scores	Reverse scores
Legumes	Positive scores	Positive scores	Reverse scores
Vegetable oils	Positive scores	Positive scores	Reverse scores
Tea and coffee	Positive scores	Positive scores	Reverse scores
Less healthy			
Fruit juices	Positive scores	Reverse scores	Positive scores
Refined grains	Positive scores	Reverse scores	Positive scores
Potatoes	Positive scores	Reverse scores	Positive scores
Sugar sweetened beverages	Positive scores	Reverse scores	Positive scores
Sweets and desserts	Positive scores	Reverse scores	Positive scores
<b>Animal Food Groups</b>			
Animal fats	Reverse scores	Reverse scores	Reverse scores
Dairy	Reverse scores	Reverse scores	Reverse scores
Eggs	Reverse scores	Reverse scores	Reverse scores
Fish or seafood	Reverse scores	Reverse scores	Reverse scores
Meat	Reverse scores	Reverse scores	Reverse scores
Miscellaneous animal-based foods	Reverse scores	Reverse scores	Reverse scores

<sup>1</sup>Each food item was attributed to a food group (mixed foods were broken down into ingredients which were then attributed to a food group). The mean quantity of each food group consumed each day per individual was worked out instead of the frequencies of consumption, because our data came from 24h recalls and not a FFQ, as was the case in the study by Satija et al. The consumption of each food group was stratified into quintiles among participants. For each food group, a score between 1 and 5 was applied.

<sup>2</sup>For positive scores, the highest scores were attributed to the individuals in the highest consumption quintiles (i.e. 5 points for the 5<sup>th</sup> quintile to 1 point for the 1<sup>st</sup> quintile).

<sup>3</sup>For reverse scores, individuals in the higher quintiles received fewer points than individuals in the lower quintiles (i.e. 1 point for the 5<sup>th</sup> quintile to 5 points for the 1<sup>st</sup> quintile).

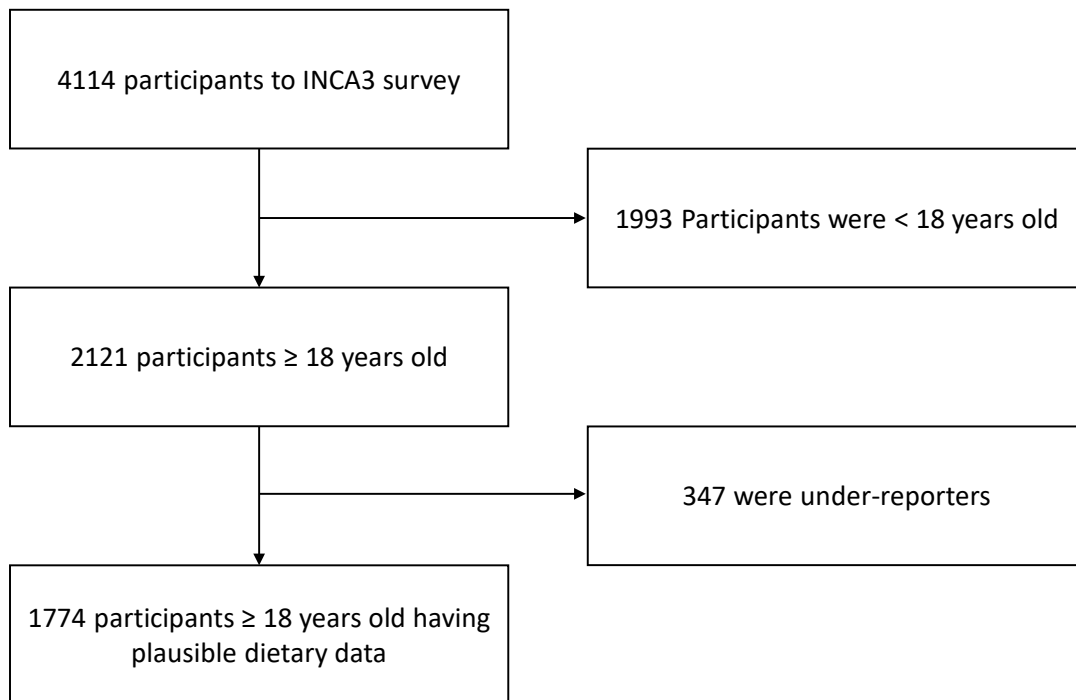

**Supplementary Figure S1** Flow chart explaining the sampling of French participants from the third Individual and National Study on Food Consumption Survey (INCA3).

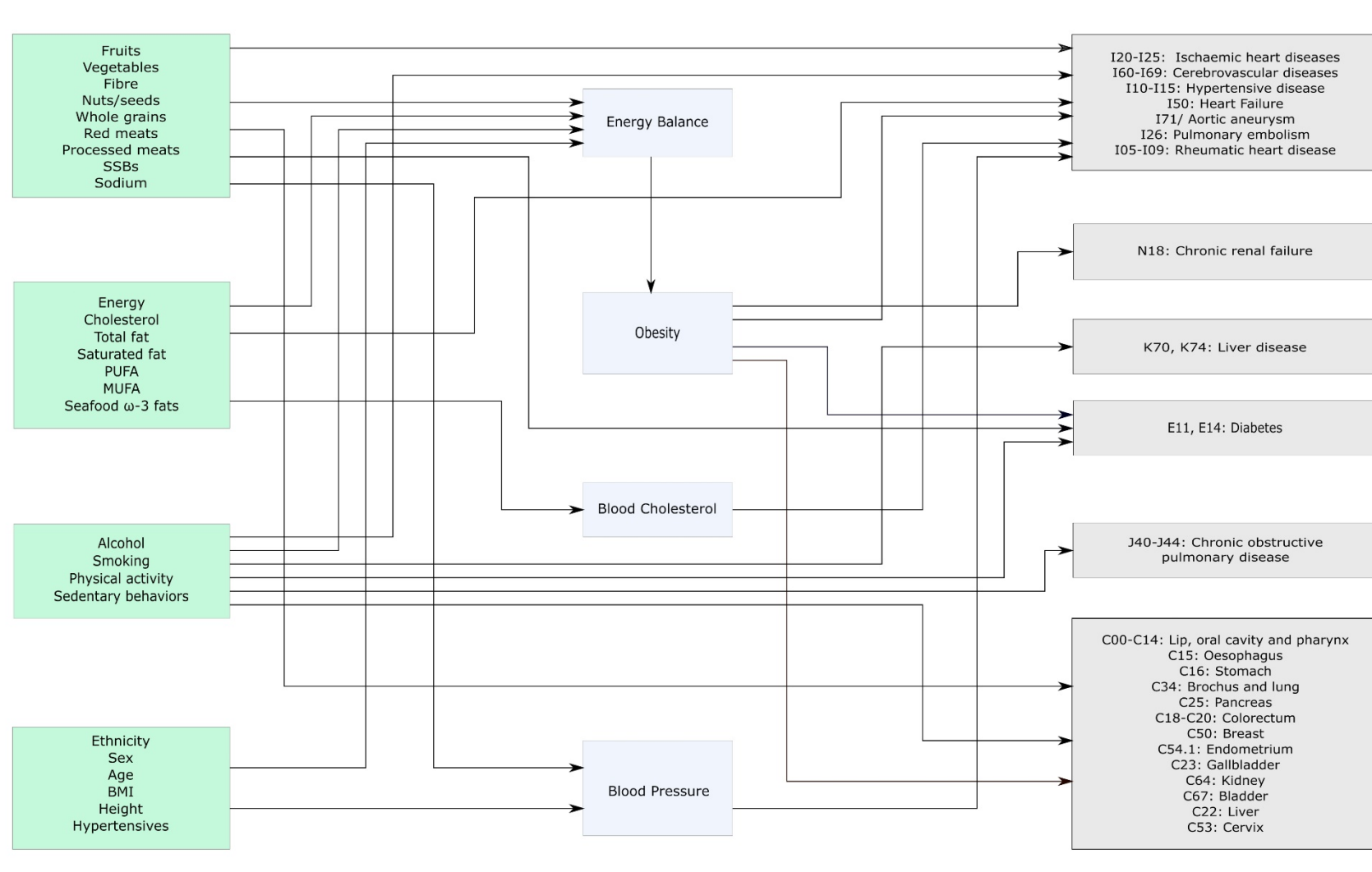

**Supplementary Figure S2** A conceptual framework showing the relationship between the risk factors and the disease outcomes, implemented in the EpiDiet model. The left column lists the risk factors considered (foods, macro and micro-nutrients, behaviors and anthropometric measurements), and the right the diseases taken into account in the model. In the middle are listed the mechanistic or statistical models implemented in EpiDiet to formulate the hypotheses on the mediator factors.



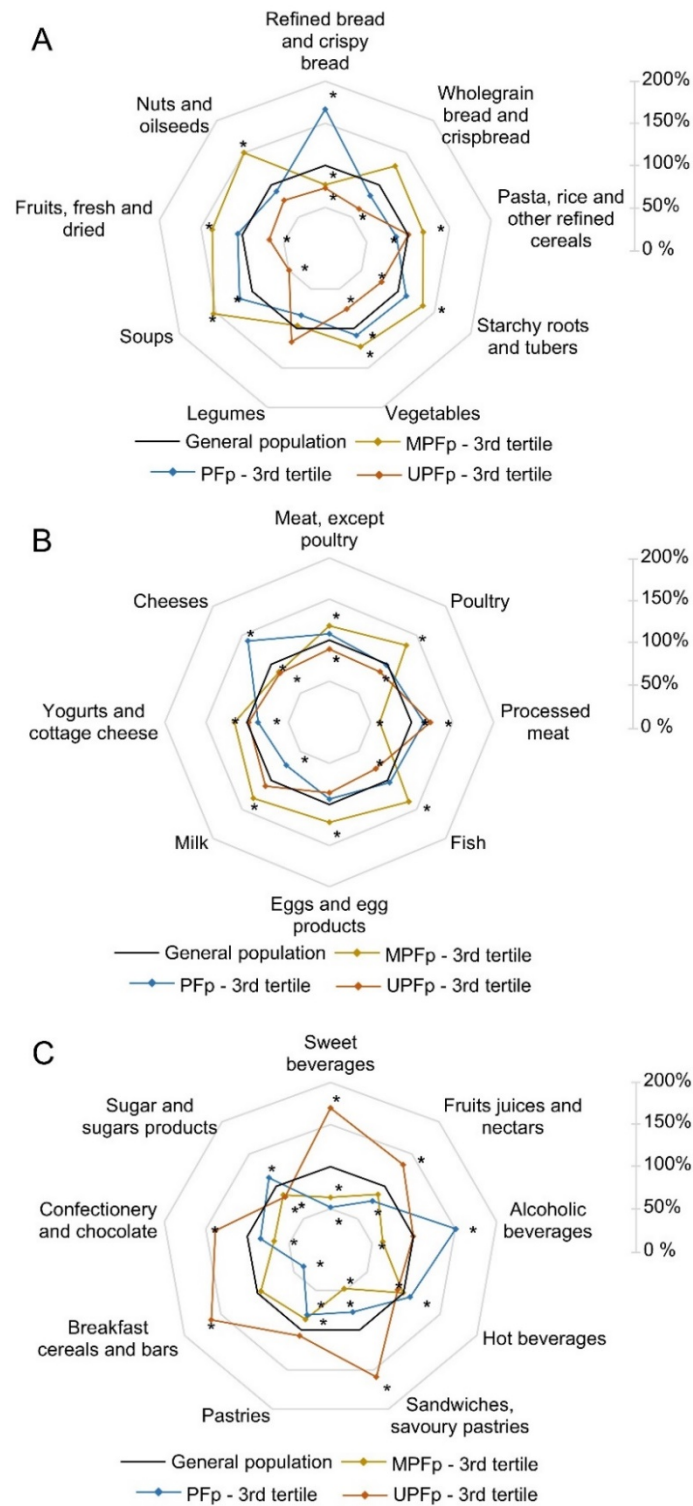

**Supplementary Figure S3** Relative mean intake of A. Plant-based food groups, B. Animal-based food groups and C. Miscellaneous food groups in the third tertiles of the proportion of unprocessed/minimally processed foods in the diet (MPFp-3<sup>rd</sup> tertile, n=591), the proportion of processed foods in the diet (PFp-3<sup>rd</sup> tertile, n=591) and the proportion of ultra-processed foods in the diet (UPFp-3<sup>rd</sup> tertile, n=591) shown as a percentage compared to Is-mean intake in the INCA3 population (n=1774), taken as the reference at 100%. Means are adjusted for the season of recall. \* indicates significant difference vs. the general population. Between-subject variability is not shown for the sake of clarity.

**Supplementary Table S3** Contingency table showing the frequency distribution (across tertiles) of the proportion of energy from unprocessed/minimally processed foods (MPF), processed foods (PF) and ultra-processed foods (UPF) in the diet of the French adult population<sup>a</sup>.

			Proportion of total energy intake from PF			Proportion of total energy intake from UPF		
			Tertile 1 (n=591)	Tertile 2 (n=592)	Tertile 3 (n=591)	Tertile 1 (n=591)	Tertile 2 (n=592)	Tertile 3 (n=591)
Proportion of total energy intake from MPF	Tertile 1 (n=591)	n	136	186	269	87	150	354
		%	7.67	10.48	15.16	4.9	8.46	19.95
	Tertile 2 (n=592)	n	168	193	231	181	235	176
		%	9.47	10.88	13.02	10.2	13.25	9.92
	Tertile 3 (n=591)	n	287	213	91	323	207	61
		%	16.18	12.01	5.13	18.21	11.67	3.44
Proportion of total energy intake from UPF	Tertile 1 (n=591)	n	103	169	319			
		%	5.81	9.53	17.98			
	Tertile 2 (n=592)	n	173	222	197			
		%	9.75	12.51	11.1			
	Tertile 3 (n=591)	n	315	201	75			
		%	17.76	11.33	4.23			

<sup>a</sup>Data from the Individual and National Study on Food Consumption Survey 3, n=1774. MPF, unprocessed/minimally processed foods; PF, processed foods; UPF, ultra-processed foods.

**Supplementary Table S4** Sociodemographic characteristics according to tertiles of the proportion of unprocessed/minimally processed foods (MPF), processed foods (PF) and ultra-processed foods (UPF) in the diet of the French adult population<sup>a</sup>.

	All population (n=1774)	Proportion of total energy intake from MPF				Proportion of total energy intake from PF				Proportion of total energy intake from UPF			
		T1 (n=591) 1.01- 27.66%	T2 (n=592) 27.67- 37.68%	T3 (n=591) 37.69- 76.91%	P	T1 (n=591) 0.00- 19.58%	T2 (n=592) 19.59- 30.21%	T3 (n=591) 30.22- 69.47%	P	T1 (n=591) 0.12- 20.62%	T2 (n=592) 20.68- 34.06%	T3 (n=591) 34.13- 78.92%	P
Sex, % males	49.9	56.6	48.9	43.0	<0.001	40.1	48.0	62.2	<0.001	48.5	49.5	51.4	0.603
Age group, %					<0.001				<0.001				<0.001
18-24 y	10.3	13.7	7.8	8.9		19.2	5.4	5.8		4.6	3.6	20.5	
25-34 y	15.9	23.4	12.5	10.5		20.9	15.1	11.5		4.1	15.2	25.7	
35-49 y	30.7	33.5	30.5	27.5		28.1	38.6	25.6		23.7	33.6	33.7	
50-65 y	25.8	20.3	30.1	27.9		21.0	23.1	33.6		34.4	32.0	13.8	
65-79 y	17.4	9.1	19.1	25.3		10.9	17.9	23.6		33.4	15.6	6.3	
Educational level, %					0.417				0.014				<0.001
Primary school	47.0	44.7	47.0	49.7		44.0	44.9	52.1		53.2	47.2	42.0	
Middle school	17.7	17.0	18.3	17.8		21.5	16.9	14.4		15.8	13.2	23.0	
Secondary school	17.4	19.3	17.8	14.7		16.8	18.1	17.3		14.7	18.8	18.3	
College or university	18.0	18.9	17.0	17.9		17.7	20.0	16.2		16.4	20.9	16.7	
Occupational status, %					<0.001				<0.001				<0.001
Employee	15.6	16.9	15.7	13.9		22.9	10.5	13.1		10.0	16.5	19.3	
Manual worker	13.1	14.8	14.1	9.8		13.6	15.1	10.5		7.0	13.1	17.8	
Farmer	0.7	0.6	0.6	0.9		0.1	1.0	0.9		1.0	0.9	0.2	
Craftsman, shopkeeper, business owner	3.3	3.1	3.4	3.5		2.4	2.5	5.2		4.4	4.3	1.7	
Intermediate profession	19.6	22.7	19.3	16.2		16.9	25.3	16.8		12.9	19.8	24.7	
Professional, executive	13.2	14.9	13.5	10.8		10.8	14.2	14.7		12.8	14.8	12.1	
Retired	23.1	13.8	25.7	31.6		14.9	22.5	32.4		44.3	20.5	8.8	
Inactive	11.4	13.1	7.7	13.3		18.5	9.1	6.4		7.6	10.2	15.5	
Region of France, %					0.001				0.005				0.238
Ile-de-France (Paris area)	17.4	16.0	16.3	20.4		18.4	15.7	18.1		17.9	19.1	15.6	
North-West	19.8	22.3	22.3	14.3		17.3	21.9	20.4		17.8	19.9	21.4	
North-East	27.2	26.8	29.9	24.7		28.5	30.5	22.5		24.8	28.5	27.9	
South-East	17.9	19.0	15.2	19.4		19.2	13.6	20.8		19.8	17.2	17.0	
South-West	17.7	16.0	16.3	21.3		16.6	18.3	18.3		19.7	15.3	18.2	
City size, %					<0.001				<0.001				<0.001
Rural	26.1	20.3	31.1	27.7		22.4	25.8	30.3		31.4	28.4	20.0	
2 000-19 999 hab.	17.6	19.8	18.5	14.0		15.5	16.0	21.4		19.0	17.8	16.3	
20 000-99 999 hab.	11.0	9.7	14.0	9.2		12.4	9.5	10.9		11.1	9.3	12.2	
≥100 000 hab.	32.4	37.1	27.0	32.6		33.5	36.9	26.8		25.9	31.7	38.1	
Paris agglomeration	13.0	13.1	9.5	16.5		16.3	11.8	10.7		12.6	12.8	13.4	

<sup>a</sup> Data from the Individual and National Study on Food Consumption Survey 3, n=1774. Values are percentages weighted for the survey design.

\* P values are from  $\chi^2$  test. NS. "Refusals to answer" were included in the statistical test (for Matrimonial status and Perception of financial status)  
MPF, unprocessed/minimally processed foods; NS, nonsignificant; PF, processed foods; T, tertile; UPF, ultra-processed foods; y, years old

**Supplementary Table S4 (continued)**

	All population (n=1774)	Proportion of total energy intake from MPF				Proportion of total energy intake from PF				Proportion of total energy intake from UPF			
		T1 (n=591)	T2 (n=592)	T3 (n=591)	P	T1 (n=591)	T2 (n=592)	T3 (n=591)	P	T1 (n=591)	T2 (n=592)	T3 (n=591)	P
		1.01- 27.66%	27.67- 37.68%	37.69- 76.91%		0.00- 19.58%	19.59- 30.21%	30.22- 69.47%		0.12- 20.62%	20.68- 34.06%	34.13- 78.92%	
Season of record, %					<0.001				<0.001				0.417
<i>Winter</i>	24.5	20.8	21.9	31.8		32.5	22.0	18.7		25.2	24.3	24.1	
<i>Spring</i>	25.0	28.4	23.5	22.7		21.7	26.0	27.7		25.6	25.7	24.0	
<i>Summer</i>	25.6	30.4	25.5	19.9		22.7	27.3	26.9		23.5	23.8	28.7	
<i>Autumn</i>	24.9	20.5	29.2	25.6		23.2	24.8	26.8		25.7	26.2	23.1	
Matrimonial status, %					<0.001				<0.001				<0.001
<i>Single</i>	20.3	22.4	19.3	19.0		29.3	14.7	16.6		12.8	15.3	30.6	
<i>Married</i>	48.9	42.4	49.4	56.2		38.5	52.2	56.6		63.5	56.3	31.2	
<i>Unmarried couple</i>	19.3	24.9	20.8	11.0		20.2	20.0	17.7		11.5	17.8	26.7	
<i>Widowed</i>	3.5	2.6	3.3	4.7		3.6	3.1	3.7		4.5	3.3	2.8	
<i>Separated/divorced</i>	8.0	7.7	7.3	8.9		8.4	10.2	5.3		7.7	7.3	8.8	
<i>Refusal to answer</i>	0.0	0.0	0.0	0.1		0.0	0.0	0.1		0.1	0.0	0.0	
Perception of financial status, %					0.002				0.183				0.027
<i>Financially comfortable</i>	14.7	14.5	15.2	14.4		14.5	15.0	14.7		15.0	16.0	13.4	
<i>It's okay</i>	36.2	33.0	38.5	37.7		35.2	34.4	39.1		39.8	37.2	32.6	
<i>It's tight</i>	10.8	9.3	10.3	13.2		10.7	12.0	9.8		12.0	9.7	10.8	
<i>Manageable if careful</i>	29.5	31.3	31.1	25.5		29.4	30.3	28.7		27.3	28.7	31.8	
<i>Hard to make ends meet</i>	7.9	10.5	4.4	8.4		8.5	7.9	7.3		5.2	7.9	10.0	
<i>Can't manage without debts</i>	0.9	1.4	0.5	0.8		1.9	0.3	0.4		0.6	0.5	1.4	
<i>Refusal to answer</i>	0.0	0.0	0.1	0.0		0.0	0.1	0.0		0.1	0.0	0.0	
Food insufficiency, %					0.005				0.106				<0.001
<i>Food sufficiency</i>	83.2	79.0	85.5	85.9		80.7	83.8	85.2		87.1	84.7	78.9	
<i>Qualitative food insufficiency</i>	14.2	18.2	11.6	12.0		17.1	13.5	11.7		11.6	10.8	19.0	
<i>Quantitative food insufficiency</i>	2.6	2.8	2.9	2.1		2.3	2.6	3.0		1.4	4.5	2.0	
Food insecurity, %					<0.001				0.032				<0.001
<i>Food security</i>	92.1	87.1	96.7	93.2		90.3	91.5	94.5		95.3	94.1	87.9	
<i>Moderate food insecurity</i>	4.9	8.4	1.6	4.0		5.4	6.0	3.1		2.5	3.8	7.6	
<i>Severe food insecurity</i>	3.1	4.4	1.7	2.8		4.3	2.5	2.4		2.2	2.1	4.6	
Body Mass Index (BMI), %					0.005				0.005				0.013
<i>Underweight (BMI&lt;18.5)</i>	3.5	4.0	4.7	1.7		5.1	3.3	2.2		2.4	3.4	4.5	
<i>Normal weight (18.5≤BMI&lt;25)</i>	48.6	50.4	50.9	44.0		52.8	44.7	48.0		44.3	49.1	51.6	
<i>Overweight (25≤BMI&lt;30)</i>	34.8	33.9	32.2	38.6		31.5	37.1	36.0		36.9	34.4	33.4	
<i>Obesity (BMI≥30)</i>	13.1	11.7	12.3	15.7		10.6	15.0	13.8		16.5	13.1	10.5	
BMI, kg/m <sup>2</sup> (mean ± SD)	25.3 ± 4.4	25.1 ± 4.5	25.1 ± 4.4	25.8 ± 4.4		24.6 ± 4.7	25.8 ± 4.4	25.5 ± 4.1		25.8 ± 4.7	25.3 ± 4.2	24.8 ± 4.8	

**Supplementary Table S5** Total, plant and animal protein intakes and distribution of food families to animal or plant protein intake according to tertiles of the proportion of unprocessed/minimally processed foods (MPF), processed foods (PF) and ultra-processed foods (UPF) in the diet of the French adult population<sup>a</sup>.

	All population (n=1774)		Proportion of total energy intake from MPF						Proportion of total energy intake from PF						Proportion of total energy intake from UPF					
			T1 (n=591)		T2 (n=592)		T3 (n=591)		T1 (n=591)		T2 (n=592)		T3 (n=591)		T1 (n=591)		T2 (n=592)		T3 (n=591)	
			1.01-27.66%		27.67-37.68%		37.69-76.91%		0.00-19.58%		19.59-30.21%		30.22-69.47%		0.12-20.62%		20.68-34.06%		34.13-78.92%	
	Mean	SEM	Mean <sup>b</sup>	SEM	Mean	SEM	Mean	SEM	Mean	SEM	Mean	SEM	Mean	SEM	Mean	SEM	Mean	SEM	Mean	SEM
Total protein, g/d	81.7	0.4	76.8	0.7	81.8**	0.7	87.4**	0.7	78.7	0.7	82.2**	0.7	84.2**	0.7	83.3	0.8	82.7	0.7	79.4**	0.7
Animal protein, g/d	55.7	0.5	51.1	0.7	55.8**	0.8	61.0**	0.8	55.0	0.8	57.0	0.8	55.2	0.8	54.9	0.8	56.9	0.8	55.3	0.7
BI-APF	0.73	0.00	0.73	0.00	0.73	0.00	0.71**	0.00	0.72	0.00	0.73	0.00	0.72	0.00	0.71	0.00	0.73*	0.00	0.73**	0.00
Protein from animal-based families, % of animal protein																				
<i>Red meat</i>	24.2	0.5	21.3	0.7	25.3**	0.8	26.5**	0.8	24.8	0.8	24.3	0.8	23.4	0.8	24.2	0.8	25.1	0.8	23.3	0.7
<i>Poultry</i>	13.1	0.4	10.8	0.6	12.4	0.7	16.6**	0.7	14.3	0.6	12.3*	0.7	12.7	0.7	14.6	0.7	13.1	0.7	11.9*	0.6
<i>Processed meat</i>	12.2	0.3	16.9	0.4	11.5**	0.5	7.4**	0.5	10.9	0.5	12.6*	0.5	13.2**	0.5	9.8	0.5	10.9	0.5	15.2**	0.4
<i>Fish</i>	10.9	0.3	7.8	0.5	12.2**	0.6	13.3**	0.6	10.7	0.6	10.8	0.6	11.3	0.6	12.2	0.6	12.3	0.6	8.7**	0.5
<i>Eggs</i>	6.1	0.2	6.3	0.2	6.0	0.3	6.0	0.3	7.1	0.3	6.0*	0.3	5.1**	0.3	6.2	0.3	6.0	0.3	6.1	0.2
<i>Milk</i>	8.8	0.2	9.6	0.4	7.9*	0.4	8.6	0.4	11.2	0.4	8.8**	0.4	6.2**	0.4	6.6	0.4	7.7*	0.4	11.3**	0.4
<i>Cheese</i>	16.3	0.3	19.9	0.5	16.4**	0.5	11.8**	0.5	12.0	0.5	16.6**	0.5	20.4**	0.5	17.4	0.5	15.6*	0.5	15.8*	0.5
<i>Yogurt</i>	6.0	0.2	5.3	0.3	5.8	0.3	7.2**	0.3	7.0	0.3	6.1*	0.3	5.0**	0.3	6.1	0.3	6.7	0.3	5.4	0.3
<i>Offal</i>	1.1	0.1	1.0	0.2	1.2	0.2	1.2	0.2	0.7	0.2	1.3*	0.2	1.4*	0.2	1.4	0.2	1.1	0.2	0.9*	0.2
<i>Game</i>	0.2	0.1	0.1	0.1	0.2	0.1	0.5**	0.1	0.1	0.1	0.1	0.1	0.5*	0.1	0.6	0.1	0.2**	0.1	0.0**	0.1
<i>Other dairy products</i>	1.1	0.0	1.1	0.1	1.2	0.1	0.9*	0.1	1.2	0.1	1.1	0.1	0.9*	0.1	0.9	0.1	1.1*	0.1	1.1*	0.1
Plant protein, g/d	26.0	0.1	25.7	0.2	25.9	0.2	26.4*	0.3	23.7	0.2	25.3**	0.2	29.0**	0.2	28.4	0.2	25.8**	0.2	24.1**	0.2
Plant protein, % of total protein	33.2	0.2	35.0	0.4	33.0**	0.4	31.2**	0.4	31.7	0.4	32.2	0.4	35.7**	0.4	35.3	0.4	32.4**	0.4	32.2**	0.4
BI-PBF	0.59	0.00	0.55	0.01	0.60**	0.01	0.64**	0.01	0.64	0.01	0.61**	0.01	0.53**	0.01	0.58	0.01	0.61*	0.01	0.59	0.01
Protein from plant-based families, % of plant protein																				
<i>Refined grains</i>	55.0	0.4	60.7	0.7	55.7**	0.7	47.3**	0.7	48.8	0.7	54.1**	0.7	62.2**	0.7	54.8	0.8	53.6	0.8	56.1	0.7
<i>Whole grains</i>	5.3	0.2	4.1	0.4	5.6*	0.4	6.4**	0.4	5.7	0.4	5.9	0.4	4.3*	0.4	5.7	0.4	5.9	0.4	4.5*	0.4
<i>Nuts and seeds</i>	3.1	0.1	2.5	0.2	3.2*	0.2	3.8**	0.3	3.5	0.2	3.2	0.2	2.6*	0.2	3.1	0.3	3.4	0.2	2.9	0.2
<i>Legumes</i>	2.8	0.2	2.4	0.3	2.9	0.3	3.1	0.3	3.3	0.3	2.7	0.3	2.3*	0.3	2.5	0.3	3.0	0.3	2.9	0.3
<i>Vegetables</i>	12.6	0.2	9.4	0.3	12.4**	0.3	16.6**	0.3	13.6	0.3	12.6*	0.4	11.4**	0.4	14.9	0.4	12.6**	0.3	10.8**	0.3
<i>Potatoes</i>	7.1	0.2	6.1	0.3	6.7	0.3	8.7**	0.3	7.8	0.3	7.4	0.3	6.0**	0.3	7.5	0.3	7.4	0.3	6.5*	0.3
<i>Fruits</i>	5.9	0.1	4.6	0.2	5.8**	0.2	7.4**	0.2	6.9	0.2	5.7**	0.2	5.0**	0.2	6.3	0.2	6.1	0.2	5.3**	0.2
<i>Other plant foods</i>	8.3	0.2	10.3	0.3	7.7**	0.3	6.7**	0.3	10.3	0.3	8.3**	0.3	6.2**	0.3	5.1	0.3	8.0**	0.3	11.1**	0.2

<sup>a</sup> Data from the Individual and National Study on Food Consumption Survey 3, n=1774. Data were collected by three 24h recalls.

<sup>b</sup> Means adjusted for season of recall and weighted for the survey design. Significantly different from the mean of the first tertile: \*, P<0.05; \*\*, P<0.001; P ≥ 0.05, NS. P for ANOVA tests adjusted for season of recall.

BI-ABF: Berry-Index Animal-based families; BI-PBF: Berry-Index Plant-based families; MPF, unprocessed/minimally processed foods; NS, nonsignificant; PF, processed foods; SEM: standard error of the mean; T, tertile; UPF, ultra-processed foods.

**Supplementary Table S6** PANDiet score and subscores and plant-based diet indices according to tertiles of the proportion of unprocessed/minimally processed foods (MPF), processed foods (PF) and ultra-processed foods (UPF) in the diet of the French adult population<sup>a</sup>.

	All population (n=1774)		Proportion of total energy intake from MPF						Proportion of total energy intake from PF						Proportion of total energy intake from UPF					
			T1 (n=591) 1.01-27.66%		T2 (n=592) 27.67-37.68%		T3 (n=591) 37.69-76.91%		T1 (n=591) 0.00-19.58%		T2 (n=592) 19.59-30.21%		T3 (n=591) 30.22-69.47%		T1 (n=591) 0.12-20.62%		T2 (n=592) 20.68-34.06%		T3 (n=591) 34.13-78.92%	
	Mean	SEM	Mean <sup>b</sup>	SEM	Mean	SEM	Mean	SEM	Mean <sup>2</sup>	SEM	Mean	SEM	Mean	SEM	Mean <sup>2</sup>	SEM	Mean	SEM	Mean	SEM
PANDiet score (0-100)	64.3	0.14	62.6	0.22	64.5**	0.24	66.2**	0.24	63.5	0.24	64.2*	0.24	65.3**	0.24	65.3	0.25	65.0	0.24	62.9**	0.22
AS (0-100)	63.6	0.31	62.2	0.51	64.7*	0.54	64.2*	0.56	61.6	0.53	64.0*	0.54	65.4**	0.54	64.7	0.57	64.1	0.54	62.3*	0.50
Probabilities of adequacy for AS components (0-1)																				
<i>Protein</i>	0.89	0.00	0.89	0.01	0.91	0.01	0.87	0.01	0.86	0.01	0.89*	0.01	0.92**	0.01	0.87	0.01	0.90*	0.01	0.90*	0.01
<i>LA</i>	0.43	0.01	0.46	0.01	0.41*	0.01	0.42*	0.01	0.49	0.01	0.46	0.01	0.34**	0.01	0.34	0.01	0.45**	0.01	0.48**	0.01
<i>ALA</i>	0.11	0.00	0.11	0.01	0.11	0.01	0.11	0.01	0.13	0.01	0.10*	0.01	0.09*	0.01	0.10	0.01	0.12	0.01	0.10	0.01
<i>DHA</i>	0.22	0.01	0.15	0.01	0.25**	0.01	0.28**	0.01	0.22	0.01	0.23	0.01	0.23	0.01	0.25	0.01	0.23	0.01	0.19*	0.01
<i>EPA+DHA</i>	0.20	0.01	0.14	0.01	0.22**	0.01	0.25**	0.01	0.19	0.01	0.20	0.01	0.20	0.01	0.22	0.01	0.21	0.01	0.17*	0.01
<i>Fiber</i>	0.39	0.01	0.37	0.01	0.40	0.01	0.41	0.01	0.35	0.01	0.38*	0.01	0.45**	0.01	0.46	0.01	0.38**	0.01	0.34**	0.01
<i>Vitamin A</i>	0.52	0.01	0.49	0.01	0.56*	0.01	0.51	0.01	0.46	0.01	0.53**	0.01	0.56**	0.01	0.60	0.01	0.51**	0.01	0.47**	0.01
<i>Thiamin</i>	0.96	0.00	0.96	0.00	0.96	0.00	0.97**	0.00	0.96	0.00	0.97*	0.00	0.97*	0.00	0.96	0.00	0.97	0.00	0.96	0.00
<i>Riboflavin</i>	0.76	0.01	0.75	0.01	0.78	0.01	0.75	0.01	0.71	0.01	0.77**	0.01	0.80**	0.01	0.77	0.01	0.77	0.01	0.75	0.01
<i>Niacin</i>	1.00	0.00	1.00	0.00	1.00*	0.00	1.00*	0.00	0.99	0.00	1.00**	0.00	1.00**	0.00	1.00	0.00	1.00*	0.00	1.00	0.00
<i>Pantothenic acid</i>	0.87	0.00	0.85	0.01	0.89**	0.01	0.88*	0.01	0.84	0.01	0.88**	0.01	0.89**	0.01	0.87	0.01	0.88	0.01	0.86	0.01
<i>Vitamin B-6</i>	0.69	0.01	0.64	0.01	0.71**	0.01	0.74**	0.01	0.65	0.01	0.69*	0.01	0.73**	0.01	0.73	0.01	0.71	0.01	0.64**	0.01
<i>Folate</i>	0.66	0.01	0.61	0.01	0.70**	0.01	0.69**	0.01	0.63	0.01	0.66	0.01	0.70**	0.01	0.72	0.01	0.68*	0.01	0.61**	0.01
<i>Vitamin B-12</i>	0.65	0.01	0.62	0.01	0.66*	0.01	0.67*	0.01	0.61	0.01	0.65*	0.01	0.69**	0.01	0.66	0.01	0.66	0.01	0.63	0.01
<i>Vitamin C</i>	0.43	0.01	0.34	0.01	0.44**	0.02	0.52**	0.02	0.43	0.02	0.45	0.02	0.39	0.02	0.49	0.02	0.43*	0.02	0.37**	0.01
<i>Vitamin D</i>	0.03	0.00	0.03	0.00	0.04	0.00	0.04	0.00	0.03	0.00	0.03	0.00	0.03	0.00	0.04	0.00	0.03	0.00	0.03	0.00
<i>Vitamin E</i>	0.80	0.00	0.81	0.01	0.80	0.01	0.79	0.01	0.80	0.01	0.81	0.01	0.79	0.01	0.78	0.01	0.81*	0.01	0.81*	0.01
<i>Iodine</i>	0.72	0.01	0.71	0.01	0.72	0.01	0.74*	0.01	0.69	0.01	0.73*	0.01	0.75**	0.01	0.75	0.01	0.72	0.01	0.70*	0.01
<i>Magnesium</i>	0.48	0.01	0.48	0.01	0.50	0.01	0.48	0.01	0.47	0.01	0.45	0.01	0.53*	0.01	0.48	0.01	0.49	0.01	0.48	0.01
<i>Phosphorus</i>	0.97	0.00	0.96	0.00	0.98**	0.00	0.97**	0.00	0.96	0.00	0.98**	0.00	0.98**	0.00	0.97	0.00	0.98	0.00	0.96**	0.00
<i>Potassium</i>	0.66	0.01	0.64	0.01	0.68*	0.01	0.67*	0.01	0.61	0.01	0.66*	0.01	0.71**	0.01	0.70	0.01	0.67	0.01	0.62**	0.01
<i>Selenium</i>	0.95	0.00	0.93	0.00	0.95*	0.00	0.95*	0.00	0.94	0.00	0.95	0.00	0.95	0.00	0.94	0.00	0.95	0.00	0.94	0.00
<i>Absorbed zinc</i>	0.29	0.01	0.29	0.01	0.30	0.01	0.27	0.01	0.30	0.01	0.28	0.01	0.29	0.01	0.26	0.01	0.27	0.01	0.33**	0.01
<i>Copper</i>	0.91	0.00	0.91	0.01	0.92	0.01	0.89	0.01	0.88	0.01	0.91**	0.01	0.93**	0.01	0.91	0.01	0.91	0.01	0.90	0.01
<i>Manganese</i>	0.90	0.00	0.90	0.01	0.92	0.01	0.89*	0.01	0.87	0.01	0.91**	0.01	0.93**	0.01	0.91	0.01	0.91	0.01	0.89*	0.01
<i>Calcium</i>	0.64	0.01	0.67	0.01	0.64	0.01	0.60*	0.01	0.59	0.01	0.66**	0.01	0.66**	0.01	0.63	0.01	0.64	0.01	0.64	0.01
<i>Absorbed iron</i>	0.61	0.01	0.61	0.01	0.63	0.01	0.59	0.01	0.56	0.01	0.61**	0.01	0.68**	0.01	0.63	0.01	0.61	0.01	0.60*	0.01
MS (0-100)	65.0	0.23	63.0	0.37	64.3*	0.40	68.1**	0.41	65.4	0.39	64.5	0.40	65.2	0.40	66.0	0.42	65.9	0.40	63.5**	0.37
Probabilities of adequacy for MS components (0-1)																				
<i>Protein</i>	0.94	0.00	0.93	0.01	0.94	0.01	0.94	0.01	0.93	0.01	0.95	0.01	0.92	0.01	0.93	0.01	0.95	0.01	0.93	0.01
<i>Carbohydrates</i>	0.94	0.00	0.93	0.00	0.94	0.01	0.95*	0.01	0.94	0.00	0.97**	0.01	0.92**	0.01	0.92	0.01	0.95**	0.01	0.95**	0.00
<i>Total fat</i>	0.92	0.00	0.92	0.01	0.91	0.01	0.92	0.01	0.91	0.01	0.90	0.01	0.94**	0.01	0.93	0.01	0.91*	0.01	0.92	0.01
<i>SFA</i>	0.30	0.01	0.27	0.01	0.27	0.01	0.35**	0.01	0.32	0.01	0.24**	0.01	0.33	0.01	0.35	0.01	0.28**	0.01	0.26**	0.01
<i>Sugars (without lactose)</i>	0.65	0.01	0.61	0.01	0.65	0.01	0.71**	0.01	0.59	0.01	0.66**	0.01	0.71**	0.01	0.69	0.01	0.69	0.01	0.59**	0.01
<i>Sodium</i>	0.18	0.00	0.15	0.01	0.16	0.01	0.24**	0.01	0.26	0.01	0.16**	0.01	0.12**	0.01	0.17	0.01	0.19	0.01	0.19	0.01
PDI (18-90)	52.1	0.14	51.3	0.24	51.9	0.25	53.5**	0.26	52.1	0.25	51.9	0.25	52.4	0.25	53.5	0.26	52.1**	0.25	51.1**	0.23
hPDI (18-90)	52.4	0.16	51.4	0.26	52.4*	0.27	53.4**	0.28	51.2	0.27	52.3*	0.27	53.6**	0.27	54.4	0.28	53.0**	0.27	50.1**	0.25
uPDI (18-90)	55.6	0.18	58.4	0.29	55.1**	0.30	53.0**	0.32	56.3	0.31	55.3*	0.32	55.2*	0.32	53.7	0.32	54.1	0.31	58.4**	0.28

<sup>a</sup> Data from the Individual and National Study on Food Consumption Survey 3, n=1774. Data were collected by three 24h-recalls.

<sup>b</sup> Means adjusted for season of recall and weighted for the survey design. Significantly different from the mean of the first tertile: \*, P<0.05; \*\*, P<0.001; P ≥ 0.05, NS. P for ANOVA tests adjusted for season of recall.

ALA, alpha-linolenic acid; DHA, docosahexaenoic acid; EPA, eicosapentaenoic acid; hPDI, healthy Plant-based Diet Index; LA, linoleic acid; MPF, unprocessed/minimally processed foods; NS, non-significant; PANDiet, Probability of Adequate Nutrient Intake; PF, processed foods; SEM: standard error of the mean; SFA, saturated fatty acids; T, tertile; uPDI, unhealthy Plant-based diet Index, UPF, ultra-processed foods.

**Supplementary Table S7** Predicted number of deaths avoided from cerebrovascular diseases, ischemic heart diseases and diabetes by each nutritional factor weighted in the comparative risk assessment using the EPIDiet model, in the context of a shift of the population's diet from the first tertile to the third tertile of the proportion of unprocessed/minimally processed foods (MPF), processed foods (PF) and ultra-processed foods (UPF) in the diet in the French adult population<sup>a</sup>.

	Proportion of total energy intake from MPF – T3 vs T1			Proportion of total energy intake from PF – T3 vs T1			Proportion of total energy intake from UPF – T3 vs T1		
	Cerebrovascular diseases	Ischemic heart diseases	Diabetes	Cerebrovascular diseases	Ischemic heart diseases	Diabetes	Cerebrovascular diseases	Ischemic heart diseases	Diabetes
Death avoided or added by nutritional factors <sup>b</sup> (number)									
<i>Whole grains</i>	204	125	109	-177	-119	-104	-44	-16	-19
<i>PUFA</i>	38	474	NA	-3	-642	NA	-30	18	NA
<i>Nuts &amp; Seeds</i>	NA	642	249	NA	-662	-245	NA	-19	-30
<i>SFA</i>	-36	-39	NA	-3	101	NA	31	-75	NA
<i>MUFA</i>	-18	-213	NA	-7	25	NA	25	133	NA
<i>Dietary cholesterol</i>	-3	-29	NA	2	-44	NA	8	64	NA
<i>Seafood omega-3 fats</i>	NA	800	NA	NA	-16	NA	NA	-703	NA
<i>Vegetables</i>	1017	419	NA	-226	-89	NA	-1049	-405	NA
<i>Fibers</i>	318	515	NA	-116	-118	NA	-192	-383	NA
<i>Processed meats</i>	NA	1157	364	NA	-14	-13	NA	-2164	-852
<i>Total fat</i>	-37	-113	NA	-6	142	NA	40	-87	NA
<i>Fruits</i>	814	504	NA	-421	-231	NA	-361	-182	NA
<i>Sodium</i>	245	260	NA	-389	-396	NA	179	177	NA
<i>Alcohol</i>	-27	-375	-93	-172	255	91	-285	94	-16
<i>Red meats unprocessed</i>	NA	NA	-124	NA	NA	7	NA	NA	51
<i>SSB</i>	-31	212	NA	-43	201	-22	-34	-527	-153
Death avoided or added because of energy intake and BMI <sup>b</sup> (number)									
<i>Total energy</i>	213	401	223	-193	-348	-209	63	90	57
<i>BMI</i>	180	375	167	-235	-391	-286	29	36	13
Total death avoided <sup>b</sup> (number)	2419 (2216, 2621)	4023 (3744, 4303)	665 (572, 759)	-1911 (-2109, -1713)	-1419 (-2097, -741)	-560 (-931, -188)	-1880 (-2165, -1595)	-5447 (-9439, -1457)	-1066 (-2248, 117)
Percentage deaths avoided <sup>b</sup> (%)	24.9 (22.8, 27.0)	30.9 (28.8, 33.0)	18.5 (15.9, 21.1)	-19.7 (-21.7, -17.6)	-10.9 (-16.1, -5.7)	-15.6 (-25.9, -5.2)	-19.4 (-22.3, -16.4)	-41.8 (-72.5, -11.2)	-29.6 (-62.5, 3.2)

<sup>a</sup> Dietary data from the Individual and National Study on Food Consumption Survey in France (INCA3). Data were collected by three 24h-recalls.

<sup>b</sup> Based on the numbers of disease-specific deaths observed in France in 2014. Negative values correspond to increasing deaths and positive values to decreasing deaths.

MPF, unprocessed/minimally processed foods; MUFA; Monounsaturated fatty acids; NA: Not applicable within the scope of this study; PF, processed foods; PUFA: Polyunsaturated fatty acids; SFA, Saturated fatty acids; SSB, sugar-sweetened beverage; T1: 1<sup>st</sup> tertile; T3: 3<sup>rd</sup> tertile; UPF, ultra-processed foods.

## References

1. Food and Agriculture Organization of the United Nations (2013) Dietary protein quality evaluation in human nutrition: report of an FAO expert consultation, 31 March-2 April, 2011, Auckland, New Zealand. Food and Agriculture Organization of the United Nations, Rome
2. Anses (2016) Actualisation des repères du PNNS : élaboration des références nutritionnelles. French Agency for Food, Environmental and Occupational Health Safety (Anses)., Maisons-Alfort, France
3. Anses (2011) Actualisation des apports nutritionnels conseillés pour les acides gras. French Agency for Food, Environmental and Occupational Health Safety (Anses)., Maisons-Alfort, France
4. EFSA (European Food Safety Agency) (2017) Dietary Reference Values for nutrients: Summary report. 92. <https://doi.org/10.2903/sp.efsa.2017.e15121>
5. EFSA NDA Panel (EFSA Panel on Nutrition, Novel Foods and Food Allergens) (2016) Scientific opinion on Dietary Reference Values for vitamin B6. EFSA Journal
6. de Gavelle E, Huneau J-F, Mariotti F (2018) Patterns of Protein Food Intake Are Associated with Nutrient Adequacy in the General French Adult Population. *Nutrients* 10:226. <https://doi.org/10.3390/nu10020226>
7. Verger EO, Mariotti F, Holmes BA, et al (2012) Evaluation of a Diet Quality Index Based on the Probability of Adequate Nutrient Intake (PANDiet) Using National French and US Dietary Surveys. *PLoS ONE* 7:e42155. <https://doi.org/10.1371/journal.pone.0042155>
8. de Gavelle E, Huneau J-F, Fouillet H, Mariotti F (2019) The Initial Dietary Pattern Should Be Considered when Changing Protein Food Portion Sizes to Increase Nutrient Adequacy in French Adults. *The Journal of Nutrition* 149:488–496. <https://doi.org/10.1093/jn/nxy275>
9. Anses (2019) Anses Opinion on the updating of the PNNS dietary guidelines for women from menopause and men over 65 years of age. French Agency for Food, Environmental and Occupational Health Safety (Anses)., Maisons-Alfort, France
10. Satija A, Bhupathiraju SN, Rimm EB, et al (2016) Plant-Based Dietary Patterns and Incidence of Type 2 Diabetes in US Men and Women: Results from Three Prospective Cohort Studies. *PLoS Med* 13:e1002039. <https://doi.org/10.1371/journal.pmed.1002039>
11. Satija A, Bhupathiraju SN, Spiegelman D, et al (2017) Healthful and Unhealthful Plant-Based Diets and the Risk of Coronary Heart Disease in U.S. Adults. *Journal of the American College of Cardiology* 70:411–422. <https://doi.org/10.1016/j.jacc.2017.05.047>