



HAL
open science

Isolation, identification, and gene expression analysis of the main digestive enzymes during ontogeny of the Neotropical catfish *Pseudoplatystoma punctifer* (Castelnau, 1855)

D. Castro-Ruiz, K.B. Andree, E. Blondeau-Bidet, C. Fernández-Méndez, C.
García-Dávila, E. Gisbert, Maria J. Darias

► To cite this version:

D. Castro-Ruiz, K.B. Andree, E. Blondeau-Bidet, C. Fernández-Méndez, C. García-Dávila, et al.. Isolation, identification, and gene expression analysis of the main digestive enzymes during ontogeny of the Neotropical catfish *Pseudoplatystoma punctifer* (Castelnau, 1855). *Aquaculture*, 2021, 543, pp.737031. 10.1016/j.aquaculture.2021.737031 . hal-03276629

HAL Id: hal-03276629

<https://hal.science/hal-03276629>

Submitted on 16 Nov 2021

HAL is a multi-disciplinary open access archive for the deposit and dissemination of scientific research documents, whether they are published or not. The documents may come from teaching and research institutions in France or abroad, or from public or private research centers.

L'archive ouverte pluridisciplinaire **HAL**, est destinée au dépôt et à la diffusion de documents scientifiques de niveau recherche, publiés ou non, émanant des établissements d'enseignement et de recherche français ou étrangers, des laboratoires publics ou privés.

Article published in:
Aquaculture
Volume 543, 15 October 2021, 737031
<https://doi.org/10.1016/j.aquaculture.2021.737031>

Isolation, identification, and gene expression analysis of the main digestive enzymes during ontogeny of the Neotropical catfish *Pseudoplatystoma punctifer* (Castelnau, 1855)

Diana Castro-Ruiz^{a*}, Karl B. Andree^b, Eva Blondeau-Bidet^c, Christian Fernández-Méndez^d,
Carmen García-Dávila^a, Enric Gisbert^b and Maria J. Darias^{c*}

^a Instituto de Investigaciones de la Amazonía Peruana (IIAP), Dirección de Investigación en Ecosistemas Acuáticos Amazónicos (AQUAREC), Laboratorio de Biología y Genética Molecular (LBGM), Carretera Iquitos-Nauta km. 4.5, Iquitos, Peru

^b Institut de Recerca i Tecnologia Agroalimentaries (IRTA), Centre de Sant Carles de la Ràpita (IRTA-SCR), Aquaculture Program, Crta. Poble Nou km 5.5, 43540 Sant Carles de la Ràpita, Spain

^c MARBEC, Univ Montpellier, CNRS, Ifremer, IRD, Montpellier, France

^d Instituto de Investigaciones de la Amazonía Peruana (IIAP), Dirección de Investigación en Ecosistemas Acuáticos Amazónicos (AQUAREC), Laboratorio de Bromatología, Carretera Iquitos-Nauta km. 4.5, Iquitos, Peru

* Corresponding authors: dcastro@iiap.gob.pe (D.C.-R.); maria.darias@ird.fr (M.J.D.)

1 **Highlights**

- 2 • Ontogeny of the digestive enzyme precursors is synchronized with enzyme activity
- 3 • Digestive machinery reaches its maturity as early as at 10 dpf (11 mm TL)
- 4 • α -amylase gene expression pattern suggests early omnivorous feeding behavior

5

6 **Abstract**

7 The ontogeny of the digestive capacities in fish is species-specific and its knowledge is
8 essential for understanding the nutritional requirements of fish larvae. While the Amazon
9 basin contains the world's highest fish biodiversity, the molecular basis of the early digestive
10 physiology has not yet been reported in any Amazonian fish species. In order to increase
11 basic knowledge on the molecular ontogeny of the digestive system of a commercially
12 important Amazonian fish species, six digestive enzyme genes (*α -amylase*, *phospholipase*
13 *A2*, *lipoprotein lipase*, *trypsin*, *chymotrypsin* and *pepsin*) were isolated and identified, and
14 their expression analyzed from 3 to 24 days post fertilization (dpf) in *Pseudoplatystoma*
15 *punctifer*, a catfish species with high potential for aquaculture diversification. The present
16 results, together with those previously obtained on the development of the digestive enzyme
17 activity, showed that gene expression and enzymatic activities are synchronized and that the
18 enzymatic machinery of *P. punctifer* was completely prepared for the onset of exogenous
19 feeding (4 dpf, 6 mm total length, TL) and had reached its maturity between 10 and 13 dpf
20 (11-14 mm TL). This indicated that the transition from the larval to the juvenile mode of
21 digestion had been completed and they were suitable for weaning under culture conditions.
22 Furthermore, the gene expression analyses suggest that this species displays an omnivorous
23 behavior with a preference towards carnivory during early development. The present study
24 provides the first comprehensive ontogenetic analysis of the digestive function from a
25 molecular point of view of a species of the genus *Pseudoplatystoma*, and contributes to the

26 development of feeding strategies in the context of South American aquaculture
27 diversification.

28

29 **Keywords**

30 Digestive system; ontogeny; enzymatic precursors; catfish; fish larvae; phylogeny

31

32 **1. Introduction**

33 The early life stages of fish constitute a very sensitive phase during which morphogenesis
34 occurs in a very short time period and optimal feeding and nutrition at mouth opening are
35 key for survival and growth (Yúfera and Darias, 2007); however, very little is known about
36 the nutritional requirements of fish larvae (Holt, 2011). Studying the natural diets of
37 developing larvae can be difficult, and indirect approaches under culture conditions, such as
38 the characterization of the ontogeny of the digestive system, have been widely used to better
39 understand their developing digestive capacities, and nutritional requirements and conditions
40 (Gisbert et al., 2008; Lazo et al., 2011; Rønnestad et al., 2013; Zambonino Infante et al.,
41 2008; Zambonino Infante and Cahu, 2001). The development of the digestive system is
42 species-specific and is a genetically programmed process that is affected by the general life
43 history and reproductive strategy of each species, and by a variety of abiotic and biotic
44 factors, such as water temperature and food availability and composition (Lazo et al., 2011;
45 Rønnestad et al., 2013; Zambonino Infante et al., 2008). In the context of aquaculture,
46 knowledge of the interspecific differences in the relative timing of the differentiation,
47 development, and functionality of the digestive tract and accessory glands during early life
48 stages is essential to develop feeding protocols adapted to the physiological stages of
49 development of each species. The most common approach to estimate the digestive capacities
50 of fish has been the determination of the activity of digestive enzymes by biochemical
51 analysis. Studies evaluating larval digestive performance are generally focused on the

52 appearance of the activity of pancreatic enzymes before the onset of exogenous feeding, the
53 enzymatic maturation of the brush border of enterocytes, and the appearance of pepsin
54 activity in gastric fish, which mark the transition from the larval to the juvenile mode of
55 digestion (Lazo et al., 2011; Rønnestad et al., 2013; Yúfera et al., 2018; Zambonino Infante
56 et al., 2008). Among the different enzymes involved in digestion, α -amylase (EC 3.2.1.1) is
57 synthesized in the exocrine pancreas and is key for the digestion of complex carbohydrates
58 in fish (Cahu and Zambonino Infante, 1994; Darias et al., 2006; Ma et al., 2005; Moyano et
59 al., 1996). The phospholipases A2 (PLA2, EC 3.1.1.4) are essential lipolytic enzymes that
60 hydrolyze phospholipids to generate free fatty acids and lysophospholipids (Dennis, 1994).
61 The pancreatic phospholipase A2-IB (PLA2-IB) is one of the different types of secretory
62 PLA2 (sPLA2) and it is considered the most important digestive enzyme in marine fish (Cahu
63 et al., 2003; Rønnestad et al., 2013). The pancreatic enzyme trypsin (EC 3.4.21.4) is
64 considered the most important alkaline proteolytic enzyme in early life stages of fish and it
65 also plays a key role in activating other pancreatic enzymes in the gut lumen (Rønnestad et
66 al., 2013). Chymotrypsin (EC 3.4.21.1) is another important pancreatic proteolytic enzyme,
67 whose activity is complementary to that of trypsin. During the digestive system ontogeny of
68 gastric fish, trypsin, and chymotrypsin are responsible of protein digestion in the alkaline
69 environment of the intestine until the stomach is formed. At that time, a third proteolytic
70 enzyme, pepsin, appears. Among the two main classes identified, pepsin A and C, the first
71 one is the predominant form, and several isoforms exist in gastric fish (Kapoor et al., 1976).
72 They are responsible for the initial and partial hydrolysis of proteins in the stomach in the
73 presence of an acidic environment. Its precursor, *pepsinogen*, is produced and secreted by
74 the gastric glands of the stomach, where it is activated by hydrochloric acid (Darias et al.,
75 2005; Darias et al., 2007a; Douglas et al., 1999; Gawlicka et al., 2001). Lipoprotein lipase
76 (LPL, EC 3.1.1.34) is a key regulator of lipid metabolism that hydrolyzes triglyceride-rich
77 lipoproteins transported in the bloodstream as chylomicrons and very-low-density

78 lipoproteins, and the released fatty acids are taken up by the tissues for oxidation or storage
79 (Mead et al., 2002). Contrary to the activity of the main digestive enzymes, the ontogenetic
80 expression pattern of the genes encoding for these enzymes has been studied in relatively few
81 fish species, even though basic knowledge on the molecular mechanisms underlying the
82 function and modulation of the enzymatic hydrolysis of the various dietary macronutrients is
83 necessary to better understand the process of digestion in fish (Yúfera et al., 2018).

84 Covering more than 6 000 000 km², the Amazon basin is home to the richest fish fauna in the
85 world with 2,406 valid species, 1,402 of which are endemic (Jézéquel et al., 2020); however,
86 to our knowledge, no data has been reported on the molecular basis of the early digestive
87 physiology of any Amazonian fish species. Fish is the main source of proteins, essential fatty
88 acids, and micronutrients for the local population, especially for low-income families, and
89 per capita fish consumption is one of the highest in the world (Isaac and de Almeida, 2011).

90 Fish populations are increasingly faced with numerous threats such as pollution,
91 deforestation, hydropower dams, invasive species, and overfishing (Carolsfeld et al., 2003;
92 Winemiller et al., 2016). To counter-balance these effects, aquaculture has been developing
93 steadily for the last decades to contribute to the food needs of a fast growing population
94 (FAO, 2020). Among the cultured species, the highly prized species of the genus
95 *Pseudoplatystoma* Bleeker, 1862 (maximum total lengths of up to 140 cm (Buitrago–Suárez
96 and Burr, 2007)) are the most produced catfish species in South America, and Brazil is the
97 largest producer (IBGE, 2020; Valladão et al., 2018). Production mostly relies on
98 interspecific hybrids (e.g., *P. reticulatum* x *P. corruscans*) for their better growth
99 performance, and more recently, on intergeneric hybrids between *Pseudoplatystoma* spp. and
100 omnivorous catfish species such as *Leiarius marmoratus* or *Phractocephalus hemioliopus*,
101 since they are less cannibalistic during early life stages, readily accept compound diets, and
102 exhibit faster growth rates than the *Pseudoplatystoma* spp. parent species (Hashimoto et al.,
103 2012). However, the production of hybrids entails risks for the environment and the

104 aquaculture industry. Hybrids have been frequently detected in natural environments and, in
105 the case of the interspecific hybrids, are contaminating natural stocks due to their fertility
106 (Hashimoto et al., 2013). Additionally, some genetic monitoring studies have revealed that
107 the production, trade, and management of these hybrids are currently uncontrolled in Brazil,
108 as broodstocks are often mistakenly composed of interspecific hybrids and even post-F1
109 hybrids, causing economic losses (Hashimoto et al., 2015). In this context, in order to achieve
110 sustainability in *Pseudoplatystoma* spp. aquaculture, genetic improvement programs and
111 culture techniques should be developed for pure species seeking to obtain similar
112 performances as those of hybrids (Alves et al., 2014).

113 In order to increase basic knowledge on the molecular basis of the ontogeny of the digestive
114 system of commercially important Amazonian fish species, the aim of this study was to
115 understand the molecular phylogeny of the main digestive enzyme precursors and to analyze
116 their ontogenetic expression pattern in *Pseudoplatystoma punctifer* (Castelnau, 1855). This
117 is a carnivorous migratory catfish species widely distributed in the Amazon basin in Bolivia,
118 Brazil, Colombia, Ecuador, Peru, and Venezuela (Buitrago–Suárez and Burr, 2007) with high
119 potential for aquaculture diversification in the region. We previously analyzed the
120 histological development of the digestive system (Gisbert et al., 2014) and the ontogeny of
121 the digestive enzyme activity (Castro-Ruiz et al., 2019) of this species and in this study we
122 focused on the molecular ontogeny. For that purpose, the digestive enzyme precursors of α -
123 *amylase* (*amy*), *phospholipase A2* (*sPLA2-IB*), *lipoprotein lipase* (*lpl*), *trypsinogen* (*try*),
124 *chymotrypsinogen* (*ctr*), and *pepsinogen* (*pga*) of this species were isolated, partially
125 sequenced, and identified, with gene expression patterns characterized from 3 to 24 days
126 post-fertilization (dpf).

127

128 **2. Materials and Methods**

129 *2.1 Fish rearing and feeding protocol*

130 *Pseudoplatystoma punctifer* larvae were obtained by hormonal-induced spawning of a
131 sexually mature couple of genitors (♀: 4.73 kg; ♂: 1.15 kg) maintained in captivity at the
132 Instituto de Investigaciones de la Amazonia Peruana (IIAP, Iquitos, Peru). The female and
133 male were injected intramuscularly with the synthetic hormone Conceptal® (Intervet,
134 Huixquilucan, México) at 2.6 ml kg⁻¹ and 1 ml kg⁻¹ BW, respectively. Hormone injections
135 were administered in two doses: a first one at 10% and 50% of the total dose, and a second
136 one 12 h later at 90% and 50% of the total dose for female and male, respectively. After
137 ovulation, the female was stripped and the obtained eggs (400 g, *ca.* 800000 eggs) were
138 distributed in batches of 100 g and gently mixed with 5 ml of physiological serum and 300
139 µl of previously collected sperm for 1 min. Then, 30 ml of distilled water was added with
140 constant gentle stirring for another 1 min. Fertilized eggs were rinsed three times with 100
141 ml of water from the incubators and transferred thereafter to 60 L cylindroconical incubators
142 connected to a recirculation water system at 28 °C. The larvae hatched 18 ± 2 h later (hatching
143 rate = 84%) and were transferred at 3 dpf to three 30 L fiberglass tanks connected to a water
144 recirculation system provided with mechanical and biological filters. The rearing conditions
145 were as follows: temperature, 28.3 ± 0.4 °C; pH, 6.9 ± 0.2; dissolved oxygen, 8.2 ± 0.5 mg
146 l⁻¹; NO₂⁻, 0.04 ± 0.02 mg l⁻¹, NH₄⁺, 0.14 ± 0.05 mg l⁻¹, and water flow rate of 0.2 l min⁻¹.
147 The larvae were reared in triplicate (initial density 90 larvae l⁻¹) under a photoperiod of 0L:
148 24D and fed six times a day from 4 to 17 dpf with non-enriched *Artemia* spp. nauplii (37%
149 proteins, 14% lipids, and 11% carbohydrates) in slight excess (0.4 to 17 nauplii ml⁻¹)
150 considering the larval density, the weight increase of the larvae, and the daily food ration and
151 weaned onto a commercial inert diet (BioMar®, Nersac, France; proximate composition: 58%
152 proteins, 15% lipids, 20% carbohydrates, 11% ash; particle size: 0.5 mm) within 4 days. Once
153 weaned, individuals were fed five times a day at 5% of the larval wet weight until the end of
154 the experiment at 24 dpf.

155 In the absence of an *ad hoc* ethical committee at the IIAP where this trial was conducted, the
156 animal experimental procedures were conducted in compliance with the Guidelines of the
157 European Union Council (2010/63/EU) on the protection of animals used for scientific
158 purposes.

159

160 *2.2 Sampling and growth measurements*

161 Whole larvae and early juveniles were collected at 3, 10, 13, 18, and 24 dpf and euthanized
162 with an overdose of Eugenol (0.05 $\mu\text{l ml}^{-1}$; Moyco[®], Moyco, Lima, Peru). The sampling
163 criterion was based both on the developmental stage and the feeding protocol used (Figure
164 1). Sampling was done in the morning before the first feeding of the day. For total length
165 (TL) measurements, 15-30 individuals, depending on the size, were placed in a Petri dish,
166 photographed using a scale bar and TL was measured on the pictures using ImageJ software
167 (Schneider et al., 2012). For evaluating the expression of the digestive enzyme genes
168 throughout development, 100 mg of pooled individuals (125 to 6 individuals, depending on
169 size) at each sampling point were preserved in RNAlater (1:10 dilution) at -20 °C until further
170 analyses. Survival was evaluated by counting the individuals surviving at the end of each
171 feeding period and considering the number of sampled individuals.

172

173 *2.3 Partial mRNA isolation, identification and phylogenetic analysis*

174 Total RNA was extracted using TRIzol[™] (Invitrogen, San Diego, CA, USA) according to
175 manufacturer's protocol. RNA concentration and quality were determined by
176 spectrophotometry (NanoDrop2000, Thermo Fisher Scientific, Madrid, Spain) measuring the
177 absorbance at 260 and 280 nm and a denaturing electrophoresis in TAE agarose gel (1.5 %).
178 For the preparation of cDNA, total RNA was treated with DNase I Amplification Grade
179 (Invitrogen) according to manufacturer's protocol to remove genomic DNA traces. Total
180 RNA was then reverse transcribed in 10 μl reaction volume containing 3 μg total RNA using

181 the SuperScript™ First-Strand Synthesis System for RT-PCR (Invitrogen) with oligo (dT)
182 (12-18) (0.5 µg/ul) and random hexamers primers (50 ng µl⁻¹), 10X RT buffer (200mM Tris-
183 HCl (pH 8.4), 500 mM KCL) 25 mM MgCl₂, 0.1 M DTT, 10 mM dNTP mix, SuperScript™
184 II RT (50 U µl⁻¹), RNaseOUT™ (40 U µl⁻¹) followed by RNase H (2 U µl⁻¹) (Invitrogen)
185 treatment. Reverse transcription reactions were carried out in a thermocycler (Mastercycle R
186 nexus GSX1, Eppendorf AG, Hamburg, Germany) and run according to manufacturer's
187 protocol. Samples were diluted 1:20 in molecular biology grade water and stored at -20 °C
188 until further analyses. To obtain the specific sequences of *try*, *ctr*, *amy*, *lpl*, *sPLA2-IB*, *pga*,
189 and Gliceraldehyde-3-fosphate deshydrogenase (*gadph*) genes, alignments of teleost
190 homologs for these genes' sequences obtained from GenBank were made using BioEdit
191 Sequence Alignment Editor ver. 7.0.5.2 (Hall, 1999). Consensus primers designed from
192 conserved regions identified in these alignments were used for amplification of *P. punctifer*
193 specific gene sequences. The fragments amplified were separated in 2% agarose gel
194 electrophoresis and resulting bands of the expected size were excised, isolated, purified
195 (QIAQuick PCR purification kit, Qiagen, Hilden, Germany) and sequenced. The identity of
196 each sequence was verified using the NCBI Blast analysis tool
197 (www.ncbi.nlm.nih.gov/BLAST) and sequences were deposited in Genbank (Table 1).
198 For the phylogenetic analyses, protein sequences from different species coding for each gene
199 were obtained at NCBI (Tables A1-6). Multiple protein alignments were performed with
200 MAFFT (Kato et al., 2002) and ambiguous regions were removed with Gblocks V0.91b
201 (Talavera and Castresana, 2007). The phylogenetic trees were inferred using the maximum
202 likelihood (ML) method implemented in the PhyML program (v3.1/3.0 aLRT) (Guindon and
203 Gascuel, 2003). Best model of evolution was selected using Modelgenerator V.85 (Keane et
204 al., 2006) following the corrected Akaike Information Criterion (with four discrete gamma
205 categories) and used to construct a phylogenetic tree. Bayesian posterior probabilities were
206 computed with MrBayes 3.2.1 (Ronquist and Huelsenbeck, 2003). Two different runs with

207 four incrementally heated simultaneous Monte Carlo Markov chains were conducted over
208 one million generations. Trees were sampled every 100 generations to produce 10,000 trees.
209 In order to estimate posterior probabilities, 25% of the trees were discarded as a burn-in stage,
210 observing when average standard deviation of split frequency (ASDSF) values dropped
211 below 0.01. Trees were generated using MEGA 10.1.7 software and robustness of the
212 phylogeny assumption was evaluated by the bootstrapping procedure from 1000 data-set
213 replicates and with posterior probabilities (PP). The nodes supported at or above the 50%
214 level in the bootstrap analysis were emphasized.

215

216 *2.4 Gene expression analyses of digestive enzymes during development*

217 The transcript sequences were used as templates to design specific primers with the primer 3
218 software (Table 1). Quantitative PCR analyses for each gene were performed in triplicate in
219 a 7300 Real-Time PCR System (Applied Biosystems, Roche, Barcelona, Spain). The
220 amplification mix contained 1 µl cDNA, 0.5 µl primers (20 µM) and 10 µl SYBR Green
221 Supermix (Life Technologies, Carlsbad, CA, USA) in a total volume of 20 µl. A negative
222 control was included for each set of reactions on each 96-well plate. The amplification
223 conditions were: 10 min at 95 °C, 40 cycles of 20 s at 95 °C and 1 min at 65 °C, followed by
224 15 s at 95 °C, 1 min at 60 °C, 15 s at 95 °C, and finally 15 s at 60 °C. A standard curve was
225 obtained by amplification of a dilution series of cDNA to calculate the amplification
226 efficiency (E) for each set of primers. Real-time PCR efficiencies were determined for each
227 gene from the slopes obtained with Applied Biosystems software, applying the equation
228 $E=10[-1/\text{slope}]$, where E is PCR efficiency. The relative gene expression ratio (R) for each
229 gene was calculated according to Pfaffl's (2001) formula: $R = (E_{\text{target gene}})^{\Delta Cq_{\text{target gene (mean sample}}}$
230 $- \text{mean reference sample}) / (E_{\text{reference gene}})^{\Delta Cq_{\text{reference gene (mean sample - mean reference sample)}}$, where ΔCq is the
231 deviation of the target sample minus the reference sample. The initial time point (3 dpf) was
232 chosen as the reference sample and the relative gene expression was normalized using *gadph*

233 as the reference gene since it did not exhibit any significant variation in expression between
234 the samples.

235

236 *2.5 Statistics*

237 Results of gene expression were expressed as mean \pm SD (n=9). All data were checked for
238 normality (Kolmogorov–Smirnov test) and homogeneity of variance (Bartlett's test). One-
239 Way ANOVA was performed to analyze differences in gene expression during development.
240 All Pairwise Multiple Comparisons were performed using the Holm-Sidak method when
241 significant differences were found at $P < 0.05$. Statistical analyses were conducted using
242 SigmaStat 3.0 (Systat Software Inc., Richmond, VA, USA).

243

244 **3. Results**

245 *3.1 Growth and survival*

246 Growth during the ontogeny of *P. punctifer* followed an exponential curve $TL \text{ (mm)} = 4.181$
247 $e^{0.23 \times T}$ ($r^2 = 0.97$, $P < 0.05$) (Figure 1). Survival rate was 95 % and 49% at the end of the
248 *Artemia* feeding period (17 dpf) and at the end of the experiment (24 dpf), respectively.

249

250 *3.2 Sequences and phylogenetic analyses*

251 The size of the partial nucleotide sequences isolated for *P. punctifer* is indicated in Table 1.
252 Since the aim of this work was to analyze the expression patterns of these genes during
253 ontogeny, obtaining the full-length cDNAs was not pursued.

254

255 *3.2.1 Alpha amylase*

256 Phylogenetic analysis of 14 teleost α -amylase protein sequences revealed a broad congruence
257 among the results of the Maximum Likelihood (ML) and Bayesian analyses (Figure 2). Seven
258 nodes received strong support in each (ML bootstrap supports between 67 and 100%,

259 Bayesian posterior probabilities of 1.0), whereas 6 nodes received no support (ML bootstrap
260 between 28 and 41%, Bayesian posterior probabilities between 0.6 and 0.8). The
261 phylogenetic analysis revealed two main clades. The first one was composed of two clusters,
262 one containing 4 species from the order Siluriformes (*Tachysurus fulvidraco*, *Bagarius*
263 *yarelli*, *P. punctifer*, *Pangasianodon hypophthalmus*) and the other including two species
264 from the order Cypriniformes (*Ctenopharyngodon idella*, *Labeo rohita*). The second clade
265 was also divided in two other clusters. The first one was represented by Salmoniformes
266 (*Salmo salar*) and the second one included different orders of Eupercaria represented by
267 Tetraodontiformes (*Tetraodon nigroviridis*), Caragiformes (*Seriola lalandi dorsalis*),
268 Perciformes (*Epinephelus coioides*, *Siniperca chuatsi*), Spariformes (*Sparus aurata*, *Pagrus*
269 *pagrus*), and Pleuronectiformes (*Pseudopleuronectes americanus*). *Pseudoplatystoma*
270 *punctifer* was grouped within the catfish (Siluriformes) clade (Bayesian = 1), where the
271 analyzed sequences displayed the highest percentage of identity with *P. punctifer* that ranged
272 between 85 and 87% (Table A1). The following groups with higher identity percentage with
273 *P. punctifer* were species from the order Spariformes, Perciformes, Carangiformes and
274 Pleuronectiformes (78-77%), and the lowest percentage of identity corresponded to species
275 from the orders Cypriniformes, Perciformes and Tetraodontiformes (76%).

276

277 3.2.2 Phospholipase A2

278 Phylogenetic analysis of 18 teleost phospholipase A2 protein sequences revealed a broad
279 consistency among the results of the ML bootstrap and Bayesian posterior analyses (Figure
280 3). Four nodes received strong support in each (ML bootstrap supports between 85 and 96%,
281 Bayesian posterior probabilities of 0.9-1.0), 4 nodes received medium support for ML
282 bootstrap (50-70%) but high support by Bayesian posterior probabilities (0.92-0.99) and 6
283 nodes received no support (ML bootstrap support between 28 and 55%, Bayesian posterior
284 probabilities between 0.6 and 0.9). The phylogenetic analysis revealed two main clades.

285 The first one was represented by *Oncorhynchus mykiss* (Salmoniformes) and the second one
286 was composed of two clusters. One of them contained species from the orders Gobiiformes
287 (*Parambassis ranga*), Cichliformes (*Oreochromis niloticus*, *Neolamprologus brichardi*), and
288 Carangiformes (*Seriola dumerili*), and the other one was divided into two more clusters. The
289 first cluster was represented by a species from the order Osteoglossiformes (*Scleropages*
290 *formosus*) and the second included two clades: one was composed of species from the orders
291 Siluriformes (*Ictalurus punctatus*, *P. hypophthalmus*, *P. punctifer*, *T. fulvidraco*),
292 Gymnotiformes (*Electrophorus electricus*), and Characiformes (*Astyanax mexicanus*,
293 *Colossoma macropomum*); and the other was composed of species belonging to the orders
294 Cyprinodontiformes (*Kryptolebias marmoratus*, *Xiphophorus couchianus*), Beloniformes
295 (*Oryzias melastigma*, *O. latipes*), and Esociformes (*Esox lucius*). The node of the clade
296 Siluriformes was supported by the Bayesian posterior analysis but not by the ML bootstrap,
297 and the only supported classification within the clade was that grouping *P. punctifer* and *T.*
298 *fulvidraco* (Figure 3). The phospholipase A2 of *P. punctifer* presented the highest percentage
299 of identity with the sequences of the Siluriformes species (97%, Table A2). The following
300 groups with higher identity percentage with *P. punctifer* corresponded to species from the
301 order Characiformes and Gymnotiformes (89-92%), and the lowest percentage of identity
302 corresponded to the species from the orders Cyprinodontiformes, Beloniformes, and
303 Osteoglossiformes (66-69%, Table A2).

304

305 3.2.3 Lipoprotein lipase

306 Phylogenetic analysis of 19 teleost lipoprotein lipase protein sequences revealed a very broad
307 congruence among the results of the ML bootstrap and Bayesian posterior analyses (Figure
308 4). Fourteen nodes received strong support in each (ML bootstrap supports between 77 and
309 100%, Bayesian posterior probabilities of 0.93-1.0), one node received medium support for
310 ML bootstrap (59%) but good support by Bayesian posterior probabilities (0.93) and two

311 nodes received support by bootstrap (60 and 64%) but not by Bayesian analysis (0.6 and 0.8).
312 The phylogenetic analysis revealed two main clades. The first clade was composed of two
313 clusters. The first one included species from the order Salmoniformes (*Oncorhynchus*
314 *clarkia*, *O. mykiss*) and second one was represented by species from the orders Moroniformes
315 (*Dicentrarchus labrax*), Pleuronectiformes (*Scophthalmus maximus*, *Paralichthys*
316 *olivaceus*), Perciformes (*S. chuatsi*), and Spariformes (*Pagrus major*, *S. aurata*). The second
317 clade was also divided into two clusters. One grouped species from the orders Characiformes
318 (*A. mexicanus*), Gymnotiformes (*E. electricus*), and Siluriformes (*I. punctatus*, *P.*
319 *hypophthalmus*, *P. punctifer*, *T. fulvidraco*), and the other was represented by several species
320 of the order Cypriniformes (*C. idella*, *Danio rerio*, *Carassius auratus*, *Cyprinus carpio*). The
321 node of the clade Siluriformes was supported by both the ML and the Bayesian posterior
322 analyses (Figure 4). The lipoprotein lipase sequence of *P. punctifer* showed the highest
323 percentage of identity with the sequences of omnivorous species of the order Cypriniformes
324 (91-89%), followed by species from the orders Salmoniformes, Characiformes, Siluriformes,
325 and Cypriniformes (88%). The lowest percentage of identity corresponded to species from
326 the orders Pleuronectiformes, Moroniformes, and Spariformes (82-79%, Table A3).

327

328 3.2.4 Trypsin

329 Phylogenetic analysis of 16 teleost trypsin protein sequences revealed three main clusters
330 that were fully supported by the ML (100%) and Bayesian posterior analyses (1.0) (Figure
331 5). A first cluster was composed of species represented by the orders Pleuronectiformes (*P.*
332 *americanus*), Tetraodontiformes (*Takifugu flavidus*), Perciformes (*Gymnodraco acuticeps*),
333 Salmoniformes (*Oncorhynchus nerka*, *Salmo trutta*), Esociformes (*E. lucius*), Gobiiformes
334 (*P. ranga*), and Spariformes (*S. aurata*, *P. pagrus*). The only supported node of this clade
335 was that grouping the Salmoniformes species (ML 65%, Bayesian 0.97) and the Spariformes
336 species (ML 79%, Bayesian 0.99) together. A second cluster was represented by the orders

337 Cypriniformes (*C. carpio*) and Clupeiformes (*Denticeps clupeioides*), and a third cluster
338 grouped species from the order Siluriformes (*Clarias magur*, *I. punctatus*, *P. hypophthalmus*,
339 *P. punctifer*, and *T. fulvidraco*). Regarding the latter, two clades were observed, one
340 represented by *T. fulvidraco*, and the other composed by *C. magur* and another group of
341 species including *I. punctatus*, *P. hypophthalmus*, and *P. punctifer*. The only supported nodes
342 were those that grouped the last three species together (ML 59%, Bayesian 0.94; ML 33%,
343 Bayesian 0.92). The sequence of *P. punctifer* showed the highest percentage of identity with
344 that of the species of the order Siluriformes (86-82%) and also with *D. clupeioides* (84%).
345 The lowest percentage of identity corresponded to species from the orders Pleuronectiformes
346 and Spariformes (73%, Table A4).

347

348 3.2.5 Chymotrypsin

349 The phylogenetic tree of 14 teleost chymotrypsin protein sequences is shown in Figure 6.
350 The ML and Bayesian posterior analyses revealed 7 nodes that received strong support in
351 each (ML 69-99%, Bayesian 1.0), one node only supported by the Bayesian posterior
352 probabilities (0.97) and 5 nodes that were not supported (28-48%, 0.5-0.8). The phylogenetic
353 analysis revealed two first clades that were fully supported. One of them was represented by
354 the order Clupeiformes (*D. clupeioides*), whose sequences corresponded to the isoform B, and
355 the other one grouped the isoform A of the sequences and was divided in two clusters. The
356 first one included species from the order of Siluriformes (*P. hypophthalmus*, *P. punctifer*)
357 and the second one contained two more clusters: one included species from the order
358 Cypriniformes (*D. rerio*, *C. auratus*, *L. rohita*) and the other was represented by species from
359 the order Carangiformes (*S. lalandi dorsalis*), Perciformes (*Perca flavescens*, *Lutjanus*
360 *guttatus*), Scombriformes (*Thunus orientalis*), and Clupeiformes (*Clupea harengus*). The
361 node of the clade Siluriformes that grouped together *P. punctifer* and *P. hypophthalmus* was
362 not supported (ML 47%, B 0.6) and their sequences displayed an 81% identity (Table A5).

363 Similar percentage of identity as with the Siluriformes species was observed for species from
364 the order Cypriniformes, Perciformes and Clupeiformes (81%), and the lowest percentage
365 of identity corresponded to species from the order Cypriniformes and Carangiformes (74-
366 76%, Table A5).

367

368 3.2.6 Pepsin

369 Phylogenetic analysis of 22 teleost pepsinogen protein sequences revealed a broad
370 congruence among the results of the ML bootstrap and Bayesian posterior analyses (Figure
371 7). Twelve nodes received strong support by both analyses (ML 73-100%, Bayesian 0.94-
372 1.0), 3 nodes received medium or low support by ML (39-64%) but high support by Bayesian
373 posterior analysis (0.94-0.99), and 6 nodes were not supported (ML 31-40%, Bayesian 0.58-
374 0.86). The phylogenetic tree of pepsinogen revealed two first clusters. The first one was
375 represented by one species from the order Osteoglossiformes (*S. formosus*) and the second
376 was divided in two main clades. The first clade grouped together species from the order
377 Spariformes (*P. pagrus*, *S. aurata*), Cichliformes (*Cichlasoma trimaculatum*, *O. niloticus*),
378 Pleuronectiformes (*P. olivaceus*, *P. americanus*, *Solea senegalensis*), and Scombriformes (*T.*
379 *orientalis*). The second clade was divided into two clusters, one of them was represented by
380 species from the orders Siluriformes (*P. hypophthalmus*, *T. fulvidraco*, *Bagarius yarrelli*, *P.*
381 *punctifer*) and Gymnotiformes (*E. electricus*), and the other one grouped together species
382 from the orders Perciformes (*S. chuatsi*, *Siniperca scherzeri*, *Micropterus salmoides*),
383 Pleuronectiformes (*P. americanus*), Scombriformes (*T. orientalis*), Gadiformes (*Gadus*
384 *macrocephalus*), Esociformes (*E. lucius*), and Clupeiformes (*D. clupeoides*). According to
385 the phylogenetic tree, the sequences of the species from the order of Siluriformes, including
386 *P. punctifer*, corresponded to pepsinogen A1. The node of the clade Siluriformes was highly
387 supported and grouped *P. punctifer* and *B. yarrelli* together (ML 89%, Bayesian 0.98). They
388 displayed the highest identity percentage (100%) of all sequences analyzed, followed by *T.*

389 *fulvidraco* and *P. hypophthalmus* (93%), and then by *E. electricus*, in accordance with the
390 tree classification. The following groups with higher identity percentage with *P. punctifer*
391 were the species from the order Clupeiformes and Perciformes (75%) and the lowest
392 percentage of identity corresponded to the species from the order Osteoglossiformes (65%)
393 and Chichliformes (64%) (Table A6).

394

395 3.3 Gene expression analyses of digestive enzymes during early stages of development

396 The expression profile of the analyzed digestive genes during the early development of *P.*
397 *punctifer* is shown in Figure 8. The expression of all genes was detected from 3 dpf (6 mm
398 TL at 28 °C). The level of *amy* expression increased 8-fold from 3 dpf (0.17 ± 0.004 relative
399 expression units, reu) to 10 dpf (11 mm TL at 28 °C) (1.4 ± 0.39 reu, $P < 0.05$), then decreased
400 at 13 dpf (14 mm TL at 28 °C) (1.07 ± 0.133 reu, $P < 0.05$) and remained constant until 18
401 dpf (18 mm TL at 28 °C) (1.10 ± 0.003 reu, $P > 0.05$) to increase again 3-fold at 24 dpf (26
402 mm TL at 28 °C) (2.76 ± 0.05 reu, $P < 0.05$). *Try* expression increased from 3 dpf ($3.15 \pm$
403 0.22 reu) to 10 dpf (5.12 ± 0.43 reu, $P < 0.05$), then decreased 2.5-fold at 13 dpf (2.05 ± 0.07
404 reu, $P < 0.05$) and progressively increased until the end of the trial (6.65 ± 0.53 reu; $P <$
405 0.05). *Ctr* expression increased 6-fold from 3 dpf (0.14 ± 0.02 reu) to 10 dpf (0.88 ± 0.14 reu,
406 $P < 0.05$) to abruptly decrease at 13 dpf (0.24 ± 0.04 reu, $P < 0.05$). *Ctr* expression continued
407 to decrease until 18 dpf (0.04 ± 0.0003 reu, $P < 0.05$) to remain constant thereafter ($0.02 \pm$
408 0.005 reu, $P > 0.05$). The level of *pga* expression significantly increased from 10 dpf ($0.71 \pm$
409 0.11 reu) to 13 dpf (237.23 ± 59.06 reu, $P < 0.05$) and continued to increase in an exponential
410 manner until the end the trial (1496.7 ± 619.9 reu, $P < 0.05$). The *sPLA2-IB* expression
411 significantly increased from 3 dpf (0.23 ± 0.02 reu) to 10 dpf (0.94 ± 0.15 reu, $P < 0.05$), and
412 progressively decreased until 18 dpf (0.55 ± 0.24 reu, $P < 0.05$) to remain invariable until the
413 end of the study (0.84 ± 0.08 reu, $P > 0.05$). The level of *lpl* expression significantly increased
414 from 3 dpf (0.03 ± 0.01 reu) to 10 dpf (0.15 ± 0.004 reu, $P < 0.05$), remained constant until

415 13 dpf (0.17 ± 0.05 reu, $P > 0.05$), and increased again from 13 to 18 dpf (0.33 ± 0.12 reu, P
416 < 0.05) to remain constant until the end of the study (0.37 ± 0.23 reu, $P > 0.05$).

417

418 **4. Discussion**

419 This study provides the first comprehensive analysis of the transcriptional ontogeny of some
420 of the most important digestive enzymes of an Amazonian fish species of the genus
421 *Pseudoplatystoma* and gives insights into the molecular phylogeny of the digestive enzymes
422 and the development of the digestive capacities and feeding preferences during the early life
423 stage of *P. punctifer*.

424 Overall, the phylogenetic relationships of the protein sequences of the studied digestive genes
425 of *P. punctifer* corresponded to the phylogenetic classification of bony fishes (Betancur-R et
426 al., 2017). As expected, the protein sequences of *P. punctifer* were clustered together with
427 those of other catfish species in all the phylogenetic trees, and were mostly grouped with the
428 protein sequences of species belonging to the primarily freshwater clade of the Otophysi
429 (Siluriformes, Cypriniformes, Characiformes, and Gymnotiformes) (Betancur-R et al., 2017;
430 Nelson et al., 2016), except in those trees with a higher number of less supported nodes (*try*,
431 *ctr*). Similarly, the protein sequences of the species contained in the Superorder
432 Acanthopterygii (Beloniformes, Carangiformes, Cichliformes, Cyprinodontiformes,
433 Gobiiformes, Moroniformes, Perciformes, Pleuronectiformes, Scombriformes, Spariformes,
434 Tetraodontiformes (Betancur-R et al., 2017; Nelson et al., 2016)) were grouped together in
435 most trees. In addition, most of the studied protein sequences of *P. punctifer* (*amy*, *plA2*, *try*,
436 and *pga*) also showed maximum homology with those of other catfish species, with the
437 exception of *lpl* and *ctr*, probably due to the use of partial sequences and/or problems in the
438 annotation of the isoforms. Nevertheless, the phylogenetic relationships allowed identifying
439 some isoforms of the protein sequences. The *ctr* and *pga* sequences isolated from *P. punctifer*
440 were located in clades with sequences of the isoforms *ctrA* and *pgaA1*, respectively. In

441 contrast, it was difficult to identify the isoform of *try* as the sequences of the other catfish
442 species were all predicted coding sequences.

443 The expression of the different genes analyzed in *P. punctifer* was detected before the onset
444 of exogenous feeding, denoting that it is a genetically programmed process. Similar results
445 have been found in other reared fish species (Cahu et al., 2004; Darias et al., 2006; Darias et
446 al., 2007a, 2007b; Galaviz et al., 2015; Mata-Sotres et al., 2016; Péres et al., 1998;
447 Zambonino Infante et al., 2008).

448 In fish, the stomach is one of the last digestive organs to develop during ontogeny. The onset
449 of the acidic digestion shows the switch from the larval to the juvenile mode of digestion,
450 characterized by a notable improvement of the digestion of complex proteins. This moment
451 is usually considered the transition from the larval to the juvenile stage from a digestive
452 physiology perspective and a suitable moment for weaning onto compound feeds under
453 culture conditions (Lazo et al., 2011; Rønnestad et al., 2013; Zambonino Infante et al., 2008).

454 The development of the stomach is generally determined by the appearance of gastric glands,
455 while stomach functionality is characterized by the expression of pepsinogen and proton
456 pump (H^+/K^+ -ATPase) genes in the gastric glands, which are responsible for the production
457 of pepsin and hydrochloric acid, respectively (Darias et al., 2005; Darias et al., 2007a, 2007c;
458 Douglas et al., 1999; Gawlicka et al., 2001). However, the onset of acidic digestion may or
459 may not be synchronized with the morphological development of the gastric glands. For
460 instance, stomach functionality has shown to be delayed by 67 degree days (DD) in haddock,
461 *Melanogrammus aeglefinus* (Perez-Casanova et al., 2006), 147 DD in summer flounder,
462 *Paralichthys dentatus* (Huang et al., 1998), 154 DD in Atlantic halibut, *Hippoglossus*
463 *hippoglossus* (Murray et al., 2006), 195 DD in red porgy, *Pagrus pagrus* (Darias et al., 2005),
464 or 233 DD in Atlantic cod, *Gadus morhua* (Perez-Casanova et al., 2006). In *P. punctifer*, the
465 increase of *pga* expression observed in *P. punctifer* between 10 and 13 dpf was synchronized
466 with the appearance of the gastric glands (Gisbert et al., 2014)—as has also been observed in

467 other fish species, such as in winter flounder, *Pleuronectes americanus* (Douglas et al., 1999),
468 orange-spotted grouper, *Epinephelus coioides* (Feng et al., 2008), spotted rose snapper,
469 *Lutjanus guttatus* (Galaviz et al., 2012), or Sobaity sea bream, *Sparidentex hasta*
470 (Nazemroaya et al., 2020)—and indicated the achievement of the functional maturation of
471 the gastric glands, and hence marked the transition from the larval to the juvenile stage. These
472 results coincide with those we observed at enzymatic activity levels in this species (Castro-
473 Ruiz et al., 2019). The level of *pga* expression generally increases with development and
474 larval growth, which is associated with the increasing number of gastric glands in the stomach
475 (Darias et al., 2005; Darias et al., 2007c; Galaviz et al., 2012; Gao et al., 2013; Mir et al.,
476 2018; Moguel-Hernández et al., 2016; Murray et al., 2006), leading to full acidification
477 capacity and hence a more efficient protein digestion that can be attained several weeks after
478 the onset of acidic digestion (Darias et al., 2005; Hoehne-Reitan et al., 2001; Yúfera et al.,
479 2004). In *P. punctifer*, the exponential increase of *pga* expression after 13 dpf (14 mm TL)
480 is in accordance with the greater development both in number and size of the gastric glands
481 of the stomach observed histologically (Gisbert et al., 2014).

482 Although the expression profile of *pga* observed in *P. punctifer* is common to carnivorous
483 fish, *amy* expression did not follow the usual ontogenetic pattern observed in carnivorous
484 species, characterized by an initial high level of expression that gradually decreases until the
485 end of the larval stage (Cahu et al., 2004; Darias et al., 2006; Galaviz et al., 2015; Moguel-
486 Hernández et al., 2016; Péres et al., 1998; Srichanun et al., 2013; Zambonino Infante and
487 Cahu, 1994). Instead, *amy* expression in *P. punctifer* gradually increased until the end of the
488 larval development (10 dpf, 11 mm TL) and remained relatively high afterwards. The
489 capacity to synthesize α -amylase at larval stages is not only considered an indicator of the
490 maturation of the exocrine pancreas (Cahu et al., 2004; Cahu and Zambonino Infante, 1994),
491 but is also related to feeding habits (Kuz'mina, 1996). In particular, it has been reported that
492 α -amylase activity is higher in omnivorous than in carnivorous fish (Fernández et al., 2001;

493 Hidalgo et al., 1999; Kim et al., 2014). An increasing pattern of *amy* expression during
494 development has also been observed in the omnivorous thick lipped grey mullet *Chelon*
495 *labrosus* (Zouiten et al., 2008), and it has been suggested that constitutive expression of *amy*
496 may represent a true dietary specialization for herbivory and omnivory in prickleback fishes
497 (Kim et al., 2014). The feeding habits of *P. punctifer* larvae and early juveniles in the wild
498 are unknown; however, considering its *amy* expression profile, carbohydrates are probably
499 important in their larval diet. During this developmental period, it seems plausible that this
500 species displays an omnivorous feeding behavior with preference to carnivory and that
501 phytoplankton and invertebrates may be a significant component of the diet. Although *P.*
502 *punctifer* also presents histological and biochemical digestive characteristics of a carnivorous
503 species (Castro-Ruiz et al., 2019; Gisbert et al., 2014), this species has the ability to produce
504 high levels of amylase throughout the onset of acidic digestion, as has been observed later on
505 during the early juvenile stage (Castro-Ruiz et al., 2021). Similar findings were reported in
506 *Odax pullus*, an herbivorous fish that consumes starch-rich red algae as a juvenile, but not
507 much starch as an adult, and yet presents an elevated amylase activity in adulthood (Skea et
508 al., 2005). Between 18 and 24 dpf (18 and 26 mm TL, respectively), *P. punctifer* showed a
509 drastic increase in *amy* expression coinciding with the weaning period, in order to adapt the
510 enzymatic activity to the carbohydrate content (11% in *Artemia* vs. 20% in compound diet)
511 of the new diet supplied. This increase in *amy* expression resulted in an increase of the activity
512 of its enzyme (Castro-Ruiz et al., 2019), showing that the dietary modulation of the α -amylase
513 activity occurs at a transcriptional level during the juvenile stage in this species, as has been
514 observed in other fish species such as European sea bass, *Dicentrarchus labrax* (Péres et al.,
515 1998). The ability of *P. punctifer* to digest carbohydrates during the larval stage could
516 represent an advantage from an industrial perspective since this would permit the formulation
517 of larval feeds with lower protein content if the total replacement of live prey by compound
518 diets is achieved for this species (Darias et al., 2015). However, an increase in gene

519 expression does not necessarily mean that the fish is adequately using this source of energy.
520 Indeed, a recent study performed on the nutritional needs of *P. punctifer* during the early
521 juvenile stage (from 13 to 26 dpf) showed that a dietary carbohydrate content higher than
522 25% induced the production of α -amylase at higher levels than diets with lower carbohydrate
523 content, but reduced growth performance and induced fatty livers (Castro-Ruiz et al., 2021).
524 Therefore, results of digestive enzymes gene expression and activity should be considered
525 along with additional physiological responses, including nutrient interaction.

526 The importance of phospholipids in fish larval nutrition is widely recognized (reviewed in
527 Cahu et al., 2009). The secretory sPLA2-IB does not discriminate fatty acid species and needs
528 bile acid for full enzymatic activity in the intestinal lumen (Murakami et al., 2015). As with
529 α -amylase, an increase in *sPLA2-IB* gene expression during larval development is an
530 indicator of the maturation of the exocrine pancreas (Cahu et al., 2003). Similarly to our
531 results, an increase in sPLA2 gene expression and/or activity during development has also
532 been observed in other fish species such as in turbot, *Scophthalmus maximus* (Hoehne-Reitan
533 et al., 2003), Atlantic cod, *Gadus morhua* (Sæle et al., 2011), spotted rose snapper (Moguel-
534 Hernández et al., 2016), gilthead seabream, *Sparus aurata* (Mata-Sotres et al., 2016), large
535 yellow croaker, *Larimichthys crocea* (Cai et al., 2017), and California halibut, *Paralichthys*
536 *californicus* (Fuentes-Quesada and Lazo, 2018). Moreover, phospholipid content can also
537 affect the maturation of both the pancreas and the intestine, and the regulation of PLA2
538 activity mainly occurs at the transcriptional level (Cahu et al., 2003). For instance, the
539 regulation of *sPLA2-IB* expression by the exogenous diet has been observed in large yellow
540 croaker (Cai et al., 2017). The fact that the *PLA2-IB* gene expression in *P. punctifer* remained
541 high and constant after the onset of acidic digestion indicates that the expression levels were
542 adequate to digest the phospholipids present in the compound diet supplied at weaning. The
543 level of *sPLA2-IB* expression could be also considered an indicator of the nutritional

544 condition of fish, as a down-regulation of the expression of *sPLA2* has been observed in
545 fasted specimens (Benedito-Palos et al., 2014).

546 In the present study, *lpl* gene expression increased between 3 and 10 dpf (6 and 11 mm TL,
547 respectively), which coincides with the complete maturation of the intestine (Castro-Ruiz et
548 al., 2019; Gisbert et al., 2014), and continued to increase thereafter in response to the switch
549 of diet at weaning. A transcriptional regulation of this gene by the diet has also been found
550 in other fish species such as orange-spotted grouper (Li et al., 2016), spotted rose snapper
551 (Moguel-Hernández et al., 2016), and large yellow croaker (Cai et al., 2017).

552 *Try* expression in *P. punctifer* followed an expression profile that has been observed in
553 several fish species, which is characterized by an increase of its expression until the complete
554 formation and functionality of the stomach (Darias et al., 2007b; García-Gasca et al., 2006;
555 Kortner et al., 2011; Kurokawa et al., 2002; Mir et al., 2018; Murray et al., 2004; Parma et
556 al., 2013; Péres et al., 1998; Srichanun et al., 2013; Srivastava et al., 2002). Similar to what
557 has been reported for several fish species (Darias et al., 2005; Darias et al., 2007b; Galaviz
558 et al., 2011; Mir et al., 2018; Suzer et al., 2006), *try* expression in *P. punctifer* decreased from
559 10 dpf (11mm TL) concomitant with the increase of *pga* expression, indicating the change
560 from the basic and less efficient digestion of proteins in the anterior intestine to the acidic
561 digestion in the stomach that allows a more efficient digestion of complex proteins from this
562 point onward. However, this pattern can be modulated by the nutritional composition of the
563 diet, as the present study showed at weaning, where both *try* and *pga* expressions increased.
564 This is not surprising considering that both enzymes work together: pepsin makes a first
565 hydrolysis of protein molecules by selective cleavage at Phe, Tyr, and other aromatic amino
566 acids, and trypsin completes the process acting on Lys and Arg residues. As occurred with
567 *amy*, the expression profile of *try* coincided with that of the trypsin activity (Castro-Ruiz et
568 al., 2019), showing that the switch from *Artemia* to the compound diet induced a modulation

569 of the activity of this enzyme at the transcriptional level, as has also been observed in other
570 species (Péres et al., 1998).

571 *Ctr* followed a similar expression profile to *try* during the larval stage of *P. punctifer*,
572 denoting the complementary action of their corresponding enzymes trypsin and
573 chymotrypsin until the onset of acidic digestion (Rønnestad et al., 2013). However, the
574 opposite pattern observed after 13 dpf (decrease in *ctr* expression) did not coincide with the
575 increase in the activity of chymotrypsin (Castro-Ruiz et al., 2019), which would indicate that
576 the activity of this enzyme was regulated at a post-transcriptional level during the juvenile
577 stage in response to the dietary change. Alternatively, this difference in the expression profile
578 between *try* and *ctr* could be related to the role of trypsin in the activation of chymotrypsin.
579 Indeed, knowledge about the chymotrypsin dynamics and the importance of this enzyme in
580 the digestive processes during the early life stages of fish is still limited (Rønnestad et al.,
581 2013).

582

583 **5. Conclusions**

584 The gene expression of the digestive enzymes analyzed during the development of *P.*
585 *punctifer* followed the typical profile of a carnivorous species with the exception of *amy*,
586 which increased during development. Based on this, it is suggested that *P. punctifer* displays
587 an omnivorous feeding behavior with a preference towards carnivory during the early life
588 stage. The gene expression results, together with those previously obtained at the protein
589 activity level (Castro-Ruiz et al., 2019), showed that the enzymatic machinery of *P. punctifer*
590 is completely prepared before the onset of exogenous feeding at 4 dpf (6 mm TL) and reaches
591 its maturity between 10 and 13 dpf (11-14 mm TL), when individuals present a digestive
592 system with the adult mode of digestion. This indicates, from a digestive physiology
593 perspective, the transition from the larval to the juvenile stage, and the suitable moment for
594 weaning under culture conditions. Overall, these results contribute to the understanding of

595 the molecular basis of the ontogeny of the digestive system of a commercially important
596 Amazonian fish species and to the development of feeding strategies for fish species of
597 interest for aquaculture diversification in the region.

598

599 **Funding**

600 This work was funded by the International Joint Laboratory ‘Evolution and Domestication
601 of the Amazonian Ichthyofauna’ (LMI EDIA, IRD-IIAP-UAGRM, France, Peru and Bolivia)
602 and the IRTA. D.C.-R. benefited from a travel grant from the National Fund for Scientific,
603 Technological Development and Technological Innovation (FONDECYT, Peru) and from a
604 Sud-Nord mobilization grant from the IRD (France).

605

606 **Acknowledgments**

607 This work has been done within the framework of the network LARVAplus ‘Strategies for
608 the development and improvement of fish larvae production in Ibero-America’ (117RT0521)
609 funded by the Ibero-American Program of Science and Technology for Development
610 (CYTED, Spain).

611

612 **References**

- 613 Alves, A.L., Varela, E.S., Moro, G.V., Kirschnik, L.N.G., 2014. Riscos genéticos da
614 produção de híbridos de peixes nativos. Embrapa Pesca e Aquicultura, Palmas, Brazil.
- 615 Benedito-Palos, L., Ballester-Lozano, G., Pérez-Sánchez, J., 2014. Wide-gene expression
616 analysis of lipid-relevant genes in nutritionally challenged gilthead sea bream (*Sparus*
617 *aurata*). *Gene* 547, 34–42. <https://doi.org/10.1016/j.gene.2014.05.073>
- 618 Betancur-R, R., Wiley, E.O., Arratia, G., Acero, A., Bailly, N., Miya, M., Lecointre, G., Ortí,
619 G., 2017. Phylogenetic classification of bony fishes. *BMC Evol. Biol.* 17, 162.
620 <https://doi.org/10.1186/s12862-017-0958-3>
- 621 Buitrago-Suárez, U.A., Burr, B.M., 2007. Taxonomy of the catfish genus *Pseudoplatystoma*
622 *Bleeker* (Siluriformes: Pimelodidae) with recognition of eight species. *Zootaxa* 1512, 1–
623 38. <https://doi.org/10.11646/zootaxa.1512.1.1>
- 624 Cahu, C., Rønnestad, I., Grangier, V., Zambonino Infante, J.L., 2004. Expression and
625 activities of pancreatic enzymes in developing sea bass larvae (*Dicentrarchus labrax*) in

626 relation to intact and hydrolyzed dietary protein; involvement of cholecystokinin.
627 Aquaculture 238, 295–308. <https://doi.org/10.1016/j.aquaculture.2004.04.013>

628 Cahu, C.L., Gisbert, E., Villeneuve, L.A.N., Morais, S., Hamza, N., Wold, P.-A., Zambonino
629 Infante, J.L., 2009. Influence of dietary phospholipids on early ontogenesis of fish.
630 Aquac. Res. 40, 989–999. <https://doi.org/10.1111/j.1365-2109.2009.02190.x>

631 Cahu, C.L., Infante, J.L.Z., Barbosa, V., 2003. Effect of dietary phospholipid level and
632 phospholipid:neutral lipid value on the development of sea bass (*Dicentrarchus labrax*)
633 larvae fed a compound diet. Br. J. Nutr. 90, 21–28. <https://doi.org/10.1079/BJN2003880>

634 Cahu, C.L., Zambonino Infante, J.L., 1994. Early weaning of sea bass (*Dicentrarchus labrax*)
635 larvae with a compound diet: Effect on digestive enzymes. Comp. Biochem. Physiol. A
636 Physiol. 109, 213–222. [https://doi.org/10.1016/0300-9629\(94\)90123-6](https://doi.org/10.1016/0300-9629(94)90123-6)

637 Cai, Z., Xie, F., Mai, K., Ai, Q., 2017. Molecular cloning and genetic ontogeny of some key
638 lipolytic enzymes in large yellow croaker larvae (*Larimichthys crocea* R.). Aquac. Res.
639 48, 1183–1193. <https://doi.org/10.1111/are.12960>

640 Carolsfeld, J., Harvey, B., Ross, C., Baer, A., 2003. Migratory fishes of South America:
641 Biology, fisheries and conservation status. The World Bank, Washington.

642 Castro-Ruiz, D., Andree, K.B., Solovyev, M.M., Fernández-Méndez, C., García-Dávila, C.,
643 Cahu, C., Gisbert, E., Darias, M.J., 2021. The digestive function of *Pseudoplatystoma*
644 *punctifer* early juveniles is differentially modulated by dietary protein, lipid and
645 carbohydrate content and their ratios. Animals 11, 369.
646 <https://doi.org/10.3390/ani11020369>

647 Castro-Ruiz, D., Mozanzadeh, M.T., Fernández-Méndez, C., Andree, K.B., García-Dávila,
648 C., Cahu, C., Gisbert, E., Darias, M.J., 2019. Ontogeny of the digestive enzyme activity
649 of the Amazonian pimelodid catfish *Pseudoplatystoma punctifer* (Castelnau, 1855).
650 Aquaculture 504, 210–218. <https://doi.org/10.1016/j.aquaculture.2019.01.059>

651 Darias, M.J., Castro-Ruiz, D., Estivals, G., Quazuguel, P., Fernández-Méndez, C., Núñez-
652 Rodríguez, J., Clota, F., Gilles, S., García-Dávila, C., Gisbert, E., Cahu, C., 2015.
653 Influence of dietary protein and lipid levels on growth performance and the incidence of
654 cannibalism in *Pseudoplatystoma punctifer* (Castelnau, 1855) larvae and early juveniles.
655 J. Appl. Ichthyol. 31, 74–82. <https://doi.org/10.1111/jai.12978>

656 Darias, M.J., Murray, H.M., Gallant, J.W., Astola, A., Douglas, S.E., Yúfera, M., Martínez-
657 Rodríguez, G., 2006. Characterization of a partial α -amylase clone from red porgy
658 (*Pagrus pagrus*): Expression during larval development. Comp. Biochem. Physiol. B
659 Biochem. Mol. Biol. 143, 209–218. <https://doi.org/10.1016/j.cbpb.2005.11.010>

660 Darias, M.J., Murray, H.M., Gallant, J.W., Douglas, S.E., Yúfera, M., Martínez-Rodríguez,
661 G., 2007a. Ontogeny of pepsinogen and gastric proton pump expression in red porgy
662 (*Pagrus pagrus*): Determination of stomach functionality. Aquaculture 270, 369–378.
663 <https://doi.org/10.1016/j.aquaculture.2007.04.045>

664 Darias, M.J., Murray, H.M., Gallant, J.W., Douglas, S.E., Yúfera, M., Martínez-Rodríguez,
665 G., 2007b. The spatiotemporal expression pattern of trypsinogen and bile salt-activated
666 lipase during the larval development of red porgy (*Pagrus pagrus*, Pisces, Sparidae). Mar.
667 Biol. 152, 109–118. <https://doi.org/10.1007/s00227-007-0663-7>

668 Darias, M.J., Murray, H.M., Martínez-Rodríguez, G., Cárdenas, S., Yúfera, M., 2005. Gene

669 expression of pepsinogen during the larval development of red porgy (*Pagrus pagrus*).
670 *Aquaculture* 248, 245–252. <https://doi.org/10.1016/j.aquaculture.2005.04.044>

671 Darias, M.J., Ortiz-Delgado, J.B., Sarasquete, C., Martínez-Rodríguez, G., Yúfera, M.,
672 2007c. Larval organogenesis of *Pagrus pagrus* L., 1758 with special attention to the
673 digestive system development. *Histol. Histopathology* 22, 753–768.
674 <https://doi.org/10.14670/HH-22.753>

675 Dennis, E.A., 1994. Diversity of group types, regulation, and function of phospholipase A2.
676 *J. Biol. Chem.* 269, 13057–13060.

677 Douglas, S.E., Gawlicka, A., Mandla, S., Gallant, J.W., 1999. Ontogeny of the stomach in
678 winter flounder: characterization and expression of the pepsinogen and proton pump
679 genes and determination of pepsin activity. *J. Fish Biol.* 55, 897–915.
680 <https://doi.org/10.1111/j.1095-8649.1999.tb00729.x>

681 FAO, 2020. The State of World Fisheries and Aquaculture 2020. FAO, Rome, Italy.
682 <https://doi.org/10.4060/ca9229en>

683 Feng, S.Z., Li, W.S., Lin, H.R., 2008. Identification and expression characterization of
684 pepsinogen A in orange-spotted grouper, *Epinephelus coioides*. *J. Fish Biol.* 73, 1960–
685 1978. <https://doi.org/10.1111/j.1095-8649.2008.01999.x>

686 Fernández, I., Moyano, F.J., Díaz, M., Martínez, T., 2001. Characterization of α -amylase
687 activity in five species of Mediterranean sparid fishes (Sparidae, Teleostei). *J. Exp. Mar.*
688 *Biol. Ecol.* 262, 1–12. [https://doi.org/10.1016/S0022-0981\(01\)00228-3](https://doi.org/10.1016/S0022-0981(01)00228-3)

689 Fuentes-Quesada, J.P., Lazo, J.P., 2018. The effect of lipid type on lipid digestion enzymes
690 during larval development of the California halibut, *Paralichthys californicus*.
691 *Aquaculture* 488, 49–60. <https://doi.org/10.1016/j.aquaculture.2018.01.018>

692 Galaviz, M.A., García-Gasca, A., Drawbridge, M., Álvarez-González, C.A., López, L.M.,
693 2011. Ontogeny of the digestive tract and enzymatic activity in white seabass,
694 *Atractoscion nobilis*, larvae. *Aquaculture* 318, 162–168.
695 <https://doi.org/10.1016/j.aquaculture.2011.05.014>

696 Galaviz, M.A., García-Ortega, A., Gisbert, E., López, L.M., Gasca, A.G., 2012. Expression
697 and activity of trypsin and pepsin during larval development of the spotted rose snapper
698 *Lutjanus guttatus*. *Comp. Biochem. Physiol. B Biochem. Mol. Biol.* 161, 9–16.
699 <https://doi.org/10.1016/j.cbpb.2011.09.001>

700 Galaviz, M.A., López, L.M., García Gasca, A., Álvarez González, C.A., True, C.D., Gisbert,
701 E., 2015. Digestive system development and study of acid and alkaline protease digestive
702 capacities using biochemical and molecular approaches in totoaba (*Totoaba macdonaldi*)
703 larvae. *Fish Physiol. Biochem.* 41, 1117–1130. <https://doi.org/10.1007/s10695-015-0073-6>

704

705 Gao, C., Yang, R.B., Hu, W.B., Wang, J., 2013. Ontogeny of the stomach in yellow catfish
706 (*Pelteobagrus fulvidraco*): detection and quantification of pepsinogen and H⁺/K⁺ -
707 ATPase gene expression. *J. Anim. Physiol. Anim. Nutr.* 97, 20–26.
708 <https://doi.org/10.1111/j.1439-0396.2011.01238.x>

709 García-Gasca, A., Galaviz, M.A., Gutiérrez, J.N., García-Ortega, A., 2006. Development of
710 the digestive tract, trypsin activity and gene expression in eggs and larvae of the bullseye
711 puffer fish *Sphoeroides annulatus*. *Aquaculture* 251, 366–376.

712 <https://doi.org/10.1016/j.aquaculture.2005.05.029>

713 Gawlicka, A., Leggiadro, C.T., Gallant, J.W., Douglas, S.E., 2001. Cellular expression of the
714 pepsinogen and gastric proton pump genes in the stomach of winter flounder as
715 determined by in situ hybridization. *J. Fish Biol.* 58, 529–536.
716 <https://doi.org/10.1111/j.1095-8649.2001.tb02271.x>

717 Gisbert, E., Moreira, C., Castro-Ruiz, D., Öztürk, S., Fernández, C., Gilles, S., Nuñez, J.,
718 Duponchelle, F., Tello, S., Renno, J.F., García-Dávila, C., Darias, M.J., 2014.
719 Histological development of the digestive system of the Amazonian pimelodid catfish
720 *Pseudoplatystoma punctifer*. *Animal* 8, 1765–1776.
721 <https://doi.org/10.1017/S1751731114001797>

722 Gisbert, E., Ortiz-Delgado, J.B., Sarasquete, C., 2008. Nutritional cellular biomarkers in
723 early life stages of fish. *Histol. Histopathol.* 23, 1525–1539.
724 <https://doi.org/10.14670/HH-23.1525>

725 Guindon, S., Gascuel, O., 2003. A simple, fast, and accurate algorithm to estimate large
726 phylogenies by maximum likelihood. *Syst. Biol.* 52, 696–704.
727 <https://doi.org/10.1080/10635150390235520>

728 Hall, T.A., 1999. BioEdit: a user-friendly biological sequence alignment editor and analysis
729 program for Windows 95/98/NT. *Nucleic Acids Symp. Ser.* 41, 95–98.

730 Hashimoto, D.T., Prado, F.D. do, Senhorini, J.A., Foresti, F., Porto-Foresti, F., 2013.
731 Detection of post-F1 fish hybrids in broodstock using molecular markers: approaches for
732 genetic management in aquaculture. *Aquac. Res.* 44, 876–884.
733 <https://doi.org/10.1111/j.1365-2109.2012.03092.x>

734 Hashimoto, D.T., Prado, F.D., Senhorini, J.A., Foresti, F., Porto-Foresti, F., 2015.
735 Aquaculture of neotropical catfish hybrids: genetic strategies for conservation and
736 management, in: Regan, B. (Ed.), *Carp and Catfish: Biology, Behavior and Conservation*
737 *Strategies*. Nova Science Publishers, New York, pp. 1–30.

738 Hashimoto, D.T., Senhorini, J.A., Foresti, F., Porto-Foresti, F., 2012. Interspecific fish
739 hybrids in Brazil: management of genetic resources for sustainable use. *Rev. Aquac.* 4,
740 108–118. <https://doi.org/10.1111/j.1753-5131.2012.01067.x>

741 Hidalgo, M.C., Urea, E., Sanz, A., 1999. Comparative study of digestive enzymes in fish
742 with different nutritional habits. Proteolytic and amylase activities. *Aquaculture* 170,
743 267–283. [https://doi.org/10.1016/S0044-8486\(98\)00413-X](https://doi.org/10.1016/S0044-8486(98)00413-X)

744 Hoehne-Reitan, K., Kjørsvik, E., Reitan, K., 2001. Development of the pH in the intestinal
745 tract of larval turbot. *Mar. Biol.* 139, 1159–1164.
746 <https://doi.org/10.1007/s002270100653>

747 Hoehne-Reitan, K., Kjørsvik, E., Reitan, K.I., 2003. Lipolytic activities in developing turbot
748 larvae as influenced by diet. *Aquac. Int.* 11, 477–489.
749 <https://doi.org/10.1023/B:AQUI.0000004192.36467.0d>

750 Holt, G.J., 2011. *Larval Fish Nutrition*. John Wiley & Sons, Ltd, Ames, Iowa.

751 Huang, L., Schreiber, A.M., Soffientino, B., Bengtson, D.A., Specker, J.L., 1998.
752 Metamorphosis of summer flounder (*Paralichthys dentatus*): Thyroid status and the
753 timing of gastric gland formation. *J. Exp. Zool.* 280. [https://doi.org/10.1002/\(sici\)1097-010x\(19980415\)280:6<413::aid-jez5>3.0.co;2-q](https://doi.org/10.1002/(sici)1097-010x(19980415)280:6<413::aid-jez5>3.0.co;2-q)

754

755 IBGE, 2020. Pesquisa Pecuária Municipal: Produção da aquicultura [WWW Document].
756 URL <https://sidra.ibge.gov.br/Tabela/3940> (accessed 11.20.20).

757 Isaac, V.J., de Almeida, M.C., 2011. El consumo de pescado en la amazonía brasileña. FAO,
758 Rome.

759 Jézéquel, C., Tedesco, P.A., Bigorne, R., Maldonado-Ocampo, J.A., Ortega, H., Hidalgo, M.,
760 Martens, K., Torrente-Vilara, G., Zuanon, J., Acosta, A., Agudelo, E., Barrera Maure,
761 S., Bastos, D.A., Bogotá Gregory, J., Cabeceira, F.G., Canto, A.L.C., Carvajal-Vallejos,
762 F.M., Carvalho, L.N., Cella-Ribeiro, A., Covain, R., Donascimento, C., Dória, C.R.C.,
763 Duarte, C., Ferreira, E.J.G., Galuch, A.V., Giarrizzo, T., Leitão, R.P., Lundberg, J.G.,
764 Maldonado, M., Mojica, J.I., Montag, L.F.A., Ohara, W.M., Pires, T.H.S., Pouilly, M.,
765 Prada-Pedrerros, S., de Queiroz, L.J., Rapp Py-Daniel, L., Ribeiro, F.R.V., Ríos Herrera,
766 R., Sarmiento, J., Sousa, L.M., Stegmann, L.F., Valdiviezo-Rivera, J., Villa, F., Yunoki,
767 T., Oberdorff, T., 2020. A database of freshwater fish species of the Amazon Basin. *Sci.*
768 *Data* 7, 96. <https://doi.org/10.1038/s41597-020-0436-4>

769 Kapoor, B.G., Smit, H., Verighina, I.A., 1976. The alimentary canal and digestion in teleosts,
770 in: Russell, F.S., Yonge, M. (Eds.), *Advances in Marine Biology*. Academic Press, pp.
771 109–239. [https://doi.org/10.1016/S0065-2881\(08\)60281-3](https://doi.org/10.1016/S0065-2881(08)60281-3)

772 Katoh, K., Misawa, K., Kuma, K., Miyata, T., 2002. MAFFT: a novel method for rapid
773 multiple sequence alignment based on fast Fourier transform. *Nucleic Acids Res.* 30,
774 3059–3066. <https://doi.org/10.1093/nar/gkf436>

775 Keane, T.M., Creevey, C.J., Pentony, M.M., Naughton, T.J., McInerney, J.O., 2006.
776 Assessment of methods for amino acid matrix selection and their use on empirical data
777 shows that ad hoc assumptions for choice of matrix are not justified. *BMC Evol. Biol.* 6,
778 29. <https://doi.org/10.1186/1471-2148-6-29>

779 Kim, K.H., Horn, M.H., Sosa, A.E., German, D.P., 2014. Sequence and expression of an α -
780 amylase gene in four related species of prickleback fishes (Teleostei: Stichaeidae):
781 ontogenetic, dietary, and species-level effects. *J. Comp. Physiol. B* 184, 221–234.
782 <https://doi.org/10.1007/s00360-013-0780-1>

783 Kortner, T.M., Overrein, I., Øie, G., Kjørsvik, E., Bardal, T., Wold, P.-A., Arukwe, A., 2011.
784 Molecular ontogenesis of digestive capability and associated endocrine control in
785 Atlantic cod (*Gadus morhua*) larvae. *Comp. Biochem. Physiol. A. Mol. Integr. Physiol.*
786 160, 190–199. <https://doi.org/10.1016/j.cbpa.2011.05.033>

787 Kurokawa, T., Suzuki, T., Ohta, H., Kagawa, H., Tanaka, H., Unuma, T., 2002. Expression
788 of pancreatic enzyme genes during the early larval stage of Japanese eel *Anguilla*
789 *japonica*. *Fish. Sci.* 68, 736–744. <https://doi.org/10.1046/j.1444-2906.2002.00487.x>

790 Kuz'mina, V.V., 1996. Influence of age on digestive enzyme activity in some freshwater
791 teleosts. *Aquaculture* 148, 25–37. [https://doi.org/10.1016/S0044-8486\(96\)01370-1](https://doi.org/10.1016/S0044-8486(96)01370-1)

792 Lazo, J.P., Darias, M.J., Gisbert, E., 2011. Ontogeny of the Digestive Tract, in: Holt, G.J.
793 (Ed.), *Larval Fish Nutrition*. John Wiley & Sons, Ltd, pp. 3–46.
794 <https://doi.org/10.1002/9780470959862.ch1>

795 Li, S., Mai, K., Xu, W., Yuan, Y., Zhang, Y., Zhou, H., Ai, Q., 2016. Effects of dietary lipid
796 level on growth, fatty acid composition, digestive enzymes and expression of some lipid
797 metabolism related genes of orange-spotted grouper larvae (*Epinephelus coioides* H.).

798 Aquac. Res. 47, 2481–2495. <https://doi.org/10.1111/are.12697>

799 Ma, H., Cahu, C., Zambonino, J., Yu, H., Duan, Q., Le Gall, M.-M., Mai, K., 2005. Activities
800 of selected digestive enzymes during larval development of large yellow croaker
801 (*Pseudosciaena crocea*). *Aquaculture* 245, 239–248.
802 <https://doi.org/10.1016/j.aquaculture.2004.11.032>

803 Mata-Sotres, J.A., Martos-Sitcha, J.A., Astola, A., Yúfera, M., Martínez-Rodríguez, G.,
804 2016. Cloning and molecular ontogeny of digestive enzymes in fed and food-deprived
805 developing gilthead seabream (*Sparus aurata*) larvae. *Comp. Biochem. Physiol. B*
806 *Biochem. Mol. Biol.* 191, 53–65. <https://doi.org/10.1016/j.cbpb.2015.09.006>

807 Mead, J.R., Irvine, S.A., Ramji, D.P., 2002. Lipoprotein lipase: structure, function,
808 regulation, and role in disease. *J. Mol. Med. Berl. Ger.* 80, 753–769.
809 <https://doi.org/10.1007/s00109-002-0384-9>

810 Mir, I.N., Srivastava, P.P., Bhat, I.A., Muralidhar, A.P., Varghese, T., Gireesh-Babu, P., Jain,
811 K.K., 2018. Expression and activity of trypsin and pepsin during larval development of
812 Indian walking catfish (*Clarias magur*). *Aquaculture* 491, 266–272.
813 <https://doi.org/10.1016/j.aquaculture.2018.03.049>

814 Moguel-Hernández, I., Peña, R., Andree, K.B., Tovar-Ramirez, D., Bonacic, K., Dumas, S.,
815 Gisbert, E., 2016. Ontogeny changes and weaning effects in gene expression patterns of
816 digestive enzymes and regulatory digestive factors in spotted rose snapper (*Lutjanus*
817 *guttatus*) larvae. *Fish Physiol. Biochem.* 42, 1319–1334. [https://doi.org/10.1007/s10695-](https://doi.org/10.1007/s10695-016-0220-8)
818 [016-0220-8](https://doi.org/10.1007/s10695-016-0220-8)

819 Moyano, F.J., Díaz, M., Alarcón, F.J., Sarasquete, M.C., 1996. Characterization of digestive
820 enzyme activity during larval development of gilthead seabream (*Sparus aurata*). *Fish*
821 *Physiol. Biochem.* 15, 121–130. <https://doi.org/10.1007/BF01875591>

822 Murakami, M., Sato, H., Miki, Y., Yamamoto, K., Taketomi, Y., 2015. A new era of secreted
823 phospholipase A2. *J. Lipid Res.* 56, 1248–1261. <https://doi.org/10.1194/jlr.R058123>

824 Murray, H.M., Gallant, J.W., Johnson, S.C., Douglas, S.E., 2006. Cloning and expression
825 analysis of three digestive enzymes from Atlantic halibut (*Hippoglossus hippoglossus*)
826 during early development: Predicting gastrointestinal functionality. *Aquaculture* 252,
827 394–408. <https://doi.org/10.1016/j.aquaculture.2005.03.030>

828 Murray, H.M., Perez-Casanova, J.C., Gallant, J.W., Johnson, S.C., Douglas, S.E., 2004.
829 Trypsinogen expression during the development of the exocrine pancreas in winter
830 flounder (*Pleuronectes americanus*). *Comp. Biochem. Physiol. A. Mol. Integr. Physiol.*
831 138, 53–59. <https://doi.org/10.1016/j.cbpb.2004.02.020>

832 Nazemroaya, S., Nematollahi, M.A., Yazdanparast, R., Farahmand, H., Rezaie, A.,
833 Najafabadi, M.Z., 2020. Pepsinogen expression during larval development of a Persian
834 Gulf Sparid, *Sobaity*. *Aquaculture* 523, 735131.
835 <https://doi.org/10.1016/j.aquaculture.2020.735131>

836 Nelson, J.S., Grande, T.C., Wilson, M.V.H., 2016. *Fishes of the World*, 5th Edition. ed. John
837 Wiley & Sons, Hoboken, New Jersey.

838 Parma, L., Bonaldo, A., Massi, P., Yúfera, M., Martínez-Rodríguez, G., Gatta, P.P., 2013.
839 Different early weaning protocols in common sole (*Solea solea* L.) larvae: Implications
840 on the performances and molecular ontogeny of digestive enzyme precursors.

841 Aquaculture 414–415, 26–35. <https://doi.org/10.1016/j.aquaculture.2013.07.043>

842 Péres, A., Zambonino Infante, J.L., Cahu, C., 1998. Dietary regulation of activities and
843 mRNA levels of trypsin and amylase in sea bass (*Dicentrarchus labrax*) larvae. *Fish*
844 *Physiol. Biochem.* 19, 145–152. <https://doi.org/10.1023/A:1007775501340>

845 Perez-Casanova, J.C., Murray, H.M., Gallant, J.W., Ross, N.W., Douglas, S.E., Johnson,
846 S.C., 2006. Development of the digestive capacity in larvae of haddock
847 (*Melanogrammus aeglefinus*) and Atlantic cod (*Gadus morhua*). *Aquaculture* 251, 377–
848 401. <https://doi.org/10.1016/j.aquaculture.2005.06.007>

849 Pfaffl, M.W., 2001. A new mathematical model for relative quantification in real-time RT–
850 PCR. *Nucleic Acids Res.* 29, e45–e45. <https://doi.org/10.1093/nar/29.9.e45>

851 Rønnestad, I., Yúfera, M., Ueberschär, B., Ribeiro, L., Sæle, Ø., Boglione, C., 2013. Feeding
852 behaviour and digestive physiology in larval fish: current knowledge, and gaps and
853 bottlenecks in research. *Rev. Aquac.* 5, S59–S98. <https://doi.org/10.1111/raq.12010>

854 Ronquist, F., Huelsenbeck, J.P., 2003. MrBayes 3: Bayesian phylogenetic inference under
855 mixed models. *Bioinformatics* 19, 1572–1574.
856 <https://doi.org/10.1093/bioinformatics/btg180>

857 Sæle, Ø., Nordgreen, A., Olsvik, P.A., Hamre, K., 2011. Characterisation and expression of
858 secretory phospholipase A2 group IB during ontogeny of Atlantic cod (*Gadus morhua*).
859 *Br. J. Nutr.* 105, 228–237. <https://doi.org/10.1017/S0007114510003466>

860 Schneider, C.A., Rasband, W.S., Eliceiri, K.W., 2012. NIH Image to ImageJ: 25 years of
861 image analysis. *Nat. Methods* 9, 671–675. <https://doi.org/10.1038/nmeth.2089>

862 Skea, G.L., Mountfort, D.O., Clements, K.D., 2005. Gut carbohydrases from the New
863 Zealand marine herbivorous fishes *Kyphosus sydneyanus* (Kyphosidae), *Aplodactylus*
864 *arctidens* (Aplodactylidae) and *Odax pullus* (Labridae). *Comp. Biochem. Physiol. B*
865 *Biochem. Mol. Biol.* 140, 259–269. <https://doi.org/10.1016/j.cbpc.2004.10.008>

866 Srichanun, M., Tantikitti, C., Utarabhand, P., Kortner, T.M., 2013. Gene expression and
867 activity of digestive enzymes during the larval development of Asian seabass (*Lates*
868 *calcarifer*). *Comp. Biochem. Physiol. B Biochem. Mol. Biol.* 165, 1–9.
869 <https://doi.org/10.1016/j.cbpb.2013.02.005>

870 Srivastava, A.S., Kurokawa, T., Suzuki, T., 2002. mRNA expression of pancreatic enzyme
871 precursors and estimation of protein digestibility in first feeding larvae of the Japanese
872 flounder, *Paralichthys olivaceus*. *Comp. Biochem. Physiol. A. Mol. Integr. Physiol.* 132,
873 629–635. [https://doi.org/10.1016/s1095-6433\(02\)00107-1](https://doi.org/10.1016/s1095-6433(02)00107-1)

874 Suzer, C., Firat, K., Saka, Ş., 2006. Ontogenic development of the digestive enzymes in
875 common pandora, *Pagellus erythrinus*, L. larvae. *Aquac. Res.* 37, 1565–1571.
876 <https://doi.org/10.1111/j.1365-2109.2006.01598.x>

877 Talavera, G., Castresana, J., 2007. Improvement of phylogenies after removing divergent and
878 ambiguously aligned blocks from protein sequence alignments. *Syst. Biol.* 56, 564–577.
879 <https://doi.org/10.1080/10635150701472164>

880 Valladão, G.M.R., Gallani, S.U., Pilarski, F., 2018. South American fish for continental
881 aquaculture. *Rev. Aquac.* 10, 351–369. <https://doi.org/10.1111/raq.12164>

882 Winemiller, K.O., McIntyre, P.B., Castello, L., Fluet-Chouinard, E., Giarrizzo, T., Nam, S.,
883 Baird, I.G., Darwall, W., Lujan, N.K., Harrison, I., Stiassny, M.L.J., Silvano, R. a. M.,

884 Fitzgerald, D.B., Pelicice, F.M., Agostinho, A.A., Gomes, L.C., Albert, J.S., Baran, E.,
885 Petrere, M., Zarfl, C., Mulligan, M., Sullivan, J.P., Arantes, C.C., Sousa, L.M., Koning,
886 A.A., Hoeninghaus, D.J., Sabaj, M., Lundberg, J.G., Armbruster, J., Thieme, M.L., Petry,
887 P., Zuanon, J., Vilara, G.T., Snoeks, J., Ou, C., Rainboth, W., Pavanelli, C.S., Akama,
888 A., Soesbergen, A. van, Sáenz, L., 2016. Balancing hydropower and biodiversity in the
889 Amazon, Congo, and Mekong. *Science* 351, 128–129.
890 <https://doi.org/10.1126/science.aac7082>

891 Yúfera, M., Darias, M.J., 2007. The onset of exogenous feeding in marine fish larvae.
892 *Aquaculture* 268, 53–63. <https://doi.org/10.1016/j.aquaculture.2007.04.050>

893 Yúfera, M., Fernández-Díaz, C., Vidaurreta, A., Cara, J.B., Moyano, F.J., 2004.
894 Gastrointestinal pH and development of the acid digestion in larvae and early juveniles
895 of *Sparus aurata* (Pisces: Teleostei). *Mar. Biol.* 144, 863–869.
896 <https://doi.org/10.1007/s00227-003-1255-9>

897 Yúfera, M., Moyano, F.J., Martínez-Rodríguez, G., 2018. The Digestive Function in
898 Developing Fish Larvae and Fry. From Molecular Gene Expression to Enzymatic
899 Activity, in: Yúfera, M. (Ed.), *Emerging Issues in Fish Larvae Research*. Springer
900 International Publishing, Cham, pp. 51–86. [https://doi.org/10.1007/978-3-319-73244-](https://doi.org/10.1007/978-3-319-73244-2_6)
901 [2_6](https://doi.org/10.1007/978-3-319-73244-2_6)

902 Zambonino Infante, J.L., Cahu, C.L., 2001. Ontogeny of the gastrointestinal tract of marine
903 fish larvae. *Comp. Biochem. Physiol. Part C Toxicol. Pharmacol.* 130, 477–487.
904 [https://doi.org/10.1016/S1532-0456\(01\)00274-5](https://doi.org/10.1016/S1532-0456(01)00274-5)

905 Zambonino Infante, J.L., Cahu, C.L., 1994. Influence of diet on pepsin and some pancreatic
906 enzymes in sea bass (*Dicentrarchus labrax*) larvae. *Comp. Biochem. Physiol. A Physiol.*
907 109, 209–212. [https://doi.org/10.1016/0300-9629\(94\)90122-8](https://doi.org/10.1016/0300-9629(94)90122-8)

908 Zambonino Infante, J.L., Gisbert, E., Sarasquete, C., Navarro, I., Gutiérrez, J., Cahu, C.,
909 2008. Ontogeny and physiology of the digestive system of marine fish larvae, in: Cyrino,
910 J.E.P., Bureau, D.P., Kapoor, B.G. (Eds.), *Feeding and Digestive Functions in Fishes*.
911 Science Publishers, Enfield, New Hampshire, pp. 281–348.

912 Zouiten, D., Khemis, I.B., Besbes, R., Cahu, C., 2008. Ontogeny of the digestive tract of
913 thick lipped grey mullet (*Chelon labrosus*) larvae reared in “mesocosms.” *Aquaculture*
914 279, 166–172. <https://doi.org/10.1016/j.aquaculture.2008.03.039>

915

916

917

918 **Tables**

919

920 **Table 1.** Accession numbers and oligonucleotide primers used for PCR and relative
 921 quantification of gene expression of six digestive enzymes during development of *P.*
 922 *punctifer*. *Gadph* was used as reference gene. The amplification efficiency of each gene was
 923 close to 100%.

924

Gene name	Genbank accession number	Primer	Nucleotide sequence (5' – 3')	T _m (°C)	Product size (bp)
<i>Amy</i>	MT006358	PpuAmy F	CAACAACGYTGGGGTCAACATC	56.7	300
		PpuAmy R	GTCRATCAGCTTGTTCADGAAG	54.8	
		qpAMYPf F	CATGTGGCCTGGAGATTTACAGGC	60.3	113
		qpAMYPf R	CCACCCAGATCAATAACCTCCTGG	58.9	
<i>Try</i>	MT006359	Tryp1 F2	TGTGTCTGCTGCTCACTGC	57.9	384
		Tryp1 R2	GTCACCCTGGCAAGAGTCC	57.2	
		qpTRYPf F	TATGACTCCTGGACCATTGACAATG	57.0	190
		qpTRYPf R	CAGACACTGCAGCTTGTTGCCATC	61.4	
<i>Ctr</i>	MT006344	LgChym2F	GCGGTGCCTCACTCCTGGCCC	64.1	250
		LgChym2R	AGSRSGATGTCGTTGTTGATGGTG	59.1	
		qpCHTPf F	TGCCCCACTGCAATGTCAACACTTTC	61.0	100
		qpCHTPf R	ACCTTGGCAATCCTCATGACCTGG	61.2	
<i>sPLA2-IB</i>	MT006345	LgPhLipF	RRATGATCCTGTGYGTGATGCC	58.6	230
		LgPhLipR	CTCRCAGATGAACATCTCRCATTC	57.4	
		qpPLPPf F	ATGCAACATGATGCATGCTGGCC	61.6	100
		qpPLPPf R	GTTGTTGCTCTTGCAGGTGATTGTG	59.9	
<i>Lpl</i>	MT006346	LgLip-qF	AAGCTGGTGTCTGCCCTCTACG	61.0	250
		LgLip-qR	AGCCACATGTGCTCCCAGACTG	61.5	
		qpLLPPf F	TGCCAACGTCATAGTGGTGGACTG	59.1	130
		qpLLPPf R	GTAATCGAGTTCCATCATAAGCCAG	56.0	
<i>Pga</i>	MT006343	PEP 2F	GATGCTGACCTGTCTACTA	52.8	600
		PEP 2R	TTGATGGTAACACTGTCCAT	51.3	
		qpPEPPf F	TGTCTACCTAAGCAGCAACTCTC	56.4	160
		qpPEPPf R	ATGACAGAGGGATCCAGACCAGAG	59.4	
<i>Gadph</i>	MT006341	GAPD2HF	TATCAATGGATTCGGCCGCA	56.9	500
		GAPD2HR	TGGCAGTGATGGCATGAACT	57.0	
		qpGAPDHPf F	GGTCTTGAGGGCCTGCCTGCAG	64.3	160
		qpGADPHPf R	CGATGAGCTTGCCATCCTCGTG	60.6	

925

926

927 **Figure legends**

928 **Figure 1.** Larval and early juvenile growth in total length (mm) of *P. punctifer* from 0 to 24
929 days post fertilization. Data are represented as means \pm S.D. (n = 45). Values with a different
930 letter denote significant differences during development (one-way ANOVA, P < 0.05).

931 The ochre dashed lines indicate some key events in the ontogeny of the digestive system. The
932 green area indicates the transition period from the larval to the juvenile mode of digestion,
933 and the gray area indicates the weaning period. The feeding protocol is indicated by
934 horizontal arrows below the growth curve.

935

936 **Figure 2.** Phylogenetic tree for α -amylase protein sequences from several teleosts, inferred
937 from the Maximum Likelihood method (ML) and rooted on Anura species as outgroups.
938 Numbers close to nodes display branch support values for ML (based on 1000 bootstrapping)
939 followed by Bayesian posterior analysis. Full name of the species, GenBank accession
940 numbers and identity percentage of the α -amylase sequences with respect to that of *P.*
941 *punctifer* are shown in Table A1. The *amy* obtained in this study from *P. punctifer* is marked
942 with a black star. The clade of the order Siluriformes is demarcated by a violet dotted
943 rectangle. The two-colored columns on the right correspond to feeding habits and water
944 environments of the analyzed species. Code of colors is as follows: salmon pink, carnivorous;
945 yellow, omnivorous; green, herbivorous; dark blue, marine water; medium blue,
946 freshwater/brackish; light blue, freshwater. A, anadromous.

947

948 **Figure 3.** Phylogenetic tree for phospholipase A2 (PLA2) protein sequences from several
949 teleosts, inferred from the Maximum Likelihood method (ML) and rooted on Testudines and
950 Crocodylia species as outgroups. Numbers close to nodes display branch support values for
951 ML (based on 1000 bootstrapping) followed by Bayesian posterior analysis. Full name of the
952 species, GenBank accession numbers and identity percentage of the PLA2 sequences with

953 respect to that of *P. punctifer* are shown in Table A2. The *plA2* obtained in this study from
954 *P. punctifer* (*sPLA2-IB*) is marked with a black star. The clade of the order Siluriformes is
955 demarcated by a violet dotted rectangle. The two-colored columns on the right correspond to
956 feeding habits and water environments of the analyzed species. Code of colors is as follows:
957 salmon pink, carnivorous; yellow, omnivorous; dark blue, marine water; medium blue,
958 freshwater/brackish; light blue, freshwater. A, anadromous.

959

960 **Figure 4.** Phylogenetic tree for lipoprotein lipase (LPL) protein sequences from several
961 teleosts, inferred from the Maximum Likelihood method (ML) and rooted on Testudines and
962 Crocodylia species as outgroups. Numbers close to nodes display branch support values for
963 ML (based on 1000 bootstrapping) followed by Bayesian posterior analysis. Full name of the
964 species, GenBank accession numbers and identity percentage of the LPL sequences with
965 respect to that of *P. punctifer* are shown in Table A3. The *lpl* obtained in this study from *P.*
966 *punctifer* is marked with a black star. The clade of the order Siluriformes is demarcated by a
967 violet dotted rectangle. The two-colored columns on the right correspond to feeding habits
968 and water environments of the analyzed species. Code of colors is as follows: salmon pink,
969 carnivorous; yellow, omnivorous; dark blue, marine water; medium blue,
970 freshwater/brackish; light blue, freshwater. A, anadromous.

971

972 **Figure 5.** Phylogenetic tree for trypsin (TRY) protein sequences from several teleosts,
973 inferred from the Maximum Likelihood method (ML) and rooted on Testudines and
974 Crocodylia species as outgroups. Numbers close to nodes display branch support values for
975 ML (based on 1000 bootstrapping) followed by Bayesian posterior analysis. Full name of the
976 species, GenBank accession numbers and identity percentage of the TRY sequences with
977 respect to that of *P. punctifer* are shown in Table A4. The *try* obtained in this study from *P.*
978 *punctifer* is marked with a black star. The clade of the order Siluriformes is demarcated by a

979 violet dotted rectangle. The two-colored columns on the right correspond to feeding habits
980 and water environments of the analyzed species. Code of colors is as follows: salmon pink,
981 carnivorous; yellow, omnivorous; dark blue, marine water; medium blue,
982 freshwater/brackish; light blue, freshwater. A, anadromous.

983

984 **Figure 6.** Phylogenetic tree for chymotrypsin (CTR) protein sequences from several teleosts,
985 inferred from the Maximum Likelihood method (ML) and rooted on Anura species as
986 outgroups. Numbers close to nodes display branch support values for ML (based on 1000
987 bootstrapping) followed by Bayesian posterior analysis. Full name of the species, GenBank
988 accession numbers and identity percentage of the CTR sequences with respect to that of *P.*
989 *punctifer* are shown in Table A5. The *ctr* obtained in this study from *P. punctifer* is marked
990 with a black star. The clade of the order Siluriformes is demarcated by a violet dotted
991 rectangle. The two-colored columns on the right correspond to feeding habits and water
992 environments of the analyzed species. Code of colors is as follows: salmon pink, carnivorous;
993 yellow, omnivorous; green, herbivorous; dark blue, marine water; medium blue,
994 freshwater/brackish; light blue, freshwater.

995

996 **Figure 7.** Phylogenetic tree for pepsin (PGA) protein sequences from several teleosts,
997 inferred from the Maximum Likelihood method (ML) and rooted on two Anura species as
998 outgroups. Numbers close to nodes display branch support values for ML (based on 1000
999 bootstrapping) followed by Bayesian posterior analysis. Full name of the species, GenBank
1000 accession numbers and identity percentage of the PGA sequences with respect to that of *P.*
1001 *punctifer* are shown in Table A6. The *pga* obtained in this study from *P. punctifer* is marked
1002 with a black star. The clade of the order Siluriformes is demarcated by a violet dotted
1003 rectangle. The two-colored columns on the right correspond to feeding habits and water
1004 environments of the analyzed species. Code of colors is as follows: salmon pink, carnivorous;

1005 yellow, omnivorous; dark blue, marine water; medium blue, freshwater/brackish; light blue,
1006 freshwater.

1007

1008 **Figure 8.** Relative expression of α -amylase (*amy*), phospholipase A2 (*sPLA2-IB*), lipoprotein
1009 lipase (*lpl*), trypsinogen (*try*), chymotrypsin (*ctr*), and pepsinogen (*pga*) genes during the
1010 development of *P. punctifer* reared at 28 °C. The ochre dashed line indicates hatching (*ca.*
1011 18 hours post fertilization). The green area indicates the transition period from the larval to
1012 the juvenile mode of digestion, and the gray area indicates the weaning period. Data are
1013 represented as means \pm S.D. (n = 9). Values with a different letter denote significant
1014 differences during development (one-way ANOVA, P < 0.05).

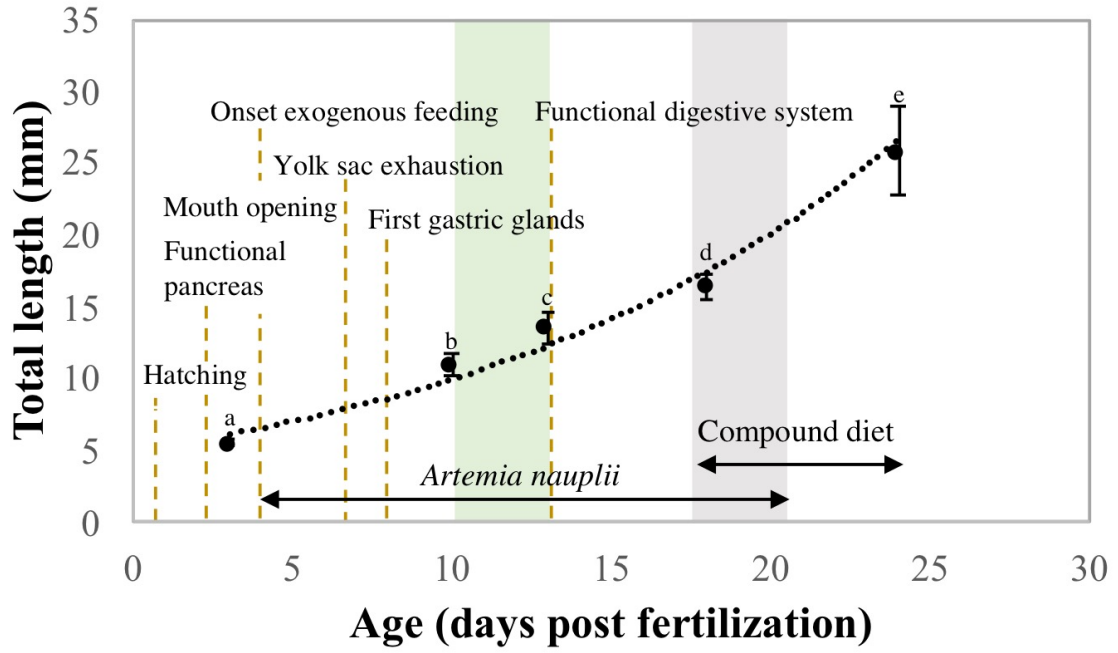

1015

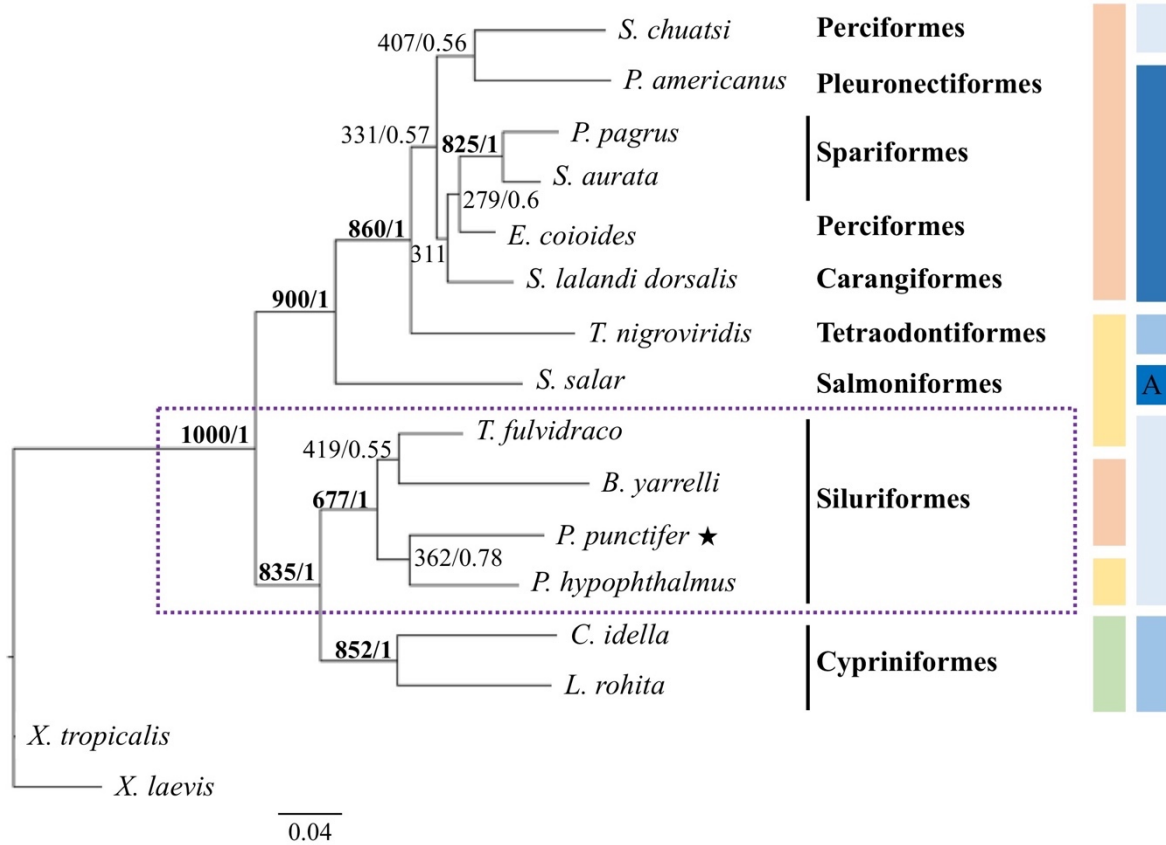

1016

1017

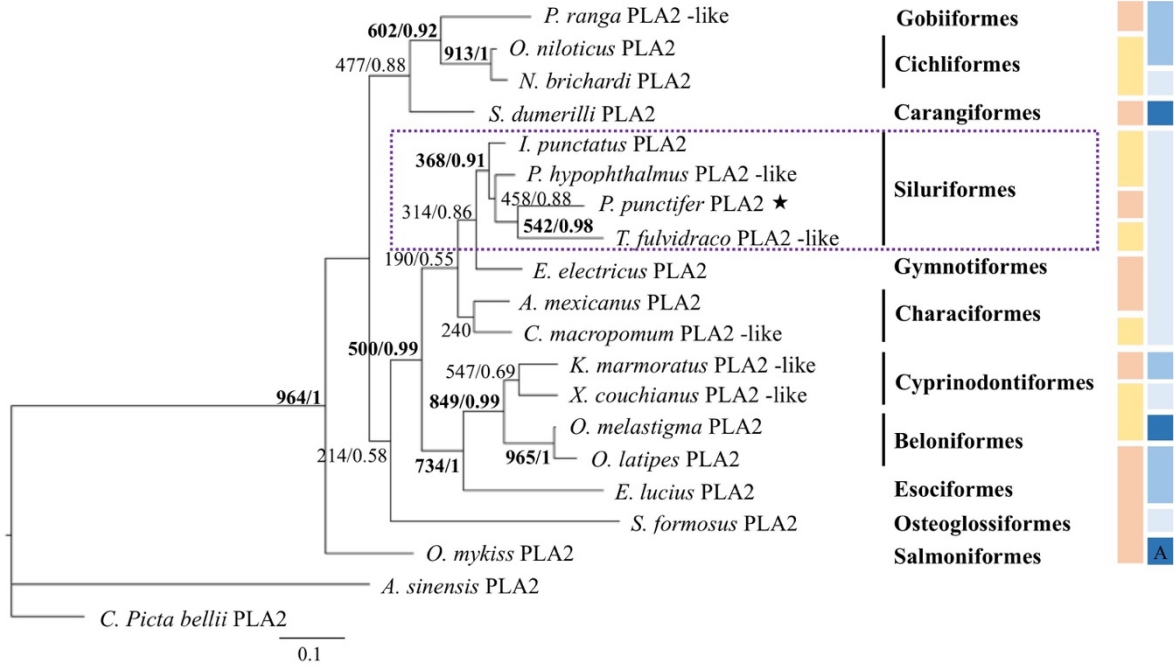

1018

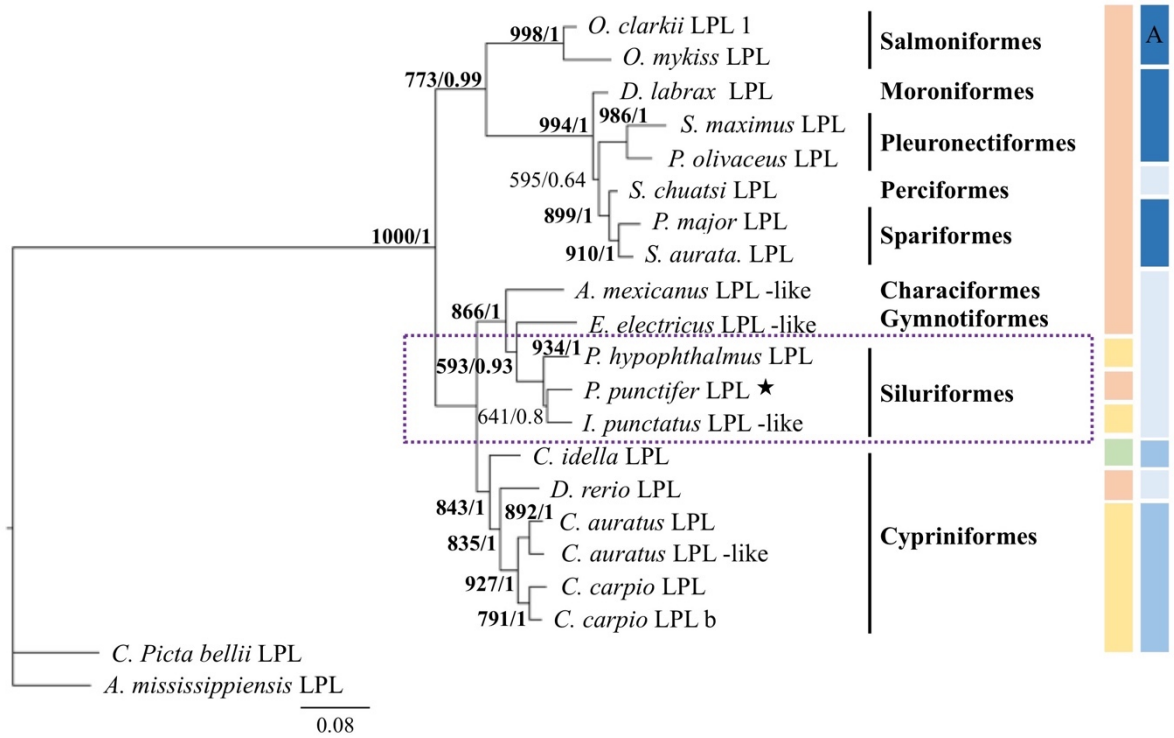

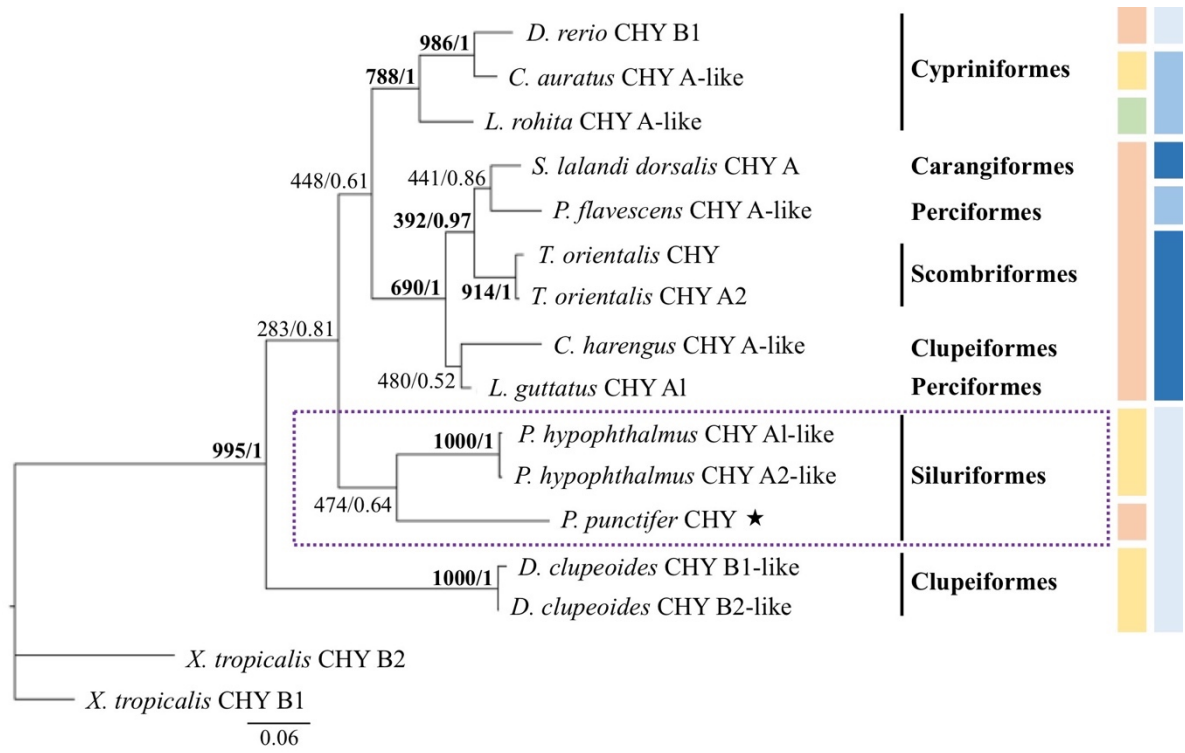
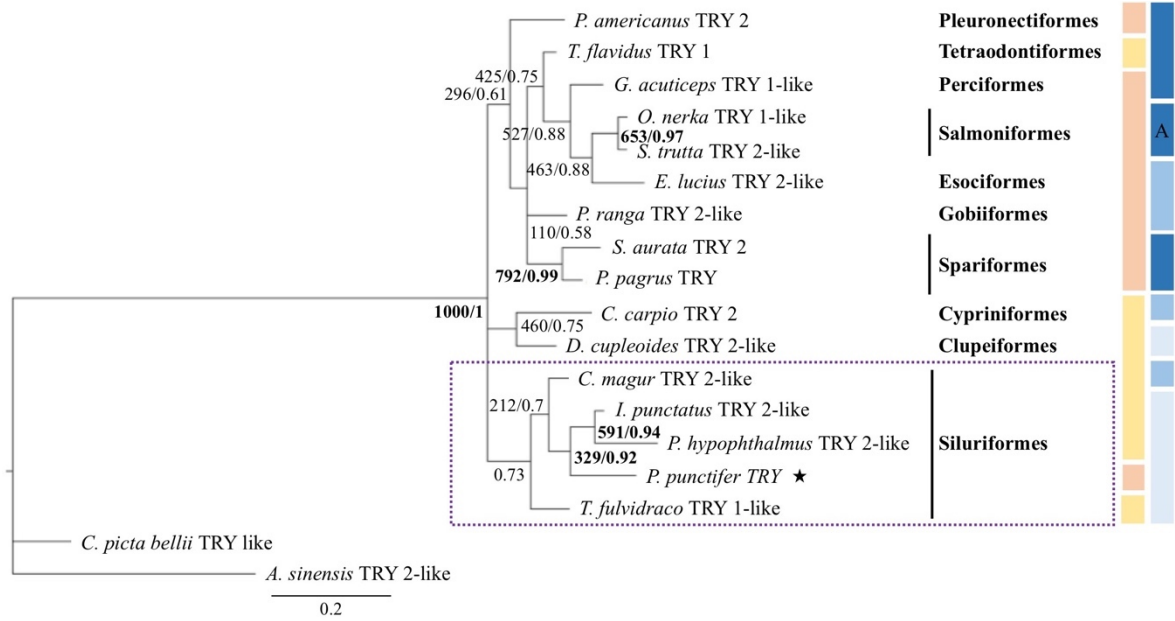

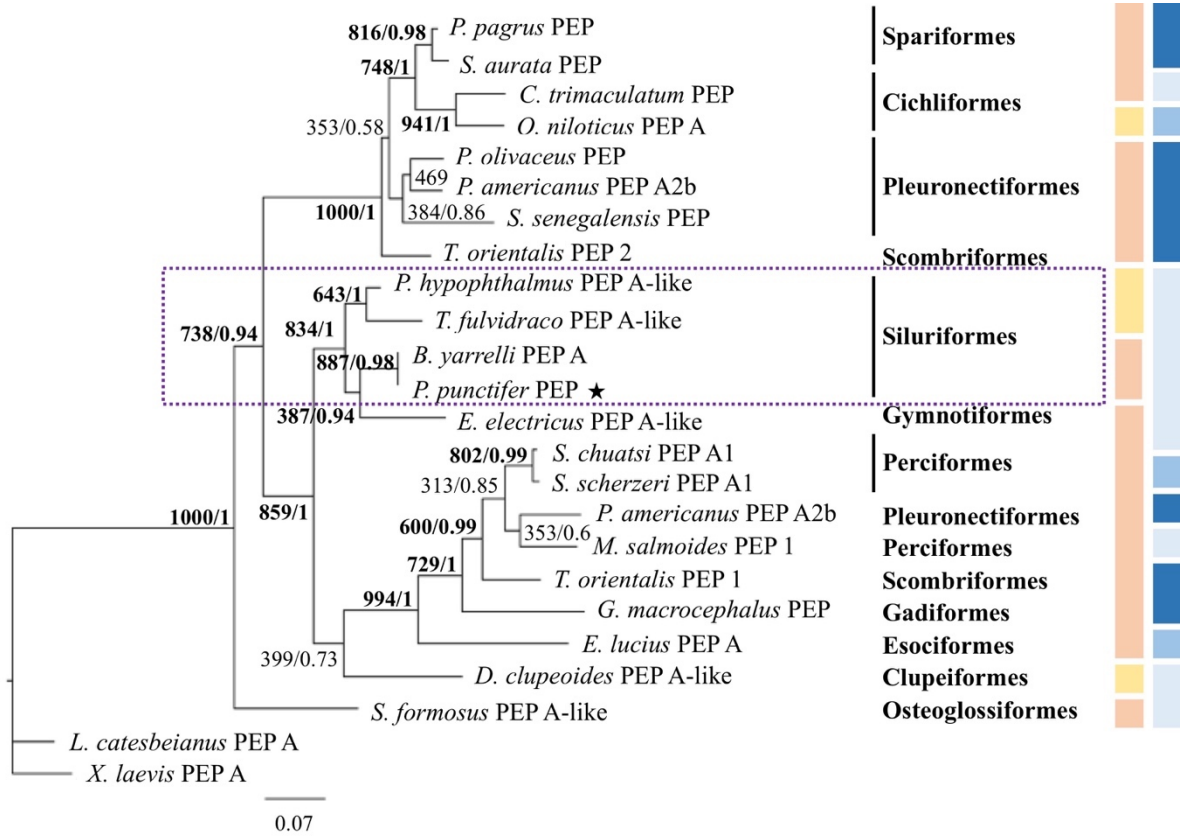

1021

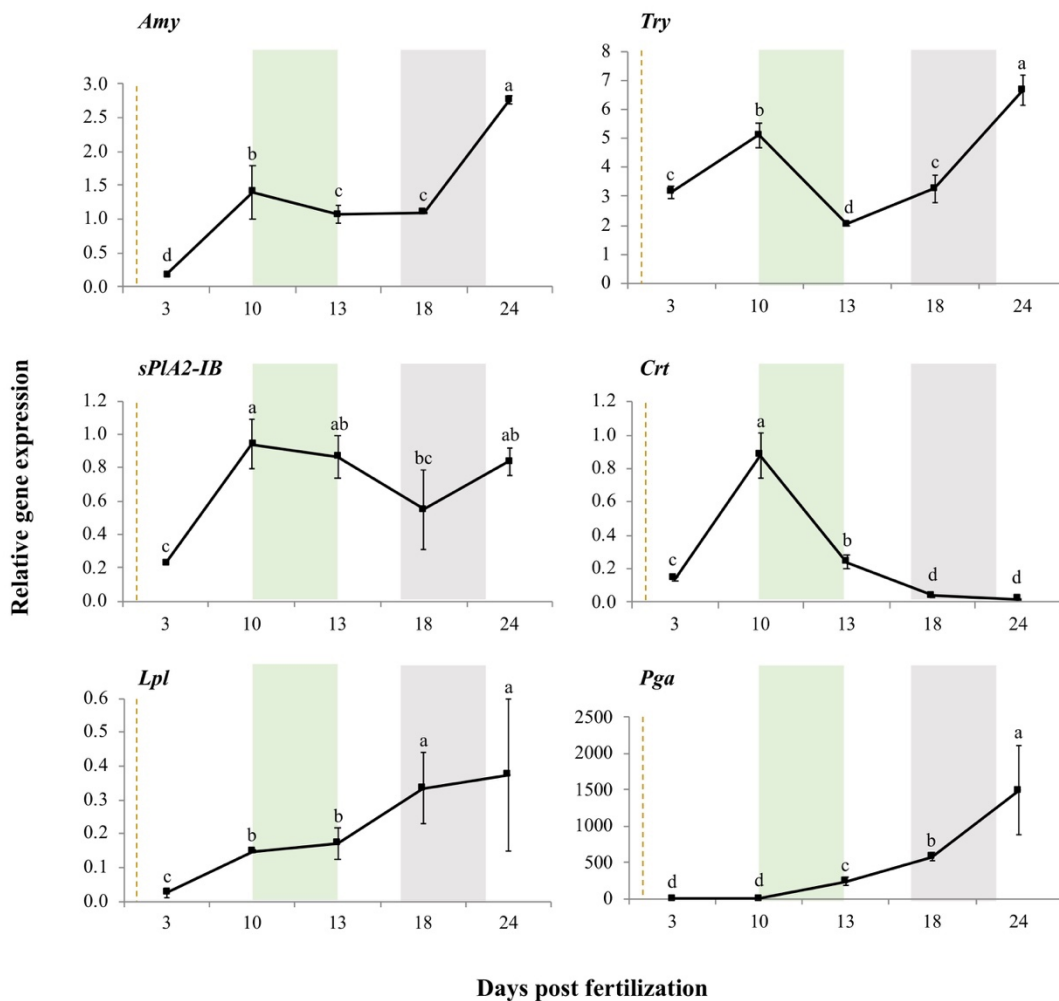

1022

1023 **Appendix A**

1024 **Table A1.** Sequence ID of the teleost species used for the phylogenetic analysis of α -amylase.
 1025 Information on the feeding habits of the species as well as on the percentage of identity at
 1026 amino acid level among *amy* sequences of *P. punctifer* and different species is also provided.
 1027 Species from the order Anura were used as outgroups.

Sequences ID	Species	Family	Order	Feeding habit	Identity (%)
AAX37668.1	<i>Tachysurus fulvidraco</i>	Bagridae	Siluriformes	Omnivorous	86.82
XP_026767155.1	<i>Pangasianodon hypophthalmus</i>	Pangasiidae	Siluriformes	Omnivorous	86.13
TST47702.1	<i>Bagarius yarrellii</i>	Sisoridae	Siluriformes	Carnivorous	84.54
ALB35087.1	<i>Sparus aurata</i>	Sparidae	Spariformes	Carnivorous	78.32
ACJ26844.1	<i>Epinephelus coioides</i>	Serranidae	Perciformes	Carnivorous	77.73
AAU93830.1	<i>Pagrus pagrus</i>	Sparidae	Spariformes	Carnivorous	77.53
XP_023263181.1	<i>Seriola lalandi dorsalis</i>	Carangidae	Carangiformes	Carnivorous	77.34
AAF65827.1	<i>Pseudopleuronectes americanus</i>	Pleuronectidae	Pleuronectiformes	Carnivorous	76.95
ACX35465.1	<i>Ctenopharyngodon idella</i>	Cyprinidae	Cypriniformes	Herbivorous	76.56
ACJ06746.1	<i>Siniperca chuatsi</i>	Sinipercidae	Perciformes	Carnivorous	76.37
AHY00275.1	<i>Labeo rohita</i>	Cyprinidae	Cypriniformes	Herbivorous	76.03
CAD20312.1	<i>Tetraodon nigroviridis</i>	Tetraodontidae	Tetraodontiformes	Omnivorous	75.83
XP_002938902.1	<i>Xenopus tropicalis</i>	Pipidae	Anura	Omnivorous	75.59
AAL87102.1	<i>Xenopus laevis</i>	Pipidae	Anura	Omnivorous	74.46
ABD13895.1	<i>Salmo salar</i>	Salmonidae	Salmoniformes	Carnivorous	72.07

1028

1029 **Table A2.** Sequence ID of the teleost species used for the phylogenetic analysis of
 1030 phospholipase A2. Information on the feeding habits of the species as well as on the
 1031 percentage of identity at amino acid level among *sPLA2-IB* sequences of *P. punctifer* and
 1032 different species is also provided. Species from the orders Testudines and Crocodilia were
 1033 used as outgroups.

Sequences ID	Species	Family	Order	Feeding habit	Identity (%)
XP_017345520	<i>Ictalurus punctatus</i>	Ictaluridae	Siluriformes	Omnivorous	97.22
XP_026765864	<i>Pangasianodon hypophthalmus</i>	Pangasiidae	Siluriformes	Omnivorous	97.22
XP_036451599	<i>Colossoma macropomum</i>	Serrasalminidae	Characiformes	Omnivorous	91.67
XP_026852122	<i>Electrophorus electricus</i>	Gymnotidae	Gymnotiformes	Carnivorous	91.43
XP_007241794	<i>Astyanax mexicanus</i>	Characidae	Characiformes	Carnivorous	88.89
XP_026988397.1	<i>Tachysurus fulvidraco</i>	Bagridae	Siluriformes	Omnivorous	86.11
XP_022609172.1	<i>Seriola dumerili</i>	Carangidae	Carangiformes	Carnivorous	80.56
XP_028270170.1	<i>Parambassis ranga</i>	Ambassidae	Gobiiformes	Carnivorous	75.00

XP_003445720.1	<i>Oreochromis niloticus</i>	Cichlidae	Cichliformes	Omnivorous	72.22
XP_006805482.1	<i>Neolamprologus brichardi</i>	Cichlidae	Cichliformes	Omnivorous	72.22
XP_010875989.1	<i>Esox lucius</i>	Esocidae	Esociformes	Carnivorous	72.22
XP_021461418.1	<i>Oncorhynchus mykiss</i>	Salmonidae	Salmoniformes	Carnivorous	72.22
XP_017280986.1	<i>Kryptolebias marmoratus</i>	Rivulidae	Cyprinodontiformes	Carnivorous	69.44
XP_024155431.1	<i>Oryzias melastigma</i>	Adrianichthyidae	Beloniformes	Omnivorous	69.44
XP_023816872.1	<i>Oryzias latipes</i>	Adrianichthyidae	Beloniformes	Carnivorous	69.44
XP_027881920.1	<i>Xiphophorus couchianus</i>	Poeciliidae	Cyprinodontiformes	Omnivorous	66.67
XP_018587154.2	<i>Scleropages formosus</i>	Osteoglossidae	Osteoglossiformes	Carnivorous	65.71
XP_005288773.1	<i>Chrysemys picta bellii</i>	Emydidae	Testudines		56.25
XP_014373187.1	<i>Alligator sinensis</i>	Alligatoridae	Crocodylia		45.16

1034

1035 **Table A3.** Sequence ID of the teleost species used for the phylogenetic analysis of lipoprotein
1036 lipase. Information on the feeding habits of the species as well as on the percentage of identity
1037 at amino acid level among *lpl* sequences of *P. punctifer* and different species is also provided.
1038 Species from the orders Testudines and Crocodylia were used as outgroups.

Sequences ID	Species	Family	Order	Feeding habit	Identity (%)
XP_026091567.1	<i>Carassius auratus</i>	Cyprinidae	Cypriniformes	Omnivorous	91.07
ACN66300.1	<i>Ctenopharyngodon idella</i>	Cyprinidae	Cypriniformes	Herbivorous	89.29
ACN37860.1	<i>Carassius auratus</i>	Cyprinidae	Cypriniformes	Omnivorous	89.29
AFL69952.1	<i>Oncorhynchus clarkii</i>	Salmonidae	Salmoniformes	Carnivorous	87.50
XP_007240188.2	<i>Astyanax mexicanus</i>	Characidae	Characiformes	Carnivorous	87.50
XP_026786482.1	<i>Pangasianodon hypophthalmus</i>	Pangasiidae	Siluriformes	Omnivorous	87.50
NP_571202.1	<i>Danio rerio</i>	Cyprinidae	Cypriniformes	Carnivorous	87.50
AIU47021.1	<i>Cyprinus carpio</i>	Cyprinidae	Cypriniformes	Omnivorous	87.50
CAB40545.1	<i>Oncorhynchus mykiss</i>	Salmonidae	Salmoniformes	Carnivorous	85.71
XP_026861273.1	<i>Electrophorus electricus</i>	Gymnotidae	Gymnotiformes	Carnivorous	85.71
NP_001316205.1	<i>Ictalurus punctatus</i>	Ictaluridae	Siluriformes	Omnivorous	85.71
ACN66301.1	<i>Cyprinus carpio</i>	Cyprinidae	Cypriniformes	Omnivorous	85.71
AFH75405.1	<i>Scophthalmus maximus</i>	Scophthalmidae	Pleuronectiformes	Carnivorous	82.14
ADY05335.1	<i>Paralichthys olivaceus</i>	Paralichthyidae	Pleuronectiformes	Carnivorous	82.14
CAL69901.1	<i>Dicentrarchus labrax</i>	Moronidae	Moroniformes	Carnivorous	80.36
ACI32420.1	<i>Siniperca chuatsi</i>	Siniperceidae	Perciformes	Carnivorous	80.36
BAE95413.1	<i>Pagrus major</i>	Sparidae	Spariformes	Carnivorous	78.57
AAS75120.1	<i>Sparus aurata</i>	Sparidae	Spariformes	Carnivorous	78.57
KYO35095.1	<i>Alligator mississippiensis</i>	Alligatoridae	Crocodylia		67.86
XP_005278929.1	<i>Chrysemys picta bellii</i>	Emydidae	Testudines		66.07

1039

1040 **Table A4.** Sequence ID of the teleost species used for the phylogenetic analysis of trypsin.
 1041 Information on the feeding habits of the species as well as on the percentage of identity at
 1042 amino acid level among *try* sequences of *P. punctifer* and different species is also provided.
 1043 Species from the orders Testudines and Crocodylia were used as outgroups.

Sequences ID	Species	Family	Order	Feeding habit	Identity (%)
XP_017311586.1	<i>Ictalurus punctatus</i>	Ictaluridae	Siluriformes	Omnivorous	86.18
KAF5908450.1	<i>Clarias magur</i>	Clariidae	Siluriformes	Omnivorous	85.37
XP_028837466.1	<i>Denticeps clupeoides</i>	Denticipitidae	Clupeiformes	Omnivorous	83.74
XP_026779498.1	<i>Pangasianodon hypophthalmus</i>	Pangasiidae	Siluriformes	Omnivorous	82.93
XP_027022007.1	<i>Tachysurus fulvidraco</i>	Bagridae	Siluriformes	Carnivorous	82.11
TWW54618.1	<i>Takifugu flavidus</i>	Tetraodontidae	Tetraodontiformes	Omnivorous	79.67
XP_034077433.1	<i>Gymnodraco acuticeps</i>	Bathydraconidae	Perciformes	Carnivorous	79.67
XP_028282177	<i>Parambassis ranga</i>	Ambassidae	Gobiiformes	Carnivorous	79.67
XP_029535066.1	<i>Oncorhynchus nerka</i>	Salmoninae	Salmoniformes	Carnivorous	78.86
ABE68639.1	<i>Sparus aurata</i>	Sparidae	Spariformes	Carnivorous	78.05
XP_029593925.1	<i>Salmo trutta</i>	Salmonidae	Salmoniformes	Carnivorous	78.05
XP_034144643	<i>Esox lucius</i>	Esocidae	Esociformes	Carnivorous	78.05
BAL04386.1	<i>Cyprinus carpio</i>	Cyprinidae	Cypriniformes	Omnivorous	76.42
AAC32752.1	<i>Pseudopleuronectes americanus</i>	Pleuronectidae	Pleuronectiformes	Carnivorous	73.17
AAX39390.1	<i>Pagrus pagrus</i>	Sparidae	Spariformes	Carnivorous	72.88
XP_023969437	<i>Chrysemys picta bellii</i>	Emydidae	Testudines		44.96
XP_025055986	<i>Alligator sinensis</i>	Alligatoridae	Crocodylia		41.54

1044

1045 **Table A5.** Sequence ID of the teleost species used for the phylogenetic analysis of
 1046 chymotrypsin. Information on the feeding habits of the species as well as on the percentage
 1047 of identity at amino acid level among *ctr* sequences of *P. punctifer* and different species is
 1048 also provided. Species from the order Anura were used as outgroups.

Sequences ID	Species	Family	Order	Feeding habit	Identity (%)
BAL72705.1	<i>Thunnus orientalis</i>	Scombridae	Scombriformes	Carnivorous	82.09
BAL14137.1	<i>Thunnus orientalis</i>	Scombridae	Scombriformes	Carnivorous	82.09
XP_026793160.1	<i>Pangasianodon hypophthalmus</i>	Pangasiidae	Siluriformes	Omnivorous	80.88
XP_026793159.2	<i>Pangasianodon hypophthalmus</i>	Pangasiidae	Siluriformes	Omnivorous	80.88
RXN21076.1	<i>Labeo rohita</i>	Cyprinidae	Cypriniformes	Herbivorous	80.60
XP_028434889.1	<i>Perca flavescens</i>	Percidae	Perciformes	Carnivorous	80.60
XP_031424552.1	<i>Clupea harengus</i>	Clupeidae	Clupeiformes	Carnivorous	80.60
AAH55574.1	<i>Danio rerio</i>	Cyprinidae	Cypriniformes	Carnivorous	76.12
XP_026071043.1	<i>Carassius auratus</i>	Cyprinidae	Cypriniformes	Omnivorous	76.12

XP_023261815.1	<i>Seriola lalandi dorsalis</i>	Carangidae	Carangiformes	Carnivorous	74.60
AAH89075.1	<i>Xenopus tropicalis</i>	Pipidae	Anura		73.13
NP_001011477.1	<i>Xenopus tropicalis</i>	Pipidae	Anura		73.12
XP_028812135.1	<i>Denticeps clupeioides</i>	Denticipitidae	Clupeiformes	Omnivorous	69.12
AIS23637.1	<i>Lutjanus guttatus</i>	Lutjanidae	Perciformes	Carnivorous	64.71
XP_028812134.1	<i>Denticeps clupeioides</i>	Denticipitidae	Clupeiformes	Omnivorous	63.01

1049

1050 **Table A6.** Sequence ID of the teleost species used for the phylogenetic analysis of pepsin.

1051 Information on the feeding habits of the species as well as on the percentage of identity at

1052 amino acid level among *pga* sequences of *P. punctifer* and different species is also provided.

1053 Species from the order Anura were used as outgroups.

Sequences ID	Species	Family	Order	Feeding habit	Identity (%)
TUC86171.1	<i>Bagarius yarrelli</i>	Sisoridae	Siluriformes	Carnivorous	100.00
XP_027011481.1	<i>Tachysurus fulvidraco</i>	Bagridae	Siluriformes	Omnivorous	93.18
XP_026771141.1	<i>Pangasianodon hypophthalmus</i>	Pangasiidae	Siluriformes	Omnivorous	93.18
XP_026864186.1	<i>Electrophorus electricus</i>	Gymnotidae	Gymnotiformes	Carnivorous	88.64
XP_028822570.1	<i>Denticeps clupeioides</i>	Denticipitidae	Clupeiformes	Omnivorous	75.00
ACF18588.1	<i>Siniperca scherzeri</i>	Sinipercidae	Perciformes	Carnivorous	75.00
ACF18587.1	<i>Siniperca chuatsi</i>	Sinipercidae	Perciformes	Carnivorous	75.00
XP_010890229.2	<i>Esox lucius</i>	Esocidae	Esociformes	Carnivorous	72.50
AAD56287.1	<i>Pseudopleuronectes americanus</i>	Pleuronectidae	Pleuronectiformes	Carnivorous	71.05
BAM76489.1	<i>Gadus macrocephalus</i>	Gadidae	Gadiformes	Carnivorous	70.45
BAG48263.1	<i>Thunnus orientalis</i>	Scombridae	Scombriformes	Carnivorous	70.45
AAD56288.1	<i>Pseudopleuronectes americanus</i>	Pleuronectidae	Pleuronectiformes	Carnivorous	70.27
ABX89618.1	<i>Sparus aurata</i>	Sparidae	Spariformes	Carnivorous	68.89
AAZ29603.1	<i>Pagrus pagrus</i>	Sparidae	Spariformes	Carnivorous	68.89
BAC87742.1	<i>Paralichthys olivaceus</i>	Paralichthyidae	Pleuronectiformes	Carnivorous	68.29
ASW27226.1	<i>Solea senegalensis</i>	Soleidae	Pleuronectiformes	Carnivorous	68.29
BAU37037.1	<i>Micropterus salmoides</i>	Centrarchidae	Perciformes	Carnivorous	68.18
BAG48264.1	<i>Thunnus orientalis</i>	Scombridae	Scombriformes	Carnivorous	66.67
KPP65830.1	<i>Scleropages formosus</i>	Osteoglossidae	Osteoglossiformes	Carnivorous	65.12
XP_003444873.1	<i>Oreochromis niloticus</i>	Cichlidae	Cichliformes	Omnivorous	64.44
AXB22642.1	<i>Cichlasoma trimaculatum</i>	Cichlidae	Cichliformes	Carnivorous	64.44
BAB20798.1	<i>Xenopus laevis</i>	Pipidae	Anura		60.00
BAB20092.1	<i>Lithobates catesbeianus</i>	Ranidae	Anura		60.00

1054

1055