



**HAL**  
open science

# Repeated equal-channel angular extrusion of polypropylene: Processing routes and back-pressure influence

R. Boulahia, Fahmi Zairi, Y. Voznyak, J.-M. Gloaguen

► **To cite this version:**

R. Boulahia, Fahmi Zairi, Y. Voznyak, J.-M. Gloaguen. Repeated equal-channel angular extrusion of polypropylene: Processing routes and back-pressure influence. *Materials Today Communications*, 2020, 10.1016/j.mtcomm.2020.101754 . hal-03256490

**HAL Id: hal-03256490**

**<https://hal.science/hal-03256490v1>**

Submitted on 24 Apr 2023

**HAL** is a multi-disciplinary open access archive for the deposit and dissemination of scientific research documents, whether they are published or not. The documents may come from teaching and research institutions in France or abroad, or from public or private research centers.

L'archive ouverte pluridisciplinaire **HAL**, est destinée au dépôt et à la diffusion de documents scientifiques de niveau recherche, publiés ou non, émanant des établissements d'enseignement et de recherche français ou étrangers, des laboratoires publics ou privés.



Distributed under a Creative Commons Attribution - NonCommercial 4.0 International License

## Repeated equal-channel angular extrusion of polypropylene: Processing routes and back-pressure influence

Randane Boulahia<sup>a</sup>, Fahmi Zaïri<sup>b\*</sup>, Yuri Voznyak<sup>c</sup>, Jean-Michel Gloaguen<sup>d</sup>

<sup>a</sup>University of Sciences and Technology Houari Boumediene, Laboratory of Advanced Mechanics, 16111 Algiers, Algeria

<sup>b</sup>University of Lille, Civil Engineering and geo-Environmental Laboratory (ULR 4515 LGCgE), 59000 Lille, France

<sup>c</sup>Centre of Molecular and Macromolecular Studies, Polish Academy of Sciences, 90363 Lodz, Poland

<sup>d</sup>University of Lille, Unité Matériaux et Transformations (UMR CNRS 8207 UMET), 59000 Lille, France

\*Corresponding author.

*E-mail address:* fahmi.zairi@polytech-lille.fr

### Abstract

Multi-pass equal channel angular extrusion (ECAE) process of polypropylene was investigated at room temperature using a 90° die-angle tooling outfitted with a back-pressure. The process was repeated until eight times using two different extrusion orientation routes: route A where the sample orientation is kept constant between each extrusion and route C where the sample is rotated by 180°. The crystalline textures were examined by WAXS measurements and the changes on the mechanical response were observed by full-field strain measurements during tensile tests. The use of a back-pressure turns the deformation behavior, along the flow direction of the ECAE products, from highly heterogeneous (characterized by a peculiar periodic shear-banding behavior) to roughly homogeneous and leads to completely different plastic processes in the crystalline phase. The textural differences subsequent to the multi-pass processing and the use of a back-pressure are the source of significant differences in tensile response along the flow direction. The observations show that the polypropylene processed via route C reaches more easily a saturation state than that obtained via route A with a strong beneficial influence of a back-pressure.

**Keywords:** High plastic deformation; Equal-channel angular extrusion; Multi-pass; Microstructure; Mechanical properties.

## **1. Introduction**

Equal-channel angular extrusion (ECAE) is a high-plastic-deformation technique consisting to extrude a specimen through two equal cross-section channels intersecting at a certain angle to form a single internal channel. The material is sheared across a thin layer when it crosses the angular zone of the channel. In ECAE products, substantial microstructure changes are thus induced by high degrees of simple shear plastic deformation. The geometrical constraints assigned to the channel keep constant the initial cross-section of the extruded specimen that can be thus extruded repetitively to accumulate severe plastic strains. The orientation of the specimen between successive extrusions (e.g. processing routes) may be changed provoking various textures and microstructures. The ECAE-induced deformation behavior depends on intrinsic material features [1] and various processing parameters such as number of extrusion sequences, processing route, friction, temperature, back-pressure (BP) and die geometry [2-3]. These parameters impact in turn the properties of the ECAE products. The application of the process on polymers has become the subject of considerable interest as reported in recent overviews of the state-of-the-art [4-5].

In this paper, the ECAE process is applied to polypropylene. Although the large deformation ability of this semicrystalline polymer is a well-known feature [6-7], the limit of possible accumulated plastic strains upon multi-pass ECAE remains largely undefined [8-16]. Furthermore, the peculiar behavior of periodic shear-banding in polypropylene reported by Boulahia et al. [12] in one ECAE pass was never investigated by repetitions of the process.

The goal of this paper is to examine in the case of polypropylene the relationships between key processing parameters (number of extrusion sequences, processing route and use of a BP), load/deformation behavior of the sample upon the solid-state extrusion process and microstructure/mechanical properties of the extruded sample.

## **2. Material and methods**

### **2.1. Material and specimens**

The studied material is a semicrystalline polypropylene supplied by Goodfellow in the form of 10 mm thick compression-molded plates. The number-average molar weight  $M_n$  and the weight-average molar weight  $M_w$ , given by the supplier, are 25kg/mol and 180kg/mol, respectively. Thermal properties and crystal content were determined by means of differential scanning calorimetry experiments. The glass transition temperature  $T_g$  and the melting temperature  $T_m$  are  $-20^\circ\text{C}$  and  $170^\circ\text{C}$ , respectively. The crystal content is about 55%.

Prismatic specimens of  $75 \times 10 \times 10$  mm were cut from the as-received polypropylene plates. They were then surfaced on the cutting facets and polished. Although material isotropy is expected, the specimens were cut along the same direction.

### **2.2. ECAE experiments**

A stainless steel ECAE die adapted on an electromechanical Instron-5800 testing machine was used to extrude the specimens through a L configuration channel. A picture of the experimental set-up is shown in Figure 1. The polypropylene piece is placed into the entrance channel and then pressed into the exit channel under the action of a ram that moves vertically thanks to the displacement of the cross-head of the testing machine. To avoid the formation of an open corner gap at the intersection area, i.e. shearing zone, between the die wall and the piece bottom surface, leading to a bending mechanism [11], a BP may be applied in opposition to the flow direction. The polypropylene pieces were extruded until eight times under two extrusion orientation scenarios illustrated in Figure 1: route A ( $0^\circ$  rotation between extrusions) and route C ( $180^\circ$  rotation between extrusions). All ECAE experiments were

conducted at an extrusion speed of 45 mm/min and at room temperature. The two channels were lubricated using silicone grease before each extrusion.

### **2.3. WAXS measurements**

Wide-angle X-ray scattering (WAXS) patterns were recorded at room temperature with the X-ray beam along the flow and transverse directions of the ECAE-processed pieces. The slices were prepared by careful diamond sawing. WAXS experiments were performed using the Ni-filtered Cu-K $\alpha$  radiation from a 2kW Panalytical sealed tube operated on a INEL 2000 generator at 40kV and 20mA. The 2D-WAXS patterns recorded on a digital CCD camera from Photonic Science Ltd were corrected for background scattering.

### **2.4. Tensile tests and full-field strain measurements**

Dumbbell-shaped specimens with dimension  $12 \times 4 \times 2$  mm were punched out from the ECAE-processed pieces as illustrated in Figure 2, the tensile axe being the ECAE flow direction. The tensile tests were carried out at room temperature and at a nominal strain rate of  $10^{-3} \text{ s}^{-1}$  using a displacement-control function. Load and displacement versus time were recorded during the tests and converted to average stress-strain curves. The digital image correlation method was used to determine the full-field displacements during the tensile tests. Randomized gray levels distributions were obtained using India ink sprayed with an airbrush at the specimen surface. The latter was illuminated by a strong white light beam. Images were registered by means of a CCD camera Imager E-lite 2M (LaVision GmbH) at regular intervals with resolution of 290 pixels/mm and size of  $1024 \times 1024$  pixels. The full-field displacement data were extracted using DaVis Software 8.0 (StrainMaster, LaVision GmbH) and then converted into true strains by means of a homemade visual basic program.

### **3. Results and discussion**

#### **3.1. Extrusion behavior**

The extrusion load is plotted as a function of the ram displacement in Figure 3 for the different ECAE processing parameters including number of extrusions, processing route and use of a BP. The figure gives an overview of the different types of plastic flow displayed by the polypropylene upon ECAE process. When no BP is applied, periodic load oscillations associated with plastic flow instabilities are observed. This peculiar behavior was firstly reported by Boulahia et al. [12] in one ECAE pass. It would be the result of a “stick-slip” process due to an unstable balance between the intrinsic material yield strength and the friction force between the die wall and the specimen surface. As a consequence, a periodic shear-banding behavior of the ECAE-processed piece occurs manifested by alternating sheared/unsheared bands tilted at roughly  $45^\circ$  from the flow direction along the sample length. The peculiar behavior is accompanied by more or less pronounced periodic waves along the top surface of the ECAE-processed piece. The unsheared bands remained opaque in transmitted light whereas the sheared bands appeared translucent due to the reduction of the light scattering resulting from the destruction of the spherulitic structure [9, 12]. Since the processing conditions are the same for routes A and C, the extrusion behavior is identical until the beginning of the second extrusion. The final deformation along the flow direction of the sample after the second and subsequent extrusions is strongly different when comparing both routes. This is evidenced by significant differences in load response. In route A, homothetic responses are obtained since it involves no rotation of the ECAE-processed piece between successive extrusions. The responses using route C show alternate increase and decrease in load after the maximum since the second and subsequent shearing of the ECAE-processed piece follow effective rotations of  $180^\circ$ . The shift of the maximum load corresponds to a material densification resulting in a sample length reduction. It worth noticing that due to

severe deformation at room temperature, the multi-extruded specimen can undergo surface damage but only conditions in which surface damage does not appear are presented in this study. The application of a BP leads to an increase in load magnitude due to both the pressure-sensitivity of the yield strength and the friction. The BP has a significant effect on the filling status of the extruded specimen and its deformation behavior upon ECAE. It significantly contributes to the disappearance of the alternating bands (and the periodic waves along the top surface of the specimen) as well as the load oscillations and consequently promotes the homogeneity of the plastic deformation along the ECAE-processed piece. Whereas no saturation is observed in route A, the application of a BP in route C results in a stationary state of the load after the second extrusion, since the evolution observed beyond that is almost negligible.

### **3.2. X-ray scattering**

Figure 4 provides the 2D-patterns after one ECAE pass. The results evidence a quite perfect crystalline isotropy along the flow direction whereas a strong crystallographic texturing of the (hk0) planes is observed along the transverse direction. The result for a shear-banding behavior, appearing when no BP is applied, is provided in Figure 4a for three 2D-patterns recorded from three successive translucent-opaque-translucent bands. A quite perfect crystalline isotropy remains in the middle unsheared band whereas a strong diagonal texturing appears in the two adjacent sheared bands. The latter corresponds to a preferred orientation of the (110), (040) and (130) planes. As shown in Figure 4b, the application of a BP results in a more uniform texturing along the extruded specimen and changes the plastic processes in the crystalline phase. They are characterized by scattering reinforcements on quadrant positions of the inner reflections. This reveals a double crystalline texturing of the (hk0) planes (with a

tilted orientation of the chain axis with respect to the ECAE shear plane) that would be due to the formation of a double population of oriented crystallites [12].

Figures 5 and 6 presents the 2D-patterns in the sheared bands after four and eight passes, respectively. The specimen orientation during successive passes plays a significant role in the crystallographic texturing due to the change in the ECAE shear plane orientation (Figure 1). A tilting of the strong diagonal texturing is observed with the consecutive shearing in route A. The application of a BP changes the plastic processes in the crystalline phase due to a tilting of the active crystallographic shear plane due to the pressure sensitivity. The route C leads to quite similar 2D-patterns with quadrant (hk0) reflections symmetric with regard to the ECAE shear plane. The observed saturation state at the macro-scale induced by the application of a BP in route C is confirmed by these local observations.

### **3.3. Tensile response**

Figure 7 shows the stress-strain curves of the polypropylene specimens machined from the ECAE-processed pieces. The ECAE process induces profound modifications of the polypropylene response with a significant effect of the processing parameters. The textural modifications subsequent to the first ECAE pass lead to both lower yield strength and strain-softening after yielding as compared to the as-received material. In route A, there is a significant increase of the yield strength between the second and the eight passes, but the differences observed on the yield strength are attenuated beyond the second pass when applying a BP. In route C, the number of passes has a slight effect on the stress magnitude but the specimens present superimposed stress-strain behaviors when applying a BP. The latter results highlight the fact that the extruded material polypropylene approaches its saturation state after the second passes; as observed also in the load response. It appears that the multi-pass processing has a significant effect on the strain-hardening ability and the strain at break.



The strain at break increases as a function of extrusion number in route A and decreases in route C. When a BP is used for extrusion, the strain at break does not change significantly in multi-pass processing in route C whereas it decreases in route A.

Illustrative examples of the strain localization along the gage length of the polypropylene specimens are presented in Figure 8 for a given cross-head displacement. The pattern of strain localization is completely different following the processing parameters. The periodic shear-banding occurring without BP results in multiple strain localizations (Figures 8a and c). The sheared bands with their crystallographic texturing are indeed highly favorable to plastic shear during the tensile testing along the flow direction. Beyond the yield point, the increase in stress allows to gradually deform the unsheared bands. As expected, the local strain is quite homogeneous when a BP is applied (Figures 8b and d).

#### **4. Conclusions**

Multi-pass ECAE experiments were conducted on polypropylene using a 90° die. The ECAE-induced deformation behavior, the resulting structural evolution and the resulting mechanical properties were investigated as a function of processing parameters. Several conclusions may be drawn from the present work:

- Without BP, the deformation behavior of the ECAE-processed piece is manifested by peculiar periodic shear-banding for routes A and C. The application of a BP triggers homogeneous plastic deformation by preventing instabilities and leads to completely different crystalline textures.
- The tensile responses of polypropylene processed via route C reach easily a saturation state contrary to those obtained via route A. No significant modifications in terms of strain-hardening ability and strain at break are found in route C when a BP is used for extrusion while the strain at break decreases without applying a BP.

## References

- [1] F. Zaïri, B. Aour, J.M. Gloaguen, M. Naït-Abdelaziz, J.M. Lefebvre, Influence of the initial yield strain magnitude on the materials flow in equal-channel angular extrusion process. *Scripta Mater.* 56 (2007) 105-108.
- [2] B. Aour, F. Zaïri, M. Naït-Abdelaziz, J.M. Gloaguen, O. Rahmani, J.M. Lefebvre, A computational study of die geometry and processing conditions effects on equal channel angular extrusion of a polymer, *Inter. J. Mech. Sci.* 50 (2008) 589-560.
- [3] B. Aour, F. Zaïri, M. Naït-Abdelaziz, J.M. Gloaguen, J.M. Lefebvre, Finite element analysis of plastic strain distribution in multipass ECAE process of high density polyethylene, *J. Man. Sci. Eng.* 131 (2009) 031016.
- [4] V.A. Beloshenko, Yu.V. Voznyak, I.Yu Reshidova, M. Naït-Abdelaziz, F. Zaïri, Equal-channel angular extrusion of polymers, *J. Polym. Res.* 20 (2013) 322-334.
- [5] V. Beloshenko, Iu. Vozniak, Y. Beygelzimer, Y. Estrin, R. Kulagin, Severe plastic deformation of polymers, *Mater. Trans.* 60 (2019) 1192-1202.
- [6] C. G'sell, V. Favier, J.M. Hiver, A. Dahoun, M.J. Philippe, G.R. Canova, Microstructure transformation and stress-strain behavior of isotactic polypropylene under large plastic deformation, *Polym. Eng. Sci.* 37, 19971702-1711.
- [7] A. Codolini, Q.M. Li, A. Wilkinson, Mechanical characterization of thin injection-moulded polypropylene specimens under large in-plane shear deformations, *Polym. Test.* 69 (2018) 485-489.
- [8] B. Campbell, G. Edward, Equal channel angular extrusion of polyalkenes, *Plast. Rubb. Comp. Proc. Appl.* 28 (1999) 467-475.
- [9] A. Phillips, P.W. Zhu, G. Edward, Simple shear deformation of polypropylene via the equal channel angular extrusion process, *Macromol.* 39 (2006) 5796-5803.
- [10] M. Kitagawa, T. Kozaki, ECAP process in polypropylene, *Zairyo J. Soc. Mater. Sci.* 55 (2006) 37-41.
- [11] F. Zaïri, B. Aour, J.M. Gloaguen, M. Naït-Abdelaziz, J.M. Lefebvre, Steady plastic flow of a polymer during equal channel angular extrusion process: experiments and numerical modeling, *Polym. Eng. Sci.* 48 (2008) 1015-1021.
- [12] R. Boulahia, J.M. Gloaguen, F. Zaïri, M. Naït-Abdelaziz, R. Seguela, T. Boukharouba, J.M. Lefebvre, Deformation behaviour and mechanical properties of polypropylene processed by equal channel angular extrusion: Effects of back-pressure and extrusion velocity, *Polym.* 50 (2009) 5508-5517.
- [13] B. Aour, F. Zaïri, R. Boulahia, M. Naït-Abdelaziz, J.M. Gloaguen, J.M. Lefebvre, Experimental and numerical study of ECAE deformation of polyolefins, *Comp. Mater. Sci.* 45 (2009) 646-652.
- [14] V.A. Beloshenko, V.N. Varyukhin, A.V. Voznyak, Y. Voznyak, Equal-channel multiangular extrusion of semicrystalline polymers, *Polym. Eng. Sci.* 50 (2010) 1000-1006.
- [15] T. Wang, S. Tang, J. Chen, Effects of processing route on morphology and mechanical behavior of polypropylene in equal channel angular extrusion, *J. Appl. Polym. Sci.* 122 (2011) 2146-2158.
- [16] T.L. Wang, S.C. Tang, J.D. Chen, Microstructural evolution and its effect on mechanical properties of isotactic polypropylene by shear plastic deformation at elevated temperatures, *J. Macromol. Sci. Part B: Phys.* 54 (2015) 1309-1322.

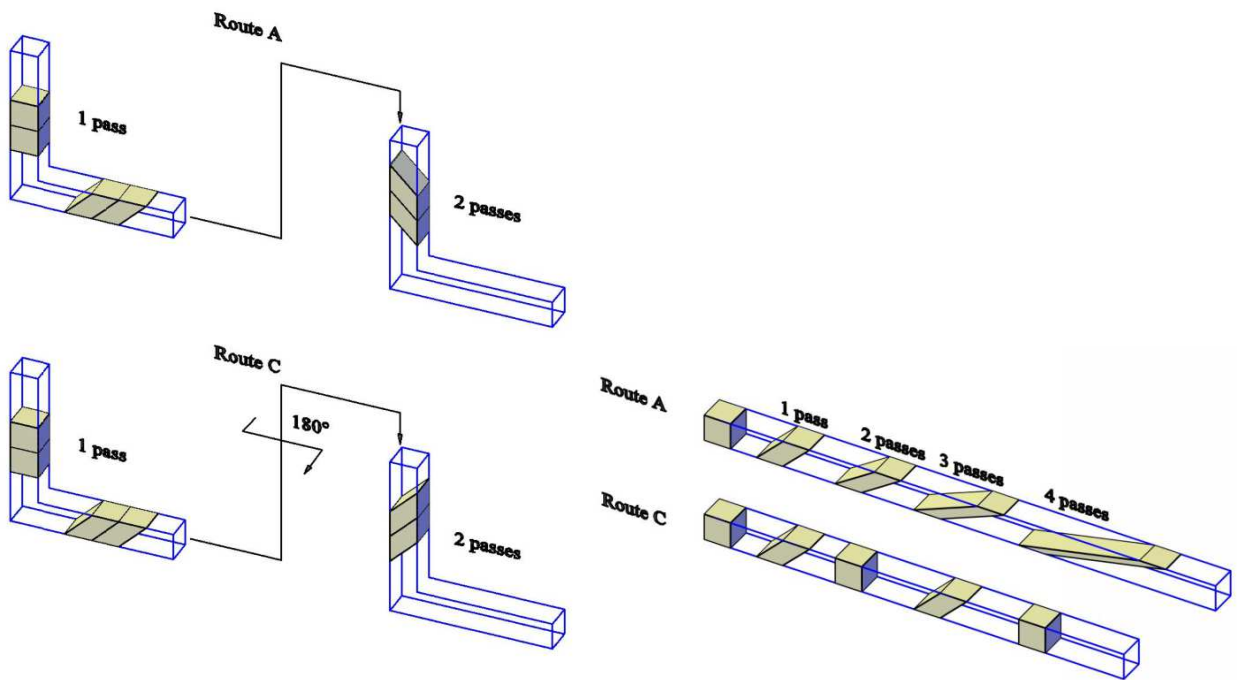
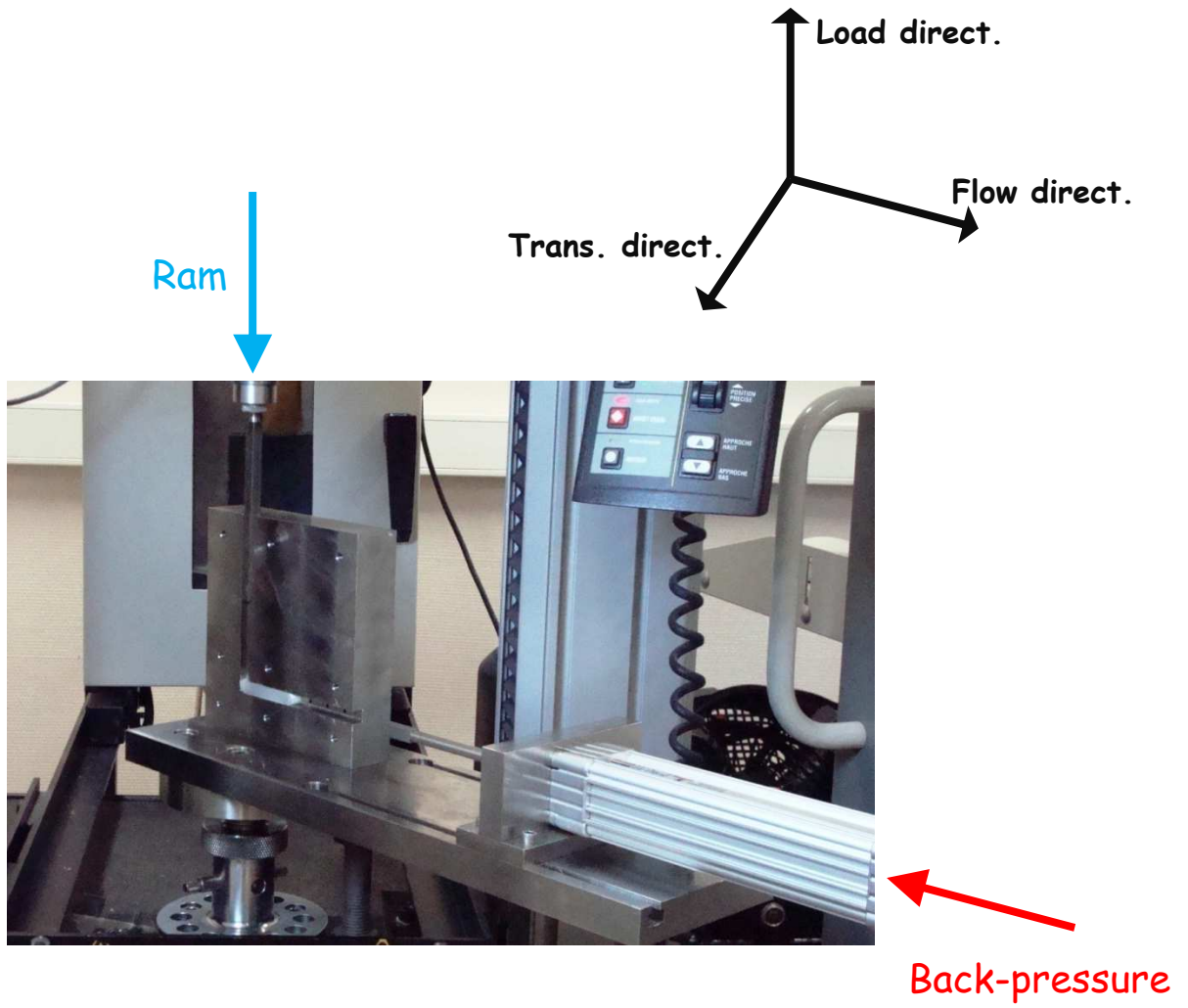

Figure 1. Solid state extrusion equipment placed in the testing machine. The drawing shows the processing routes A and C.

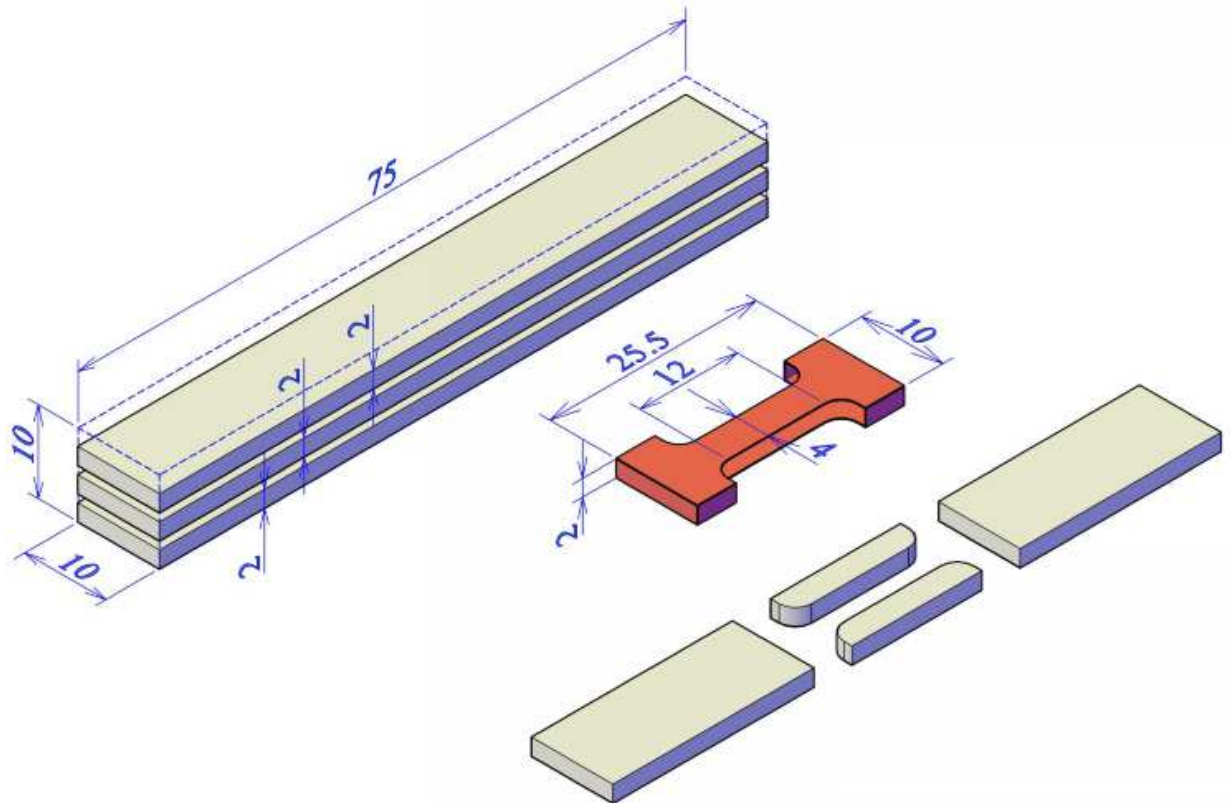
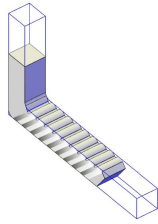
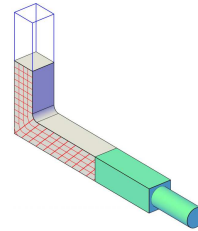

Figure 2. Preparation of a tensile specimen from an ECAE-processed piece.



**Without BP**



**With BP**

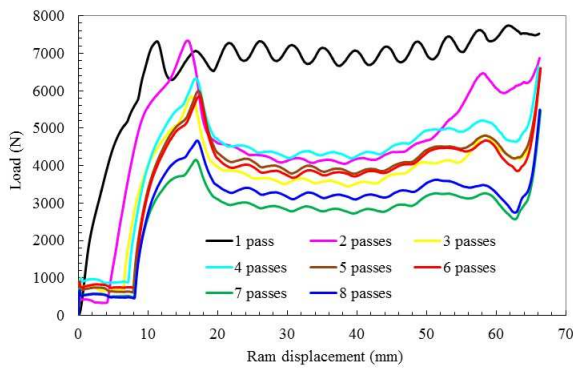

(a)

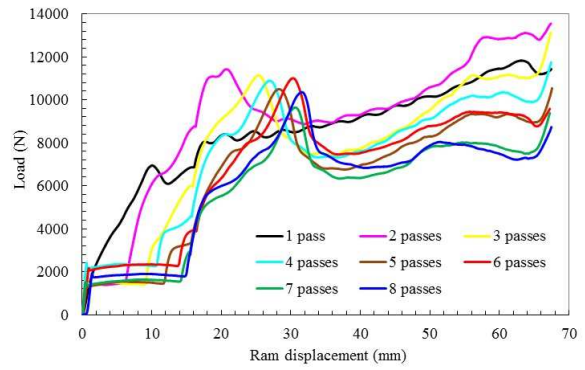

(b)

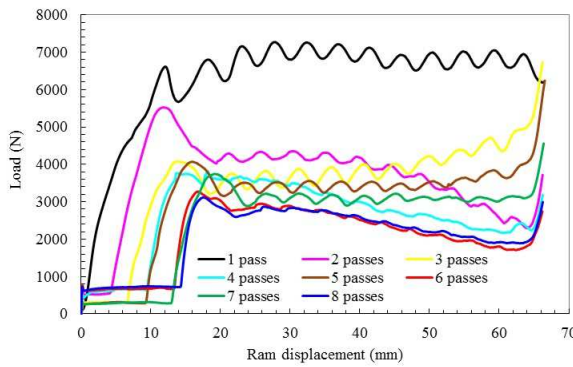

(c)

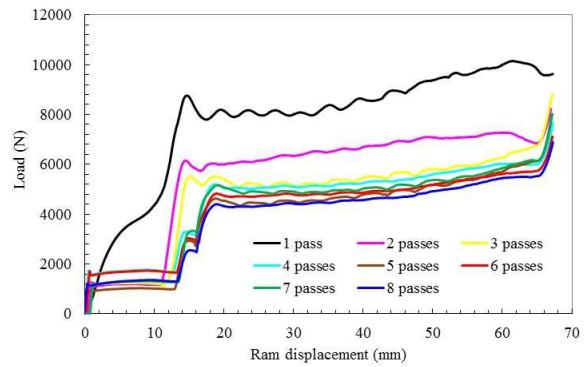

(d)

Figure 3. Load-ram displacement curves for successive extrusions: (a) route A and BP = 0, (b) route A and BP = 900N, (c) route C and BP = 0, (d) route C and BP = 900N.

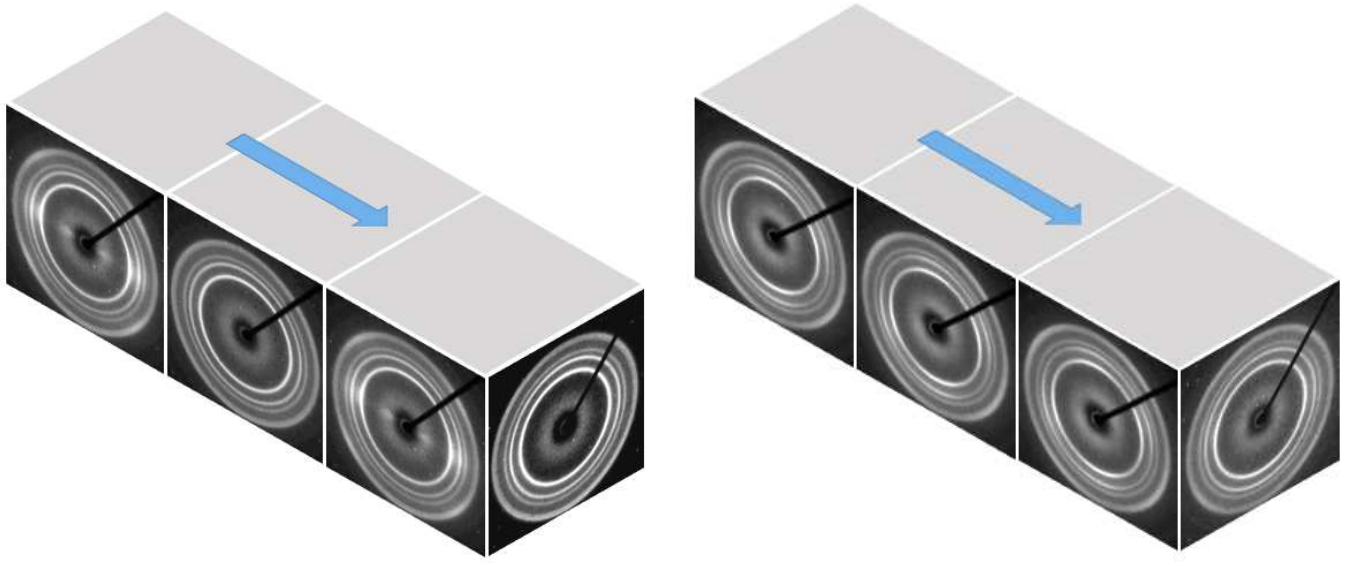

(a)

(b)

Figure 4. 2D-WAXS patterns after one extrusion: (a) BP = 0, (b) BP = 900 N. The arrow indicates the flow direction.

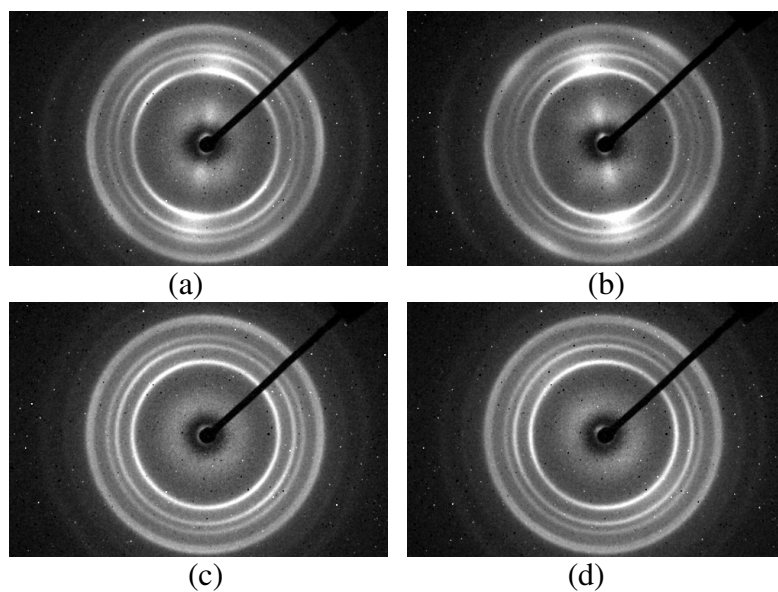

Figure 5. 2D-WAXS patterns, viewing along the transversal direction, after four extrusions: (a) route A and BP = 0, (b) route A and BP = 900N, (c) route C and BP = 0, (d) route C and BP = 900N.

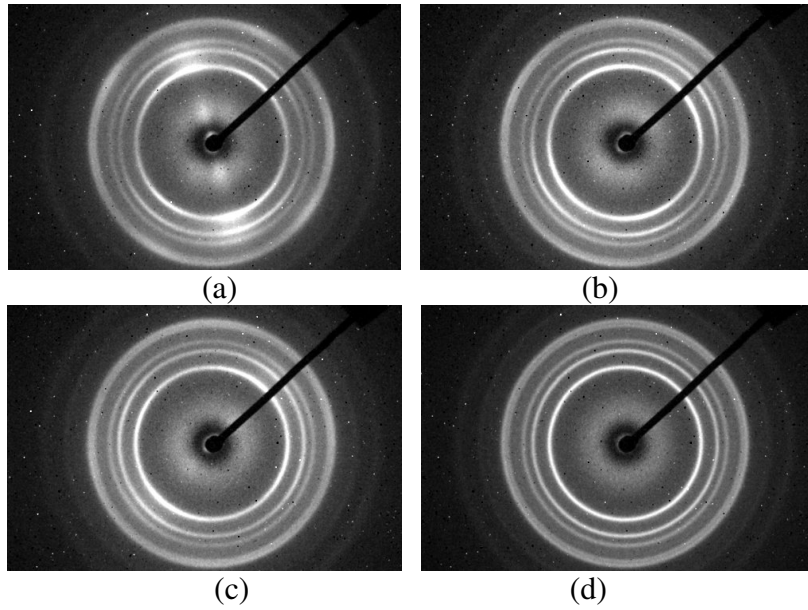
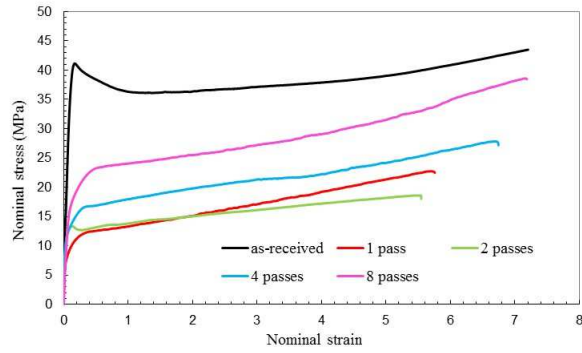
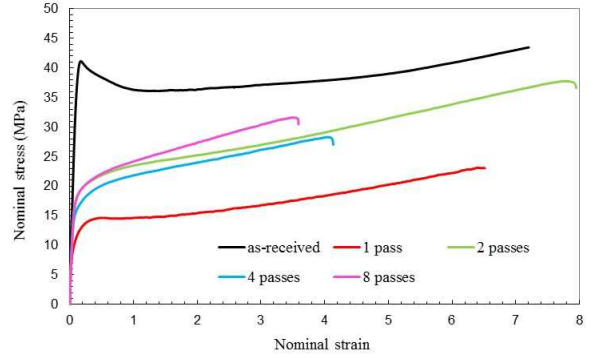

Figure 6. 2D-WAXS patterns, viewing along the transversal direction, after eight extrusions: (a) route A and BP = 0, (b) route A and BP = 900N, (c) route C and BP = 0, (d) route C and BP = 900N.





(a)



(b)

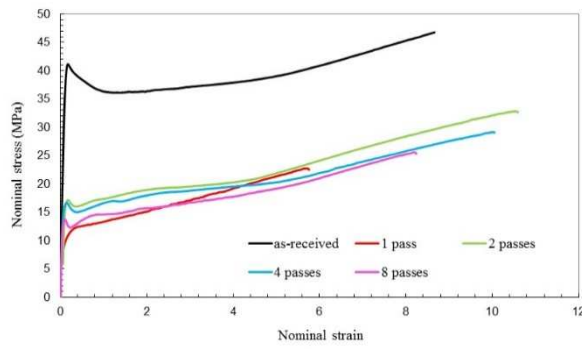

(c)

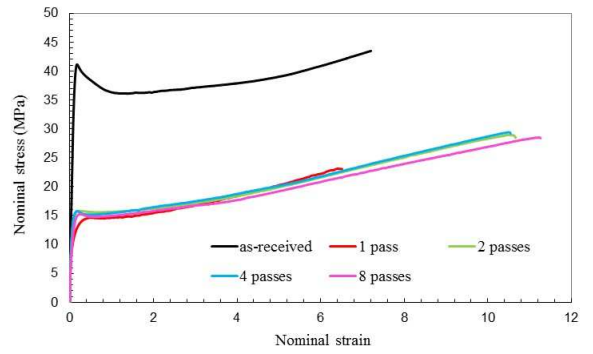

(d)

Figure 7. Stress-strain curves after extrusions: (a) route A and BP = 0, (b) route A and BP = 900N, (c) route C and BP = 0, (d) route C and BP = 900N.

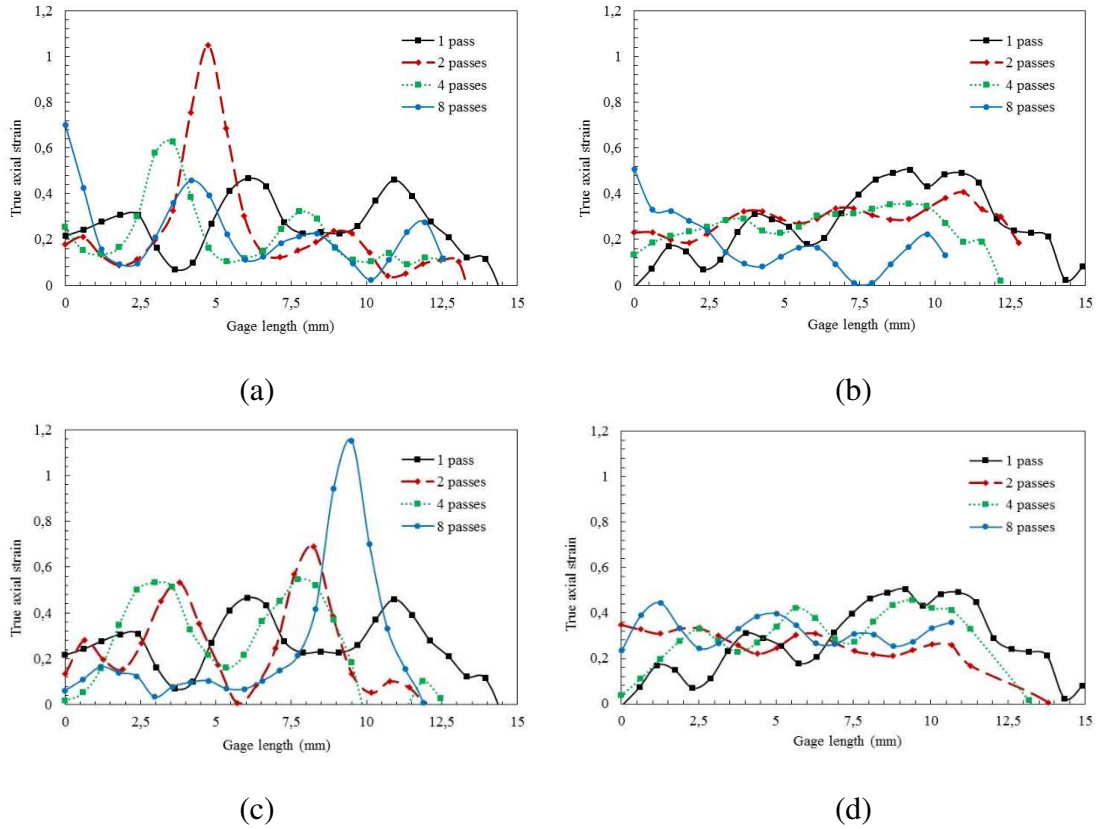
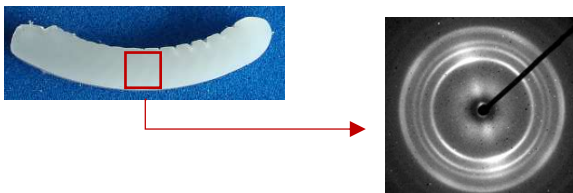
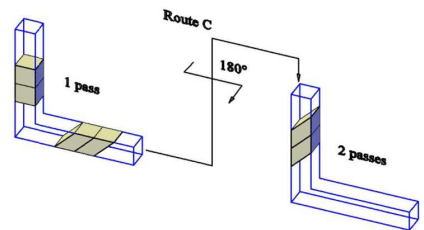
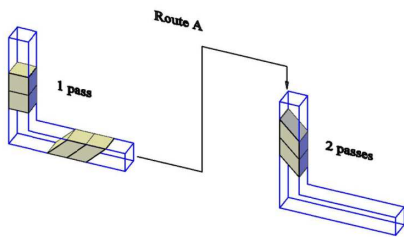
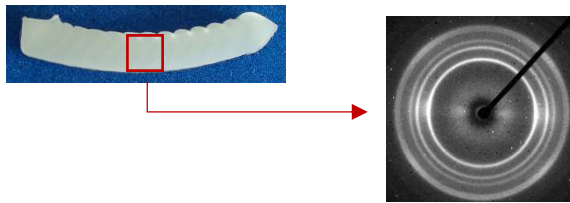
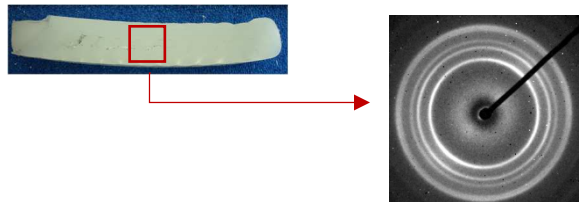

Figure 8. Strain profiles after extrusions along the gage length of the tensile specimen: (a) route A and BP = 0, (b) route A and BP = 900N, (c) route C and BP = 0, (d) route C and BP = 900N. The results are shown for an applied displacement of 5 mm.

1 pass



8 passes - route A



8 passes - route C