



HAL
open science

Development of a Bio-inspired Flexible Tail System

Benjamin Simon, Ryuki Sato, Jean-Yves Choley, Aiguo Ming

► **To cite this version:**

Benjamin Simon, Ryuki Sato, Jean-Yves Choley, Aiguo Ming. Development of a Bio-inspired Flexible Tail System. 12th France-Japan and 10th Europe-Asia Congress on Mechatronics, Sep 2018, Tsu, Japan. pp.230-235, <10.1109/MECATRONICS.2018.8495667>. <hal-03255668>

HAL Id: hal-03255668

<https://hal.science/hal-03255668v1>

Submitted on 15 May 2023

HAL is a multi-disciplinary open access archive for the deposit and dissemination of scientific research documents, whether they are published or not. The documents may come from teaching and research institutions in France or abroad, or from public or private research centers.

L'archive ouverte pluridisciplinaire HAL, est destinée au dépôt et à la diffusion de documents scientifiques de niveau recherche, publiés ou non, émanant des établissements d'enseignement et de recherche français ou étrangers, des laboratoires publics ou privés.



Distributed under a Creative Commons CC BY 4.0 - Attribution - International License

Development of a Bio-inspired Flexible Tail System

Benjamin Simon^{1,2}, Ryuki Sato¹, Jean-Yves Choley² and Aiguo Ming¹

¹The University of Electro-Communications,
Tokyo, Japan

{simon, sato_r}@rm.mce.uec.ac.jp, ming@mce.uec.ac.jp,

²The Higher Institute of Mechanics of Paris (SUPMECA),
Saint-Ouen, France

jean-yves.choley@supmecca.fr

Abstract—In the animal kingdom, many mammals are using their tails to assure their stability while running, jumping, falling, etc. Researches have been performed in order to add tails on wheeled or legged robots in order to improve their stability. However, those tails are often far from the biological structure and resumed to a simple rigid tube with a mass on the extremity. On the other hand the biological tail is composed of many bones moving one on the other and actuated with an important number of muscles. Therefore replicating this structure would result in big and heavy systems using many actuators that would reduce the physical performances of the robot. In this paper, we developed a new bio-inspired cable-driven tail system capable of swinging a flexible tail from base to tip around the pitching axis using a single actuator. First we designed a new flexible tail mimicking the structure of the animal tail. Then we developed a new actuation system using the combination of cams and drive wheels to realize the actuation of 8 cables using a single actuator. Finally, we measured the efforts generated by the swinging motion of the tail and perform experiments to observe its effects on the jumping motion.

Index Terms—Robot, Flexible tail, Bio-inspired, Cable-driven mechanism, Jumping.

I. INTRODUCTION

Animals are good sources of inspiration for mechanisms with their bodies built over years of evolution. They are capable of fast running and high jumping but over that they are capable of staying balanced during those performances. The source of their stability can often be found in the use of a tail to change the orientation of their body and stay balanced. For example, cheetahs use their tails to stay stable and perform quick turns while running at high speed, kangaroos use their tails as counterweight while hopping, lizards and cats use their tails to reposition their bodies to be in the optimal position for landing after a jump or a fall, the cats being also able to use their tails to stay balanced in case of lateral disturbances during the walk [1]–[4].

Some studies were therefore conducted to implement tail systems on robots and use their effects for stability or motion improvement [5]–[11]. However, the structures of the tails used in those studies usually consist in a simple rigid tube with a mass placed on its extremity and actuated on a single axis, either the pitching or the rolling axis. On the other hand, the biological tail is composed of many small vertebrae linked with ligaments and surrounded by many muscles and tendons resulting into a very flexible limb that can be moved in three dimensions [1] [12]–[14]. Using a rigid structure helps in simplifying the calculations but also generates less inertia than a multi-body structure would do with a decomposition of the

motion. Indeed, with the vertebrae sliding one on the other, the animal tail can generate a whip-like motion from the base to the tip to generate more inertia just like golfers or pitchers would decompose their motion from the torso to the hands to transfer the maximum of energy.

In our previous study [15], a flexible tail was built in order to improve our biped robot's jumping capacity using the advantage of its flexibility. This flexible tail was composed of multiple segments linked with tension springs and was actuated with a single DC motor placed on its base. Since only the first block of the tail was actuated, there were some delay between the rotation of the actuator and the end of the swinging motion of the tail due to the lack of active control of the deformation that also result in an important imbalance of the robot. To avoid this issue, common flexible tails mechanisms use cables to actively control the deformation of the structure [16] [17]. However, those cables are usually attached to the tip of the tail, which implies that the motion comes from the tip to the base. Therefore the tail would lose the advantage of the whip-like motion. To avoid that, additional cables can be attached to middle parts to decompose the tail in many sections and have a succession of bending motions going from base to tip. But increasing the number of cables also results in an increase of the number of actuators required thus an increase of the mass and the electric consumption that would reduce the performances of the robot on which the system is mounted.

In this study, we are aiming at the development of a new flexible tail system using a bio-inspired structure. This new system should be able to realize a bending of the tail from base to tip with an active control of the deformation while using the minimum of actuator possible. The system is designed to be mounted on the biped robot previously designed in our group [18]. This paper is organized as follow. The Section II details the design of the bio-inspired flexible tail. Section III describes the new actuation system for the tail. Section IV shows the efforts generated by the swinging of the tail and the use of the swinging motion for jumping.

II. THE FLEXIBLE TAIL

A. Design of the flexible tail

We decided to base the design of our flexible tail on the biological structure of the tails of kangaroos and cats. For these two animals, the structure of the tail is similar: a large number of vertebrae placed in series, connected to each other with ligaments and surrounded by several muscles that can

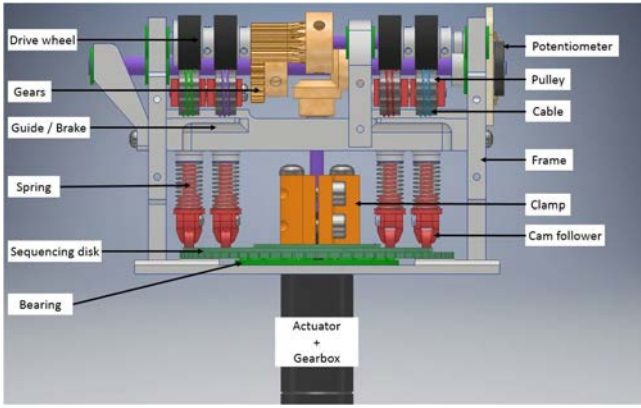

Fig. 3. 3D model of the actuation system.

where the cable is attached. With $l_0 = d = 52$ mm, $h = 13.5$ mm, to reach a deformation of $\phi = \pi/8$ for one section, 5.6 mm of cable need to be pulled and 5.3 mm need to be released on the opposite side. However because of the accordion shape, the shape of the bent tail is not a perfect circle arc and the length of cable that needed to be pulled when checking the deformation was 6.5 mm. This is the length that was used for the measurement of the tensions of the cables and the design of the actuation system. We used a force sensor placed on a linear guide to measure the pulling force that need to be applied on the cables to bend the sections of the tail. The required tensions are going from 5.8 N for the first section at the base to 3.6 N for the fourth section on the tip of the tail. We design the actuation system using the tension of the first cable for the four sections to keep a margin.

III. THE ACTUATION SYSTEM

The second step of this study consists in the designing of the actuation system for the tail. Usually, cable systems use three cables per section to control the deformation in three dimensions with one actuator for each cable [16] [17]. For our tail, since we are using 16 cables that would mean using 16 actuators for the 4 sections to have a deformation in three dimensions. Since we are using the cables in pairs we can reduce the number of actuator to 4 for the vertical motion and 4 for the horizontal motion. This represents an important addition of mass and an important electric consumption due to the fact that the motors need to stay turned on to prevent the release of the cables and keep the sections bent in the desired position. Therefore we had to find a solution to reduce the number of actuators required for the actuation of the tail.

A. Design of the tail's actuation system

The main difficulty comes from the sequence that we want to use for the bending of the tail. Indeed to bend the tail from the tip to the base is an easy task that can be realized with two cables attached to the tip of the tail. When pulling a cable, the section on the extremity would bend first until it reaches its maximum of deformation. Then the previous sections would bend, followed by the next one up to the first section at the

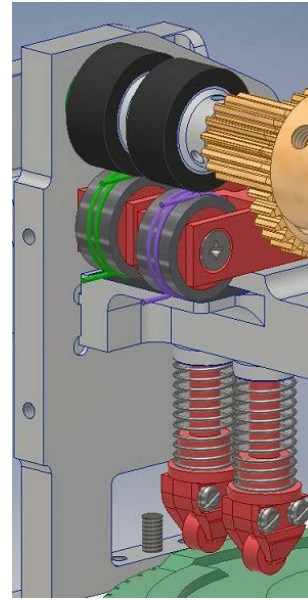

Fig. 4. Close look at the pulley - drive wheel system. The pulleys are placed between the the brake beneath it and the drive wheels above. The cables are rolled around the pulleys and fixed to it.

base. However, bending the tail from base to tip is a much more difficult challenge. When pulling the cable attached to the first section at the base, we also need to pull the cables of all the other sections in order to avoid the cables to be loosened with the compression of the first section. Therefore we need to be able to pull all the cables at once then, when the first section reaches its maximum of deformation, stop pulling the first cable while continuing to pull the others to continue the bending motion of the tail. Then stop pulling the second cable when its section reaches its maximum of deformation while continuing to pull the other, and repeat again the operation up to the tip. To have a smooth motion of the tail it is better not to stop the bending motion when we stop pulling a cable. Therefore, we need to be able to engage or disengage the motion of each individual pair of cable without stopping the complete system.

The transmission system that corresponds to this criteria is the drive wheel system. Using drive wheels, we can easily engage or disengage the motion by placing the wheels to actuate in contact with the drive wheels and use the friction for the transmission of the rotation. In our case, the wheels to actuate are the pulleys on which the cables are rolled on. As shown in Fig.3 we placed 4 drive wheels fixed on a single axis and placed the 4 pulleys beneath it. Using this system, we can easily engage or disengage the motion of the cables rolled on the pulleys by pressing the pulleys in contact with the drive wheels or placing the pulleys away from the drive wheels.

In order to move the pulleys to place them in contact with the drive wheels or place it in contact with the brake to prevent their rotation we are using a cam system. Using the rotation of the cam, the cam follower is moved from a down position

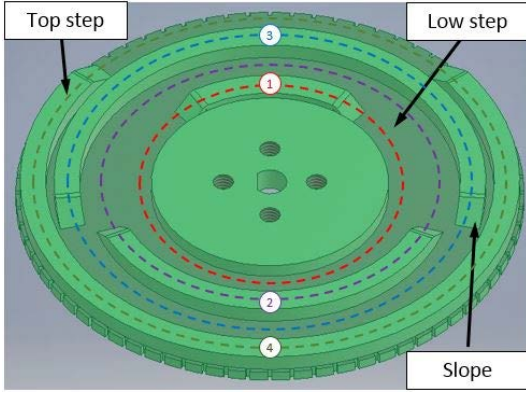

Fig. 5. 3D model of the sequencing disk with the 4 paths for the 4 sections.

to an up position that can correspond to our two states, active rotation of the pulley or locked rotation of the pulley. In order to avoid using two actuators for the rotation of the drive wheels axis and the rotation of the cams axis we synchronized the two using gears, allowing us to use the same initial rotation and therefore use a single actuator. However, we need the pulleys to stay in the active position during the motion of the cables. Therefore we cannot use simple eccentric cams since the up state is too short. Instead we decided to use centered cylinders with steps to move the cam-followers from a low step position to a top step position and keep a state during a desired period. Yet in order to stay in the up position during the required period for the pulling of the necessary length of cable for the bending of a section, we would need to have cams with diameters which we cannot afford due to the dimensions of our system. Therefore, to overcome this issue the 4 cams were combined into a single horizontal disk with steps on and called the sequencing disk. Using the rotation of the disk, the cam-followers are moved from the low step where the pulley is pressed against the brake using a spring to the top step with the required length where the pulleys are pressed against the drive wheels as shown in Fig.4.

Using this configuration a single actuator is required instead of two, one for the power transmission and one for the sequencing of the motion. First, the rotation of the actuator is transmitted to the sequencing disk in order to realize the sequencing of the deformation of the tail by moving the cam followers in the top steps in the desired order. Then using two gears stages, first with two bevel gears with a gear ratio of 1 then with two spur gears with a gear ratio of 2, the rotation of the sequencing disk axis is transmitted to the drive wheels axis. The drive wheels will then transmit the rotation to the pulleys using the pressure and friction between the two parts, the pulleys having a silicone surface and the drive wheels having a rubber surface. Moreover in order to prevent the slipping of the cables on the pulley due to the tension created by the bending of the tail the cables are attached to the pulleys. In addition, to prevent the slipping of the pulleys against the aluminum brake in the locked state, we placed a rubber band on the brake to increase the friction in addition to the pinching

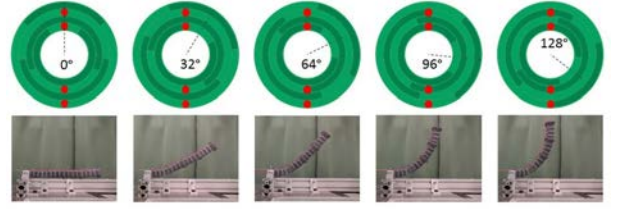

Fig. 6. Positions of the cam followers on the sequencing disk (in red) and the positions of the tail corresponding as the sequencing disk turns clockwise.

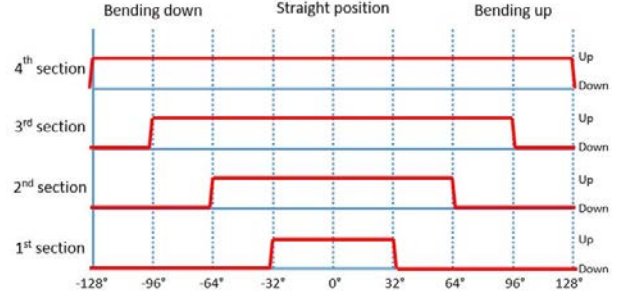

Fig. 7. Sequence of the bending of the tail from the first section to the fourth section with the position of the stems during the rotation of the sequencing disk from -128 to +128 degrees.

of the cables realized with the springs.

B. The sequencing disk

The sequencing disk (Fig.5) is the central part of this actuation system. Everything can be linked to the rotation of the sequencing disk. The bending of a section of the tail depends on the length of cable pulled which also corresponds of the length of the steps on the sequencing disk as shown in this equation

$$L = 2\pi R_d r_1 r_2 \frac{\theta_{step}}{360} \quad (3)$$

with L the length of cable pulled, R_d the radius of the drive wheel, r_1 and r_2 the gear ratio of the bevel gears and spur gears respectively, θ_{step} the length of the step in degree of rotation of the sequencing disk. Therefore, with the radius of the drive wheel fixed to 6 mm and the gears ratio fixed to 1 and 2 we need to have a 32 degree long step to pull the 6.5 mm of cables required for the complete bending of one section of the tail.

Since the position of the tail is decided by the bending of each section (i.e. the length of cable pulled for each section) we can also link the position of the tail to the angle of the sequencing disk, 0 being the straight position of the tail, +128 degrees the complete bending up of the tail and -128 degrees the complete bending down of the tail (Fig.6). The speed of the bending motion is also directly proportional to the speed of the sequencing disk rotation. Therefore to bend the tail in a desired position at a desired speed, we only need to input the angle of the sequencing disk and the rotational speed corresponding. More importantly, it is on this part that the sequence of the

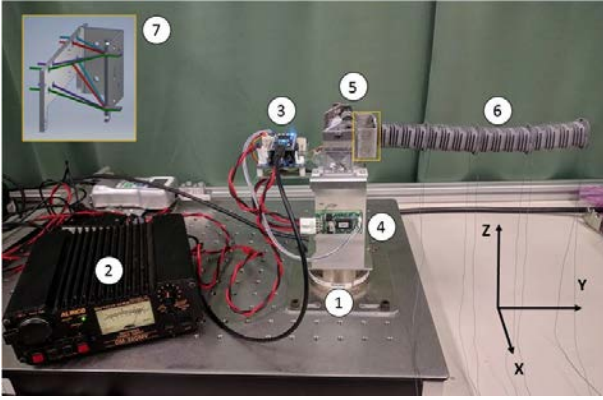

Fig. 8. Setup for the measurement of the generated efforts. 1: 6 axis force sensor. 2: Power source. 3: Mbed micro-controller. 4: Motor driver. 5: Actuation system. 6: Flexible tail. 7: Wires' guide from the actuation system to the tail.

TABLE I
BENDING PATTERNS

Patterns	Time (s)	Sequencing disk angle (degree)
Straight to Up (slow)	0.30	0 to 128
Straight to Up (fast)	0.15	0 to 128
Straight to Down	0.25	0 to -128
Straight to Down to Up	0.40	0 to -128 to 128
Down to Straight	0.15	-128 to 0
Down to Up	0.25	-128 to 128
Up to Straight	0.15	128 to 0
Up to Down	0.25	128 to -128

bending of the tail's sections is inputted. Due to the dimensions of the robot on which the system will be mounted, a maximum of 4 paths could be placed on the sequencing disk, thus the previous division of the tail into 4 sections. In order to realize the whip-like motion of the tail, the sequence placed on the sequencing disk corresponds to the bending of the sections of the tail from its base to the tip, from the straight position of the tail to its full bending up or down as illustrated in Fig.7. Indeed, moving the tail from tip to base would make it rolls on itself which has two undesired consequences: first the length of the tail is at its minimum when the first section is moved which generated lower inertia as it is linked to the length of the rotating object. Second, since the motion is going from tip to base, the first section is not moving in a first time which also reduce the generated inertia. In the other hand, if we move the tail from base to tip then when the first section moves, the tail is in the maximal extension and the full tail is moved. Then with the bending going from base to tip, the decreasing length of the part of the tail that is moved is compensated with an increasing bending speed.

IV. EXPERIMENTS

A. Measurement of the generated efforts

In order to measure the efforts generated by the swinging motion of the tail we placed the complete system on top of

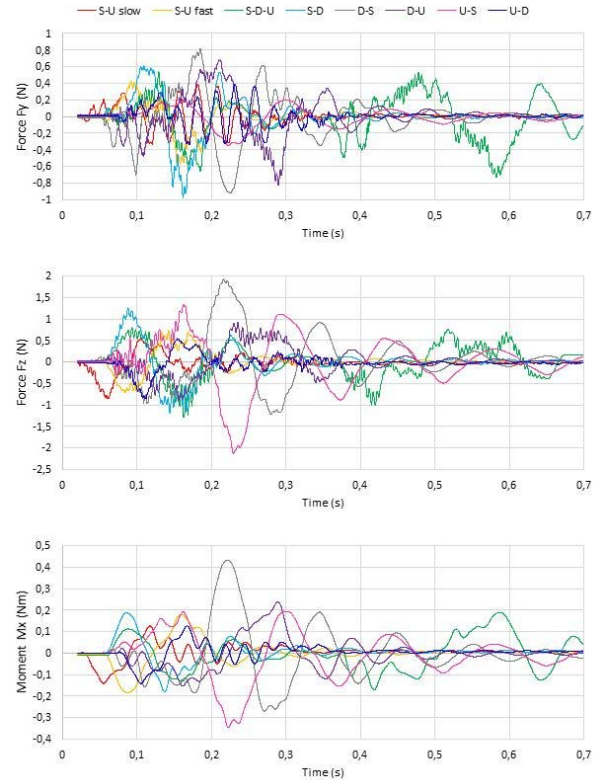

Fig. 9. Values of the measured efforts with D-Down position, S-Straight position, U-Up position, f-fast, s-slow. The graphs do not start at 0 due to the moving average filter.

a 6-axis force sensor, as shown in Fig.8. On the six efforts that we measured, the three that interested us are the force F_y that pulls the robot backward with the extension of the tail when it reaches the straight position or in the contrary push the robot forward at the end of the bending motion, the force F_z that pulls the robot up or pushes it down depending on the direction of the motion, and the momentum M_x created by those two forces and that acts on the pitching rotation of the robot.

Those efforts were measured for different bending patterns of the tail that are listed in Table-I. The results of the measurement are shown in Fig.9. The two patterns that generates the maximum of efforts are the extension of the tail from the bent down position to the straight position and from the bent up position to the straight position. This can be explained by the increased of the length of the distance from the base of the tail to its center of mass, thus generating more inertia as well with the fact that the straight position is the rest position of the tail.

B. Jumping experiment

The developed tail system was mounted on the biped robot as shown in Fig.10. Since the addition of the tail system must not have an important negative impact on the robot's jumping capacity we performed a jumping experiment to measure the impact of the new tail system on the robot. We performed

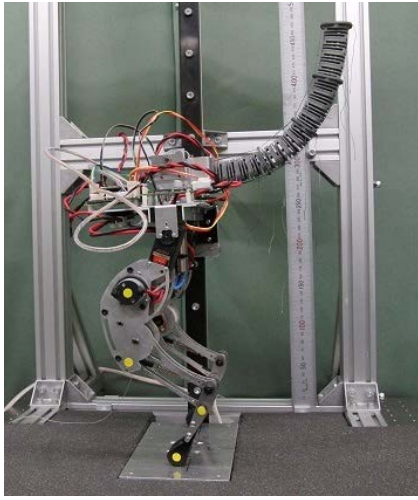

Fig. 10. The biped robot with the tail system mounted on.

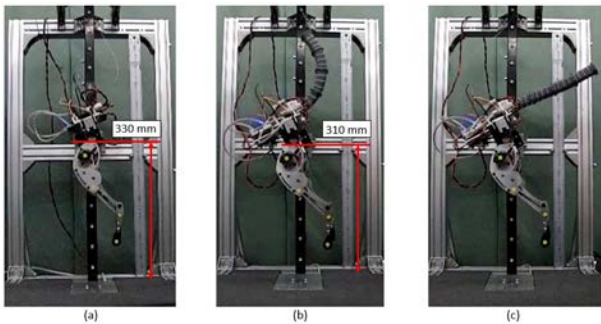

Fig. 11. Comparison on the maximum high reached (a) without the tail system, (b) with the bending of the tail, (c) without the bending of the tail.

several jumps with different patterns to use the previously measure force F_z to help to compensate the mass of the actuation system. Using the flexible tail during the jumps, the robot could reach a maximum height of 310 mm at the hip joint which is inferior to the 330 mm reachable without the tail system, see Fig.11. Moreover, the same maximum height was reached without actuating the tail. The flexible tail is too light to have a real impact on the robot's jump height and cannot help compensating the addition of the actuation system to the robot.

V. CONCLUSION

In this paper we presented our new tail system composed of a bio-inspired flexible tail and its actuation system capable of moving 4 pairs of cables according to a desired sequence using a single actuator with the use of the combination of drive wheels and a cam system. With this actuation system, a single sequence can be placed on the sequencing disk at a time but it is enough for our desired use of the system as a simple swinging tail. However the mass of the tail system would need to be further reduced to improve the effect of the tail of the robot.

The next step of this research will be to use the tail system for the stabilization of the robot in case of perturbations not predicted by the motion planning. The tail will then be used for the static stabilization with the displacement of the center of mass of the system as well as the dynamic stabilization of the robot using the generated momentum. Afterwards, the use of a second actuation system would allow the tail to have a deformation in the horizontal plane.

REFERENCES

- [1] R. Dawson, N. Milne, and N. M. Warburton, "Muscular Anatomy of The Tail of the Western Grey Kangaroo, *Macropus Fuliginosus*," *Australian journal of zoology*, vol.62 issue 2, pp.166–174, 2014.
- [2] A. Jusufi, D. I. Goldman, S. Revzen, and R. J. Full, "Active Tails Enhance Arboreal Acrobatics in Geckos," *Proceedings of the National Academy of Sciences*, vol.105 issue 1, pp.4215–4219, 2008.
- [3] G. B. Gillis, L. A. Bonvini, and D. J. Irschick, "Losing Stability: Tail Loss and Jumping in the Arboreal Lizard *Anolis Carolinensis*," *Journal of Experimental Biology*, vol. 212 issue 5, pp.604–609, 2009.
- [4] G. H. Liu, H. Y. Lin, H. Y. Lin, S. T. Chen, and P. C. Lin, "A Bio-Inspired Hopping Kangaroo Robot with an Active Tail," *Journal of Bionic Engineering*, vol.11 issue 4, pp. 541–555, 2014.
- [5] R. Briggs, J. Lee, M. Haberland, and S. Kim, "Tails in Biomimetic Design: Analysis, Simulation, and Experiment," *Proceedings of IEEE/RSJ International Conference on Intelligent Robots and Systems (IROS)*, pp. 1473–1480, 2012.
- [6] A. Patel, "Understanding the Motions of the Cheetah Tail Using Robotics," *Diss. University of Cape Town*, 2015.
- [7] A. M. Johnson, T. Libby, E. Chang-Siu, M. Tomizuka, R. J. Full, and D. E. Koditschek, "Tail assisted dynamic self righting," *Adaptive Mobile Robotics*, pp. 611–620, 2012.
- [8] A. De, and D. E. Koditschek, "Parallel Composition of Templates for Tail-Energized Planar Hopping," *Proceedings of IEEE International Conference on Robotics and Automation (ICRA)*, pp. 4562–4569, 2015.
- [9] R. E. Fisher, L. A. Geiger, L. K. Stroik, et al., "A Histological Comparison of the Original and Regenerated Tail in the Green Anole, *Anolis Carolinensis*," *The Anatomical Record*, vol.295 issue 10, pp.1609–1619, 2012.
- [10] T. B. Ritzman, L. K. Stroik, E. Julik, et al., "The Gross Anatomy of the Original and Regenerated Tail in the Green Anole, *Anolis Carolinensis*," *The Anatomical Record*, vol.295 issue 10, pp.1596–1608, 2012.
- [11] N. Wada, A. Nakata, T. Koga, and M. Tokuriki, "Anatomical Structure and Action of the Tail Muscles in the Cat," *Journal of Veterinary Medical Science*, vol.56 issue 6, pp. 1107–1112, 1994.
- [12] C. Walker, C. J. Vierck Jr, and L. A. Ritz, "Balance in the Cat: Role of the Tail and Effects of Sacrocaudal Transection," *Behavioural brain research*, vol.91 issue 1-2, pp. 41–47, 1998.
- [13] G. J. Zeglin, "Uniroo—A One Legged Dynamic Hopping Robot," *Diss. Massachusetts Institute of Technology*, 1991.
- [14] E. Chang-Siu, T. Libby, M. Tomizuka, and R. J. Full, "A Lizard-Inspired Active Tail Enables Rapid Maneuvers and Dynamic Stabilization in a Terrestrial Robot," *Proceedings of IEEE/RSJ International Conference on Intelligent Robots and Systems (IROS)*, pp. 1887–1894, 2011.
- [15] R. Sato, S. Hashimoto, A. Ming and M. Shimojo, "Development of a Flexible Tail for Legged Robot," *Proceedings of IEEE International Conference on Robotics and Automation (ICRA)*, pp. 683–688, 2016.
- [16] W. S. Rone, and P. Ben-Tzvi, "Static Modeling of a Multi-Segment Serpentine Robotic Tail," *In ASME 2015 International Design Engineering Technical Conferences and Computers and Information in Engineering Conference*, American Society of Mechanical Engineers, pp. V05AT08A054, 2015.
- [17] W. S. Rone, and P. Ben-Tzvi, "Continuum Robotic Tail Loading Analysis for Mobile Robot Stabilization and Maneuvering," *In ASME 2014 International Design Engineering Technical Conferences and Computers and Information in Engineering Conference*, American Society of Mechanical Engineers, pp. V05AT08A009, 2014.
- [18] A. Ming, K. Sato, R. Sato, E. Kazama, I. Miyamoto and M. Shimojo, "Development of Robot Leg Composed of Parallel Linkage and Elastic Spring for Dynamic Locomotion," *Proceedings of IEEE International Conference on Information and Automation (ICIA)*, pp.38–43, 2015.