

A level-set framework for the wind turbine wake analysis

F. Houtin-Mongrolle¹, P. Benard¹, G. Lartigue¹, V. Moureau¹

¹ Normandie Univ, INSA Rouen, UNIROUEN, CNRS, CORIA, Rouen
76000, France



Context: Wind turbines wakes

- Optimize windfarm productions [1]:
 - Global control strategies : understand the wind turbine wake behaviour
 - 3D effect are not negligible (yaw, tilt, atmospheric effects)

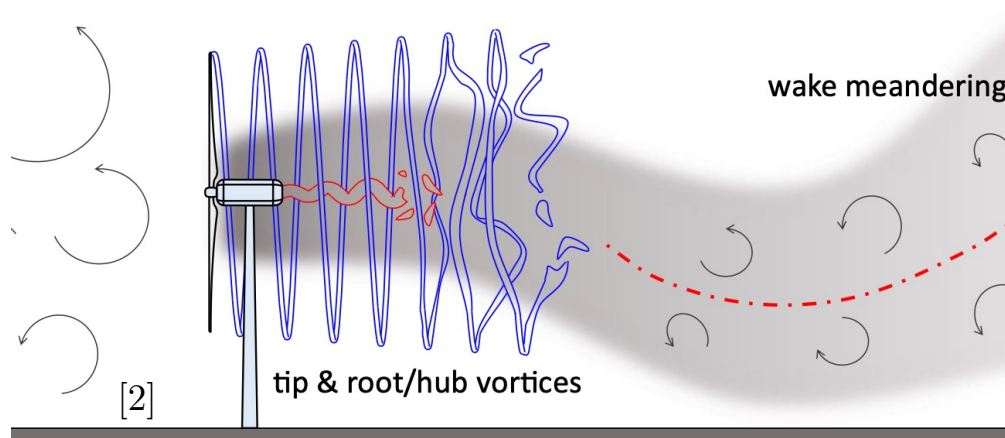

- Upstream turbulence [2]:
 - Turbine Loads
 - Wake meandering/recovery
- Yawed wind turbine [3]:
 - Wake deflection
 - Turbine loads

Methodology to investigate complex wake behaviour: yawed wind turbine, upstream turbulence
→ Quantitative on the various regions in the near to far wake

[1] Gebraad P M O, Teeuwisse F W, van Wingerden J W, Fleming P A, Ruben S D, Marden J R and Pao L Y 2016 Wind Energy 19 95–114
[2] Porté-Agel, F, Bastankhah, M and Shamsoddin, S 2020 Boundary-Layer Meteorology 174, 1–59
[3] Bastankhah M and Porté-Agel F 2016 Journal of Fluid Mechanics 806 506–541

Context: Wake modelling

- Field measurement of offshore turbines ($\sim 150\text{m}$) are not achievable yet[1].
Need to capture the wake instabilities, vortices interactions and quantify the energy fluxes
→ Request of a numerical framework

	Spatial scale (m)	Velocity scale (m/s)	Reynolds number	Time scale (s)
Blade Boundary layer	1.10^{-3}	0 – 100	$\sim 10^3$	1.10^{-5}
Blade profile	1	0 – 100	$\sim 10^6$	1.10^{-2}
Rotor	1.10^2	10	$\sim 10^8$	10
Windfarm	$1.10^3 - 1.10^4$	10	$\sim 10^8$	$1.10^2 - 1.10^3$

→ Main wake simulation challenges: Large range of spatial and time scales

- High fidelity Large Eddy Simulation [2-3]:
 - Capture the wide range of scale dynamics → Reliable flow diagnostics
 - Blade resolved computation unaffordable → Actuator Line Method

High fidelity LES with ALM requests a fine resolution over a large computational domain:

→ How to perform quantitative analysis ?

[1] Breton S P, Sumner J, Sørensen J N, Hansen K S, Sarmast S and Ivanell S 2016 Mathematical, Physical and Engineering Sciences 375 20160097
 [2] Sørensen J and Shen W 2002 J Fluids Eng 124 393–9
 [3] L. A. Martínez-Tossas et. al. (2015), . Wind Energy

Define the wake bounding (Streamtubes)

- Classical 1D momentum theory [1] is based on streamtube control volumes:
 - Three states considered: upstream, downstream and turbine position

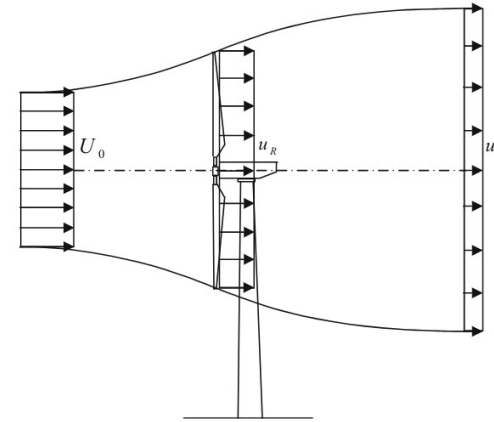

→ Replicate 1D momentum theory based on integrals over the turbine streamtube

- Use of Accurate Conservative Level Set function [2,3] to track the streamtube interface:

$$\psi(\mathbf{x}, t) = \frac{1}{2} \left(\tanh \left(\frac{\phi(\mathbf{x}, t)}{2\varepsilon} \right) + 1 \right)$$

After the function initialisation, 2 steps:

$$\frac{\partial \psi}{\partial \tau} + \frac{\partial \psi \langle \tilde{u}_i \rangle}{\partial x_i} = 0$$

Advection

$$\frac{\partial \psi}{\partial \tau} = \nabla \cdot (\varepsilon (\nabla \psi \cdot \mathbf{n}) \mathbf{n} - \psi (1 - \psi) \mathbf{n})$$

Reinitialization

- Low diffusion error
- Not requiring reconstruction (i.e. not limited by the streamtube curvature)
- Differ from lagrangian particles injection, requiring reconstruction [3,4]

[1] Sørensen J N 2016 The general momentum theory vol 4 (Springer)

[2] Janodet R, Guillaumon C, Moureau V, Mercier R, Lartigue G, Benard P, Ménard T and Berlemont A 2020

[3] Meyers J and Meneveau C 2013 Journal of Fluid Mechanics 715 335–58

[4] West J R and Lele S K 2020 Energies 13 1–25

Define the wake bounding (Streamtubes)

- Use of Accurate Conservative Level Set function to track the streamtube interface:

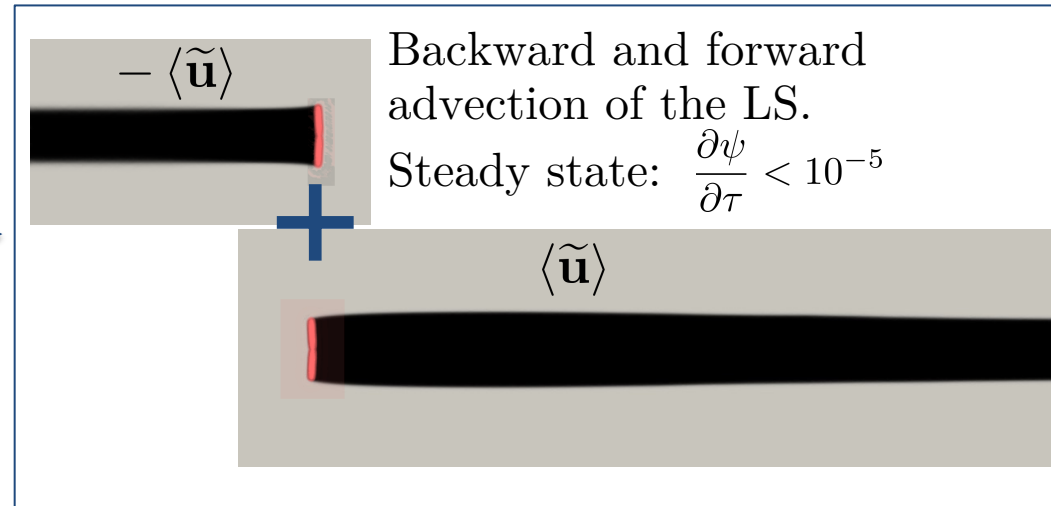
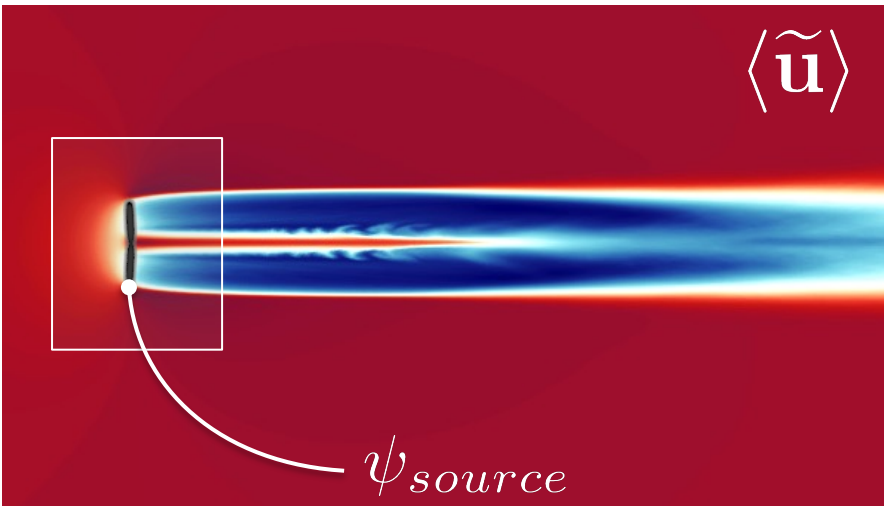

With a closed control volume this allow to average data and reduce the amount of information (selective sampling: integrate/filtering)

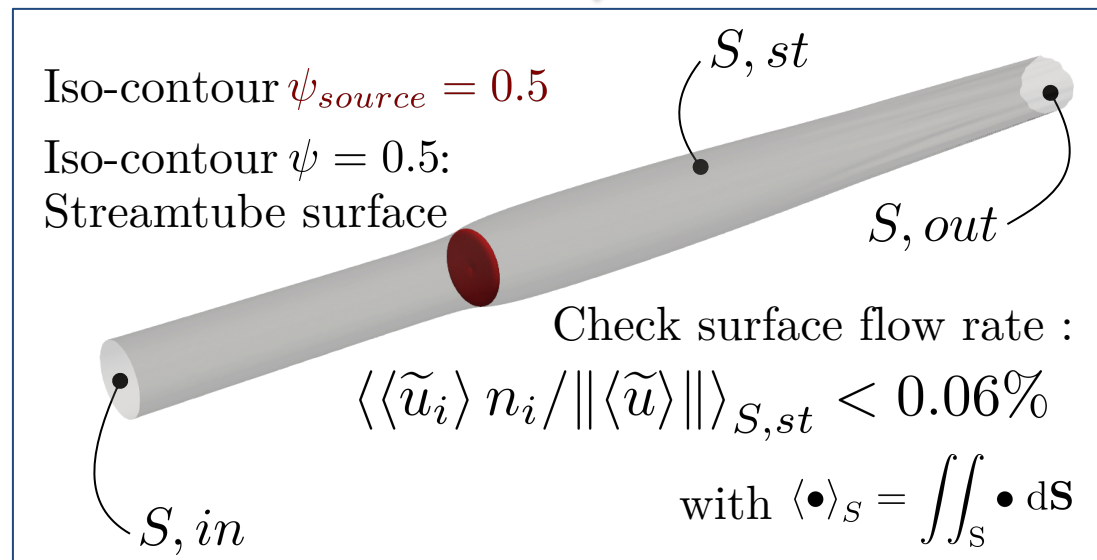

YALES2 flow solver

- Developed at CORIA and distributed in the SUCCESS scientific group [1,2]
- Features:
 - **Unstructured meshes** (complex geometries) and **adaptive grid refinement**
 - **Low Mach number Navier Stokes equations** (incompressible and variable density) solved with a projection method
 - Double domain decomposition [2]
 - **Interface tracking functions** (ACLS) for two-phase flows [3]
 - Highly efficient solvers for linear system inversion (PCG, DPCG)
 - **4th order** central finite volume method and **4th order** time integration
 - **Actuator Line Method** [4]
 - **Suited for massively parallel computing** (>32 000 procs)

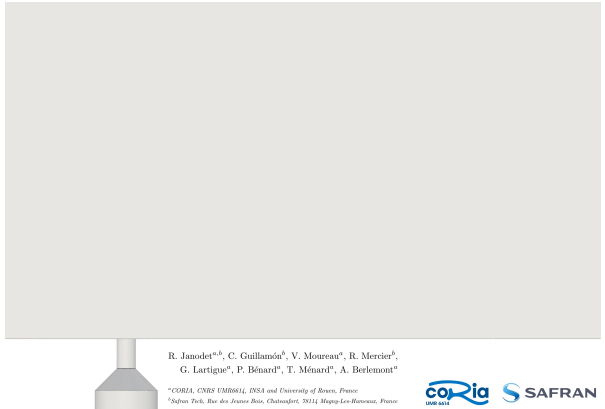
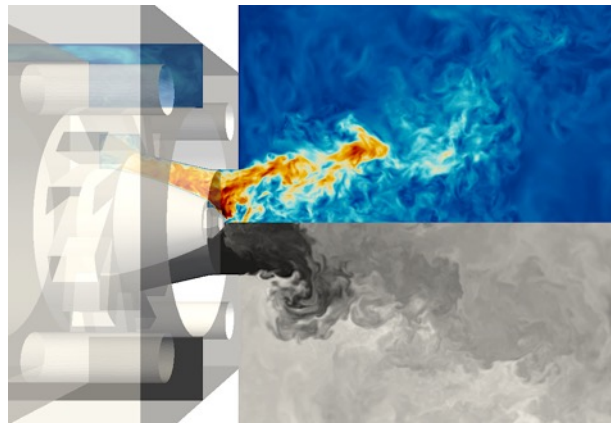
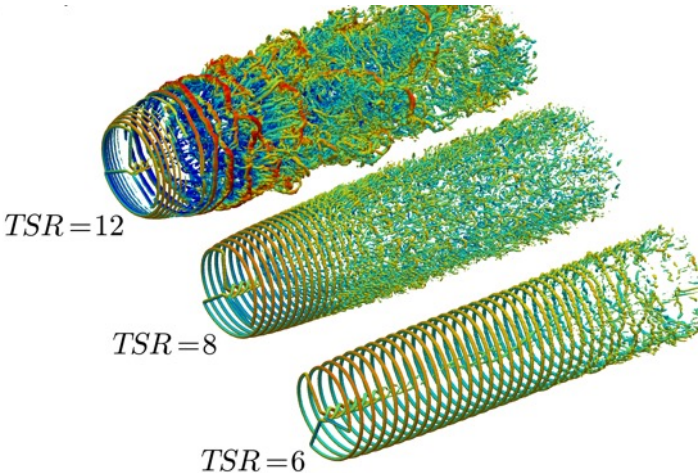

[1] YALES2 web site, <http://www.coria-cfd.fr>

[2] Moureau et. al., CR Mecanique, 2011

[3] Janodet R, Guillaumon C, Moureau V, Mercier R, Lartigue G, Benard P, Menard T and Berlemont A 2020

[4] Houtin-Mongrolle F, Benard P, Moureau V, Lartigue G, Bricteux L and Reveillon J 2020 J. Phys.: Conf. Ser. **1618** 062064

Application to DTU10MW wind turbine

- Investigate the wake of offshore wind turbine [1]:

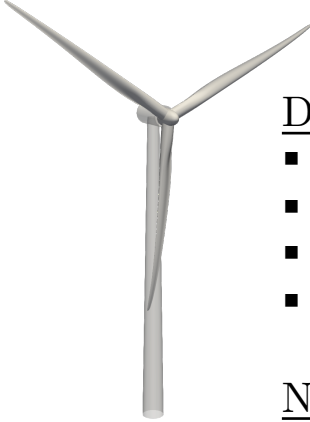

DTU10MW [1]:

- Diameter = 178.3m
- Pitch angle = 0°
- TSR = 7.5
- Yaw angle, $\gamma = 0^\circ, 30^\circ$

Numerical properties:

- Actuator elements: 75/blade
- $\varepsilon/\Delta x = 2$ [2]
- No corrections
- Isotropic gaussian kernel

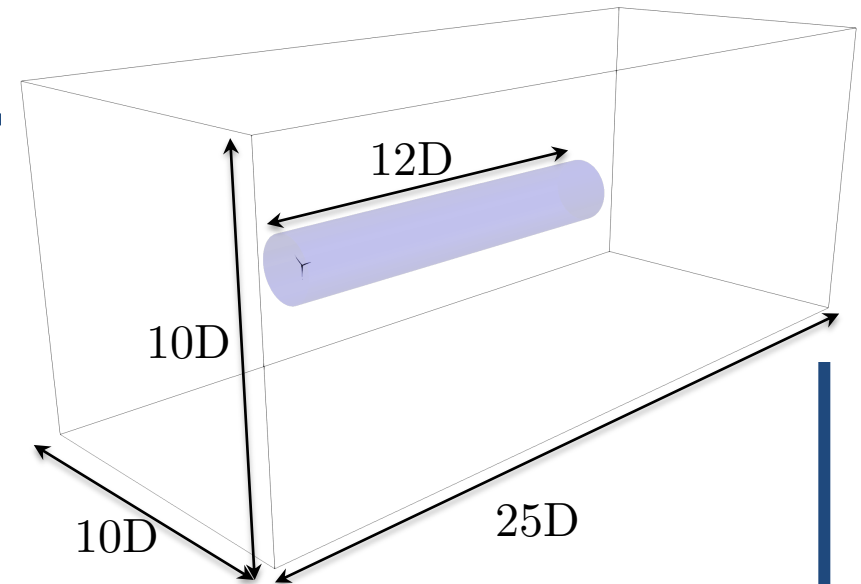

Computational domain:

- Investigate the wake up to 12D (2.2km)
- 10Dx10Dx25D, no confinement effects
- Target wake cell size: $0.007 \Delta x/D$

Inflows:

- Laminar 10m/s
- Mann synthetic turbulence [3] 10m/s
 $TI_{2D, upstream} = 14\%$

High fidelity simulations:
2 yaw angles and 2 inflows.

LY0

LY30

TY30

TY0

Request a mesh refined in the proper area
→ How to generate a large mesh size
based on the wake characteristics

[1] Bak C, Zahle F, Bitsche R, Kim T, Yde A, Henriksen L C, Natarajan A and Hansen M 2013 DTU 10MW Ref WT Tech. rep. DTU Wind Energy
[2] L. A. Martínez-Tossas et. al. (2015), . Wind Energy
[3] Mann J 1998 Probabilistic Engineering Mechanics 13 269–82

High fidelity simulation mesh strategy

- Estimation of a streamtube surrounding the turbine:
 - Precursor simulations on coarse mesh
 - Computation of a wide streamtube
- Cell size is imposed in the streamtube (-2D → 12D)
- Smooth Coarsening up to the inlet → Turbulent cases

Computational resources:
8448 cores/cases
400 GB/cases

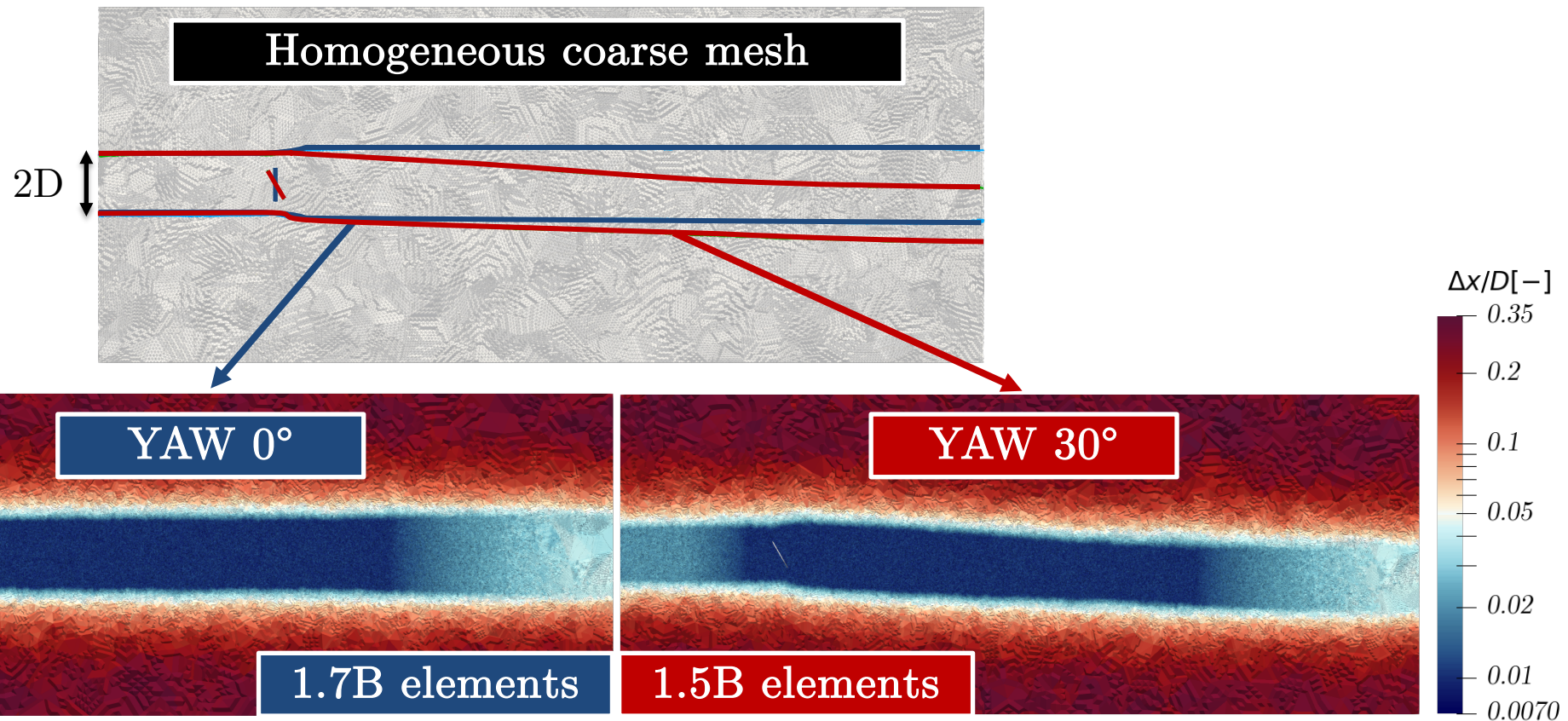

Wake visualisation

$t = 0.00$ s Slice of the instantaneous streamwise velocity field for all cases

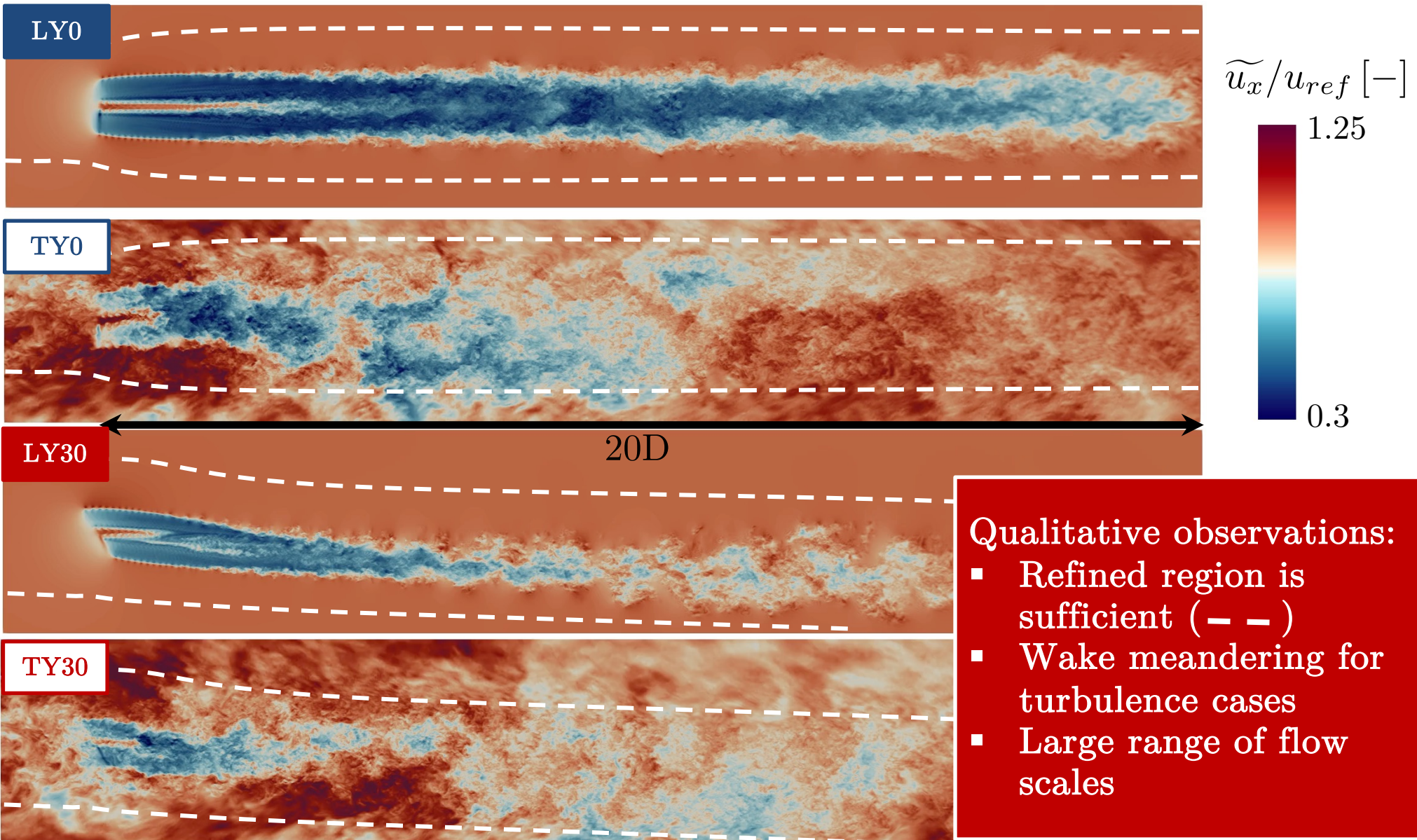

Wake visualization

Evolution of $Q_{\text{criterion}}$ contour colored by streamwise velocity

$$\widetilde{u}_x / u_{\text{ref}} [-]$$



$t = 0.00 \text{ s}$

10.0 D

LY0

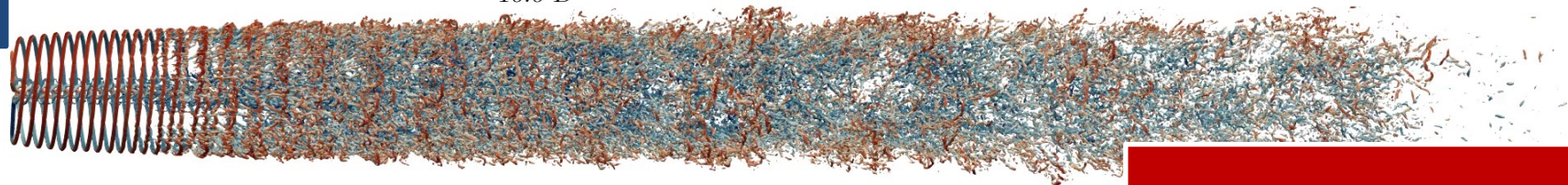

TY0

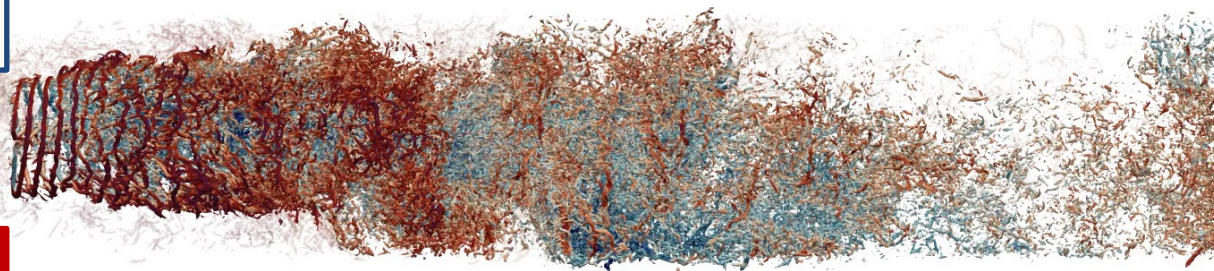

LY30

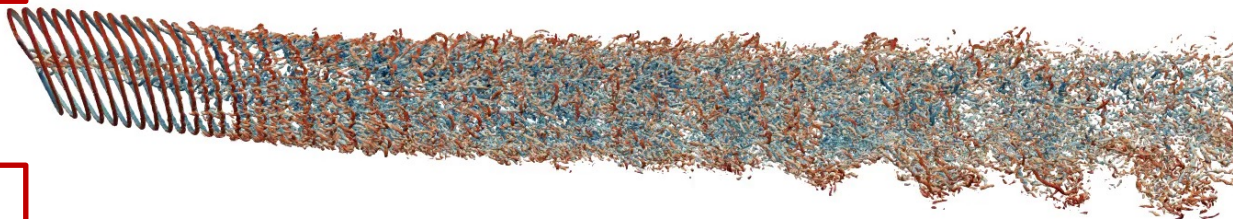

TY30

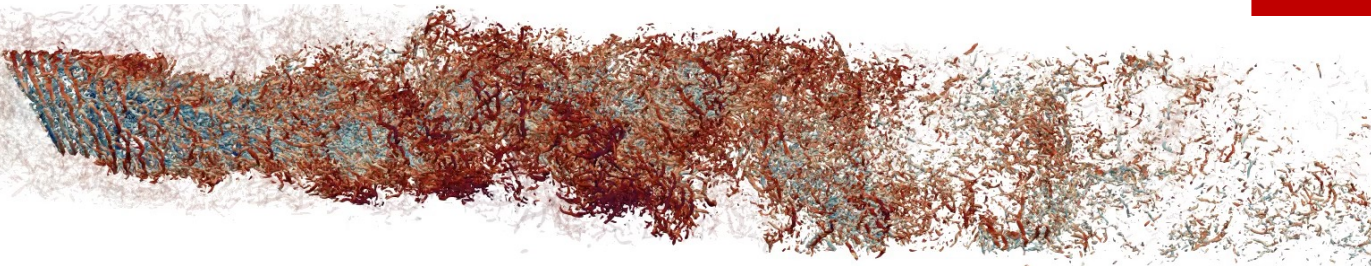

Complex vortex dynamic :

- Pairing
- Interactions with external turbulence
- Vortices intensity decay in the “far wake”

→ Different regions can be suggested along the wake

Wake visualization, time averaged data

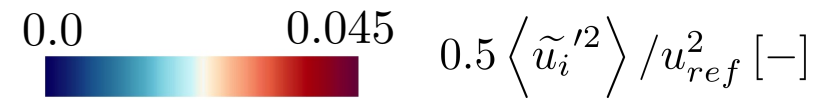

LY0

TY0

LY30

TY30

Accumulation time:
 $100D / u_{ref} = 1783s$

Upstream turbulence:
→ Wake recover faster
→ Triggers the TKE generation in the wake
Yawed wind turbine:
→ Streamtube deflection

Budgets on streamtube

- Mean Kinetic Energy budget (MKE):

$$\iint_S \left(\underbrace{\frac{1}{2} \rho \langle \tilde{u}_i \rangle \langle \tilde{u}_i \rangle \langle \tilde{u}_j \rangle}_i + \underbrace{\langle \tilde{u}_j \rangle \langle \tilde{P} \rangle}_{ii} + \underbrace{\langle \tilde{u}_i \rangle \rho \langle \tilde{u}'_i \tilde{u}'_j \rangle}_{iii} + A_{j,S} \right) n_j dS$$

i: Change in MKE (S)

ii: Pressure work (S)

iii: Work of the Reynolds stress (S)

iv: TKE production (V)

v: Turbine work (V)

$$- \iiint_{V_{st}} \left(\underbrace{\rho \langle \tilde{S}_{ij} \rangle \langle \tilde{u}'_i \tilde{u}'_j \rangle}_{iv} + \underbrace{\rho \langle \tilde{u}_i \rangle \langle \tilde{f}_i \rangle}_v + A_V \right) dV = 0$$

- Mean Momentum budget horizontal component (MM_y):

$$\iint_S \left(\underbrace{\langle \tilde{u}_y \rangle \langle \tilde{u}_j \rangle n_j}_i + \underbrace{\frac{1}{\rho} \langle \tilde{P} \rangle n_y}_{ii} + \underbrace{\langle \tilde{u}'_y \tilde{u}'_j \rangle n_j}_{iii} + A_y \right) dS - \iiint_{V_{st}} \underbrace{\langle \tilde{f}_y \rangle}_{iv} dV = 0$$

i: Change in Momentum (S)

ii: Pressure forces (S)

iii: Forces of the Reynolds stress (S)

iv: Turbine forces (V)

Viscous and subgrid scale terms are negligible.
→ Yet included in the Residual (MKE and MM)

→ Streamtubes are decomposed in 150 cross-sections where Mean Momentum and Mean Kinetic Energy Budgets are integrated

$N = 150$

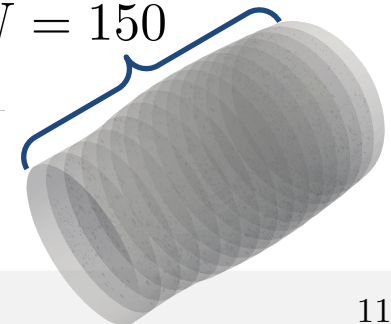

Wake recovery: MKE budget

Four regions highlighted:

- Region I: Tip vortices advection
- Region II: Tip vortices pairing
- Region III: Velocity deficit recovers
- Region IV: Turbulence decays

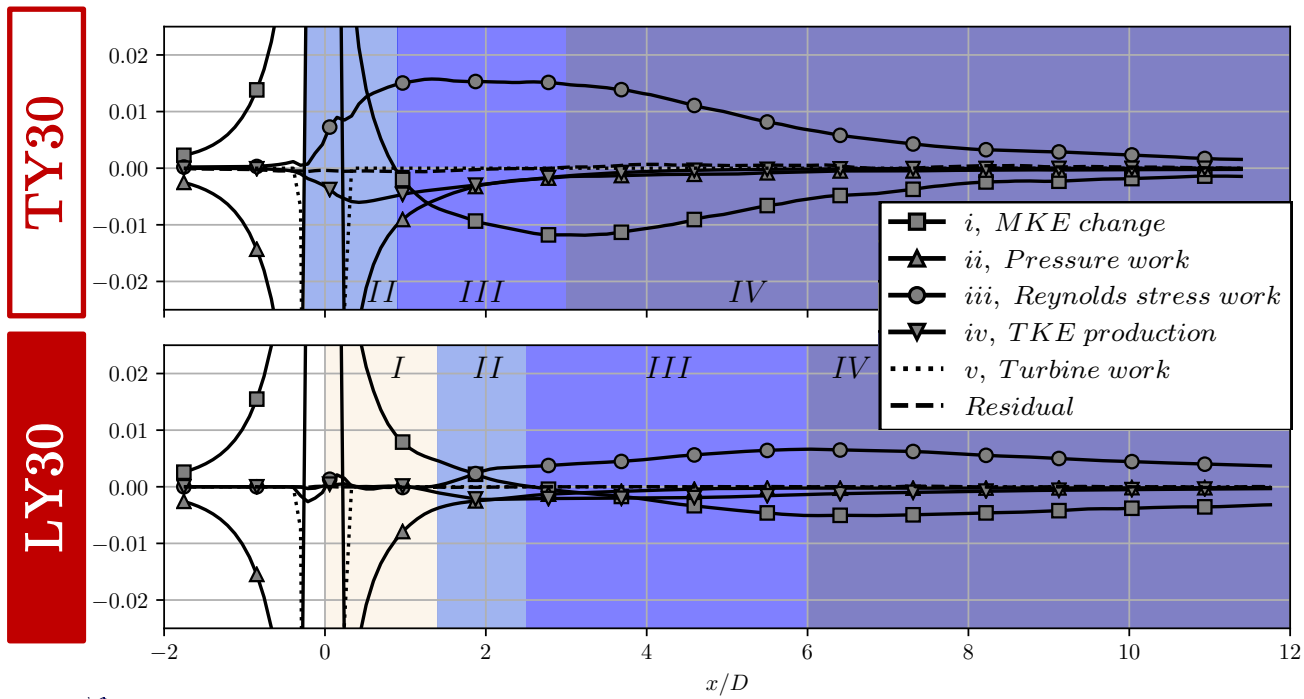

TY30

LY30

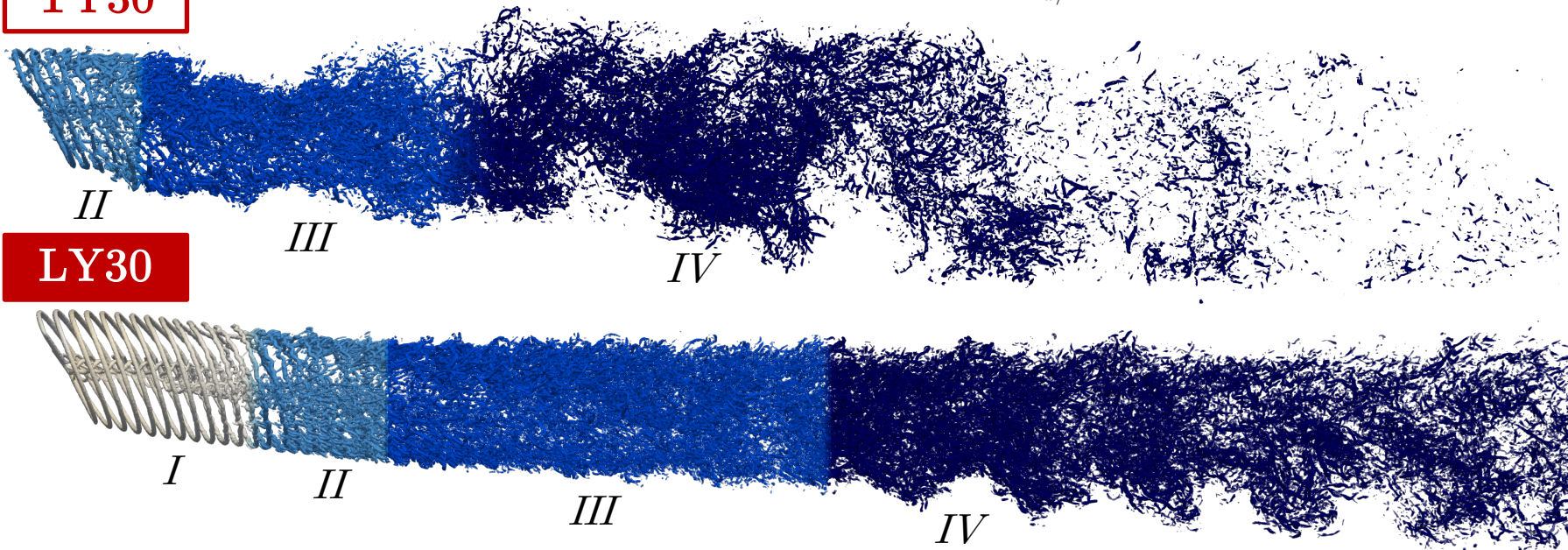

Wake recovery: integrated quantities

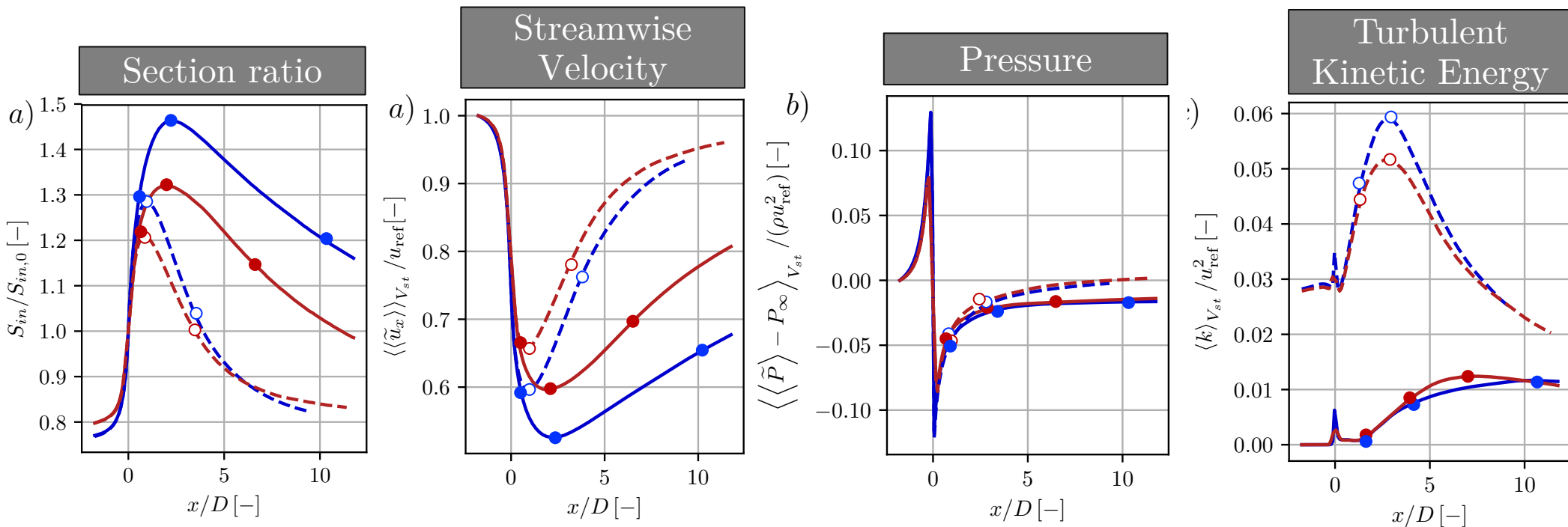

Similar trends for all cases :

- I: Section ↗↗, Velocity ↘↘, pressure drop, TKE peak
- II: Section ↗, Velocity ↘, TKE ↗↗
- III: Section ↘↘, Velocity ↗↗, TKE ↗
- IV: Section ↘, Velocity ↗, TKE ↘

LY0	LY30
TY0	TY30

Yaw angle:
 0° 30°
 Inflow:
 — Laminar - - - Turbulent

→ 4 regions are highlighted in the wake
 Yawed wind turbine induces lower velocity deficit → Lower Thrust coefficient
 Upstream turbulence triggers the wake recovery

Wake deflection: $MM_{horizontal}$ Budget

Region I: Turbine Force

→ Horizontal momentum flux ↘

Region II: Reynolds stress

→ Horizontal momentum flux ↗

Region III: Pressure forces

→ Horizontal momentum flux $\sim cst$

Region IV: All terms $\rightarrow 0$

Wake deflection \rightarrow constant
(driven by the external flow)

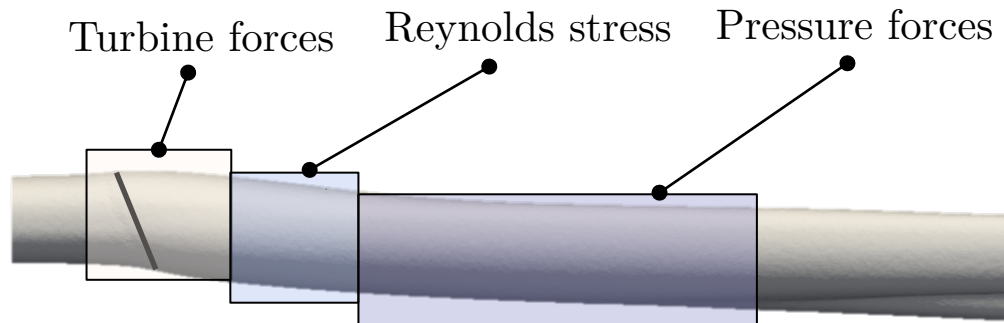
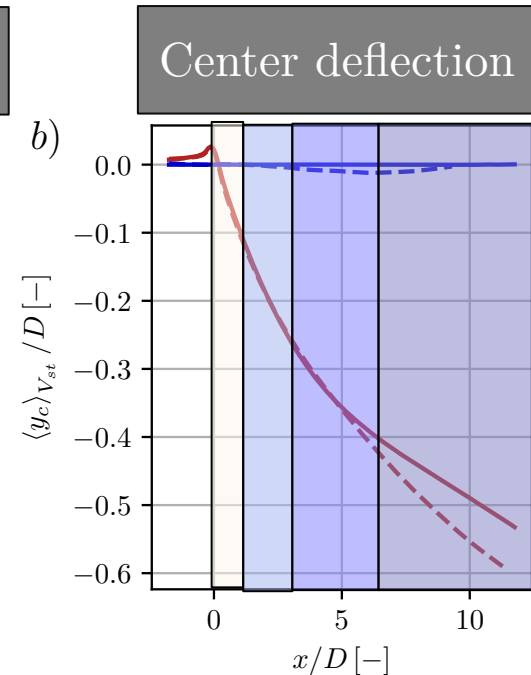
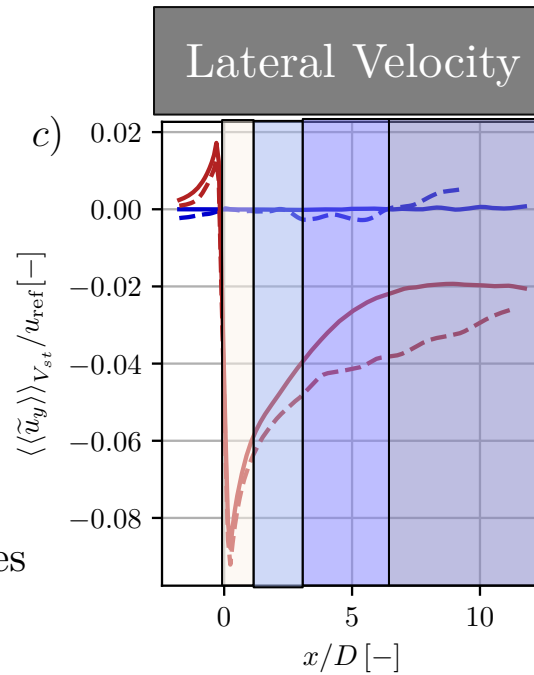
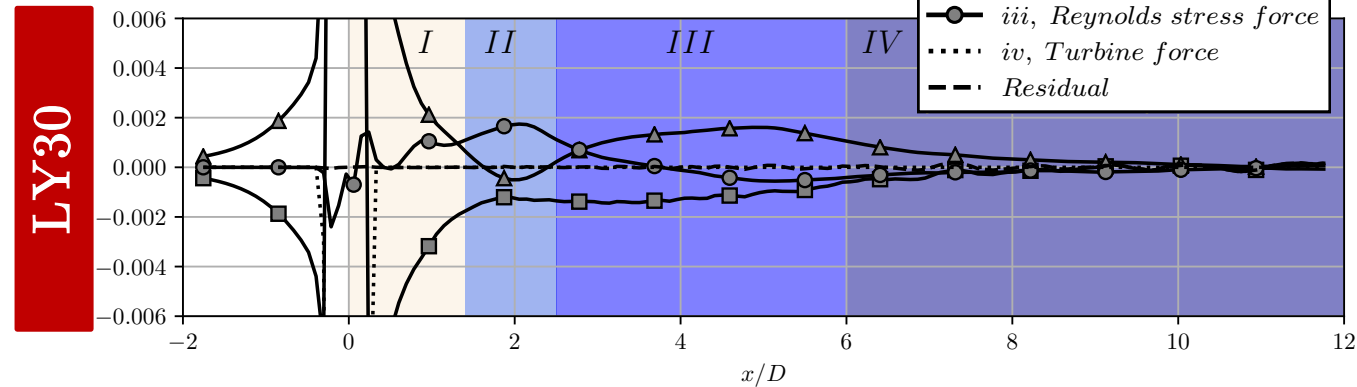

LY0	LY30
TY0	TY30

Yaw angle:
0° 30°

Inflow:
— Laminar - - - Turbulent

Conclusion and further work

Four high fidelity Large Eddy Simulations LY0 LY30 TY30 TY0

- Upstream turbulence impact:
 - 4 regions are identified from the terms contributing to MKE
- Yawed wind turbine wake deflection:

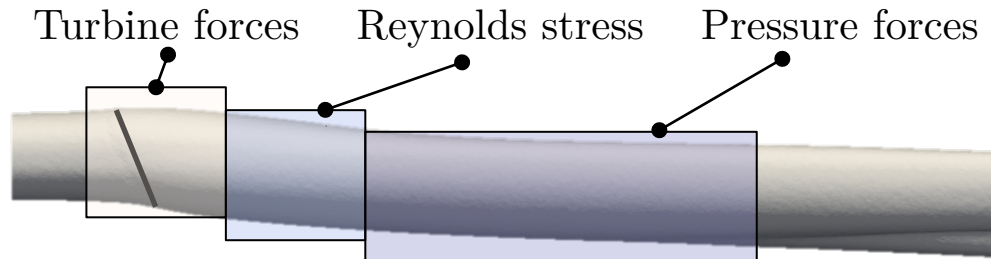

→ Reliable tools for case comparison including complex 3D effects on high fidelity numerical simulations

- Further work:
 - Use this framework to compare higher complexity cases:
 - ABL effects, tower/nacelle effects, blade deformation effect on wake
 - Take into account unsteadiness of the wake: Meandering
 - Use of ACLS to follow fluids particles passing through the rotor in order to evaluate the mixing layer width

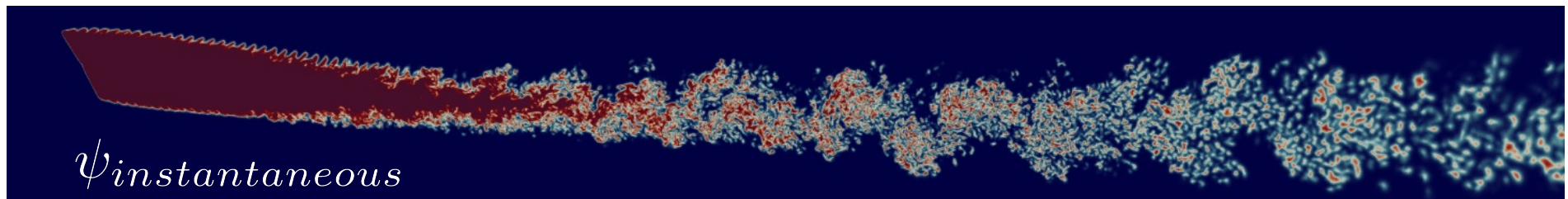

Acknowledgment

We acknowledge PRACE for awarding us access to Joliot-Curie at GENCI@CEA, France.



WIMPY project

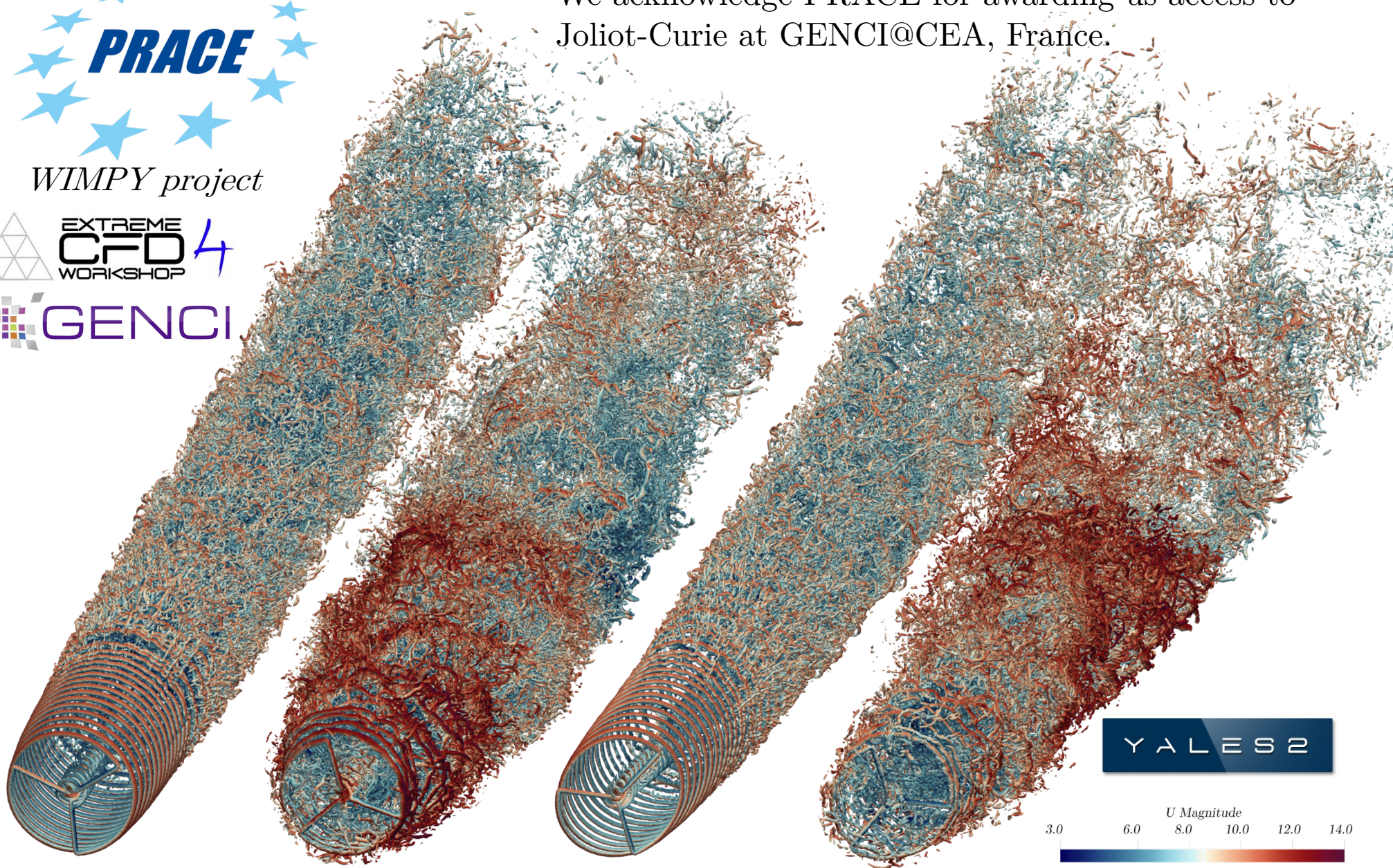

Y A L E S 2

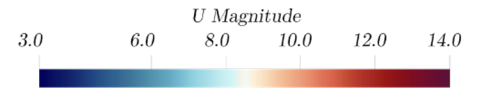

Performances

- Turbine performances:

Case	γ	inflow	# elements	$\langle C_P \rangle \pm C_P'$	$\langle C_T \rangle \pm C_T'$
LY0	0°	uniform	1.9×10^9	0.466 ± 0.003	0.772 ± 0.002
LY30	$+30^\circ$	uniform	1.7×10^9	0.366 ± 0.006	0.606 ± 0.003
TY0	0°	$TI_{-2D} = 14\%$	1.9×10^9	0.49 ± 0.09	0.78 ± 0.07
TY30	$+30^\circ$	$TI_{-2D} = 14\%$	1.7×10^9	0.39 ± 0.08	0.62 ± 0.06

Table 1. Cases and mesh properties. Reference values for a laminar inflow are $\langle C_P \rangle = 0.476$ and $\langle C_T \rangle = 0.814$ [14].

- Computational cost:

Time averaging over 1783s:

- Wall clock time $\sim 72\text{h}/\text{case}$
- Processors 8448/case
- CPUkh $\sim 1\,000/\text{case}$

Compute Streamtube:

- Wall clock time $\sim 15\text{h}/\text{case}$
- Processors 8448/case
- CPUkh $\sim 130/\text{case}$

MKE all cases

