



**HAL**  
open science

## **Energy Harvesting using loaded Metamaterial Absorber. Unit-cell with polarization independent Capability**

Said Choukri, Hakim Takhedmit, Otman El Mrabet, Laurent Cirio

### ► **To cite this version:**

Said Choukri, Hakim Takhedmit, Otman El Mrabet, Laurent Cirio. Energy Harvesting using loaded Metamaterial Absorber. Unit-cell with polarization independent Capability. 10th National Days on Energy Harvesting and Storage (JNRSE) 2021, Jun 2021, Grenoble, France. hal-03243881

**HAL Id: hal-03243881**

**<https://hal.science/hal-03243881>**

Submitted on 31 May 2021

**HAL** is a multi-disciplinary open access archive for the deposit and dissemination of scientific research documents, whether they are published or not. The documents may come from teaching and research institutions in France or abroad, or from public or private research centers.

L'archive ouverte pluridisciplinaire **HAL**, est destinée au dépôt et à la diffusion de documents scientifiques de niveau recherche, publiés ou non, émanant des établissements d'enseignement et de recherche français ou étrangers, des laboratoires publics ou privés.



## ABSTRACT

In this paper, we demonstrate the feasibility of harvesting electromagnetic waves by using a metamaterial absorber unit-cell with a high absorption rate of 98.86 %, that operates at 5.8 GHz. The numerical results show that the proposed unit-cell has nearly constant performances regardless the polarization angle of the incoming waves. Then four resistive loads were embedded in the unit-cell to compute the radiation to RF conversion efficiency. An equivalent circuit model was also proposed and comparison was made to the simulation results.

## UNIT-CELL DESIGN

The following figure shows the geometry of the proposed unit-cell :

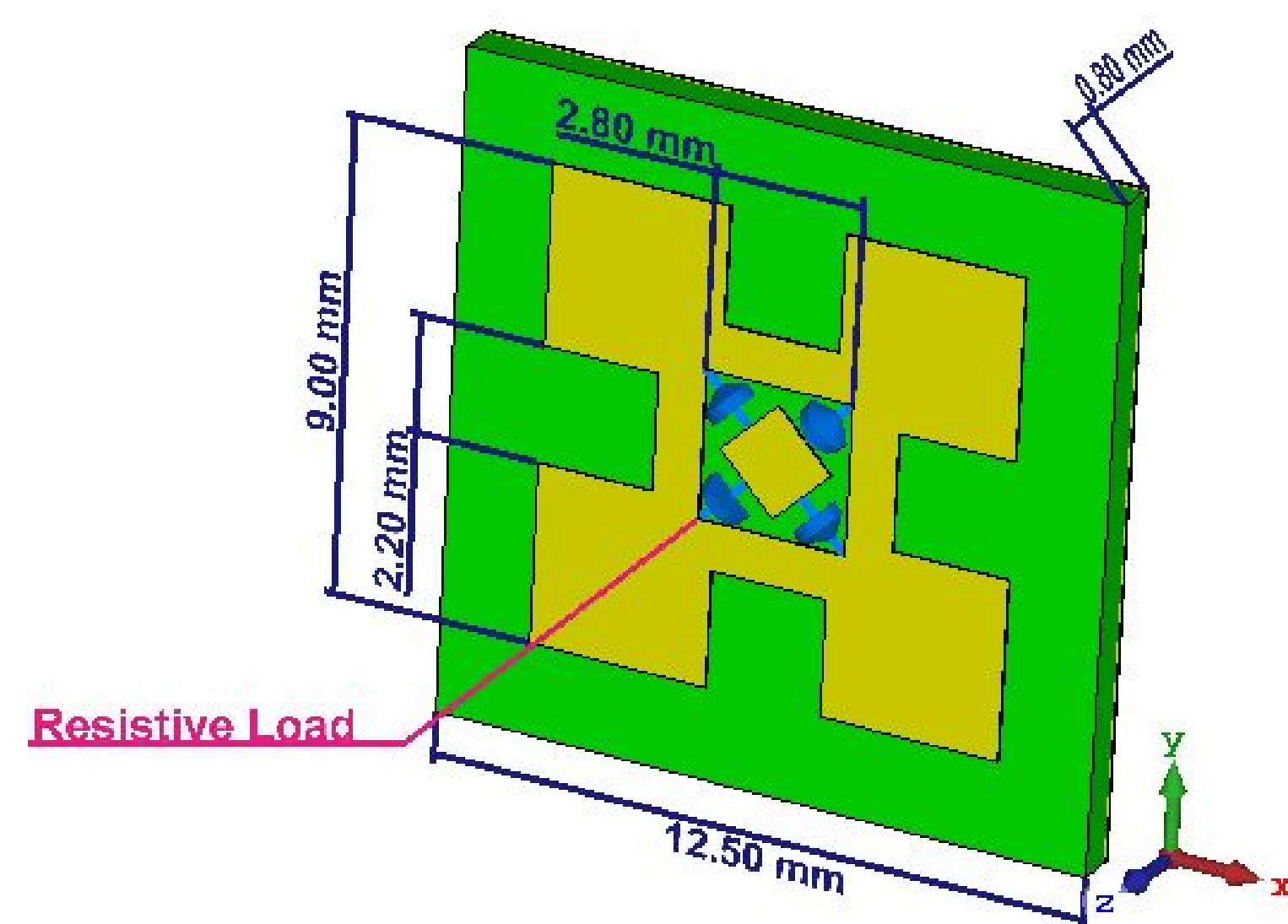

Figure 1: Unit-Cell Geometry

The unit-cell was designed on FR4 Substrate ( $\epsilon_r=4.3$ ,  $\tan \delta=0.025$ ), and backed with a copper ground Plan.

An equivalent circuit model for the whole structure was derived as shown in Fig.2.

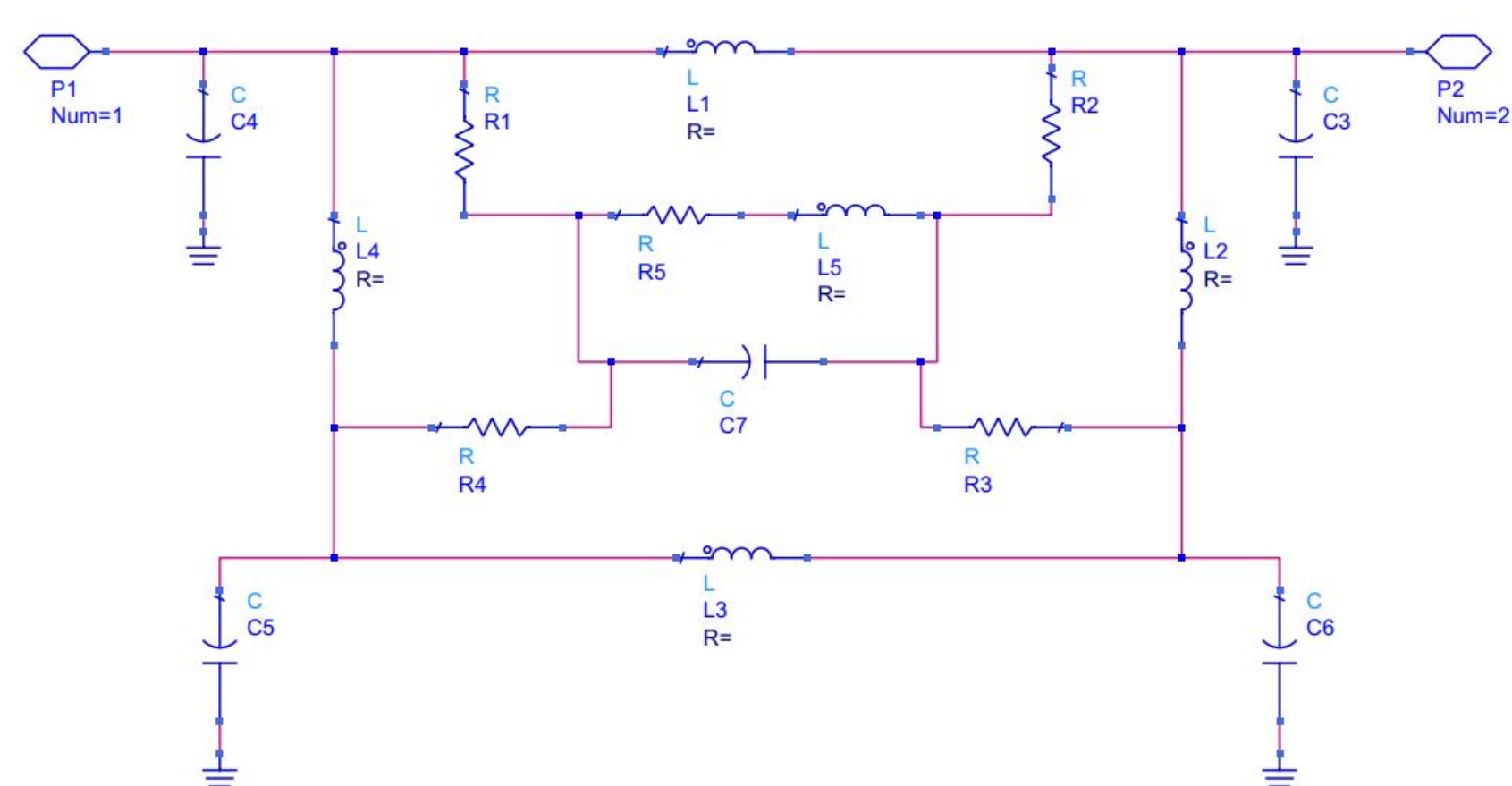

Figure 2: Circuit Model

## REFERENCES

- [1] Qiong He et al. Tunable/reconfigurable metasurfaces: Physics and applications. *Research*, 2019.
- [2] Maged A. et al Aldhaeabi. Highly efficient planar metasurface rectenna. *IEEE Access*, 8, 2020.

## INTRODUCTION

Nowadays, the demand for energy autonomy for portable systems becomes more and more substantial particularly in 5G communication technology, Radio Frequency Identification (RFID), electric vehicles, Internet of Things (IoT) and Wireless Sensor Nodes (WSN).

With conventional microstrip antennas we still have some limitations like:

- low RF-to-AC conversion efficiency,
- polarization mismatch,
- narrow beam-width etc..

## CURRENT DISTRIBUTIONS

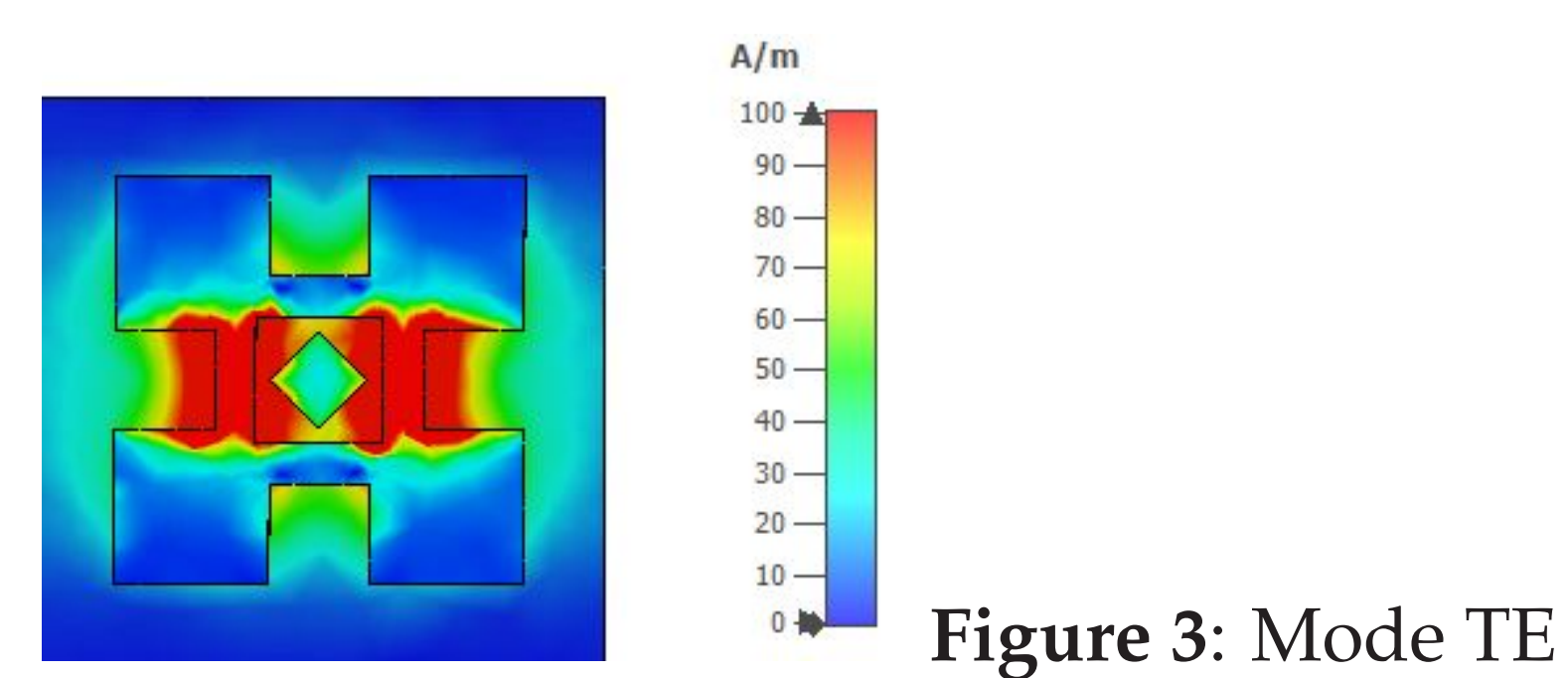

Figure 3: Mode TE

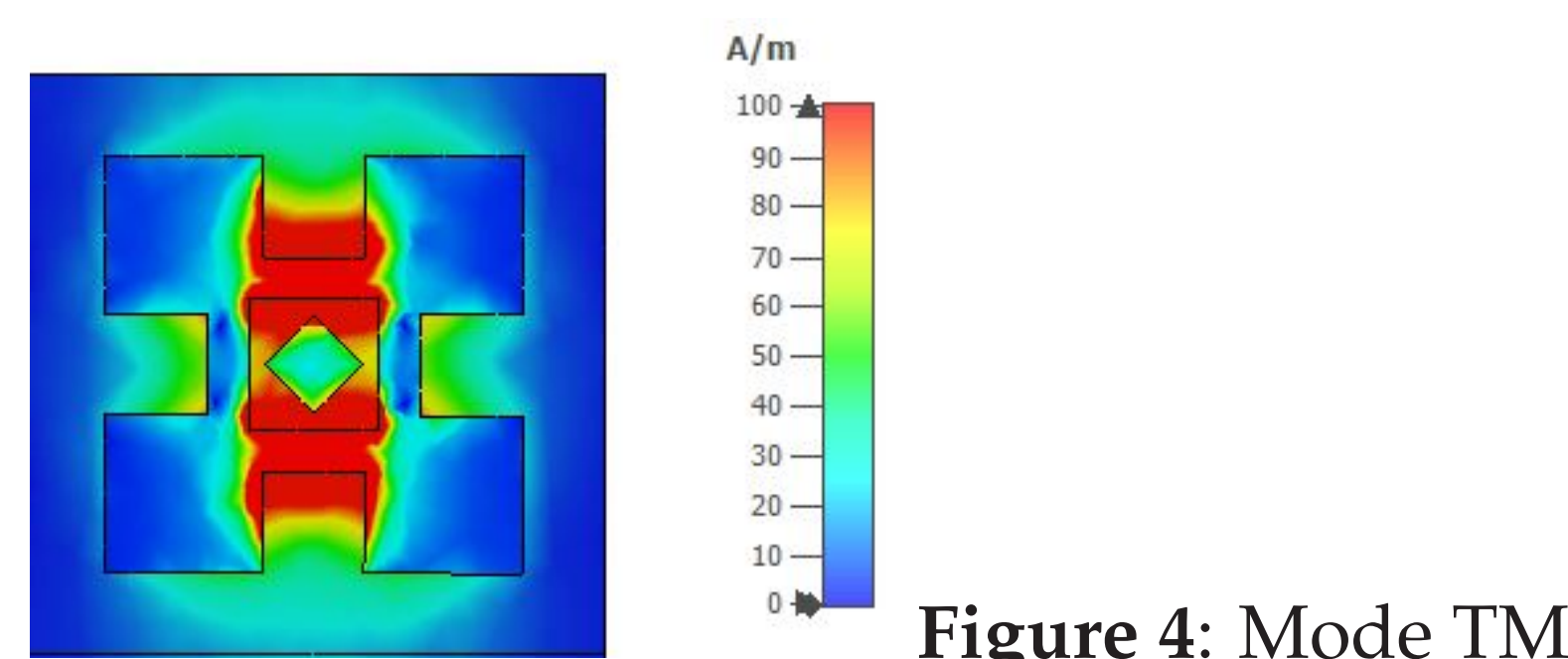

Figure 4: Mode TM

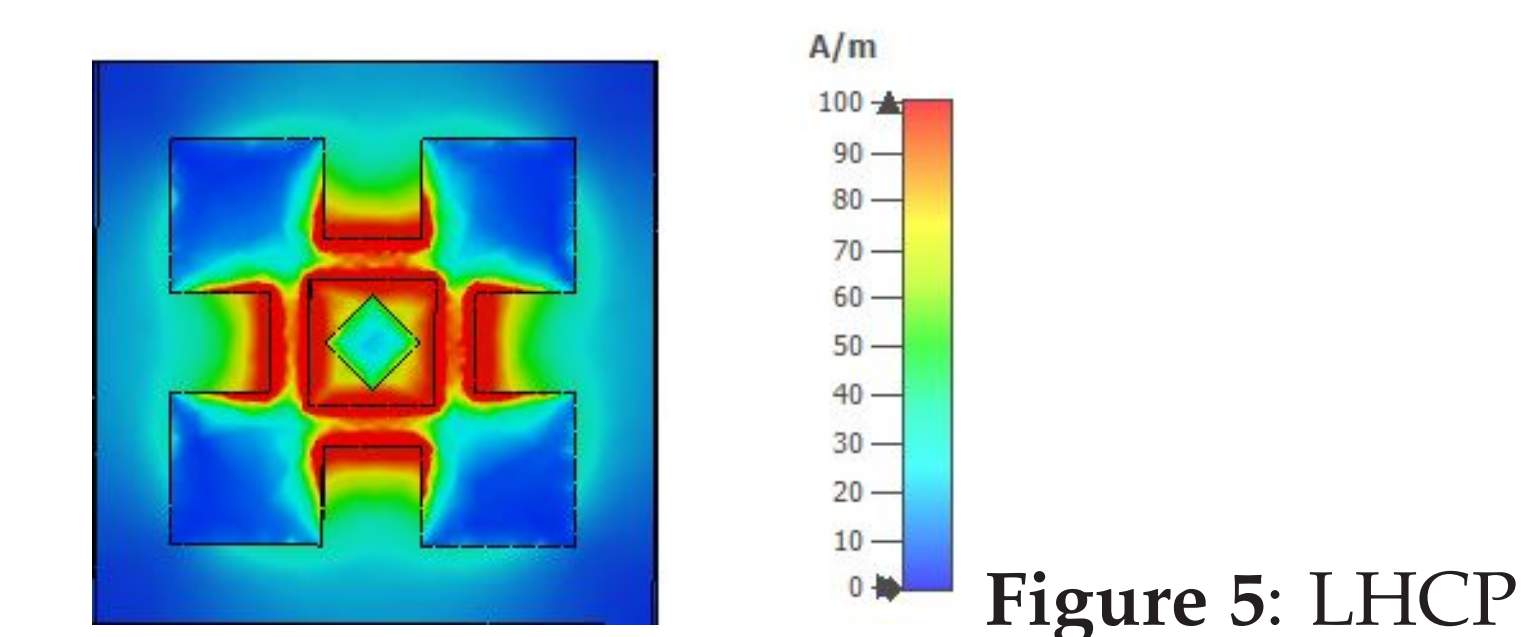

Figure 5: LHCP

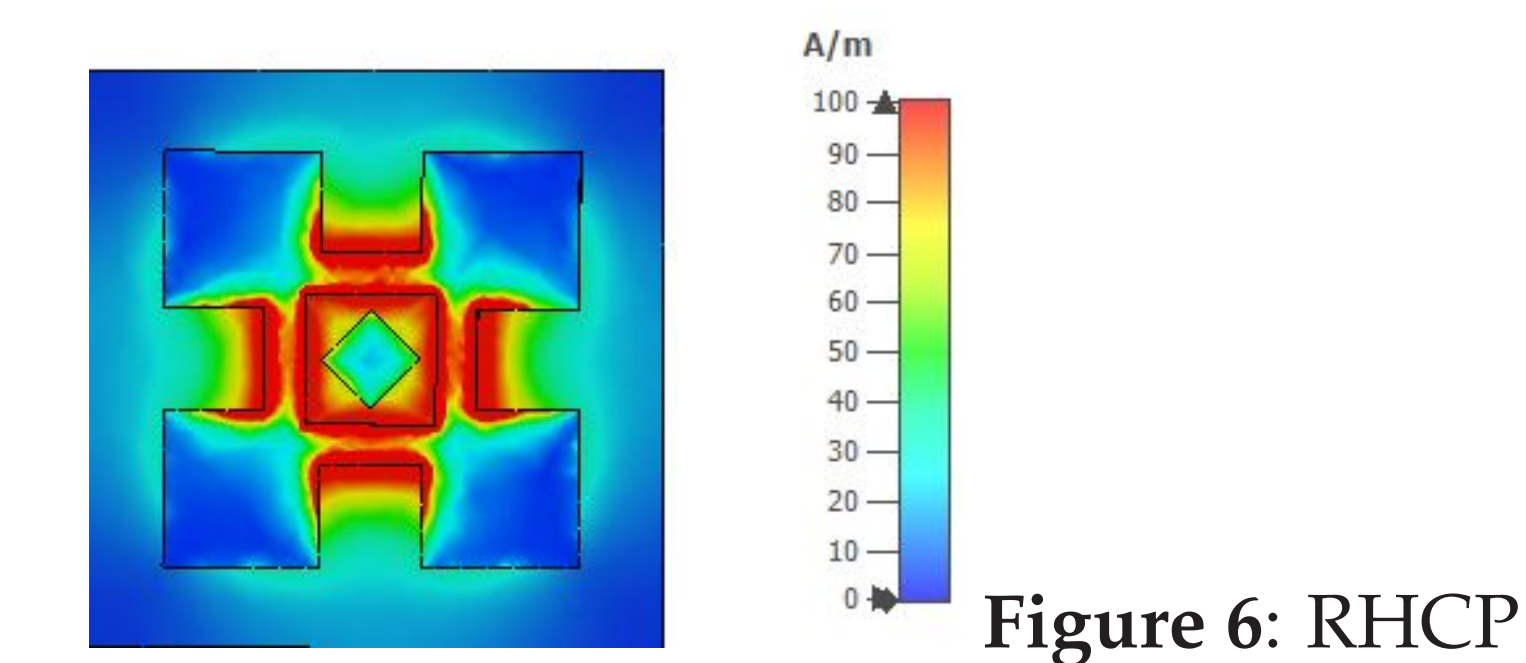

Figure 6: RHCP

## ABSORPTION COEFFICIENT

The Absorption Coefficient is given by the following equation :

$$A(\omega, \theta, \phi) = 1 - |S_{11}(\omega, \theta, \phi)|^2 - |S_{21}(\omega, \theta, \phi)|^2 \quad (1)$$

Fig.7 depicts the Absorption Coefficient as a function of Frequency With various polarized plane waves excitations : TE, TM, LHCP and RHCP.

From this figure, it is clearly shown that the response of the unit-cell is very less sensitive to the polarization of incident waves and absorption peaks reach 98.86 % at the operating frequency. Fig.8 and Fig.9 show also that the response is less sensitive to the polarization angle  $\phi$ , and the angle of incidence  $\theta$ .

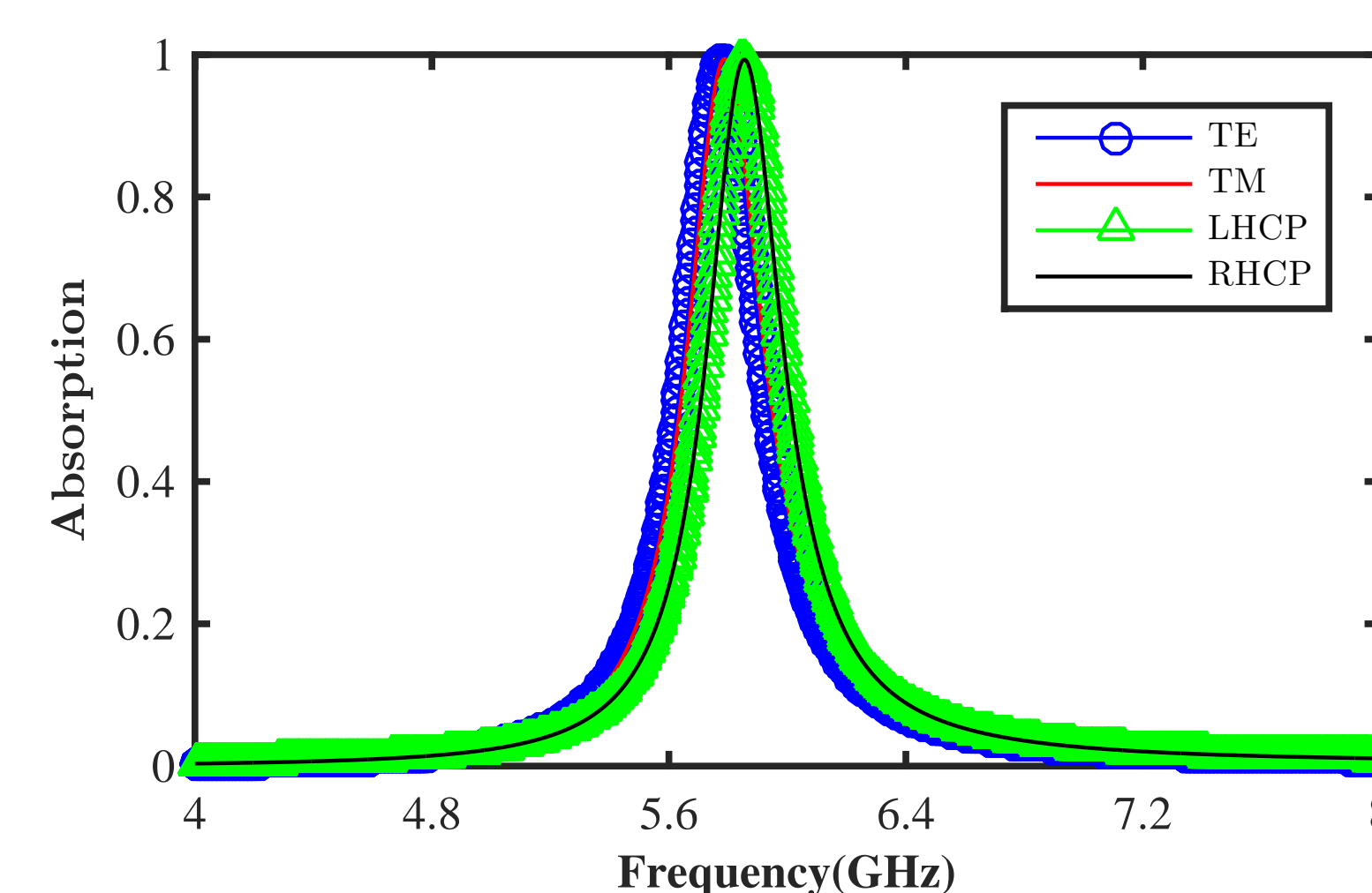

Figure 7: Absorption for different polarization

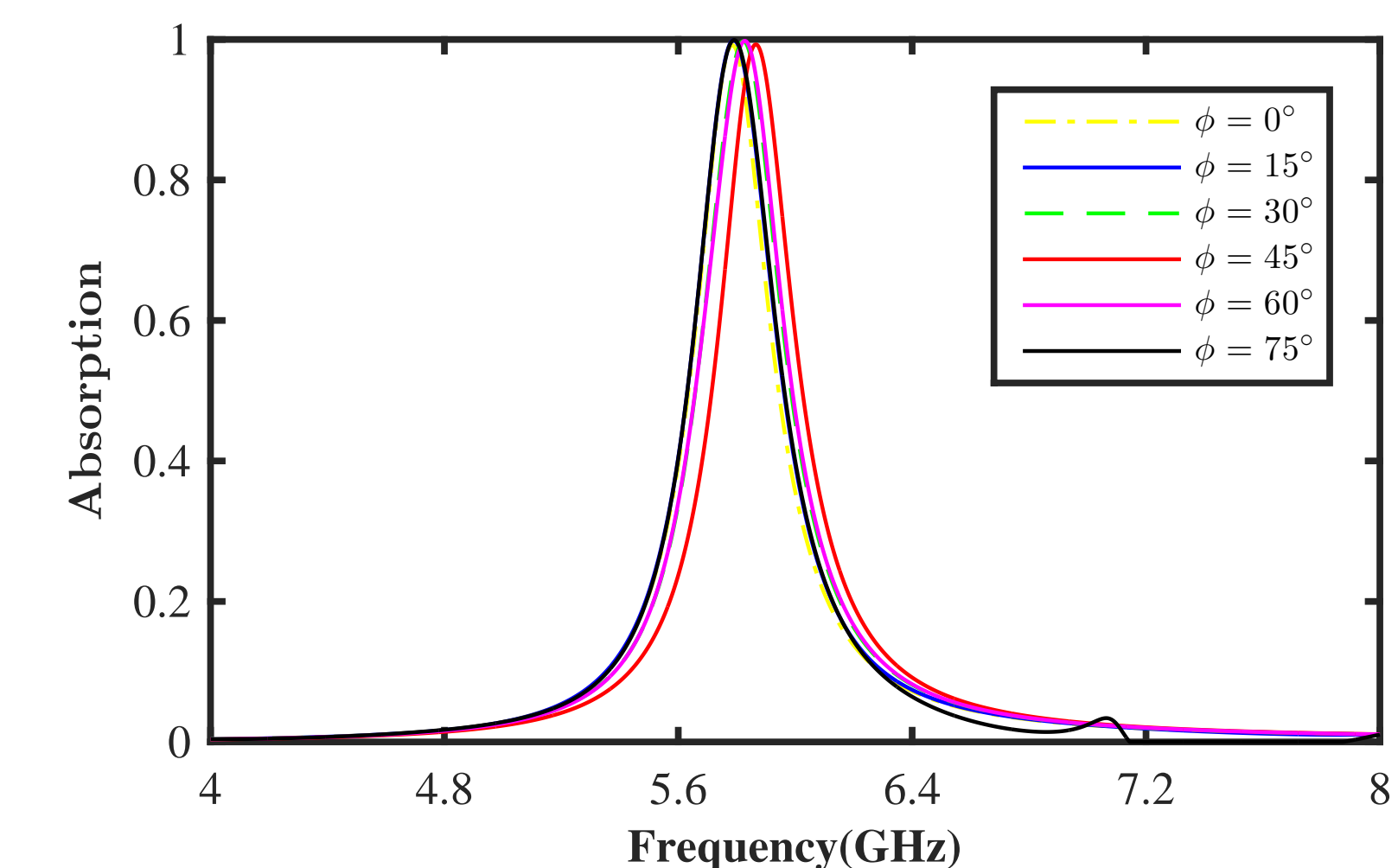

Figure 8: Absorption as a function of  $\phi$  ( $\theta = 0^\circ$ )

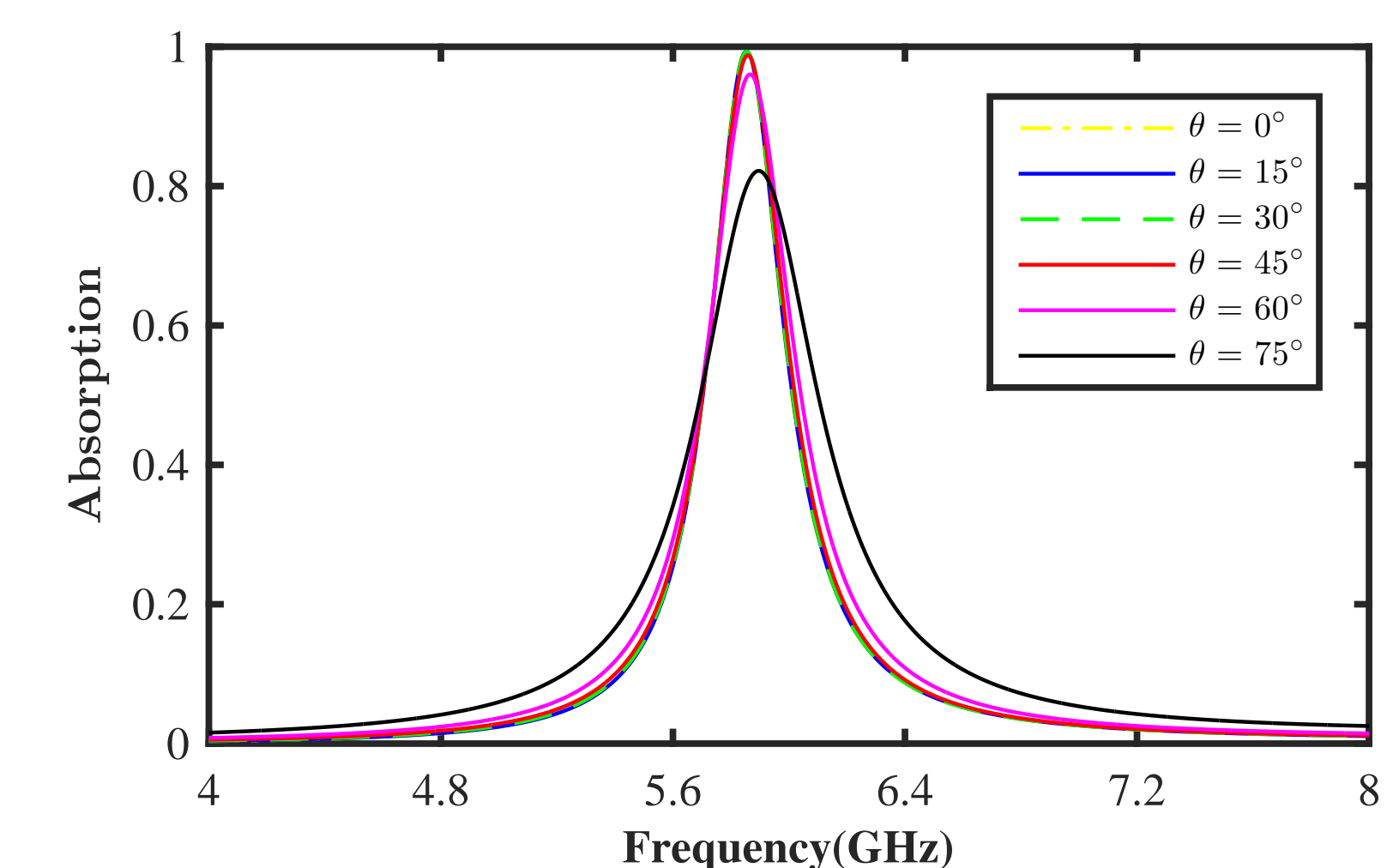

Figure 9: Absorption as a function of  $\theta$  ( $\phi = 0^\circ$ )

## EFFICIENCY AND VOLTAGE ACCROSS RESISTANCES

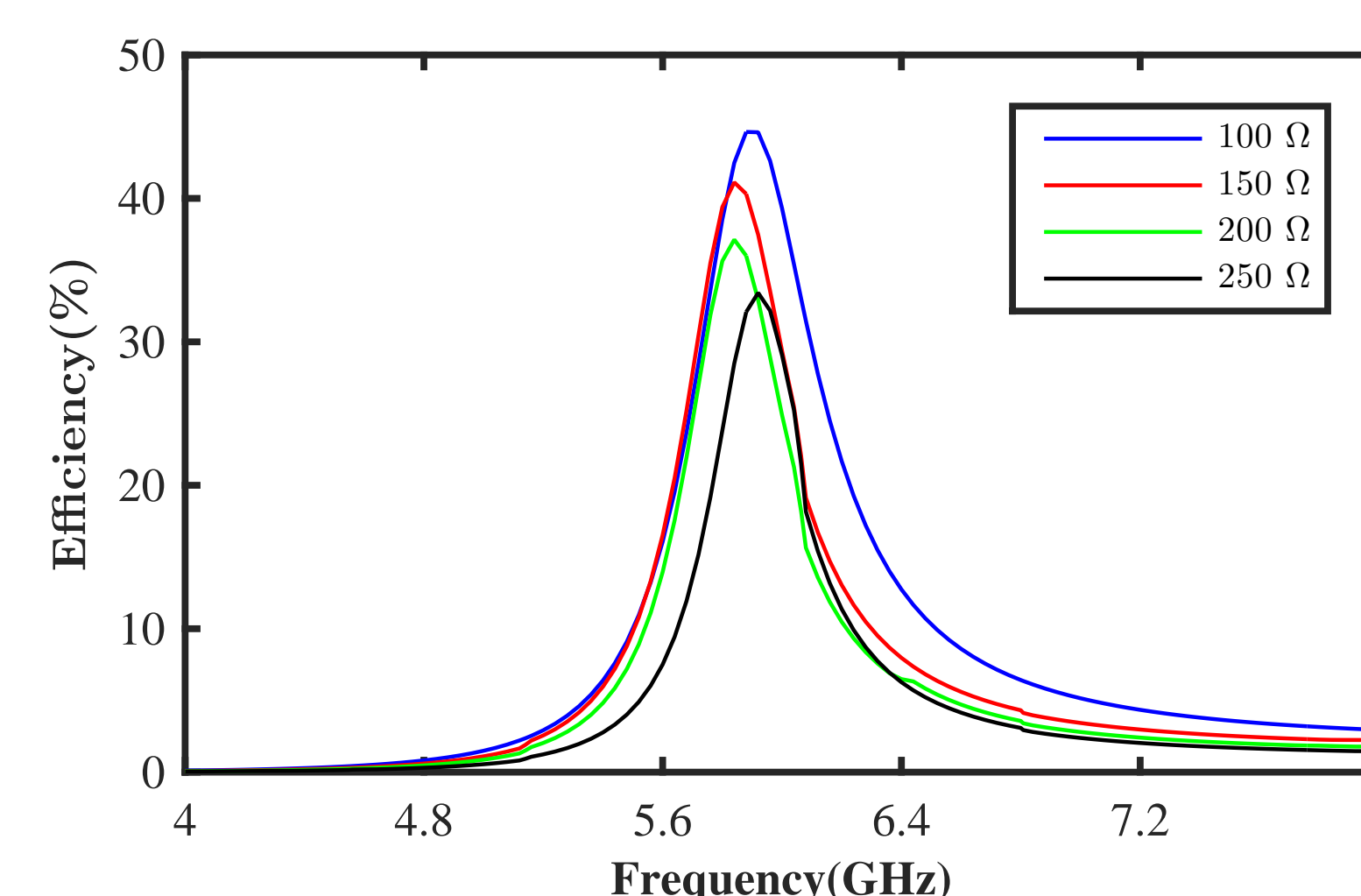

Figure 10: RF to AC Conversion efficiency

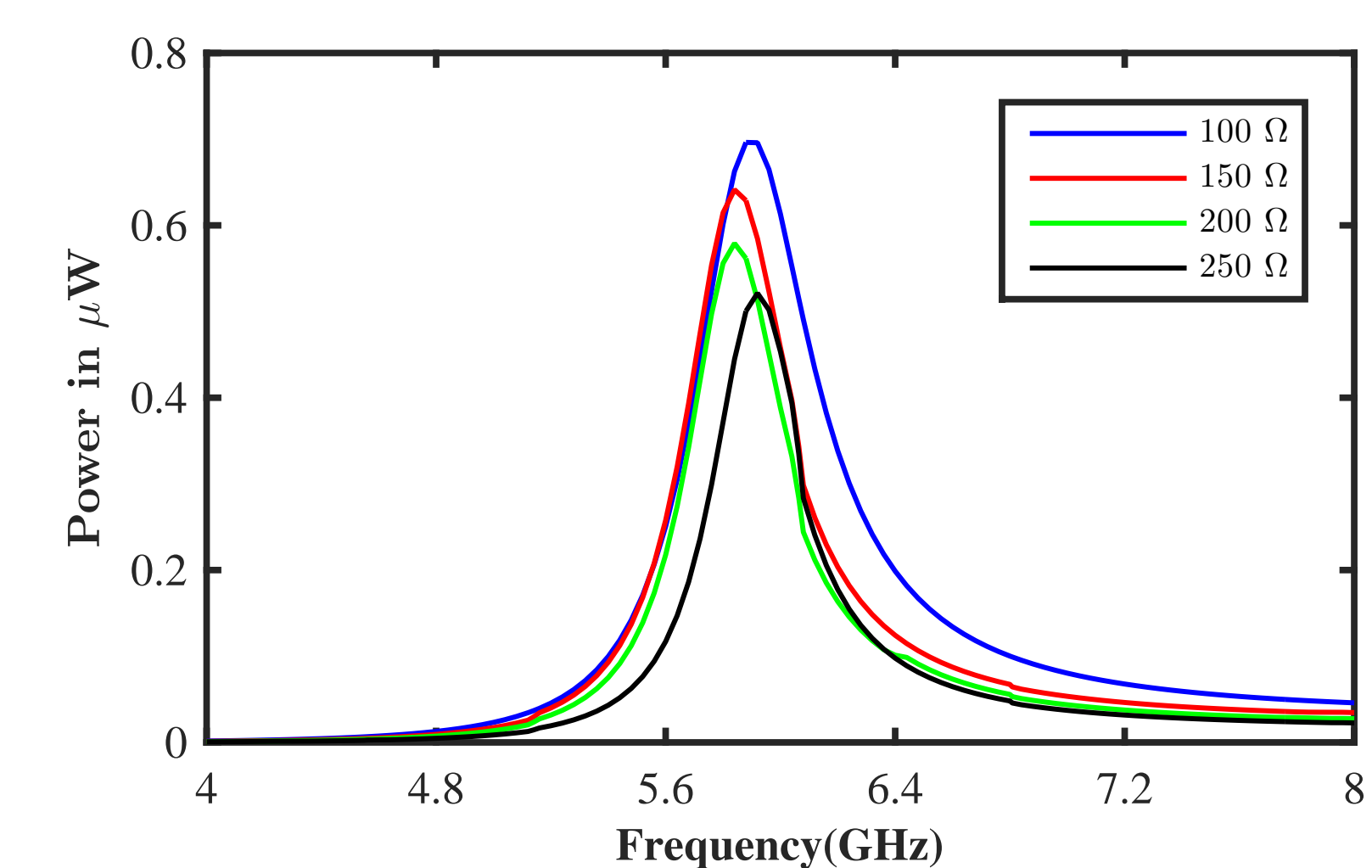

Figure 11: AC power as a function of frequency

Radiation to RF conversion efficiency is computed by

$$\eta (\%) = 100 \frac{P_L}{P_{in}} \quad (2)$$

Note that the magnitude of incident electric field vector was :  $E_{max} = 2.7$  V/m

Where  $P_{in}$  is given by :

$$P_{in} = \Re \left\{ \frac{1}{2} \int_A \vec{E} \times \vec{H}^* \cdot \vec{w} dA \right\} \quad (3)$$

## CONCLUSION AND FUTURE RESEARCH

In this work, we showed numerically that the proposed unit-cell can potentially be used for electromagnetic energy harvesting regardless of the polarization of incident waves with high absorption rate at 5.8 GHz. The experimental validation of the structure is planned. Also, an RF-to-dc conversion circuit will be integrated to complete the Metasurface Rectenna.

## CONTACT INFORMATION

- Email [said.choukri@univ-eiffel.fr](mailto:said.choukri@univ-eiffel.fr)  
 Email [hakim.takhedmit@univ-eiffel.fr](mailto:hakim.takhedmit@univ-eiffel.fr)  
 Email [oelmrabet@uae.ac.ma](mailto:oelmrabet@uae.ac.ma)  
 Email [Laurent.Cirio@univ-mlv.fr](mailto:Laurent.Cirio@univ-mlv.fr)