



HAL
open science

An Active Quenching Circuit for a Native 3D SPAD Pixel in a 28 nm CMOS FDSOI Technology

Mohammadreza Dolatpoor Lakeh, Jean-Baptiste Kammerer, Wilfried Uhring, Francis Calmon, Dylan Issartel, Jean-Baptiste Schell, Andreaia Cathelin

► **To cite this version:**

Mohammadreza Dolatpoor Lakeh, Jean-Baptiste Kammerer, Wilfried Uhring, Francis Calmon, Dylan Issartel, et al.. An Active Quenching Circuit for a Native 3D SPAD Pixel in a 28 nm CMOS FDSOI Technology. IEEE NEWCAS 2021, 2021, En ligne, France. 10.1109/NEWCAS50681.2021.9462754 . hal-03238121

HAL Id: hal-03238121

<https://hal.science/hal-03238121v1>

Submitted on 4 Dec 2024

HAL is a multi-disciplinary open access archive for the deposit and dissemination of scientific research documents, whether they are published or not. The documents may come from teaching and research institutions in France or abroad, or from public or private research centers.

L'archive ouverte pluridisciplinaire **HAL**, est destinée au dépôt et à la diffusion de documents scientifiques de niveau recherche, publiés ou non, émanant des établissements d'enseignement et de recherche français ou étrangers, des laboratoires publics ou privés.

An Active Quenching Circuit for a Native 3D SPAD Pixel in a 28 nm CMOS FDSOI Technology

Mohammadreza Dolatpoor Lakeh¹, Jean-Baptiste Kammerer¹, Jean-Baptiste Schell, Dylan Issartel², Francis Calmon², Andreaia Cathelin³ and Wilfried Uhring¹

Email: dolatpoorlakeh@unistra.fr

¹ICube laboratory, University of Strasbourg and CNRS, Strasbourg, France

²Nanotechnology institute of Lyon, University of Lyon and CNRS, Lyon, France

³STMMicroelectronics, Crolles, France

Abstract—The first Active Quenching - Active Reset (AQAR) circuit for a novel inherent 3D SPAD pixel is designed in a 28 nm CMOS Fully Depleted Silicon On Insulator (FDSOI) technology. Thanks to an ultra-fast detection circuit, the avalanche is detected in less than 50 ps and quenched in 200 ps. Thanks to this fast detection and active quenching, the avalanche charge in the Space Charge Region (SCR) is reduced by 50 % which should result in a 50 % afterpulsing reduction. With the proposed pixel, the fill factor is no longer limited by the associated circuitry.

Keywords—SPAD pixel, afterpulsing, avalanche charge, active quenching, fast detection, native 3D, CMOS FDSOI.

I. INTRODUCTION

Single Photon Avalanche Diodes (SPADs) have a wide range of applications, from biomedical imaging to autonomous vehicles industry. Due to its ability to detect weak light down to a single photon with a good timing accuracy, SPAD is used in Fluorescence Lifetime Imaging Microscopy, Light Detection and Ranging, Time-Correlated Single Photon Counting, 3D imaging, noninvasive VLSI circuits testing and many other applications [1][2].

Beside its advantages, SPAD suffers from two main noise sources, the Dark Count Rate (DCR) and the After Pulsing effect (AP). DCR is defined as the number of non-photo-generated avalanches when SPAD is placed in a complete darkness. The DCR is an uncorrelated noise, mainly caused by tunneling and thermally generated carriers. On the other side, the AP is a noise correlated to the signal. Indeed, when an avalanche occurs, some of carriers that flow through the Space Charge Region (SCR), are captured by traps inside the SCR. These traps release carriers after a random time, which generates spurious avalanches correlated to the previous main avalanche. DCR and AP degrade the SPAD maximal achievable signal to noise ratio [3].

A conventional solution to mitigate DCR, is cooling down the SPAD in order to reduce the thermal generation. However, on the other hand, increasing the temperature, makes trapped carriers to be released faster which results in after pulsing reduction [3]. Another way to reduce the AP is to increase the time interval between avalanches, in which the SPAD is biased out of its breakdown region (dead time). However, increasing the dead time, decreases the counting rate and so the dynamic range. Even though a clean semiconductor fabrication process, decreases the AP effect, many circuit solutions are also proposed to reach that goal. All these solutions are based on this fact that the AP effect is proportional to the number of trapped carriers. Therefore, an Active Quenching (AQ) circuit, that is able to lessen the avalanche charge within the SCR, and thus the number of trapped carriers, is expected to reduce the AP effect [4][5].

Founded by French National Research Agency (ANR-18-CE24-0010)

However, the peripheral circuitry required in these methods, reduces the pixel fill factor (the ratio between the SPAD active area and the total pixel area), increases the pixel pitch and consequently degrades the Photon Detection Efficiency (PDE). To overcome these tradeoffs, the 3D stacked structure, micro lenses and even a larger SPAD active area are proposed. In the 3D stacked structure, two separate dies, one hosting the SPAD and other one hosting electronics, are stacked together to increase the fill factor. This solution is costly and complex [1][6].

In this paper, we propose to take benefit of the Fully Depleted Silicon On Insulator (FDSOI) technology to design a native 3D pixel structure [7], including a novel ultrafast active quenching circuit, all in a single die, capable of achieving a high fill factor. The proposed pixel breaks the tradeoff between the AP effect and the fill factor. The pixel is designed in a 28 nm CMOS FDSOI technology in which the transistors are fabricated over an ultrathin buried oxide layer [8]. The oxide layer allows the integration of the electronics over the SPAD, (Fig. 1). This novel pixel structure paves the way for high density and high resolution smart SPAD arrays. Also, thanks to the buried oxide layer, the body biasing feature leads to a new avalanche sensing technique [9][10].

II. SPAD PIXEL IN FDSOI: A NATIVE 3D PIXEL

Fig. 1 illustrates a symbolic cross section of the inherent 3D SPAD pixel, in a CMOS FDSOI technology. The SPAD is realized at the junction of P-well and deep N-well, beneath the thin buried oxide layer. The associated electronics are fabricated in an ultrathin silicon film and placed on top of the buried oxide layer. In this new structure, the SPAD circuitry can be inscribed in the SPAD active area, and in combination with a back side illumination results in a high fill factor [7].

In our chosen SPAD configuration, the cathode is connected to a constant bias voltage while the P-well anode is the dynamic node. Despite its advantages, this

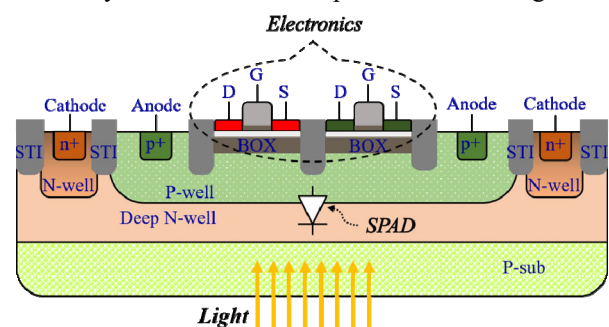

Fig. 1. A cross section of CMOS FDSOI technology. Integration of the SPAD and electronics in an inherent 3D structure with backside illumination (scales are not respected).

C. An Ultrafast and Compact SPAD Pixel

The combination of the ticklish detector in direct and the new indirect sensing method, results in an even faster detection since both the effects are added. The achieved inherently 3D, ultrafast AQAR circuit breaks the tradeoffs between the fill factor, the AP effect and the dynamic range. These proposed circuits are first ever reported AQAR circuits that exploit either direct or indirect sensing, or both sensing methods combined on a native 3D SPAD pixel.

IV. POST LAYOUT SIMULATION RESULTS

The proposed circuits have been designed and laid out in a 28 nm CMOS FDSOI technology. In Fig. 4 the layout of the Ticklish AQAR circuit in combined sensing mode is shown. The only difference between this layout and the layout of the ticklish AQAR circuit in indirect sensing mode is the coupling capacitance C_{FB} . The circuit occupies an area of about $14 \mu\text{m} \times 14 \mu\text{m}$, which is about 32 % of the area of our $28 \mu\text{m}$ diameter SPAD, therefore it can be completely placed over the SPAD, inside its active area. Most of the area is consumed by the delay line and there is still room to place more advanced signal processing circuits such as a counter or a compact time to digital converter. Along with a backside illumination the fill factor is not limited by the electronics and the pixel achieves the highest possible fill factor.

We used a Spice macro model for SPAD [13] to simulate the operation of the proposed circuits. The SPAD has a 100 fF junction capacitance and a 1 k Ω serial resistance. In order to measure the efficiency of the Ticklish AQAR circuits we compare all the results with the Passive Quenching (PQ) operation. To obtain more realistic results all simulations are made using post layout extracted schematic.

Fig. 5 shows the anode voltage when an avalanche occurs in active and passive quenching mode for both Ticklish AQAR circuits in combined sensing and indirect sensing. It is not possible to precisely determine when the avalanche is detected but in the anode voltage curve we can observe a slope change. This slope change means that after the avalanche detection, the circuit triggers the AQ PMOS to speed up the quenching. Therefore, surely the avalanche is detected in less than 50 ps in the combined sensing mode and in less than 100 ps for indirect sensing mode.

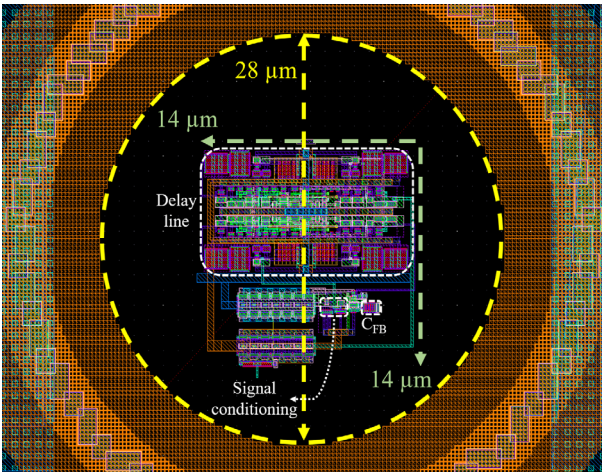

Fig. 4. Layout of the native 3D SPAD pixel. Ticklish AQAR circuit is inscribed in the SPAD active area.

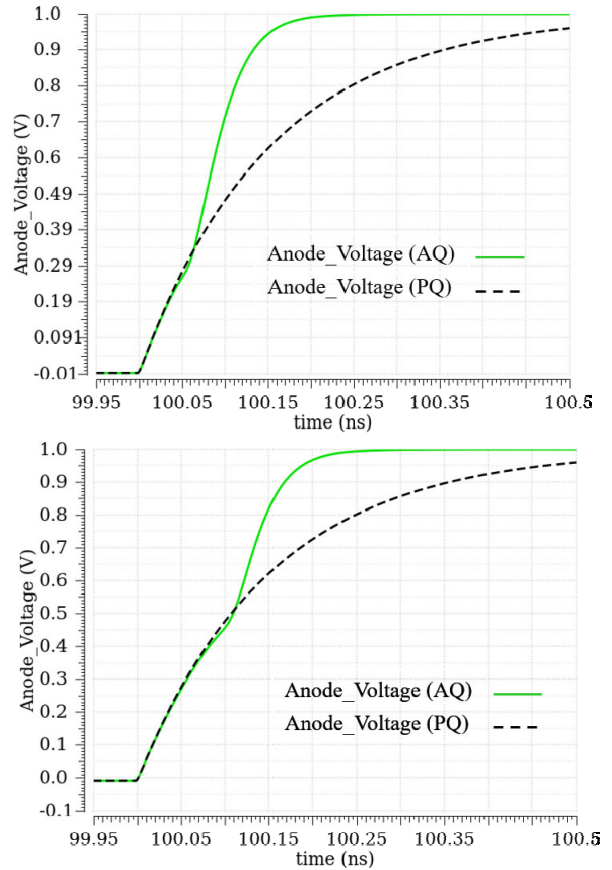

Fig. 5. Anode voltage variations when an avalanche occurs in both active and passive quenching modes. Direct+indirect sensing (top), indirect sensing (bottom).

Fig. 6 shows avalanche currents for both indirect and combined sensing circuits in active and passive quenching modes. As expected, a faster avalanche detection results in a faster quenching. According to Fig. 6, in the combined sensing circuit, the avalanche is actively quenched in about 200 ps while for the indirect sensing circuit, quenching time is about 240 ps. It should be noticed that the Ticklish AQAR circuit in combined and in indirect sensing mode quenches the avalanche respectively 3 times and 2 times faster than the corresponding passive quenching.

The surface under the avalanche current curve is equal to the avalanche charge in SCR. Fig. 7 is the result of taking integral from avalanche current curves in Fig. 6. The avalanche charge in SCR is reduced by 50 % and 30 %, respectively in combined and indirect sensing, regarding to the amount of the charge in PQ mode. It is observable in Fig. 7 that this reduction is due to the contribution of the AQ PMOS in the quenching process. Since there is a proportional relationship between the afterpulsing effect and the avalanche charge flowing through the SCR, Ticklish AQAR circuits in combined and indirect sensing should reduce the afterpulsing effect by 50 % and 30 % respectively.

V. CONCLUSION

In order to reduce the after pulsing effect, from a circuit design point of view, the avalanche charge flowing through the SCR should be reduced. In this paper an AQAR circuit based on an ultra-fast detection is proposed to speed up the quenching process and thus decreases the avalanche charge. Also with a novel inherent 3D SPAD pixel the circuitry does

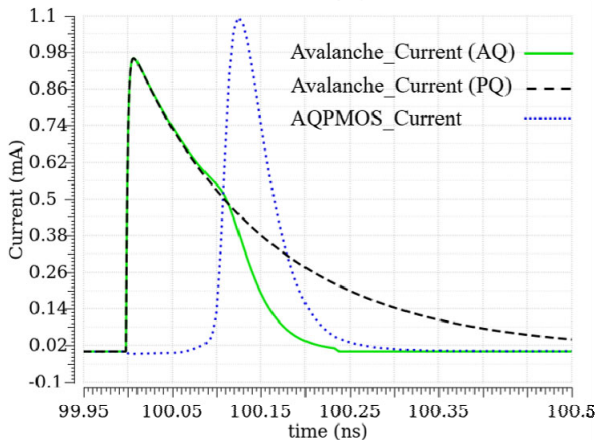
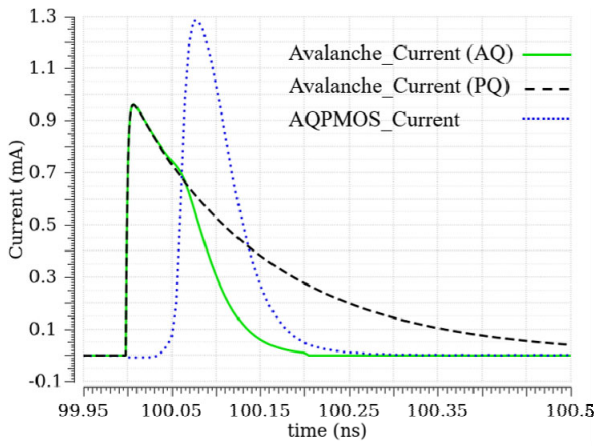

Fig. 6. Avalanche current and the current of active quenching transistor in both active and passive quenching modes. Combined sensing (top), indirect sensing (bottom).

not affect the fill factor and keep it at its highest possible value. Post extracted simulation results show that the Ticklish AQAR circuit detects the avalanche in less than 50 ps and quenches it in about 200 ps, which results in a 50 % avalanche charge reduction and consequently 50 % afterpulsing reduction. Therefore, the proposed pixel bypasses conventional tradeoffs between the AP, the dynamic range and the fill factor.

REFERENCES

- [1] M. Lee et al., "High-Performance Back-Illuminated Three-Dimensional Stacked Single-Photon Avalanche Diode Implemented in 45-nm CMOS Technology," in *IEEE Journal of Selected Topics in Quantum Electronics*, vol. 24, no. 6, pp. 1-9, Nov.-Dec. 2018, Art no. 3801809, doi: 10.1109/JSTQE.2018.2827669.
- [2] P. Sun, E. Charbon and R. Ishihara, "A Flexible Ultrathin-Body Single-Photon Avalanche Diode With Dual-Side Illumination," in *IEEE Journal of Selected Topics in Quantum Electronics*, vol. 20, no. 6, pp. 276-283, Nov.-Dec. 2014, Art no. 3804708, doi: 10.1109/JSTQE.2014.2342193.
- [3] D. P. Palubiak, Z. Li and M. J. Deen, "Afterpulsing Characteristics of Free-Running and Time-Gated Single-Photon Avalanche Diodes in 130-nm CMOS," in *IEEE Transactions on Electron Devices*, vol. 62, no. 11, pp. 3727-3733, Nov. 2015, doi: 10.1109/TED.2015.2475126.
- [4] F. Acerbi, A. D. Frera, A. Tosi and F. Zappa, "Fast Active Quenching Circuit for Reducing Avalanche Charge and Afterpulsing in InGaAs/InP Single-Photon Avalanche Diode," in *IEEE Journal of Quantum Electronics*, vol. 49, no. 7, pp. 563-569, July 2013, doi: 10.1109/JQE.2013.2260726.
- [5] D. Bronzi, S. Tisa, F. Villa, S. Bellisai, A. Tosi and F. Zappa, "Fast Sensing and Quenching of CMOS SPADs for Minimal Afterpulsing Effects," in *IEEE Photonics Technology Letters*, vol. 25, no. 8, pp. 776-779, April 15, 2013, doi: 10.1109/LPT.2013.2251621.

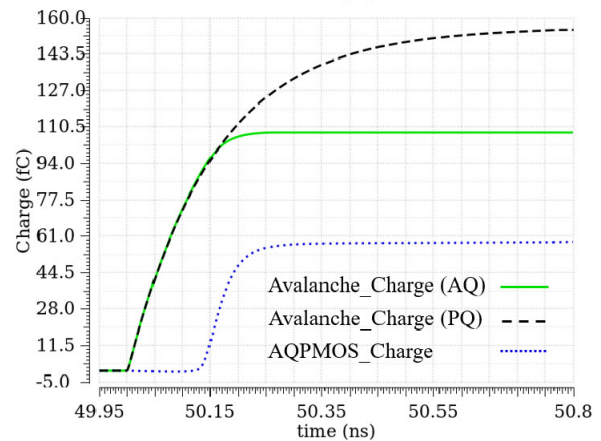
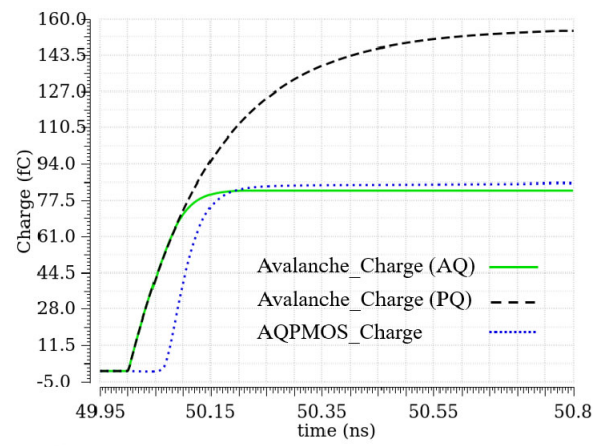

Fig. 7. Avalanche charge in SCR when an avalanche occurs in both active and passive quenching modes. Combined sensing (top), indirect sensing (bottom).

- [6] I. Gyongy et al., "A 256×256 , 100-kfps, 61% Fill-Factor SPAD Image Sensor for Time-Resolved Microscopy Applications," in *IEEE Transactions on Electron Devices*, vol. 65, no. 2, pp. 547-554, Feb. 2018, doi: 10.1109/TED.2017.2779790.
- [7] T. Chaves de Albuquerque et al., "Integration of SPAD in 28nm FDSOI CMOS technology," 2018 48th European Solid-State Device Research Conference (ESSDERC), Dresden, 2018, pp. 82-85, doi: 10.1109/ESSDERC.2018.8486852.
- [8] A. Cathelin, "Fully Depleted Silicon on Insulator Devices CMOS: The 28-nm Node Is the Perfect Technology for Analog, RF, mmW, and Mixed-Signal System-on-Chip Integration," in *IEEE Solid-State Circuits Magazine*, vol. 9, no. 4, pp. 18-26, Fall 2017, doi: 10.1109/MSSC.2017.2745738.
- [9] T. Chaves de Albuquerque et al., "Body-biasing considerations with SPAD FDSOI: advantages and drawbacks," ESSDERC 2019 - 49th European Solid-State Device Research Conference (ESSDERC), Cracow, Poland, 2019, pp. 210-213, doi: 10.1109/ESSDERC.2019.8901825.
- [10] T. Chaves de Albuquerque et al., "Indirect avalanche event detection of Single Photon Avalanche Diode implemented in CMOS FDSOI technology." *Solid-State Electronics* 163 (2020): 107636.
- [11] M. Dolatpoor Lakeh, J. -B. Kammerer, W. Uhring, J. -B. Schell and F. Calmon, "An Ultrafast Active Quenching Circuit for SPAD in CMOS 28 nm FDSOI Technology," 2020 IEEE SENSORS, Rotterdam, Netherlands, 2020, pp. 1-4, doi: 10.1109/SENSORS47125.2020.9278902.
- [12] D. Palubiak, M. M. El-Desouki, O. Marinov, M. J. Deen and Q. Fang, "High-Speed, Single-Photon Avalanche-Photodiode Imager for Biomedical Applications," in *IEEE Sensors Journal*, vol. 11, no. 10, pp. 2401-2412, Oct. 2011, doi: 10.1109/JSEN.2011.2123090.
- [13] A. Dalla Mora, A. Tosi, S. Tisa and F. Zappa, "Single-Photon Avalanche Diode Model for Circuit Simulations," in *IEEE Photonics Technology Letters*, vol. 19, no. 23, pp. 1922-1924, Dec. 1, 2007, doi: 10.1109/LPT.2007.908768.