



**HAL**  
open science

## Greenhouse gas emission reduction system in photovoltaic nanogrid with battery and thermal storage reservoirs

Paul Ortiz, Sylvain Kubler, Éric Rondeau, Jean-Philippe Georges, Giuseppe Colantuono, Alexander Alexandrovich Shukhobodskiy

### ► To cite this version:

Paul Ortiz, Sylvain Kubler, Éric Rondeau, Jean-Philippe Georges, Giuseppe Colantuono, et al.. Greenhouse gas emission reduction system in photovoltaic nanogrid with battery and thermal storage reservoirs. *Journal of Cleaner Production*, 2021, 310, pp.127347. 10.1016/j.jclepro.2021.127347 . hal-03235570

**HAL Id: hal-03235570**

<https://hal.science/hal-03235570v1>

Submitted on 13 Jun 2023

**HAL** is a multi-disciplinary open access archive for the deposit and dissemination of scientific research documents, whether they are published or not. The documents may come from teaching and research institutions in France or abroad, or from public or private research centers.

L'archive ouverte pluridisciplinaire **HAL**, est destinée au dépôt et à la diffusion de documents scientifiques de niveau recherche, publiés ou non, émanant des établissements d'enseignement et de recherche français ou étrangers, des laboratoires publics ou privés.



Distributed under a Creative Commons Attribution - NonCommercial 4.0 International License

# Greenhouse Gas Emission Reduction System in Photovoltaic Nanogrid with Battery and Thermal Storage Reservoirs

Paul Ortiz<sup>a,\*</sup>, Sylvain Kubler<sup>a,\*</sup>, Éric Rondeau<sup>a</sup>, Jean-Philippe Georges<sup>a</sup>, Giuseppe Colantuono<sup>b</sup>, Alexander Alexandrovich Shukhobodskiy<sup>b</sup>

<sup>a</sup>Université de Lorraine, CNRS, CRAN, F-54000, France

<sup>b</sup>Leeds Beckett University, Leeds, United Kingdom.

## Abstract

The residential sector accounts for 30% of the total green house gas emissions in Europe, which can be reduced either by switching to low-carbon technologies or reducing the amount of fossil fuel energy consumed. In this work, a new greenhouse gas emission (GHGE) reduction system at the house (nanogrid) level is investigated. The originality of the proposed system and underlying algorithm lies in the fact that it acts in a proactive manner, by continuously controlling and optimizing energy flows between on-site local power production systems (photovoltaics - PV - array in our case), loads, and storage units (combining battery and thermal storage reservoirs). This system/algorithm is evaluated based on real-life input datasets from the United Kingdom (UK) and France, and compared with traditional house energy infrastructures, namely (i) a house not fitted with battery, and (ii) a house fitted with battery but without additional "smart" software layer. Results show that it performs better in terms of CO<sub>2</sub> (capacity of the algorithm to reduce the amount of non carbon-free energy consumed from the grid), Power to Grid (capacity to maximize the use of local green energy), and financial cost (capacity to reduce the overall electricity bill), respectively improving performance by up to 8%, 10% and 37%.

**Keywords:** Greenhouse Gas Emission, Carbon footprint, Energy efficiency, Photovoltaics, Battery, Nanogrid

## 1. Introduction

Buildings account for a significant proportion of global energy demand, GHGE, waste generation and resource demands. According to the results of the 21<sup>st</sup> Conference of the Parties on Climate Change (COP21), held in Paris in 2015, the building sector is responsible for 40% of worldwide energy consumption and 30% of GHGE (Baek and Kim, 2020; Wang et al., 2020). Reducing GHGE can be achieved by either switching to low-carbon technologies or reducing the amount of fossil fuel energy consumed (Holdren, 2006; Blackburn et al., 2017; Lazarus and van Asselt, 2018).

The scope and focus of this research is on the latter, namely the investigation of innovative solutions to reduce fossil fuel energy consumption at the house/building level. Such an objective can be achieved at several

*\*Corresponding author*  
*Preprint submitted to Elsevier*

*Email addresses:* paul.ortiz@univ-lorraine.fr (Paul Ortiz), s.kubler@univ-lorraine.fr (Sylvain Kubler), eric.rondeau@univ-lorraine.fr (Éric Rondeau), jean-philippe.georges@univ-lorraine.fr (Jean-Philippe Georges), G.Colantuono@leedsbeckett.ac.uk (Giuseppe Colantuono), A.Shukhobodskiy@leedsbeckett.ac.uk (Alexander Alexandrovich Shukhobodskiy)

May 11, 2021

19 phases of the energy lifecycle, as depicted in Figure 1. At the generation phase, research usually focuses on  
20 the design of weather dependent power generators, along with high capacity energy storage systems (Li et al.,  
21 2020; Lai et al., 2020). At the transmission and distribution phases, "smart grid" is an omnipresent topic  
22 (Dileep, 2020; Rahim et al., 2019), which is tightly coupled with the digital information flow allowing for  
23 both continuous monitoring of the demand, and control of the grid itself. Then, a large research community  
24 focuses on in-house solutions, spanning from the design of demand side management strategies (Wen et al.,  
25 2020; Mendes et al., 2020) to advanced metering and/or nanogrid architectures (Burmester et al., 2017;  
26 Kalair et al., 2020). The research work presented in this manuscript, which is developed as part of the  
27 RED WoLF project (standing for: *Rethink Electricity Distribution Without Load Following*) funded by the  
28 European Union (EU) programme Interreg North-West Europe (NWE), focuses on and contributes to the  
29 latter topic (i.e., nanogrid). Although definitions of what a nanogrid are discussed later in this paper, let us  
30 emphasize that the proposed system acts for a single home without gas connection, continuously controlling  
31 on-site local power production systems and loads, with the option of using green energy stored locally. The  
32 originality of the proposed RED WoLF system and underlying algorithm, compared with state-of-the-art  
33 solutions, is threefold:

- 34 i. RED WoLF introduces an innovative CO<sub>2</sub>-based progressive threshold approach, based on an optimiza-  
35 tion algorithm which is developed to decide when non carbon-free energy (from the grid) should be  
36 drawn to supply/charge in-house equipment;
- 37 ii. RED WoLF includes battery and thermal storage reservoirs, including storage heaters and water cylin-  
38 ders;
- 39 iii. RED WoLF system/algorithm is continuously executed, whose decisions are taken in real-time using  
40 on-site monitored data (via sensors) and predicted data (PV, CO<sub>2</sub>, home consumption).

41 Section 2 provides background information about the scope and focus of this research. Section 3 introduces  
42 the proposed RED WoLF's GHGE reduction system and underlying algorithm, which first and foremost  
43 focuses on CO<sub>2</sub>. Section 4 provides experimental evidence that the proposed system performs better than  
44 traditional ones in terms of CO<sub>2</sub> (capacity to reduce the amount of consumed non carbon-free energy), power  
45 to grid (capacity to maximize the use of local green energy), and financial (capacity to reduce the electricity  
46 bill). In this respect, real-life datasets from UK and France are considered for evaluation purposes (i.e. PV  
47 generation, house consumption). Conclusion and research perspectives are discussed in section 6.

## 48 2. Scope, Definition and Positioning

49 Section 2.1 provides the necessary background information to understand where our contribution stands  
50 in the energy field. Section 2.2 discusses the extent to which our research is different from the existing

51 literature.

52 *2.1. Scope and Definition*

53 Figure 1 based on (Saleem et al., 2019), provides a cartography of the power life cycle, which consists  
 54 of: (i) *power systems*: corresponding to the physical infrastructure; (ii) *Power flow*: representing the power  
 55 exchanges occurring from its generation to its consumption; (iii) *Information flow*: symbolizing the size  
 56 of the underlying networks infrastructures, from wide area networks to home area networks. The research  
 57 work presented in this work falls within the scope of Home Area Network (Consumption) phase, and more  
 58 specifically in the scope of “Nanogrid”. One may wonder why we talk about Nanogrid and not Microgrid ?  
 59 Although there is nothing in the microgrid definition to say it cannot be confined to a single home/building,  
 60 we adopt, as suggested by Burmester et al. (2017), that single home microgrids should adopt the term  
 61 nanogrid for three reasons: (i) nanogrids play a different role to microgrids in the power hierarchy (e.g.,  
 62 by connecting multiple nanogrids a microgrid can be formed); (ii) the potential markets for nanogrids are  
 63 different to that of microgrids. A nanogrid allows a power structure to be obtained at a relatively low cost  
 64 compared to microgrids, thus shifting the interest from large/multiple investors to small ones; (iii) as the  
 65 nanogrid structure is confined to a single home, the technical goals, hardware and software often vary from  
 66 that of a microgrid.

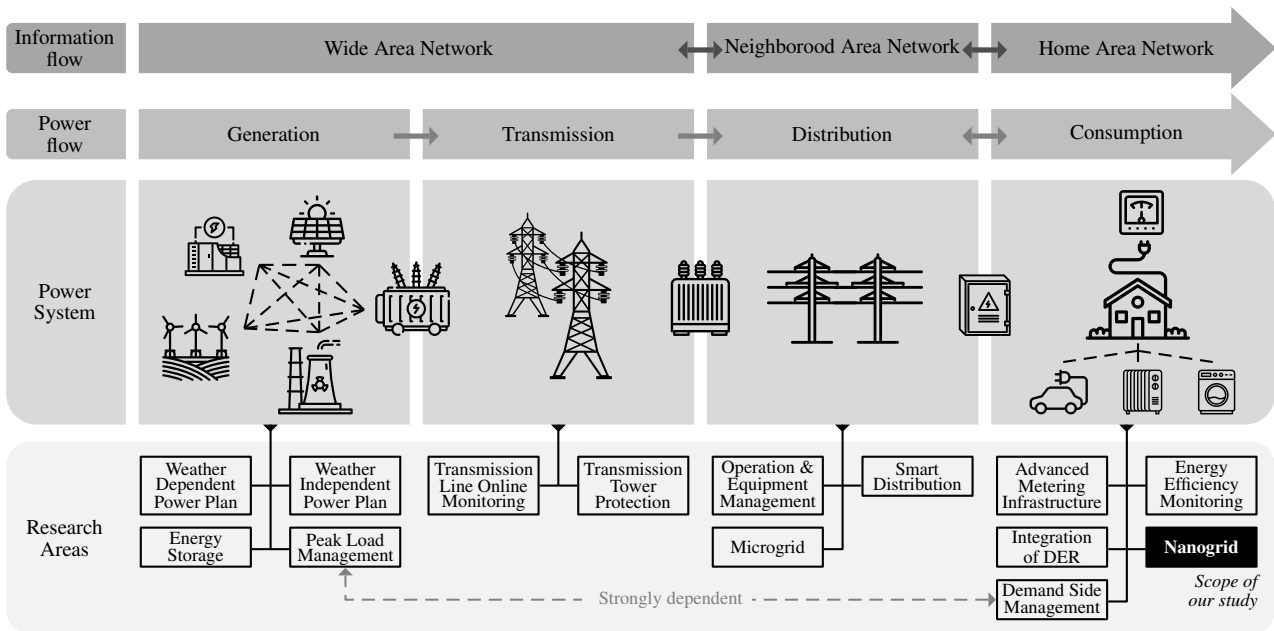

Figure 1: Power system overview (adapted from (Saleem et al., 2019))

67 A wide range of scientific and technological challenges related to nanogrid are addressed in the literature,  
 68 spanning from the design of new DC converters for nanogrid (Xie et al., 2020; Wu et al., 2016), new appliance

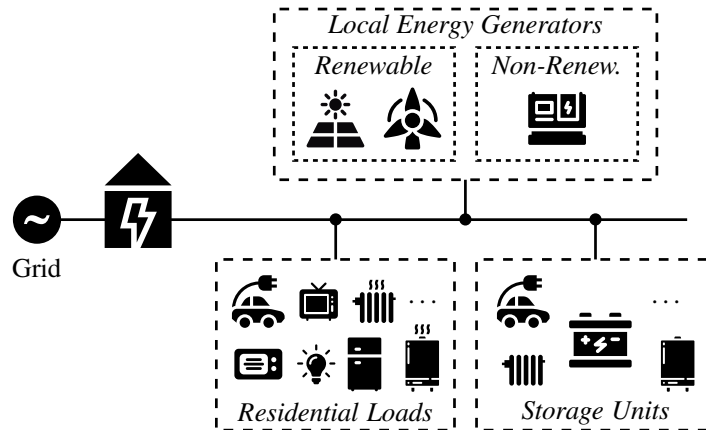

Figure 2: Nanogrid main technological constituents : figure adapted from (Ahmed et al., 2019)

69 task scheduling optimization and demand-side management strategies (Kalair et al., 2020; Sahin et al., 2019),  
 70 to innovative plug-in electric vehicle optimization strategies (Wu et al., 2017; Shamshirband et al., 2018).  
 71 Despite this wide scope of research, they all rely on a common set of technological constituents (or building  
 72 blocks), which can be declined into three main categories, as illustrated in Figure 2:

- 73 • *Local energy generator(s)*: including both/either renewable generators (e.g., Solar PV arrays, wind) or  
 74 non-renewable ones (e.g., diesel, gas, stirling):
- 75 • *Residential loads*: referring to home equipment that consume energy (e.g., appliances, car);
- 76 • *Local energy storage units*: referring to equipment able to store energy for later use, including batteries,  
 77 storage heaters, water cylinders, or still electrical vehicles;

78 In the next section state-of-the-art studies that focus on similar objectives as RED WoLF (i.e., reduction  
 79 of GHGE in PV nanogrid) are discussed, along with the extent to which they differ from RED WoLF.

## 80 2.2. Positionning of RED WoLF in the Literature

81 Many scientific studies have addressed the subject of GHGE reduction and electricity consumption op-  
 82 timization at the nanogrid level<sup>1</sup>. These studies span from the implementation of basic mechanisms based  
 83 solely on temperature readings (TAŞTAN, 2019; Marinakis and Doukas, 2018) to the integration of predictive  
 84 models considering meteorological information or still inhabitant behaviors (Ngarambe et al., 2020; Goudarzi  
 85 et al., 2019). With the problems related to global warming, the optimization criterion is changing, increas-  
 86 ingly focusing on the consumption of renewable energies for carbon dioxide emission reduction (Adams and  
 87 Nsiah, 2019; Kahia et al., 2019).

<sup>1</sup>Given the definition adopted earlier (*cf.*, section 2.1), i.e. that single home micro-grids are referred to as nanogrid.

88 In this respect, a comprehensive economic evaluation of a residential building with solar PV and battery  
89 energy storage systems is carried out by [Akter et al. \(2017\)](#) considering an Australian use case. The evaluation  
90 compares different scenarios, which can be divided into two categories: (1) savings/benefits resulting from  
91 the use of solar PV unit only; (2) savings/benefits resulting from the use of solar PV unit combined with  
92 a battery-based energy storage system. From a CO<sub>2</sub> perspective, in both cases the reduction of emissions  
93 increases along with the size of the solar PV units, however PV units with smaller capacities are more  
94 viable options from a return on investment perspective. Although the results of this study are interesting  
95 to understand how a given PV and a battery design could impact on savings/benefits, the study remains at  
96 the evaluation stage and does not propose any new optimization layer (e.g., to reduce CO<sub>2</sub>, bills, *etc.*).

97 Other research works do introduce such optimization models. [Ban et al. \(2019\)](#) formalize a capacity  
98 planning problem, along with an algorithm seeking to determine the optimal sizing of PV generation and  
99 batteries for nanogrid. This optimization minimizes the investment cost, while guaranteeing the desired level  
100 of reliability in the energy supply. This work is interesting as it allows system designers to select the best  
101 suited PV and battery sizes, however, such an analysis is carried out off-line (i.e. in the design phase of the  
102 systems), while, in RED-WoLF, the goal is to achieve continuous optimization in an on-line and continuous  
103 mode.

104 Several studies have developed on-line (real-time) optimization solutions. Among others, [Leonori et al.](#)  
105 [\(2016\)](#) presented an approach to enhance energy trading tasks and maximize the prosumer gain from an  
106 electricity price viewpoint (by deciding when to charge/discharge the battery). [Arun and Selvan \(2017\)](#)  
107 propose an online algorithm to minimize the electricity bill by taking advantage of low electricity pricing  
108 intervals. [Ock et al. \(2016\)](#) introduce a conceptual framework that takes into account weather data changes in  
109 order to adjust the energy used for lighting or still HVAC (Heating, Ventilation, Air-Conditioning) operational  
110 scheduling. A weakness of these last three presented works is the non-consideration of the CO<sub>2</sub> impact in  
111 the optimization function.

112 Several studies have proposed multi-objective optimization models to balance the competing goals of  
113 minimizing electricity costs for the home owner as well as minimizing CO<sub>2</sub> emissions. [Huang et al. \(2012\)](#)  
114 propose an algorithm maximizing the amount of energy produced locally (via PV) to the grid. However, in  
115 our opinion, selling energy is not always the best solution (or not allowed by energy provider), as it could be,  
116 in some cases, better to save this energy for future use when purchased energy price will increase. [Olivieri](#)  
117 [and McConky \(2020\)](#) present an innovative optimization model used to develop optimal battery charge and  
118 discharge schedules under three different objectives: minimize time dependent energy costs, minimize carbon  
119 emissions, and a multi-objective model that considers both energy costs and carbon emissions by including  
120 a social cost of carbon. In the same vein, [Haidar et al. \(2018\)](#) propose a real-time consumer-dependent  
121 energy management system for smart buildings, which is designed to find a trade-off between the energy cost

122 (either renewable or non-renewable) and its carbon impact. One limitation from these last two presented  
123 works is the non-consideration of forecasts, which somehow hinders the system’s ability to react to non-  
124 expected behaviors (e.g., in terms of CO<sub>2</sub> emission, energy price, PV generation, home consumption) over  
125 the forthcoming hours or days. Such forecasting is being considered by [Moradi et al. \(2016\)](#), where a 24 hours  
126 ahead optimization of PV-Wind hybrid systems with battery storage is performed in order to meet the load  
127 requirements. Nonetheless, the authors do not take into account CO<sub>2</sub> forecasts (only PV, wind and load  
128 forecasts being considered). Let us add that all the previously introduced research works do not consider  
129 thermal reservoirs as storage units in their model, which prevents to increase (i) the storage capacity of the  
130 overall system; and (ii) the flexibility in the optimization process. RED WoLF and the present study are  
131 committed to overcome these limitations.

132 One may also point out studies considering both stationary and mobile batteries (e.g., electric vehicle)  
133 in the optimization process ([Mahmud et al., 2018](#); [Gomes and Suomalainen, 2020](#)), with the possibility to  
134 add specific constraints (e.g., “allow for discharging the mobile battery but yet maintain a range of 25 km”).  
135 However, the use of mobile battery systems is out of scope of RED WoLF.

### 136 3. RED WoLF’s GHGE Reduction System

137 The RED WoLF’s GHGE reduction system consists of three steps. First, the necessary input data sources  
138 to run the proposed optimization algorithm are collected/accessed. Second, a CO<sub>2</sub> threshold used for later  
139 optimization stages is computed. Third, a GHGE reduction logic is specified based on the computed CO<sub>2</sub>  
140 threshold. These three steps are respectively detailed in sections 3.1, 3.2 and 3.3. Note that a primary  
141 version of the threshold computation was formalized in ([Shukhobodskiy and Colantuono, 2020](#)).

#### 142 3.1. Input data sources

143 Several input data sources must be accessed/monitored in order run the proposed GHGE reduction logic.  
144 These data sources can be divided into three categories, as depicted in Figure 3, namely:

- 145 i. *Pre-defined parameter values*: this category corresponds to fixed parameters such as manufacturers’ data  
146 (e.g., maximum battery capacity and power intake);
- 147 ii. *Real-time monitored values*: this category corresponds to data monitored on-site, which includes smart  
148 meter-, heater-, cylinder- (water tank-), PV- and home appliance-related data;
- 149 iii. *Predicted dataset values*: this category corresponds to predicted dataset patterns, and particularly the  
150 predicted CO<sub>2</sub> generated by the grid for a given forthcoming period of time, as well as the predicted PV  
151 and home consumption.

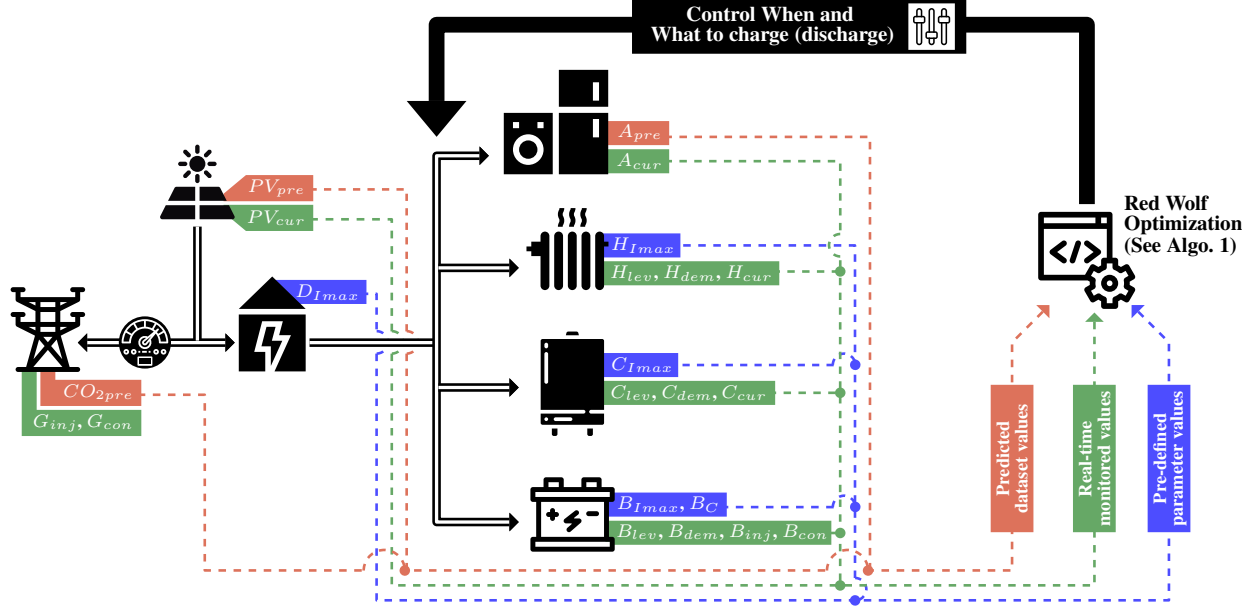

Figure 3: RED WoLF's GHGE reduction system overview

152 Table 1 provides the list of data sources that need to be accessed/monitored for each of the above  
 153 categories, as well as the algorithm outputs and internal algorithm variables. In the next section, the notion  
 154 of "CO<sub>2</sub> threshold" is introduced and formalized, which is key to the proposed GHGE reduction logic.

### 155 3.2. CO<sub>2</sub> Threshold identification

156 To compute what is referred to as CO<sub>2</sub> threshold, denoted by  $CO_{2thr}$ , several computational steps must  
 157 be conducted.

First, the predicted average remaining power drawable from the grid (denoted by  $G_{PU}$ ) and the predicted energy consumed by appliances and thermal reservoirs until the end of the day (denoted by  $D_{ED}$ ) must be estimated. The former ( $G_{PU}$ ), which can be understood as the available amount of instantaneous power to charge home storage reservoirs (i.e., storage heaters and cylinder), is computed based on Eq. (1), where  $D_{Imax}$ ,  $A_{pre}$  and  $B_{Imax}$  respectively refer to the maximum house power intake allowed by the energy provider, the estimated forthcoming power consumed by appliances, and the maximum battery's intake limitation. The latter ( $D_{ED}$ ), which represents the remaining amount of energy required to reach the setpoint for the next day, is computed based on Eq. (2), where  $H_{dem}$  and  $C_{dem}$  respectively refer to heater and cylinder current power demands (which are computed based on Eq. (3) and (4)), and  $H_{lev}$  and  $C_{lev}$  to the current level of energy still available in the heater and cylinder. The "Heavi" (Heaviside step function) function



Table 1: Variable definitions

Type	Variable	Units	Description
Input	$A_{cur}$	kW	Current power injected to appliances
	$A_{pre}$	kW	Predicted power to be injected to the appliances
	$CO_{2cur}$	gCO <sub>2</sub> /kWh	Current grid CO <sub>2</sub> load
	$CO_{2pre}$	gCO <sub>2</sub> /kWh	Predicted grid CO <sub>2</sub> load
	$PV_{cur}$	kW	Current PV production
	$PV_{pre}$	kW	Predicted PV production
Output	$B_{con}$	kW	Power drawn from the battery
	$B_{inj}$	kW	Power stored in the battery
	$C_{cur}$	kW	Power stored in the water cylinder
	$G_{con}$	kW	Power drawn from the grid
	$G_{inj}$	kW	Power injected to the grid
	$H_{cur}$	kW	Power stored in the storage heater
Internal	$B_C$	kWh	Charging capacity of the battery
	$B_{dem}$	kW	Current battery's power demand
	$B_{I_{max}}$	kW	Maximum battery intake power
	$B_{lev}$	kWh	State/Level of charge of the battery
	$C_{dem}$	kW	Current water cylinder's power demand
	$C_{I_{max}}$	kW	Maximum water cylinder's power intake
	$C_{lev}$	kWh	State/Level of charge of the watercylinder
	$C_{set}$	kWh	Setpoint of cylinder
	$D_{ED}$	kWh	Predicted energy consumed by appliances until the end of the day
	$D_{I_{max}}$	kW	Maximum equipment usable power set by the electricity provider
	$D_{I_{max}APV}$	kW	Maximum equipment usable power including PV and appliances
	$G_{PU}$	kW	Predicted average remaining power drawable from the grid
	$H_{dem}$	kW	Current storage heater's power demand
	$H_{I_{max}}$	kW	Maximum storage heater's power intake
	$H_{lev}$	kWh	State/Level of charge of the storage heater
	$H_{set}$	kWh	Setpoint of storage heater
$P_{bal}$	kW	Power balance after powering appliances and equipment supply	
$CO_{2thr}$	gCO <sub>2</sub> /kWh	CO <sub>2</sub> threshold over which grid drawing is not allowed	
$T_I$	min	Minimum time to supply equipment and appliances	

represents is defined as “1” if the input parameter is positive, “0” otherwise.

$$G_{PU} = D_{I_{max}} - \int_t^T \frac{A_{pre}(t)}{(T-t)} dt - B_{I_{max}} \quad (1)$$

$$D_{ED} = \int_t^T \frac{A_{pre}(t)}{60} dt + \sum_{i=H,C} (i_{dem} - i_{lev}) \quad (2)$$

$$H_{dem} = H_{I_{max}} \times Heavi(H_{set} - H_{lev}) \quad (3)$$

$$C_{dem} = C_{I_{max}} \times Heavi(C_{set} - C_{lev}) \quad (4)$$

Based on  $G_{PU}$  and  $D_{ED}$ , the minimum time length to charge equipment in parallel of supplying home appliances, is computed based on Eq. (5) (denoted by  $T_I$ ).

$$T_I = \max\left(\frac{D_{ED}}{G_{PU}}, \frac{H_{dem} - H_{lev}}{H_{I_{max}}}, \frac{C_{dem} - C_{lev}}{C_{I_{max}}}\right) \quad (5)$$

Finally, the  $CO_2$  threshold ( $CO_{2thr}$ ), which identifies when it is optimal to draw energy from the grid, is computed based on Eq. (7), where  $CO_{2preSort}$  corresponds to  $CO_2$  prediction vector sorted in descending order as given in Eq. (6). Note that the ceil function is required here in order to obtain an integer, which refers to the drawing time (in minutes) that represents the index of the  $CO_2$  threshold in the sorted  $CO_2$  vector.

$$CO_{2preSort} = sort(CO_{2pre}) \quad (6)$$

$$CO_{2thr} = CO_{2preSort}(\lceil T_I \rceil) \quad (7)$$

158 Figure 4 provides a graphical representation of what the above-introduced equations result in. Overall,  
 159 once  $T_I$  is obtained/computed (which is equal to 7h in this example), a threshold that meets this charging  
 160 duration is identified. In our example, the first threshold (denoted by  $CO_2^a$  in Figure 4) does not meet this  
 161 requirement, while the second threshold ( $CO_2^b$ ) does, resulting in two “low  $CO_2$  periods”: [8am; 10am] and  
 162 [2pm; 6pm].

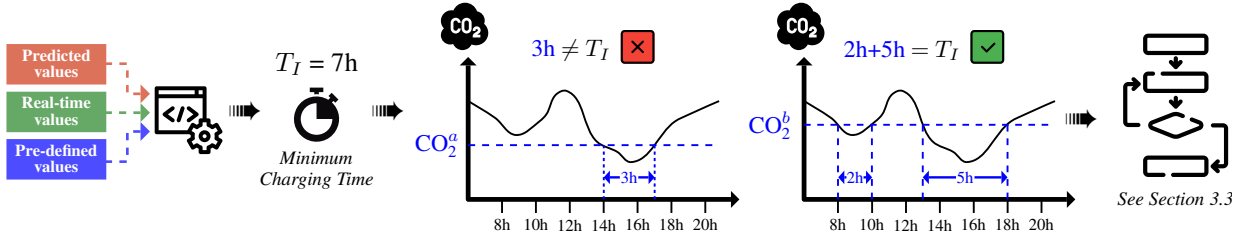

Figure 4: Illustration of the  $CO_2$  threshold computation used in the RED WoLF’s GHGE reduction system

**Algorithm 1:** GHGE Reduction Logic

---

```

input :  $A_{cur}, A_{pre}, CO_{2cur}, CO_{2pre}, PV_{cur}, PV_{pre}$ 
output:  $B_{con}, B_{inj}, C_{cur}, G_{con}, G_{inj}, H_{cur}$ 

1 begin
2   for each  $t$  do
3     read  $B_{lev}, H_{lev}, C_{lev}$ 
4     compute  $B_{dem}, H_{dem}, C_{dem}$  // See Eq. (3),(4)
5     for each  $t_{pred}$  do
6       read  $CO_{2pre}, A_{pre}, PV_{pre}$ 
7       compute  $CO_{2thr}$  // See Eq. (7)
8     read  $CO_{2cur}, A_{cur}, PV_{cur}$ 
9     if  $CO_{2cur} \geq CO_{2thr}$  &  $A_{cur} \geq PV_{cur}$  then
10       $\alpha \leftarrow A_{cur} - PV_{cur}$  // Missing PV power to cover appliances' demand
11       $B_{con} \leftarrow \min(B_{lev}, \alpha, B_{I_{max}})$ 
12       $G_{con} \leftarrow \min(\alpha - B_{con}, D_{I_{max}})$ 
13     else if  $CO_{2cur} \geq CO_{2thr}$  &  $A_{cur} < PV_{cur}$  then
14       $\beta \leftarrow PV_{cur} - A_{cur}$  // Remaining PV power after covering appliances' demand
15      if  $\beta < C_{dem}$  then
16         $C_{cur} \leftarrow \beta \times Heavi(C_{set} - C_{lev})$ 
17      else if  $\beta \geq C_{dem}$  &  $\beta < C_{dem} + H_{dem}$  then
18         $C_{cur} \leftarrow C_{dem}$ 
19         $H_{cur} \leftarrow (\beta - C_{dem}) \times Heavi(H_{set} - H_{lev})$ 
20      else if  $\beta \geq C_{dem} + H_{dem}$  &  $\beta < C_{dem} + H_{dem} + B_{dem}$  then
21         $C_{cur} \leftarrow C_{dem}$ 
22         $H_{cur} \leftarrow H_{dem}$ 
23         $B_{inj} \leftarrow \min((\beta - C_{dem} - H_{dem}), B_{I_{max}}) \times Heavi(B_C - B_{lev})$ 
24      else
25         $C_{cur} \leftarrow C_{dem}$ 
26         $H_{cur} \leftarrow H_{dem}$ 
27         $B_{inj} \leftarrow B_{dem}$ 
28         $G_{inj} \leftarrow \beta - (C_{cur} + H_{cur} + B_{con})$ 
29     else
30       $D_{I_{max}APV} \leftarrow D_{I_{max}} + (PV_{cur} - A_{cur})$ 
31       $B_{inj} \leftarrow \min(B_{dem}, D_{I_{max}APV} \times Heavi(B_C - B_{lev}))$ 
32       $H_{cur} \leftarrow \min(H_{dem}, (D_{I_{max}APV} - B_{inj}) \times Heavi(H_{set} - H_{lev}))$ 
33       $C_{cur} \leftarrow \min(C_{dem}, (D_{I_{max}APV} - (B_{inj} + H_{cur})) \times Heavi(C_{set} - C_{lev}))$ 
34       $P_{bal} \leftarrow A_{cur} - PV_{cur} + C_{cur} + H_{cur} + B_{inj}$ 
35      if  $P_{bal} \geq 0$  then
36         $G_{con} \leftarrow P_{bal}$ 
37      else
38         $G_{inj} \leftarrow -P_{bal}$ 

```

---

### 163 3.3. GHGE reduction logic

164 Based on the computed threshold, a logic is applied to decide which equipment need to be charged (or  
165 not) depending on the threshold value, but not only, it also depends on current PV production, the current  
166 demands of the storage heater, cylinder, battery, and so forth. Algorithm 1 provides the applied logic, which  
167 is run based on a two time intervals (see rows 2 and 3 in Algorithm 1), namely: (i) every  $t_{pred}$  (every hour  
168 in our case), the  $CO_{2thr}$  is computed based on  $A_{pre}$  and  $PV_{pre}$ ; (ii) every  $t$  (every minute in our case), the  
169 program monitors the current input values in order to perform the following logic:

- 170 • *Case 1 (row 9 to 11 in Algorithm 1)*: when the current grid CO<sub>2</sub> level ( $CO_{2cur}$ ) is higher than the  
171 CO<sub>2</sub> threshold ( $CO_{2thr}$ ), and that the PV production is not sufficient to supply the home appliances,  
172 energy from the battery (if any) is consumed, and then (if not sufficient) from the grid;
- 173 • *Case 2 (row 12 to 27)*: if the PV production is sufficient to supply the appliance power demand, the  
174 extra power (if any) is used to charge the thermal storage reservoirs (cylinder, then heaters), and then  
175 (if extra power still available) the battery. If some extra power is still available, it is then re-injected  
176 to the grid;
- 177 • *Case 3 (row 28 to 36)*: if CO<sub>2</sub> is lower than  $CO_{2thr}$ , everything is charged (to the extent possible) by  
178 drawing power from the grid if PV is not sufficient to cover the demand.

179 In the next section, the proposed RED WoLF’s GHGE reduction system is evaluated based on real-life  
180 datasets.

## 181 4. Experiments

182 In order to evaluate the benefits from implementing our proposal, three distinct scenarios have been  
183 analyzed and compared, as summarized in Figure 5:

- 184 A. *PV*: it consists of a single home fitted with PV array. Energy is consumed, first and foremost, from  
185 PV (when possible), otherwise from the grid. Note that the storage heaters and the water cylinder  
186 are considered as loads and storage units without optimization (i.e., charging at a given point in time,  
187 regardless of the CO<sub>2</sub> level or energy price);
- 188 B. *PV & battery*: it consists of a single home fitted with PV system and a battery. Energy is consumed,  
189 first and foremost, from PV array (when possible), then from the battery (when possible), otherwise from  
190 the grid. As before, storage heaters and a water cylinder are considered as loads and storage without  
191 optimization yet;

192 C. *PV & battery & RED WoLF*: it consists of a single home fitted with PV arrays, a battery and thermal  
 193 storage reservoirs (heaters and water cylinders). Unlike the previous two scenarios, thermal storage  
 194 reservoirs are taken into account, along with the battery, into the optimization process. Energy is  
 195 consumed, first and foremost, from PV arrays (when possible), then from the battery (when possible),  
 196 otherwise from the grid.

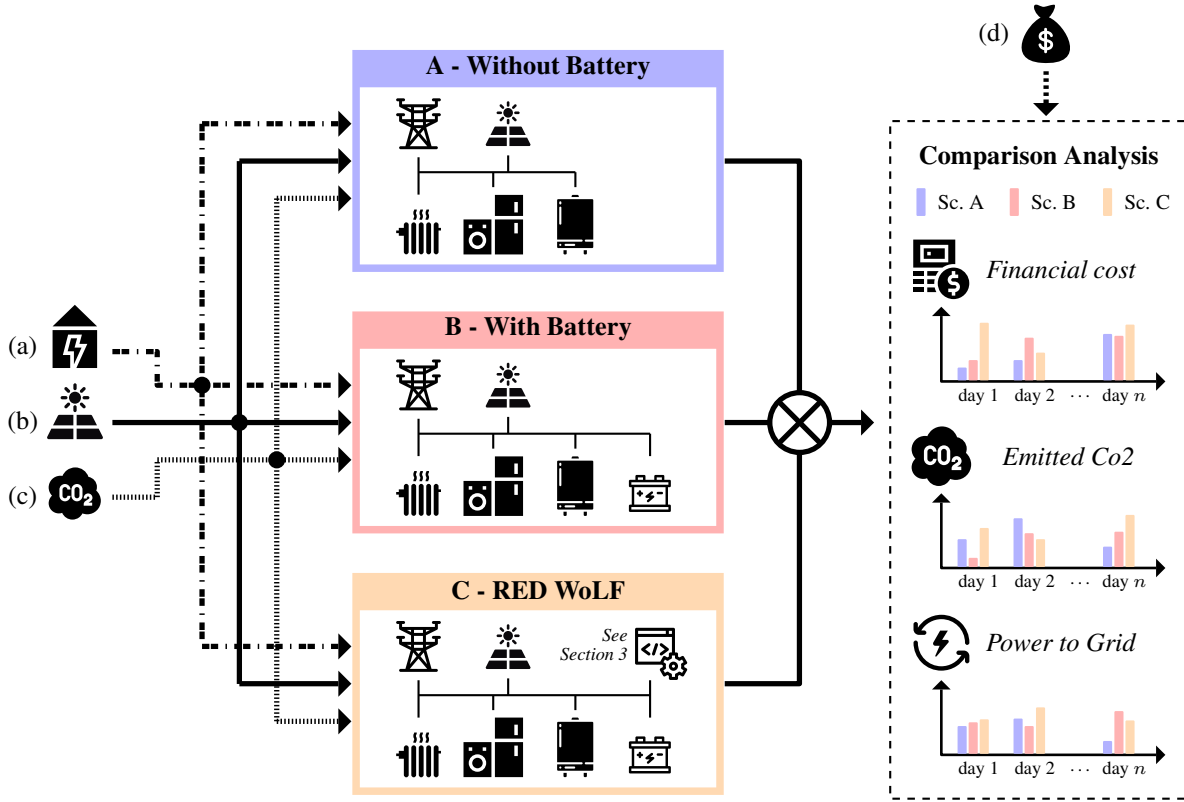

Figure 5: Benchmarking study to evaluate the benefits of the RED WoLF system/algorithm

197 Figure 5 provides a graphical overview of both the inputs and outputs of our study. In this respect, a  
 198 distinction has to be drawn between inputs needed to feed the proposed system/algorithm, namely inputs  
 199 (a) house electricity consumption, (b) electricity produced by PV arrays, (c) grid-related CO<sub>2</sub>, and an input  
 200 not needed to run the algorithm but used for comparison purposes, namely (d) electricity price. Regarding  
 201 the performance indicators considered, three indicators are defined:

- 202 1. *CO<sub>2</sub> Emission (gCO<sub>2</sub>/kWh)*: corresponds to the amount of grams of CO<sub>2</sub> (per kWh) emitted to  
 203 produce the electrical energy consumed by the house (i.e., energy from the grid);
- 204 2. *Financial cost (euros)*: corresponds to the electricity bill related to the energy consumed from the grid;

205 3. *Power to Grid (kW)*: corresponds to the algorithm’s ability to maximize PV self-consumption.

206 The experimental setup (incl., datasets used as inputs of the carried out experiments) is detailed in  
 207 section 4.1. Experimental results are presented and discussed in section 4.2. Finally, a sensitivity analysis  
 208 of the impact of the battery size on the overall system performance is carried out in section 4.3.

209 4.1. *Experimental Setup*

210 In the following, the four input data sources briefly mentioned previously – *i.e.* (a), (b), (c), (d) in  
 211 Figure 5 – are further detailed in this section.

212 *Home consumption (a)*: several scientific datasets can be found in the literature, as reported in (Monacchi  
 213 et al., 2014). In this study, two of them, namely the UKDALE (UK Domestic Appliance-Level Electricity)  
 214 for UK-related experiments and IHEPCDS (Individual Household Electric Power Consumption Data Set)  
 215 for French-related ones, are considered (Table 2 provides further details about those datasets). These two  
 216 datasets have been selected and are of interest for us because (i) these are popular benchmark datasets  
 217 in the housing sector; and (ii) as part of the RED WoLF project, pilots located in these two countries  
 218 are currently being set up. Furthermore, choosing these two countries is interesting from an experimental  
 219 viewpoint, as they have different ways of generating electricity (mostly nuclear-based in France, while UK  
 220 mostly uses natural gas), which makes it possible to evaluate the performance of the proposed algorithm  
 221 under different grid conditions. The October month is considered in this study. Figure 6(a) gives insight  
 222 into the energy consumption patterns over a day from these two datasets, showing that a similar trend is  
 223 observed, corresponding to period of times where inhabitants are at home.

Table 2: Input dataset-related information

Input dataset	Location	Name	Period	URL
(a) Home consumption	UK	UKDALE	October	(NSD, 2021)
	France	IHEPCDS	October	
(b) PV production	UK	N/A	October	(NRE, 2020)
	France	N/A	October	(PVG, 2020)
(c) Grid-related CO <sub>2</sub>	UK	N/A	October	(NGE, 2021)
	France	N/A	October	(RTE, 2021)
(d) Energy price	UK	N/A	N/A	(STA, 2021)
	France	N/A	N/A	

224 *PV production (b)*: No platform providing real-time PV production data in France exists, to the best  
 225 of our knowledge, while in UK the NREL (National Renewable Energy Laboratory) web platform provides

226 access to both historical and predicted PV datasets. Noentless, a simulator developed by the European  
 227 Commission (*cf.*, Table 2) shows that there is a difference of 15.4% between UK and France (in favour of  
 228 France). As a result, the PV production dataset obtained for UK via the NREL web platform was increased  
 229 of 15.4% for the French experiments (see Figure 6(b)).

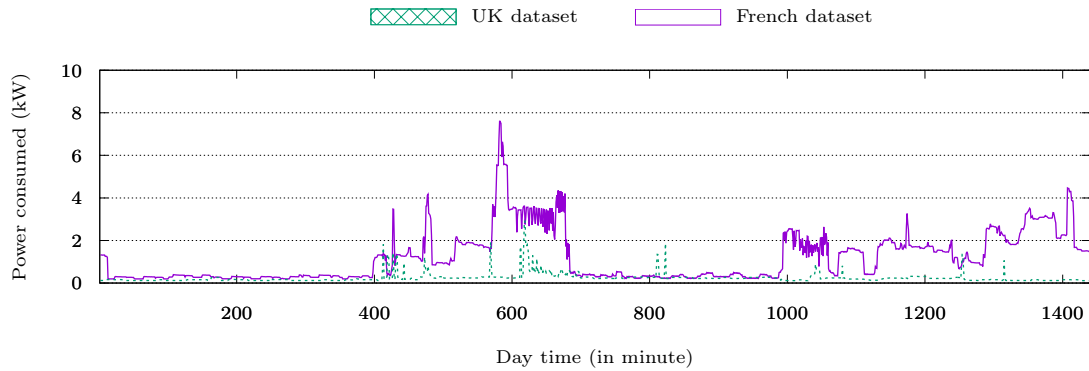

(a) Input: Home power consumption

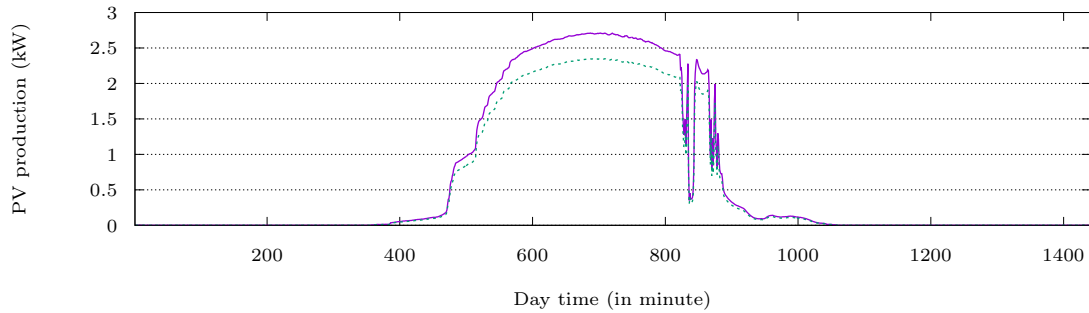

(b) Input: PV power production

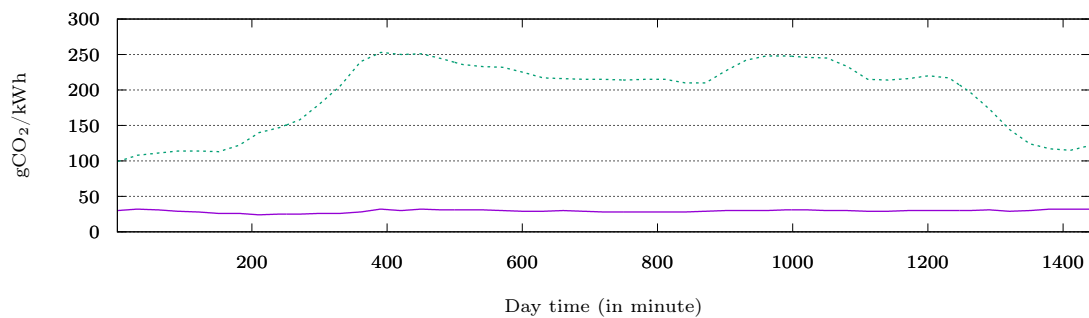

(c) Input: CO<sub>2</sub> load emitted by the grid

Figure 6: Input datasets

230 *Grid-related CO<sub>2</sub> (c)*: two distinct web platforms providing APIs (standing for: Application Program-  
 231 ming Interface) to access carbon intensity variation of the FR and UK grids were used, namely the RTE

232 APIs (Réseau de Transport d'électricité) for France and the carbon intensity website for UK (*cf.*, Table 2).  
233 Figure 6(c) gives insight into the carbon intensity variation patterns over a day for the two considered coun-  
234 tries. It can be observed that the energy is much less greener in UK than in France (3 to 5 times less green),  
235 adding that UK is subject to significant CO<sub>2</sub> variations compared with France. This can be explained by the  
236 fact that, in France, most electricity is produced by nuclear power plants. Obviously, such political factors  
237 have a direct impact on the proposed solutions, and subsequently on the decisions taken, whether at the  
238 grid, microgrid, or nanogrid levels.

239 *Energy price (d)*: even though prices could vary during the day, a fixed average electricity price obtained  
240 from Eurostat<sup>2</sup> is considered, namely 0.2122 and 0.1765 euros per kWh in UK and France respectively.

241 Finally, let us note that a battery of capacity ( $B_C$ ) 7 kWh and of maximum power intake ( $B_{I_{max}}$ ) of  
242 14 kW is considered for the experiments, which corresponds to a mid-range battery product on the market.  
243 However, a more in-depth analysis of the impact of the battery size impact on the overall system performance  
244 is carried out in section 4.3.

## 245 4.2. Experimental Results

246 The presentation of the experimental results is divided into two parts. In section 4.2.1, results for a 1-day  
247 timeframe are presented, while results for a 1-month timeframe are analyzed in section 4.2.2.

### 248 4.2.1. 1-day analysis

249 Figures 7(a) and 7(c) give insight into the power exchanges occurring at a given day between the grid,  
250 the home appliances, the battery and thermal storage reservoirs, and the PV units, with regard to the three  
251 considered scenarios. For the conducted experiments, let us note that the sum of the power supplied to  
252 indoor equipment (incl., appliances, battery and thermal storage reservoirs), minus the power generated by  
253 PV must not exceed the limit fixed by the electricity provider, which is set to 9 kW. Looking at results in  
254 Figures 7(a) and 7(c), an interesting observation is that, for this specific day, less power is re-injected to the  
255 grid when using our system (scenario C) compared with scenarios A and B (see curve denoted by *-Power to*  
256 *grid*). Indeed, when looking at the first scenario, almost all the energy generated by PV is re-injected (see  
257 period 9h to 16h), while in our system, it only starts around 12:30. Although this observation is only valid  
258 for this specific day, it is worth noting it as the following consideration is made: the higher the amount of  
259 energy re-injected to the grid, the less this energy source is valued at the local level. This has a twofold  
260 consequence: (1) the inhabitant does not take advantage of her/his own energy, which goes against one of the  
261 ecological principles (namely "shop locally" (Benyus, 1997)), adding that she/he remains grid-dependent<sup>3</sup>,

---

<sup>2</sup><https://fr.statista.com/infographie/11825/comparaison-cout-electricite-en-europe/>

<sup>3</sup>Grid independency is a sustainability measure which is usually used to see how the house will perform if there will be no energy supply from the main grid (Akter et al., 2017).



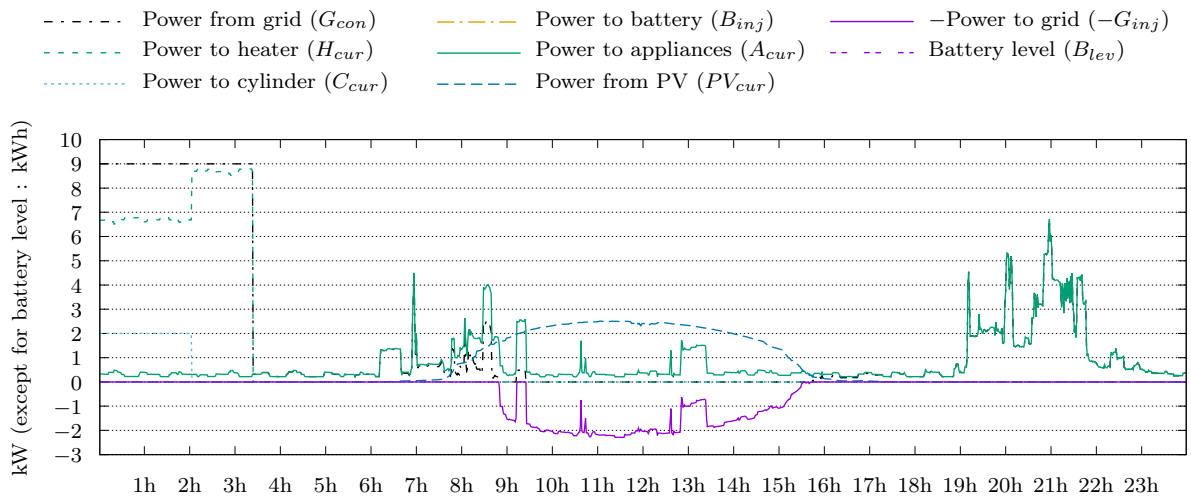

(a) Scenario A - Without Battery

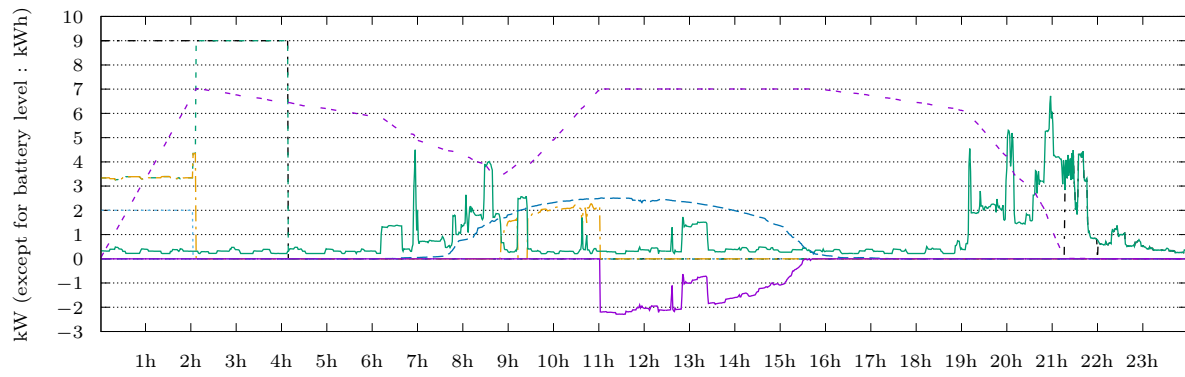

(b) Scenario B - With Battery

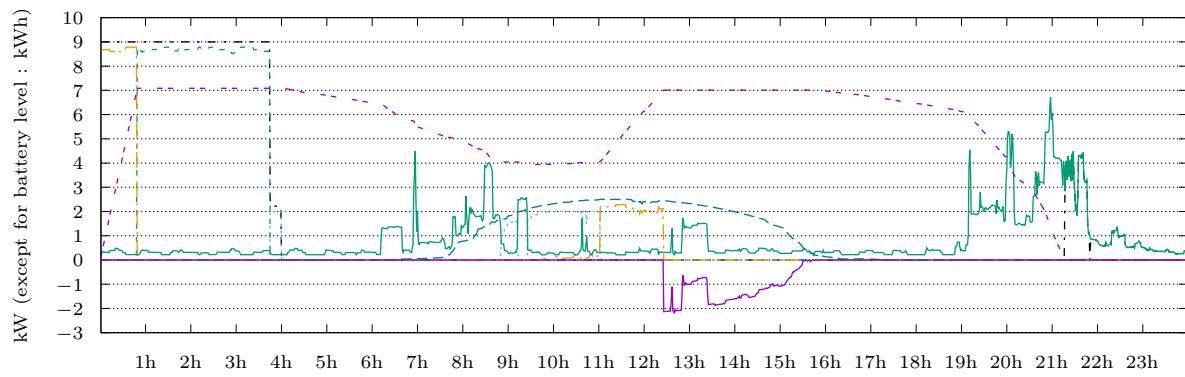

(c) Scenario C - Red WoLF

Figure 7: 1-day analysis regarding the three scenarios compared in our experiments

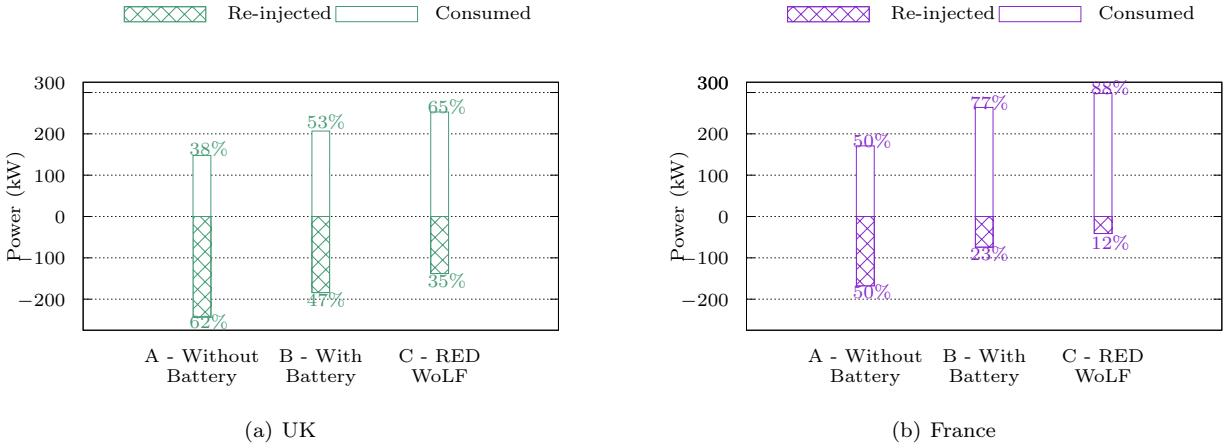

Figure 8: Power to Grid

262 and (2) energy losses will likely occur during energy transmission phases on the grid. Having said that, it  
 263 cannot be concluded at this stage (i.e., based on a single day) whether our approach leads to better results  
 264 on long term runs. As a result, a longer period of time is studied in the next section.

#### 265 4.2.2. 1-month analysis

266 In the following, a full month (October) is analyzed with respect to the three performance indicators  
 267 introduced in Figure 5.

268 *Power to Grid:* Figures 8(a) and 8(b) provide insight into how much local energy (i.e., produced by PV)  
 269 is re-injected to the grid (in the UK and French cases), or locally consumed. Let us note that the sum of  
 270 the re-injected and locally consumed energies is equal to the total amount of energy produced by PV. For  
 271 example, considering scenario B in Figures 8(a), 53% refers to the part of the energy generated by PV that  
 272 is locally consumed, while the remaining 47% is re-injected to the grid. Having in mind that the objective of  
 273 RED WoLF is to maximize local energy consumption (as discussed in the section 4.2.1), it can be noted, as  
 274 a first comment of Figures 8(a) and 8(b), that more than half of the energy produced locally is re-injected to  
 275 the grid in scenario A ("Without battery"), while this effect is significantly reduced when adding a battery  
 276 and/or thermal storage reservoirs to the infrastructure (scenarios B and C). Indeed, the implementation of  
 277 storage units enables to mitigate the re-injection of energy produced locally to the grid up to 23% in France,  
 278 against 47% in the UK. When using the RED WoLF's GHGE reduction system, this reduction goes down  
 279 to 12% and 35% respectively in France and UK. This difference between both countries is mainly due to  
 280 the energy consumption patterns, as in the French house, the consumption is higher than in the UK's house  
 281 (821 kWh against 269 kWh), adding that the solar energy can be almost fully used locally with the proposed  
 282 system/algorithm (i.e., scenario C). Furthermore, by examining the house energy consumption patterns (see  
 283 Figure 6(a)), it can be seen that the energy produced by PV takes mainly place outside daylight periods,

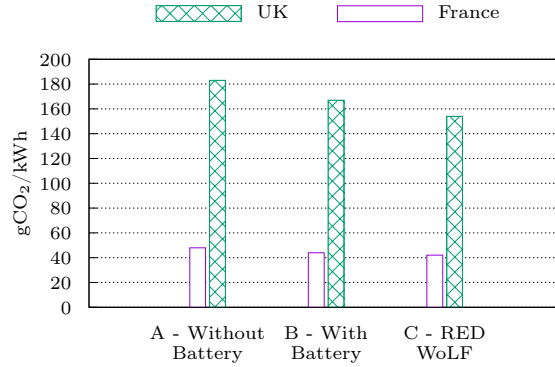

Figure 9: Emitted CO<sub>2</sub>

284 which is why a smart procedure for optimizing the use of the storage units based on inhabitant needs and  
 285 habits is relevant.

286 *CO<sub>2</sub> Emission:* Let remind ourselves that this metric is the most important from a RED WoLF project  
 287 perspective, as the main goal of the project is to increase renewables' usage and reduce CO<sub>2</sub> emission.  
 288 Figure 9 gives insight into the experimental results related to the three considered scenarios (A, B, C). It  
 289 can be observed that a similar trend is obtained, with a decrease of around 9% between scenarios A and B  
 290 (i.e., without battery *vs.* with battery), and around 7% between scenarios B and C (i.e., with battery *vs.*  
 291 RED WoLF). These results show to what extent it could be beneficial to add some "smart" (software) logic  
 292 to battery products available on the market. Indeed, up to 16% of gCO<sub>2</sub>/kWh could be saved using the  
 293 proposed solution compared with a basic installation integrating only PV. However, it should be noted that  
 294 such a reduction could be more or less significant according to the country. In our case (see Figure 9), the  
 295 monthly gain for the UK house is almost four times higher than for the French one (29000 gCO<sub>2</sub>/kWh *vs.*  
 296  $\approx$  5500 gCO<sub>2</sub>/kWh). This somehow proves that the actions to be taken to in-house GHGE not only required  
 297 smart solutions at the house level, but also appropriate political decisions and measures, which is obviously  
 298 out of scope of this study.

299 *Financial Cost:* If the use of "smart" storage system is interesting from an environmental viewpoint,  
 300 its societal impact should not be neglected by analyzing the cost of the implemented solution. Figure 10  
 301 gives insight into the electricity bill resulting from each solution/scenario. It can be observed that the bill is  
 302 reduced by around 10% percent in the UK case and 7% in the French one when the RED WoLF system is  
 303 used (i.e., scenario A *vs.* C). When comparing scenarios B and C, RED WoLF makes it possible to reduce  
 304 the monthly bill by 12 euros for the UK case, and 3 euros for the French one. A simple explanation is that  
 305 the optimization of local energy usage results in price-free energy. Compared to the current literature studies  
 306 (*cf.*, section 2) that consider both CO<sub>2</sub> and energy price in their optimization process, the proposed algorithm  
 307 allows to implicitly optimize both criteria (CO<sub>2</sub> and price). Given that the home energy consumption over

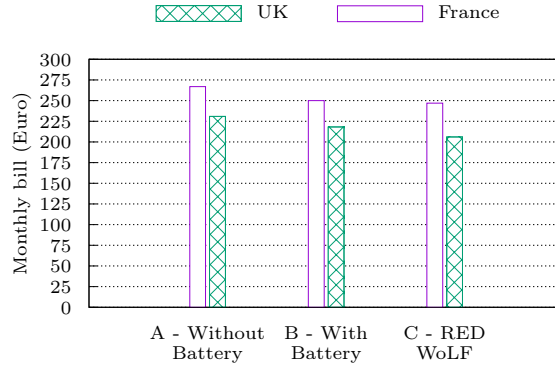

Figure 10: Electricity bill

308 the October month is of 821 kWh and 269 kWh respectively in France and UK, and that the electricity price  
 309 in each country is different, it results in a saving of 0.38 euros per 100 kWh consumed in France, while in UK  
 310 it reaches 1.46 euros per 100 kWh consumed. This is a non-negligible saving from a UK family viewpoint,  
 311 while in France it is less significant, which confirms that it not that easy to come up with a “universal” GHGE  
 312 reduction system proposal, as many external factors at the national level (incl., political, technological and  
 313 societal ones) have direct impact on the efficiency of the proposed system. For example, in our case, just  
 314 looking at Figure 6(c), it can quickly be noted that the RED WoLF algorithm will be less effective in France  
 315 than in UK, as the CO<sub>2</sub> signal in France is both lower (average of 30 in France against 200 in UK) and  
 316 subject to less variations (variation of 5 gCO<sub>2</sub>/kWh in France against 100 gCO<sub>2</sub>/kWh in UK).

### 317 4.3. Battery Capacity Analysis

318 The previous section pointed out the fact that an optimized storage system makes it possible the reduction  
 319 of GHGE, while reducing the electricity bill (even if the saving is more subtle in France than in UK). This  
 320 analysis was done considering a battery capacity ( $B_C$ ) of 7 kWh and a maximum power intake ( $B_{I_{max}}$ ) of  
 321 14 kW. In this section, the goal is now to analyze the impact of these two parameters on the overall system  
 322 performance when using the RED WoLF’s GHGE reduction system. To this end, four types of batteries  
 323 available on the market are considered, as synthesized in Table 3. In what follows the results of this analysis  
 324 are discussed, but, unlike the previous section, results are now presented as an “improvement ratio” between  
 325 storage-based solutions (i.e., scenarios B and C) with a reference scenario that corresponds to a infrastructure  
 326 without battery (i.e., scenario A).

327 Figure 11 shows the improvement ratio related to the energy consumed locally. For clarification purposes,  
 328 and to make sure that the “improvement ratio” has been correctly understood, let us consider the example  
 329 of the LG6.5 battery in Figure 11(a): the result tells that scenario B is 23% more efficient than scenario A  
 330 (which is considered as the reference), while scenario C is 43% more efficient than scenario A. Overall, when

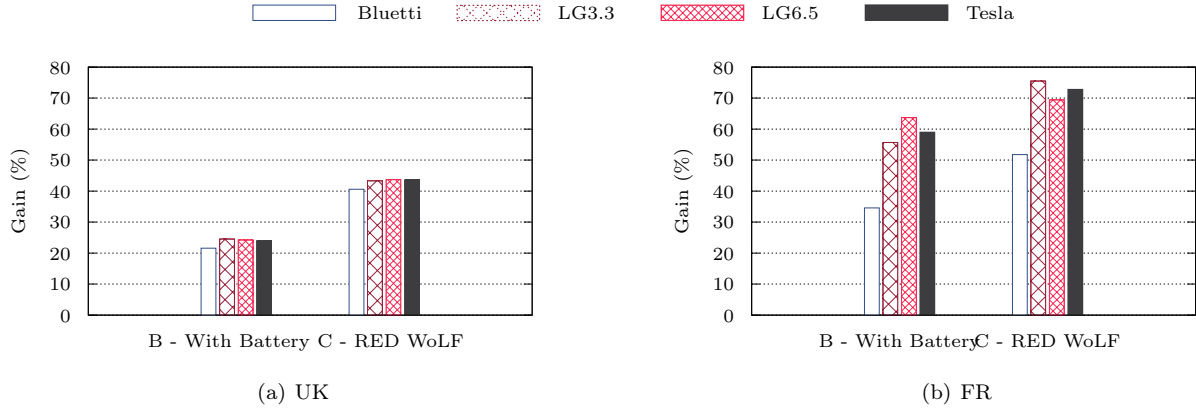

Figure 11: Improvement of local energy consumption

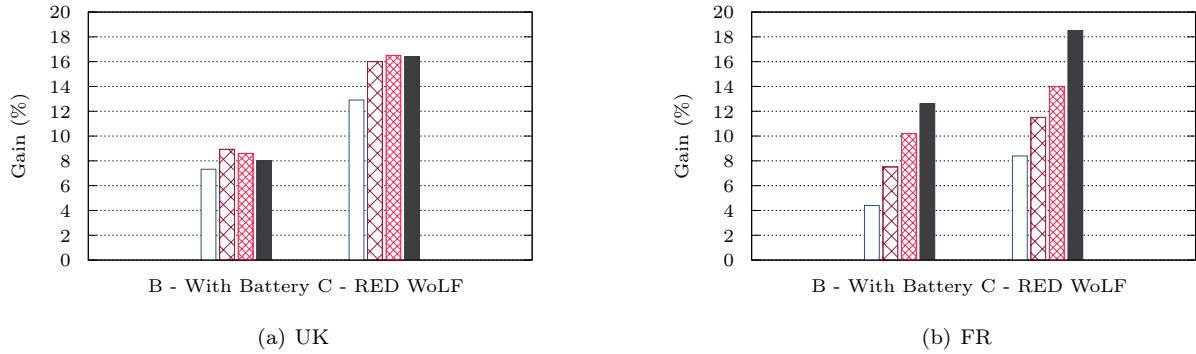

Figure 12: Improvement of footprint impact (reduction of CO<sub>2</sub>)

Table 3: Battery products (from the market) analyzed

	Bluetti	LG3.3	LG6.5	Tesla
$B_{I_{max}}$ (kW)	1	3.3	4.2	7
$B_C$ (kWh)	1.5	3.3	6.5	13.5

331 looking at all results in Figures 11(a) and 11(b), it can be concluded that, regardless of the battery size and  
 332 whether a smart software layer is or not added, the use of storage units with a PV infrastructure is always  
 333 beneficial (in the UK and France), reaching up to 75% of improvement in the French case with LG3.3. It  
 334 can also be observed that the size of the battery has a lower impact in the UK case compared with the  
 335 French one, which is due to the fact that the house electricity consumption is lower in UK. Given this, higher  
 336 battery capacities are more beneficial in the French case. Furthermore, it can also be seen that, in France,  
 337 RED WoLF provides the best results with the LG3.3 battery, which can be explained by the fact that the  
 338 larger the battery capacity (e.g., LG6.5), the longer the charging times, which make the battery unusable

339 during those periods, therefore impacting on the optimization performance. All in all, Figures 11(a) and  
 340 11(b) show that RED WoLF makes it possible to optimize the use of local energy sources with around 20%  
 341 of improvement in UK between scenarios B and C, while this improvement ranges between 7% and 20% in  
 342 France.

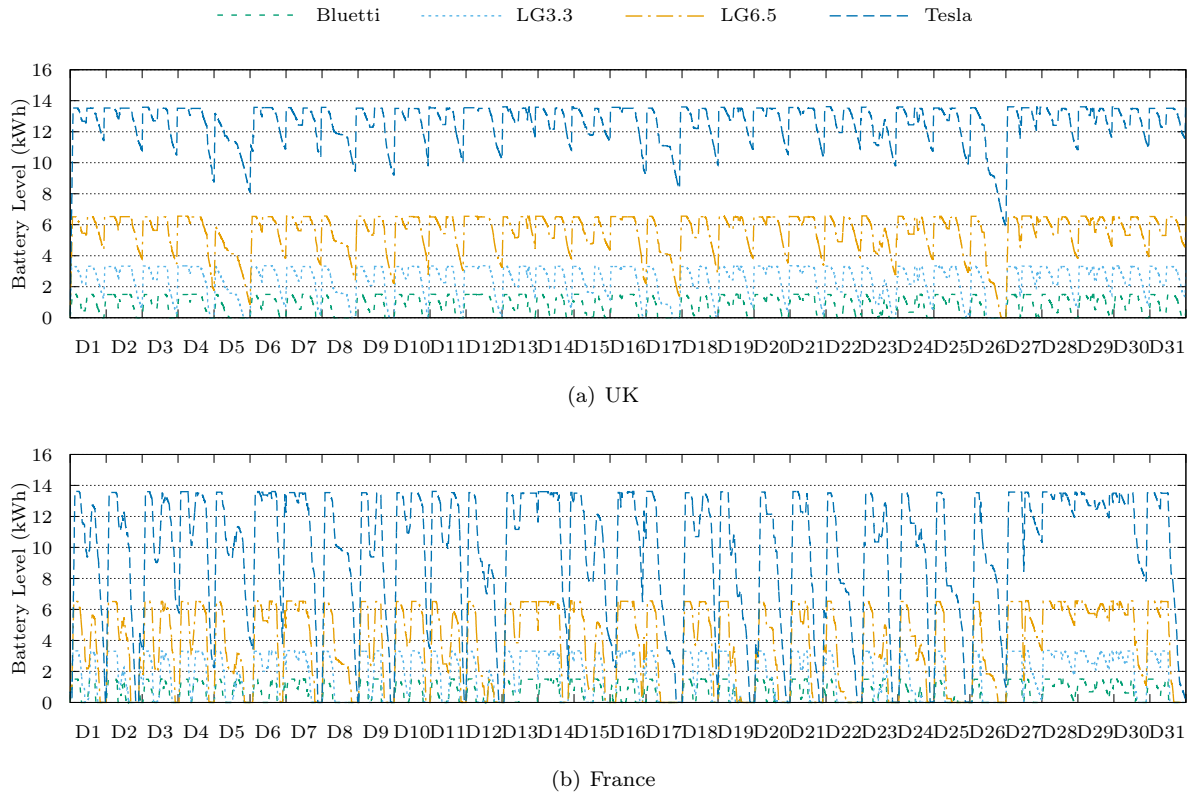

Figure 13: Battery Level in scenario C (RED WoLF)

343 Figure 12 presents the improvement ratio, referring in this case to the extent to which GHGE are reduced.  
 344 In the UK case, the following observation can be made: (i) RED WoLF makes it possible the reduction of  
 345 emissions of around 8%, and (ii) there is no much difference in results when using different battery sizes.  
 346 The reasons are the same as before, i.e. a lower house energy consumption than in the French house. Thus,  
 347 above a certain battery size, the quantity of energy stored day by day in the battery will not be consumed.  
 348 To better understand this effect, let us have a look at the battery levels over the whole October month,  
 349 respectively in the UK case (see Figure 13(a)) and in the French one (see Figure 13(b)). It can be seen that  
 350 the Tesla battery in the UK case remains almost full (it does not discharge much), while in the French case all  
 351 batteries are fully discharged at the end of the day. This is why using high capacity batteries leads to better  
 352 results in France (5% of improvement between scenarios C and B). One more comment about Figure 12(a) is  
 353 that, when looking at scenario B, it can be observed a gradual increase in carbon emission for the two largest

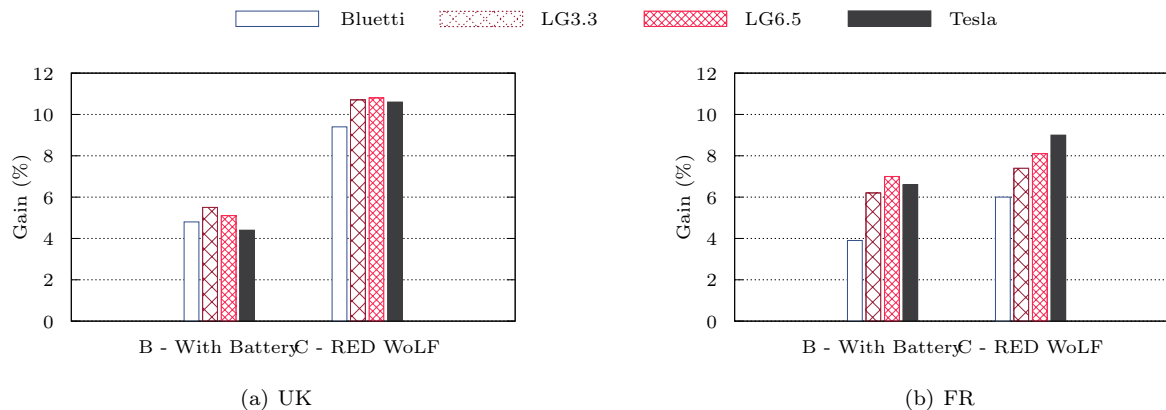

Figure 14: Financial cost improvement

354 batteries. The reason for this is that, since there is no smart software layer, the battery charging is done  
 355 over a single period of time and is not broken down into optimal charging periods (i.e., when the electricity  
 356 is low carbon), as is the case with the RED WoLF algorithm. This may result in charging the battery during  
 357 high carbon electricity periods, which will have the following consequence: the larger the battery size, the  
 358 higher the amount of dirty electricity stored in the battery.

359 The impact of different battery sizes on the family budget is shown in Figure 14. This impact is tightly  
 360 coupled with the the power to grid metric, as the higher the amount of PV-generated energy consumed  
 361 locally, the lower the electricity bill. In UK, the proposed system makes it possible the reduction of the bill  
 362 of about 10% compared with the reference scenario (i.e., without battery), while in France this reduction is  
 363 about 8%.

364 As a concluding remark, these results prove that there is a benefit of combining batteries, thermal storage-  
 365 like units, with additional software solutions, and this in three respects: (i) it contributes to increase the  
 366 consumption of energy produced locally, thus making the house increasingly autonomous and self-sufficient  
 367 energetically speaking; (ii) it contributes to reduce GHGE; and (iii) it contributes to reduce the electricity  
 368 bill. This study also shows that the LG3.3 battery is sufficient in the UK case, while this is not the case in  
 369 the French one. Indeed, the Tesla battery provides better results in terms of GHGE, but its high purchase  
 370 price (due to its high storage capacity) has a non negligible impact on the total budget.

## 371 5. Discussion

372 This work is part of the global effort that each sector of activity is asked to reduce GHGE by 20% by 2025,  
 373 and by 40% to 50% by 2030 in order to comply with the Paris Climate Agreements. The political objective  
 374 is clearly focused on GHGE without specifying constraints on adaptation costs. For example, in France,  
 375 the economic impacts inherent to the new "Réglementation Environnementale 2020" standard (RE2, 2020)

376 on decarbonisation applied to french dwellings are yet difficult to quantify. In our opinion, this is a bold  
377 but necessary gamble to move the lines in the construction, use and deconstruction of housing units. This  
378 study, and more generally the Interreg NWE RED WoLF project within which the research presented in this  
379 paper is developed, aligned with this move and does not yet take into account economical aspects, whether  
380 in terms of costs incurred by the system installation, or the dynamics in electricity prices. For the latter  
381 economical aspect (i.e., dynamics in prices), it can nonetheless be noted that the electricity CO<sub>2</sub> evolution  
382 is often correlated to the price evolution, so looking for low-carbon periods usually leads to lower the overall  
383 electricity bill, as was the case in the experiments carried out in section 4. Regarding the former aspect (i.e.,  
384 system installation cost), the RED WoLF system can be approximately estimated at 6k€(±3k€) depending  
385 on the region, size of PV arrays, and the quality of the selected products/vendors, the main constituents  
386 and installation costs being (i) solar panels: about 800€/kW; (ii) battery: from 500-2000€/kWh; (iii)  
387 water boiler: between 500-1500€; (iv) storage heaters: between 200 and 1000€for around 15 kWh, and (v)  
388 microcontroller: about one hundred euros (e.g., arduino). All this to say that it should not be neglected that  
389 costly solutions can hamper the adoption of GHGE reduction systems by inhabitants, but this is not yet  
390 part of the research work presented this paper. To pursue the previous discussion about forthcoming moves  
391 and agreements envisioning the decarbonisation of electricity (e.g., Paris agreement plans to decarbonise it  
392 from 0.63 kg eCO<sub>2</sub>/kWh in 2015 to 0.200 kg eCO<sub>2</sub>/kWh by 2030), one may wonder whether RED WoLF-like  
393 systems will not be "obsolete" in a couple of years, as electricity decarbonisation will *de facto* lead to house  
394 decarbonisation. However, the figures given for 2030 are much higher for French production at present and  
395 globally equivalent to that of the UK. The execution of the RED WoLF-like algorithms show that electricity  
396 with less carbon than that produced worldwide brings a notable reduction and would be more interesting to  
397 apply outside Europe or in countries like Poland where coal is still widely used for electricity production.

398 In terms of next steps, our research aims at comparing the RED WoLF algorithm with other state-of-the-  
399 art algorithms, even though it is never a straightforward process to carry out such a comparison analysis, as  
400 the inputs and objectives functions underlying existing optimization algorithms often differ from one another  
401 (cf., section 2.2). For example, very few optimization functions from the literature do consider thermal storage  
402 equipment as storage units in their objective functions (McKenna et al. (2019)). It is therefore needed to  
403 carry out some adaptation steps to be able to compare our approche with existing ones. In this respect, a  
404 research collaboration with Dr. Katie McConky (Rochester Institute of Technology Industrial and Systems  
405 Engineering), who has proposed the optimization function presented in (Olivieri and McConky, 2020), has  
406 been initiated, whose results will be presented in a forthcoming paper.



## 407 6. Conclusion, Limitations & Perspectives

### 408 6.1. Conclusion

409 The residential sector accounts for a further 1/4 of EU final energy consumption, and for 30% of the  
410 total green house gas emissions. Within this context, the development of green energies in Europe comes  
411 with technological advances, cost decreases, process industrialisation, and efficiency improvement. Having  
412 said that, there is still work left to optimise the use of technologies such as PV, storage units (e.g., batteries)  
413 and so forth. This is the objective of the ongoing Interreg NWE RED WoLD project, which aims to increase  
414 renewables' usage and reduce CO<sub>2</sub> emission for homes with PV.

415 This research work presents a version of the RED WoLF system and the underlying GHGE reduction  
416 algorithm. Before developing technical solutions to achieve such a reduction, it is necessary to understand  
417 the benefit of such optimized energy systems. In this respect, first experimental studies carried out in this  
418 article, which rely on real-life input datasets, tend to show potential benefits that can be achieved. Overall,  
419 the conducted experiments, which rely on real-life datasets from UK and France, show that a "smart"  
420 (optimized) storage system makes it possible the reduction of about 5% (in France) of the GHGE compared  
421 with a off-the-shelf battery solution. To put the potential of this benefit into perspective, let us highlight  
422 the fact that the rehabilitation effort made by Paris over the last 6 years for the residential sector has led  
423 to a reduction of the GHGE of 25%<sup>4</sup>. These rehabilitation costs, yet necessary, are very high compared to  
424 the integration of RED WoLF-like solutions that lead to immediate gain (more than 5% in our case). Let us  
425 point out the fact that several real-life pilots are currently being setting up through the RED WoLF project,  
426 in France, UK and Ireland. Furthermore, the initial version of the RED WoLF algorithm (presented in this  
427 paper) is going to be improved in both iterative and recursive manner, both based on possible difficulties  
428 faced in real-life pilot settings and on innovative ideas, as discussed in the next section.

### 429 6.2. Research Limitations & Perspectives

430 As previously stated, the RED WoLF algorithm presented could be enhanced in several respects:

- 431 • first, one may wonder to what extent the implemented ICT (Information and Communication Tech-  
432 nology) architecture impacts on the overall GHGE, and this would be a fair question (may be running  
433 a smart logic on the Cloud could result in high GHGE). In this respect, research will be carried out to  
434 estimate such impact and take it into account in future versions of the algorithm;
- 435 • second, it can be envisioned to combine several storage units (e.g., several batteries) into a single house  
436 in order to both (i) further optimize the storage and re-use of energy, as a battery in charging mode

---

<sup>4</sup><https://www.apc-paris.com/actualite/bilan-carbone-2018-paris-est-sur-bon-chemin>

437 cannot be used to power appliances; (ii) propose innovative local electricity markets for the prosumer  
438 era (e.g., using blockchain), which could benefit from the proposed optimization system in the future;

- 439 • third, as previously discussed, other works in the field are multiplying in the literature, which could  
440 serve as benchmark studies for comparing RED WoLF with. The main challenge lies in the fact  
441 that the goals to be optimized often vary from one study to another (e.g., costs, energy mix, carbon  
442 emissions, electricity consumption), without speaking about the high heterogeneity in the input data  
443 sources. It could therefore be worth investigating a kind of generic (online) comparison framework  
444 to allow researchers to select various types of input data sources and performance indicators In this  
445 respect, collaborative work is underway with Rochester Institute of Technology Industrial and Systems  
446 Engineering, which could lead to a series of benchmarking studies and frameworks to be made available  
447 to the scientific community.

#### 448 **Acknowledgement**

449 This work has been supported by the European Regional Development Fund and Interreg NWE, project  
450 RED WoLF, project number NWE847.

451 Baek, S., Kim, S., 2020. Potential Effects of Vacuum Insulating Glazing Application for Reducing Greenhouse  
452 Gas Emission (GHGE) from Apartment Buildings in the Korean Capital Region. *Energies*. 13(11), 2828.  
453 <https://doi.org/10.3390/en13112828>.

454 Wang, N., Satola, D., Houlihan Wiberg, A., Liu, C., Gustavsen, A., 2020. Reduction strategies for greenhouse  
455 gas emissions from high-speed railway station buildings in a cold climate zone of China. *Sustainability*.  
456 12(5), 1704. <https://doi.org/10.3390/su12051704>.

457 Holdren, J. P., 2006. The energy innovation imperative: Addressing oil dependence, climate  
458 change, and other 21st century energy challenges. *Innov. Technol. Gov. Glob.* 1(2), 3-23.  
459 <https://doi.org/10.1162/itgg.2006.1.2.3>.

460 Blackburn, C., Harding, A., Moreno-Cruz, J., 2017. Toward deep-decarbonization: an energy-  
461 service system framework. *Current Sustainable/Renewable Energy Reports*. 4(4), 181-190.  
462 <https://doi.org/10.1007/s40518-017-0088-y>.

463 Lazarus, M., van Asselt, H., 2018. Fossil fuel supply and climate policy: exploring the road less taken.  
464 *Climatic Change*. 150, 1-13. <https://doi.org/10.1007/s10584-018-2266-3>.

465 Li, J., Zhang, Z., Shen, B., Gao, Z., Ma, D., Yue, P., Pan, J., 2020. The capacity allocation method  
466 of photovoltaic and energy storage hybrid system considering the whole life cycle. *J. Clean. Prod.* 275,  
467 122902. <https://doi.org/10.1016/j.jclepro.2020.122902>.

468 Lai, C. S., Locatelli, G., Pimm, A., Wu, X., Lai, L. L., 2020. A review on long-term electrical power system  
469 modeling with energy storage. *J. Clean. Prod.* 280, 124298. <https://doi.org/10.1016/j.jclepro.2020.124298>.

470 Dileep, G., 2020. A survey on smart grid technologies and applications. *Renew. Energy*, 146, 2589-2625.  
471 <https://doi.org/10.1016/j.renene.2019.08.092>.

472 Rahim, S., Javaid, N., Khan, R. D., Nawaz, N., Iqbal, M., 2019. A convex optimization based decentralized  
473 real-time energy management model with the optimal integration of microgrid in smart grid. *J. Clean.*  
474 *Prod.* 236, 117688. <https://doi.org/10.1016/j.jclepro.2019.117688>.

475 Wen, Q., Liu, G., Rao, Z., Liao, S., 2020. Applications, evaluations and supportive strategies of distributed  
476 energy systems: A review. *Energy Build.* 225, 110314. <https://doi.org/10.1016/j.enbuild.2020.110314>.

477 Mendes, D. L., Rabelo, R. A., Veloso, A. F., Rodrigues, J. J., dos Reis Junior, J. V., 2020. An adaptive  
478 data compression mechanism for smart meters considering a demand side management scenario. *J. Clean.*  
479 *Prod.* 255, 120190. <https://doi.org/10.1016/j.jclepro.2020.120190>.

480 Burmester, D., Rayudu, R., Seah, W., Akinyele, D., 2017. A review of nanogrid topologies and technologies.  
481 *Renew. Sustain. Energy Rev.* 67, 760-775. <https://doi.org/10.1016/j.rser.2016.09.073>.

482 Kalair, A. R., Abas, N., Hasan, Q. U., Seyedmahmoudian, M., Khan, N., 2020. Demand side man-  
483 agement in hybrid rooftop photovoltaic integrated smart nano grid. *J. Clean. Prod.* 258, 120747.  
484 <https://doi.org/10.1016/j.jclepro.2020.120747>.

485 Saleem, Y., Crespi, N., Rehmani, M. H., Copeland, R., 2019. Internet of things-aided smart grid: technolo-  
486 gies, architectures, applications, prototypes, and future research directions. *IEEE Access.* 7, 62962-63003.  
487 <https://doi.org/10.1109/ACCESS.2019.2913984>.

488 Xie, C., Wang, D., Lai, C. S., Wu, R., Wu, X., Lai, L. L., 2020. Optimal sizing of BESS in smart microgrid  
489 considering virtual energy storage system and high photovoltaic penetration. *J. Clean. Prod.* 281, 125308.  
490 <https://doi.org/10.1016/j.jclepro.2020.125308>.

491 Wu, W., Wang, H., Liu, Y., Huang, M., Blaabjerg, F., 2016. A dual-buck-boost AC/DC con-  
492 verter for DC nanogrid with three terminal outputs. *IEEE Trans. Ind. Electron.* 64 (1), 295-299.  
493 <https://doi.org/10.1109/TIE.2016.2598804>.

494 Sahin, E. S., Bayram, I. S., Koc, M., 2019. Demand side management opportunities, framework, and im-  
495 plications for sustainable development in resource-rich countries: Case study Qatar. *J. Clean. Prod.* 241,  
496 118332. <https://doi.org/10.1016/j.jclepro.2019.118332>.

497 Wu, X., Hu, X., Teng, Y., Qian, S., Cheng, R., 2017. Optimal integration of a hybrid solar-battery  
498 power source into smart home nanogrid with plug-in electric vehicle. *J. Power Sources*. 363, 277-283.  
499 <https://doi.org/10.1016/j.jpowsour.2017.07.086>.

500 Shamsirband, M., Salehi, J., Gazijahani, F. S., 2018. Decentralized trading of plug-in electric vehicle  
501 aggregation agents for optimal energy management of smart renewable penetrated microgrids with the aim  
502 of CO<sub>2</sub> emission reduction. *J. Clean. Prod.* 200, 622-640. <https://doi.org/10.1016/j.jclepro.2018.07.315>

503 Ahmed, M., Nawaz, A., Ahmed, M., Farooq, M. S., 2019. Decentralized Power Control Strategy in Microgrid  
504 for Smart Homes. *SGRE*. 10 (3), 43-53. <https://doi.org/10.4236/sgre.2019.103004>.

505 Tastan, M., 2019. Internet of things based smart energy management for smart home. *KSII Trans. Internet*  
506 *Inf. Syst.* 13 (6), 2781-2798. <https://doi.org/10.3837/tiis.2019.06.001>.

507 Marinakis, V., Doukas, H., 2018. An advanced IoT-based system for intelligent energy management in  
508 buildings. *Sensors*, 18 (2), 610. <https://doi.org/10.3390/s18020610>.

509 Ngarambe, J., Yun, G. Y., Santamouris, M., 2020. The use of artificial intelligence (AI) methods in the  
510 prediction of thermal comfort in buildings: energy implications of AI-based thermal comfort controls.  
511 *Energy Build.* 211, 109807. <https://doi.org/10.1016/j.enbuild.2020.109807>.

512 Goudarzi, S., Anisi, M. H., Kama, N., Doctor, F., Soleymani, S. A., Sangaiah, A. K., 2019. Predictive  
513 modelling of building energy consumption based on a hybrid nature-inspired optimization algorithm.  
514 *Energy Build.* 196, 83-93. <https://doi.org/10.1016/j.enbuild.2019.05.031>.

515 Adams, S., Nsiah, C., 2019. Reducing carbon dioxide emissions; Does renewable energy matter?. *Sci. Total*  
516 *Environ.* 693, 133288. <https://doi.org/10.1016/j.scitotenv.2019.07.094>.

517 Kahia, M., Jebli, M. B., Belloumi, M., 2019. Analysis of the impact of renewable energy consumption and  
518 economic growth on carbon dioxide emissions in 12 MENA countries. *Clean Technol. Environ. Policy*.  
519 21(4), 871-885. <https://doi.org/10.1007/s10098-019-01676-2>.

520 Akter, M. N., Mahmud, M. A., Oo, A. M., 2017. Comprehensive economic evaluations of a residential building  
521 with solar photovoltaic and battery energy storage systems: An Australian case study. *Energy Build.* 138,  
522 332-346. <https://doi.org/10.1016/j.enbuild.2016.12.065>.

523 Ban, M., Guo, D., Yu, J., Shahidepour, M., 2019. Optimal sizing of PV and battery-based energy storage in  
524 an off-grid nanogrid supplying batteries to a battery swapping station. *J. Mod. Power Syst. Clean Energy*.  
525 7 (2), 309-320. <https://doi.org/10.1007/s40565-018-0428-y>.

- 526 Leonori, S., De Santis, E., Rizzi, A., Mascioli, F. F., 2016, October. Optimization of a micro-  
527 grid energy management system based on a fuzzy logic controller. Paper presented at the 42nd  
528 Annual Conference of the IEEE Industrial Electronics Society, Florence, Italy (pp. 6615-6620).  
529 <https://doi.org/10.1109/IECON.2016.7792930>.
- 530 Arun, S. L., Selvan, M. P., 2017. Intelligent residential energy management system for  
531 dynamic demand response in smart buildings. *IEEE Intell. Syst.* 12 (2), 1329-1340.  
532 <https://doi.org/10.1109/JSYST.2017.2647759>.
- 533 Ock, J., Issa, R. R., Flood, I., 2016, December. Smart building energy management systems (BEMS) simula-  
534 tion conceptual framework. Paper presented at the 2016 Winter Simulation Conference (WSC), Arlington,  
535 Virginia, USA (pp. 3237-3245). <https://doi.org/10.1109/WSC.2016.7822355>.
- 536 Huang, L., Walrand, J., Ramchandran, K., 2012, March. Optimal demand response with en-  
537 ergy storage management. Paper presented at the 2012 IEEE Third International Con-  
538 ference on Smart Grid Communications (SmartGridComm) Tainan, Taiwan (pp. 61-66).  
539 <https://doi.org/10.1109/SmartGridComm.2012.6485960>.
- 540 Olivieri, Z. T., McConky, K., 2020. Optimization of residential battery energy storage system scheduling for  
541 cost and emissions reductions. *Energy Build.* 210, 109787. <https://doi.org/10.1016/j.enbuild.2020.109787>.
- 542 Haidar, N., Attia, M., Senouci, S. M., Aglzim, E. H., Kribeche, A., Asus, Z. B., 2018. New consumer-  
543 dependent energy management system to reduce cost and carbon impact in smart buildings. *Sustain.*  
544 *Cities Soc.* 39, 740-750. <https://doi.org/10.1016/j.scs.2017.11.033>.
- 545 Moradi, H., Abtahi, A., Esfahanian, M., 2016, February. Optimal operation of a multi-source microgrid to  
546 achieve cost and emission targets. Paper presented at the 2016 IEEE Power and Energy Conference at  
547 Illinois (PECI) Urbana, Illinois, USA (pp. 1-6). <https://doi.org/10.1109/PECI.2016.7459258>.
- 548 Mahmud, K., Hossain, M. J., Town, G. E., 2018. Peak-load reduction by coordinated re-  
549 sponse of photovoltaics, battery storage, and electric vehicles. *IEEE Access.* 6, 29353-29365.  
550 <https://doi.org/10.1109/ACCESS.2018.2837144>.
- 551 Gomes, I. S. F., Perez, Y., Suomalainen, E., 2020. Coupling small batteries and PV generation: a review.  
552 *Renew. Sustain. Energy Rev.* 126, 109835. <https://doi.org/10.1016/j.rser.2020.109835>.
- 553 Shukhobodskiy, A. A., Colantuono, G., 2020. RED WoLF: Combining a battery and thermal energy reservoirs  
554 as a hybrid storage system. *Appl. Energy.* 274, 115209. <https://doi.org/10.1016/j.apenergy.2020.115209>.

555 McKenna, R., Fehrenbach, D., Merkel, E., 2019. The role of seasonal thermal energy storage in increasing  
556 renewable heating shares: A techno-economic analysis for a typical residential district. *Energy Build.* 187,  
557 38-49. <https://doi.org/10.1016/j.enbuild.2019.01.044>.

558 Monacchi, A., Egarter, D., Elmenreich, W., D'Alessandro, S., Tonello, A. M., 2014, November. GREEND:  
559 An energy consumption dataset of households in Italy and Austria. Paper presented at the 2014 IEEE  
560 International Conference on Smart Grid Communications (SmartGridComm) Venice, Italy (pp. 511-516).  
561 <https://doi.org/10.1109/SmartGridComm.2014.7007698>.

562 Nature Scientific Data, UK-DALE <https://www.nature.com/articles/sdata20157#Sec10>.

563 NREL, 2020, PVWatt Calculator. <https://pvwatts.nrel.gov/pvwatts.php>.

564 EU Science Hub, 2020, Photovoltaic Geographical Information System. [https://ec.europa.eu/jrc/en/  
565 pvgis](https://ec.europa.eu/jrc/en/pvgis).

566 National Grid ESO, Carbon Intensity API. <https://carbonintensity.org.uk>.

567 RTE, éCO2mix. <https://www.rte-france.com/eco2mix>.

568 Statista, Le prix de l'électricité en Europe [https://fr.statista.com/infographie/11825/comparaison-  
569 cout-electricite-en-europe/](https://fr.statista.com/infographie/11825/comparaison-<br/>569 cout-electricite-en-europe/).

570 Benyus, J. M., 1997. *Biomimicry: Innovation inspired by nature* (pp. 9-10). New York: Morrow.

571 énergie Positive & Réduction carbone, Projet de documents méthode pour la Réglementation en-  
572 vironnementale 2020 (RE2020) [http://www.batiment-energiecarbone.fr/projet-de-documents-  
573 methode-pour-la-reglementation-a126.html](http://www.batiment-energiecarbone.fr/projet-de-documents-<br/>573 methode-pour-la-reglementation-a126.html).