



**HAL**  
open science

## Performance of CVD diamond detectors for single ion beam-tagging applications in hadrontherapy monitoring

Sébastien Curtoni, Marie-Laure Gallin-Martel, Latifa Abbassi, Alexandre Bes, Germain Bosson, Johann Collot, Thierry Crozes, Denis Dauvergne, Wout de Nolf, Pierre Everaere, et al.

### ► To cite this version:

Sébastien Curtoni, Marie-Laure Gallin-Martel, Latifa Abbassi, Alexandre Bes, Germain Bosson, et al.. Performance of CVD diamond detectors for single ion beam-tagging applications in hadrontherapy monitoring. Nuclear Instruments and Methods in Physics Research Section A: Accelerators, Spectrometers, Detectors and Associated Equipment, 2021, 1015, pp.165757. 10.1016/j.nima.2021.165757 . hal-03227464

**HAL Id: hal-03227464**

**<https://hal.science/hal-03227464>**

Submitted on 16 Oct 2023

**HAL** is a multi-disciplinary open access archive for the deposit and dissemination of scientific research documents, whether they are published or not. The documents may come from teaching and research institutions in France or abroad, or from public or private research centers.

L'archive ouverte pluridisciplinaire **HAL**, est destinée au dépôt et à la diffusion de documents scientifiques de niveau recherche, publiés ou non, émanant des établissements d'enseignement et de recherche français ou étrangers, des laboratoires publics ou privés.



Distributed under a Creative Commons Attribution - NonCommercial 4.0 International License

# Performance of CVD diamond detectors for single ion beam-tagging applications in hadrontherapy monitoring

S. Curtioni<sup>a,\*</sup>, M.-L. Gallin-Martel<sup>a</sup>, S. Marcatili<sup>a</sup>, L. Abbassi<sup>b</sup>, A. Bes<sup>a</sup>, G. Bosson<sup>a</sup>, J. Collot<sup>a</sup>, T. Crozes<sup>b</sup>, D. Dauvergne<sup>a</sup>, W. De Nolf<sup>c</sup>, P. Everaere<sup>a</sup>, L. Gallin-Martel<sup>a</sup>, A. Ghimouz<sup>a</sup>, F. Haddad<sup>d,e</sup>, C. Hoarau<sup>a</sup>, J.-Y. Hostachy<sup>a</sup>, C. Koumeir<sup>d,e</sup>, A. Lacoste<sup>a</sup>, V. Métivier<sup>e</sup>, J. Morse<sup>c</sup>, J.-F. Motte<sup>b</sup>, J.-F. Muraz<sup>a</sup>, F. Poirier<sup>d,e</sup>, F. E. Rarbi<sup>a</sup>, O. Rossetto<sup>a</sup>, M. Salomé<sup>c</sup>, N. Servagent<sup>e</sup>, E. Testa<sup>f</sup>, M. Yamouni<sup>a</sup>

<sup>a</sup>*Université Grenoble-Alpes, CNRS, Grenoble INP, LPSC-IN2P3 UMR 5821, 38000 Grenoble, France*

<sup>b</sup>*Université Grenoble-Alpes, CNRS, Institut Néel, NANOFAB UPR2940, 38000 Grenoble, France*

<sup>c</sup>*European Synchrotron Radiation Facility, 38000 Grenoble, France*

<sup>d</sup>*GIP ARRONAX, 44800 Saint Herblain, France*

<sup>e</sup>*Université de Nantes, CNRS, IMT Atlantique, SUBATECH-IN2P3 UMR 6457, 44000 Nantes, France*

<sup>f</sup>*Université de Lyon, CNRS, IP2I-IN2P3 UMR 5822, 69000 Lyon, France*

---

## Abstract

In the context of online ion range verification in particle therapy, the CLaRyS collaboration is developing Prompt-Gamma (PG) detection systems. The originality in the CLaRyS approach is to use a beam-tagging hodoscope in coincidence with the gamma detectors to provide both temporal and spatial information of the incoming ions. The ion range sensitivity of such PG detection systems could be improved by detecting single ions with a 100 ps ( $\sigma$ ) time resolution, through a quality assurance procedure at low beam intensity at the beginning of the treatment session. This work presents

---

\*Corresponding author: [curtoni@cppm.in2p3.fr](mailto:curtoni@cppm.in2p3.fr)

the investigations that led to assessment of the Chemical Vapor Deposition (CVD) diamond detectors performance to fulfil these requirements. A  $^{90}\text{Sr}$  beta source, 68 MeV protons, 95 MeV/u carbon ions and a synchrotron X-ray pulsed beam were used to measure the time resolution, single ion detection efficiency and proton counting capability of various CVD diamond samples. An offline technique, based on double-sided readout with fast current preamplifiers used to improve the signal-to-noise ratio, is also presented. The different tests highlighted Time-Of-Flight resolutions ranging from 13 ps ( $\sigma$ ) to 250 ps ( $\sigma$ ), depending on the diamond crystal quality and the particle type and energy. The single 68 MeV proton detection efficiency of various large area polycrystalline (pCVD) samples was measured to be  $>96\%$  using coincidence measurements with a single-crystal reference detector. Single-crystal CVD (sCVD) diamond proved to be able to count a discrete number of simultaneous protons while it was not achievable with a polycrystalline sample. Considering the results of the present study, two diamond hodoscope demonstrators are under development: one based on sCVD, and one of larger size based on pCVD. They will be used for the purpose of single ion as well as ion bunches detection, either at reduced or clinical beam intensities.

*Keywords:* CVD diamond, hadrontherapy, ion range verification, time resolution, detection efficiency, particle counting, beam monitoring

---

## 1. Introduction

Hadrontherapy is an external radiotherapy modality based on light ion beams [1, 2]. Even though the ballistic properties of ions and the enhanced relative biological effectiveness represent essential advantages of particle ther-

5 apy compared to conventional X-ray radiotherapy, it is still facing limitations  
6 due to ion range uncertainties arising at every stage of the treatment pro-  
7 cedure [3]. They currently lead physicians to set ion range specific safety  
8 margins that limit the dose conformation and prevent them to plan irradiation  
9 fields where organs at risk are located close beyond the targeted volume.

10 In this context, several experimental approaches have been developed to  
11 build an online ion range verification system [4, 5]. Among them, prompt-  
12 gamma-based verification techniques [6] propose to retrieve the actual ion  
13 range from the emission profile of prompt-gamma photons (PG) that are  
14 emitted along the ion path by excited target nuclei or ion fragments right  
15 after inelastic collisions between incoming ions and target nuclei. To get rid  
16 of the inherent and substantial neutron-induced background also produced  
17 during these nuclear interactions, PG detection systems use a Time-Of-Flight  
18 (TOF) based gamma-neutron discrimination. It is generally carried out by  
19 coincidence measurements between the gamma camera trigger and the ion  
20 bunch time of arrival given by the accelerator radio-frequency signal (RF).  
21 Provided the body-camera distance is set to a few tens of centimeters, an  
22 overall TOF resolution of 1 ns ( $\sigma$ ) is sufficient to achieve this purpose.

23 Instead of using the accelerator RF as a START signal, the CLaRyS  
24 collaboration proposes to set up a beam-tagging hodoscope upstream from  
25 the patient at reduced intensity ( $\sim 1$  ion/bunch). It will also provide an  
26 ion transverse position that is useful for PG vertices reconstruction with PG  
27 imaging systems (PGI). The direct detection of incoming ions also makes  
28 the TOF measurement independent of the beam time structure and/or any  
29 potential RF phase shift as has been observed [7]. According to this idea, the

30 collaboration has developed a  $12.8 \times 12.8 \text{ cm}^2$  scintillating-fiber hodoscope.  
31 It has been tested and characterized on proton and carbon ion beams [8] and  
32 the results highlighted a 0.7 ns ( $\sigma$ ) time resolution and a detection efficiency  
33 up to 98%.

34 Considerable improvements can be achieved in the sensitivity of potential  
35 ion range shift determination by improving the TOF resolution down to a few  
36 hundred picoseconds. This holds for PGI and prompt gamma timing (PGT)  
37 [9, 10, 11] and is thoroughly discussed in [12]. Different detector technologies  
38 could enable the development of a beam monitor with a 100 ps ( $\sigma$ ) time  
39 resolution for single ion detection [13, 14, 15]. The collaboration has chosen  
40 to focus on Chemical Vapor Deposition (CVD) diamond technology in order  
41 to develop a beam hodoscope upgrade combining an excellent time resolution  
42 [16],[15] (and references therein) and high radiation hardness guaranteeing  
43 long-term stability in clinical conditions.

44 The current work presents investigations led on diamond detectors, at  
45 first, to evaluate polycrystalline (pCVD) single proton detection efficiency.  
46 Then, experiments were carried out to assess single crystal (sCVD), pCVD  
47 and Diamond On Iridium (DOI) detector ability to perform TOF measure-  
48 ments with a 100 ps resolution, using 68 MeV single protons in ARRONAX  
49 (Saint-Herblain, France), 95 MeV/u carbon ions in GANIL (Caen, France),  
50 short pulses of 8.53 keV X-rays at ESRF (Grenoble, France) and minimum  
51 ionizing particle (MIP) with a  $^{90}\text{Sr}$  laboratory source. Finally, the sCVD and  
52 pCVD diamond detectors single particle counting capabilities have been eval-  
53 uated with the 68 MeV proton beam delivered by the ARRONAX cyclotron  
54 at low intensity (6 pA  $\sim$  1 proton/bunch).

## 55 **2. Material and methods**

### 56 *2.1. Detectors assembly and generic experimental set-up*

57 The detector-grade diamond samples used in the present work are com-  
58 mercially available and produced by Chemical Vapor Deposition (CVD). The  
59 sCVD diamonds were purchased from Element6 [17], pCVD diamonds from  
60 Element6, II-VI [18] and Diamond Delaware Knives (DDK) [19], and DOI  
61 diamonds from Audiatic [20] and Augsburg University. The tested samples  
62 ranged from 300  $\mu\text{m}$  to 500  $\mu\text{m}$  in thickness, and from  $4.5 \times 4.5 \text{ mm}^2$  to 20  
63  $\times 20 \text{ mm}^2$  in area. In particular, large pCVD are foreseen for the assembly  
64 of a large size hodoscope. Diamond samples were assembled as pad detec-  
65 tors as described in [21, 22]. A thin aluminum disk-shaped metallization  
66 was performed either by physical evaporation [23] (50 nm) or by sputtering  
67 (100 nm). The diamonds were sandwiched between two  $50\Omega$ -adapted printed  
68 circuit boards (PCB), allowing bias of both polarities and signal readout con-  
69 nections on both sides.

70 For the different tests presented in this work, diamond detectors were  
71 systematically tested by pair. Figure 1 illustrates the general configuration  
72 used during the tests. Two diamond detectors are exposed to a particle  
73 beam. The detector under test is positioned upstream from a smaller size  
74 reference detector (a sCVD sample, unless stated otherwise). For each beam  
75 test, both detectors were enclosed together in an aluminum shielding box  
76 with front and rear apertures covered with 12  $\mu\text{m}$ -thick aluminized Mylar  
77 films [21, 22]. The output channels of the detectors were coupled to broad-  
78 band amplifiers (CIVIDEC C2-HV [24] or Greenstream DBA III and IV-R)  
79 and analog signals were digitized using fast digitizers (a 500 MHz, 3.2 GS/s

Table 1: Summary of the various diamond samples tested within this work. DE = Single proton detection efficiency, TOF = Time-Of-Flight resolution, C = counting,  $\sigma_t$  = intrinsic time resolution.

Diamond	Provider	Size (mm <sup>3</sup> )	Metallization		Computed capacitance (pF)	Tested with	Involved in measurements:
			Diam. (mm)	Thick. (nm)			
sCVD	E6	4.5 × 4.5 × 0.517	3	50	0.7	X, $\beta$ , p, <sup>12</sup> C	DE, TOF, C
sCVD	E6	4.5 × 4.5 × 0.517	3	50	0.7	$\beta$	TOF
pCVD	E6	10 × 10 × 0.3	7	50 - 100	6.5	X, p, <sup>12</sup> C	DE, TOF
pCVD	E6	20 × 20 × 0.5	16	50	20	<sup>12</sup> C	TOF
pCVD	IL-VI	10 × 10 × 0.5	7	100	3.9	p	DE, TOF
pCVD	DDK	5 × 5 × 0.3	3	100	1.2	p	DE, TOF, C
DOI	Augsburg Univ.	5 × 5 × 0.3	3	50 - 100	1.2	X, p, <sup>12</sup> C	TOF, $\sigma_t$
DOI	Audiatec	5 × 5 × 0.3	3	50	1.2	X	$\sigma_t$

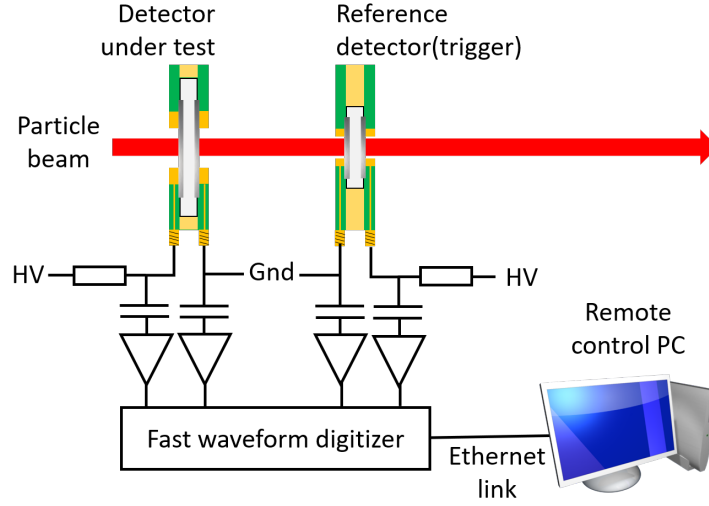

Figure 1: Generic experimental set-up used for detection efficiency, timing and counting measurements presented in this work. Specific dedicated additions in the set-up are presented in the corresponding subsections.

80 WaveCatcher digitizer [25] or a 2 GHz, 20 GS/s LeCroy Digital Storage Os-  
 81 cilloscope (DSO)).

82 *2.2. Side-to-side signals summation*

83 During the interaction of a ionizing particle in a diamond detector, the  
 84 same signal  $S$  (absolute value) is induced on both electrodes by the elec-  
 85 tron/hole pairs drift. In practice, each side is read by a single preamplifier  
 86 generating an output signal of amplitude  $S^{side_i}$  (with  $i=1,2$ ) with a corre-  
 87 sponding noise level  $\sigma_n^{side_i}$  resulting in a signal-to-noise ratio  $S^{side_i}/\sigma_n^{side_i}$ .  
 88 First, we assume that the intrinsic noise generated by the diamond itself is  
 89 negligible at 300 K compared to that induced by the wide-band preamplifier.  
 90 Then, the noise of each preamplifier is assumed to be an independent Gaus-  
 91 sian white noise. Therefore, the resulting noise on the sum-signal  $\sigma_n^{sum}$  can  
 92 be expressed as follows:

$$\sigma_n^{sum} = \sqrt{(\sigma_n^{side_1})^2 + (\sigma_n^{side_2})^2} = \sigma_n^{side_1} \oplus \sigma_n^{side_2}. \quad (1)$$

93 A sum signal  $S^{sum} = S^{side_1} - S^{side_2}$  (the two side signals are of opposite  
 94 polarity) can be derived as well as a sum-signal-to-noise ratio:

$$S/N_{sum} = \frac{S^{side_1} - S^{side_2}}{\sigma_n^{side_1} \oplus \sigma_n^{side_2}}. \quad (2)$$

95 If one supposes now that the two preamplifiers are strictly identical, Equation  
 96 2 becomes:

$$S/N_{sum} = \frac{2S^{side}}{\sqrt{2}\sigma_n} = \frac{2S^{side}}{\sigma_n\sqrt{2}} = \sqrt{2} \cdot S/N_{side}. \quad (3)$$

97 Using the sum signal, the signal-to-noise ratio (SNR) can be increased by a  
 98 factor  $\sqrt{2}$ . By doubling the amplitude of the signal, the slope in the rising  
 99 edge of the sum-signal can become up to twice as much as the one measured



100 on each electrode signal improving the time resolution of the detector con-  
101 sequently. This technique was used for the detection efficiency and timing  
102 measurements presented in Sections 2.3.1 and 2.3.2. Note that this technique  
103 requires identical preamplifiers (same pulse shape), a strict adjustment of the  
104 pulses risetime and a null delay between both side signals.

### 105 *2.3. Experimental tests and data analysis procedures*

#### 106 *2.3.1. Single proton detection efficiency of pCVD detectors*

107 The single proton detection efficiency has been evaluated with 68 MeV  
108 protons during a dedicated experiment at ARRONAX IBA C70 isochronous  
109 cyclotron, Nantes (with a fixed Radio-Frequency of 30.45 MHz) [26, 27]. In  
110 order to restrict the incoming beam to bunches containing at most one single  
111 proton, the beam intensity was lowered down to 50 fA. Three different pCVD  
112 detectors presented in Table 1 and based on samples coming from different  
113 providers were tested one-by-one during the experiment in reproducible con-  
114 ditions. Each pCVD sample was tested in coincidence with the same sCVD  
115 reference detector. The detectors box was set up and aligned between two  
116 2.5 cm-thick aluminum collimators with 5 mm gaps. The upstream one was  
117 used to constrain the proton incidence to the sensitive surface of the smallest  
118 detector. The downstream one reduced the beam halo caused by the scatter-  
119 ing of protons in the PCBs. Behind the second collimator, a PTW T34058  
120 gas ionization chamber (IC) and a 5 mm-thick plastic scintillator coupled to  
121 a photomultiplier tube (PMT) were aligned with the beam. The IC was  
122 coupled to a PTW Unidos electrometer to measure the beam current while  
123 the scintillator was used to get a redundant spectroscopic information of in-  
124 coming ions that was used for the efficiency measurement. The applied bias

125 voltage was +300 V for the Element6 and DDK pCVD detectors, +500V for  
 126 the II-VI pCVD detector and +300 V for the sCVD detector, according to  
 127 the scheme presented in Figure 1. The applied biasing was +400 V for the  
 128 IC and -800 V for the PMT. The two pCVD output channels were coupled  
 129 to Greenstream DBA IV-R preamplifiers [28] while CIVIDEC C2-HV pream-  
 130 plifiers were used for the sCVD sample. Analog signals from the diamond  
 131 detectors and the scintillator were sampled using the WaveCatcher digitizer.

132 To assess the single proton detection efficiency of pCVD samples, mea-  
 133 surements in coincidence with the two reference detectors (the sCVD and  
 134 the scintillator) were used. First, recorded events that corresponded to a  
 135 double coincidence between the two reference detectors were identified using  
 136 a coincidence window of duration  $\delta t = 1.25$  ns, as well as low and high volt-  
 137 age thresholds selecting single proton events. Among the  $N_{double}(\delta t)$  events  
 138 that corresponded to these criteria, triple and random coincidences were  
 139 tested event-by-event on the pCVD samples using two coincidence windows  
 140 and a voltage threshold scanning. The triple coincidence window was the  
 141 same as the one applied on the reference detectors. The random coincidence  
 142 window was delayed by 15 ns, between two consecutive bunches (32.84 ns).  
 143 Using the voltage threshold sweep, a voltage comparison is performed on  
 144 the pCVD signal between the threshold level  $V_{th}$  and the waveform segments  
 145 contained within the coincidence windows. For each  $V_{th}$  value, we counted  
 146  $N_{triple}(V_{th}; \delta t)$  triple coincidences between the pCVD and the two reference  
 147 detectors and  $N_{random}(V_{th}; \delta t)$  random coincidences triggered by noise fluctu-  
 148 ations in the pCVD signals. Thus, we can define a true coincidence detection  
 149 efficiency  $\epsilon(V_{th}; \delta t)$  at a given threshold value  $V_{th}$  ( $\delta t$  is a fixed parameter)

150 as follows:

$$\epsilon(V_{th}; \delta t) = \frac{N_{triple}(V_{th}; \delta t)}{N_{double}(\delta t)} \times \left( 1 - \frac{N_{random}(V_{th}; \delta t)}{N_{double}(\delta t)} \right). \quad (4)$$

151 Equation 4 can be understood as the product of the probability to detect  
152 a true triple coincidence and the probability not to detect a random coin-  
153 cidence. As  $\delta t$  is fixed, the single proton detection efficiency  $\epsilon_{det}$  was here  
154 defined as the maximum of the obtained  $\epsilon(V_{th})$  function.

### 155 2.3.2. Timing resolution with single ions

156 The experimental set-up presented in Figure 1 was used in various beam  
157 test configurations as listed in Section 1 in order to evaluate the TOF reso-  
158 lution achievable between two diamond detectors of various crystalline qual-  
159 ities. Within the scope of this article, the TOF resolution  $\sigma_{TOF}$  of a pair of  
160 independent detectors with respective time resolution  $\sigma_{t_1}$  and  $\sigma_{t_2}$  is defined  
161 as:

$$\sigma_{TOF} = \sqrt{\sigma_{t_1}^2 + \sigma_{t_2}^2}. \quad (5)$$

162 Timing measurements were carried out on the digitized waveforms using  
163 a normalised threshold algorithm, as defined in [29]. Once the amplitude  
164 of a pulse is detected, a constant fraction of this value (between 20% and  
165 50%) is computed. The pulse time stamp is finally obtained by means of  
166 a linear interpolation between waveform samples, thus emulating an ana-  
167 log Constant Fraction Discrimination (CFD). Unless stated otherwise, the  
168 timing resolution is derived from the statistical dispersion measured on the  
169 timing difference between the sum signals of the two detectors involved. Fur-

170 thermore, a pair of diamond detectors composed of a  $5.0 \times 5.0 \times 0.3 \text{ mm}^3$   
171 DOI detector produced at Augsburg University and a  $4.5 \times 4.5 \times 0.517 \text{ mm}^3$   
172 sCVD detector produced by Element6 were tested together in the different  
173 beam tests presented in this work. They were systematically tested to pro-  
174 vide a common reference for comparison purposes and are referred as the  
175 sCVD-DOI reference pair, later on in this article.

176 At ARRONAX, the timing measurements were carried out on the wave-  
177 form datasets we acquired for the single proton detection efficiency assess-  
178 ment. We could therefore measure the TOF resolution for the three pCVD-  
179 sCVD couples, as they are presented in Table 1 and Section 2.3.1. For each  
180  $V_{th}$  value, the events subset which fulfilled the triple coincidence criterion and  
181 did not trigger random coincidences was selected. On this subset, the pulse  
182 discrimination was performed using the normalised threshold algorithm on  
183 the pCVD and sCVD sum signals. The distribution of the timing difference  
184 between the discriminated pCVD and sCVD signals was then stored in a his-  
185 togram. Since some distributions demonstrated non-gaussian tails on each  
186 side, the root mean square (RMS) value of the histogram was chosen as an  
187 estimator of the TOF resolution for all histograms (*i.e.* for each  $V_{th}$  value).

188 The timing measurements at GANIL were carried out with single 95  
189 MeV/u carbon ions and the standard bench presented in Figure 1. Yet,  
190 one noteworthy difference is that only one CIVIDEC C2-HV preamplifier  
191 could be used for each diamond detector during this test, preventing us from  
192 using the signal summation technique introduced in Section 2.2. The wave-  
193 forms were digitized with the 3.2 GS/s WaveCatcher system. Two pairs of  
194 detectors were tested. The first one is the sCVD-DOI reference pair and the

195 second one is composed of two Element6 pCVD detectors,  $20 \times 20 \times 0.5 \text{ mm}^3$   
196 and  $10 \times 10 \times 0.3 \text{ mm}^3$  respectively. They were metallized as pad detectors,  
197 with disk-shaped 50nm-thick Al electrodes and respective diameter of 16 mm  
198 and 7 mm.

### 199 *2.3.3. Timing resolution with a pulsed X-ray beam*

200 At ESRF, the combined use of a X-ray micro-beam and various atten-  
201 uators set up upstream from the detectors enabled us to study the time  
202 response of a pair of diamond detectors as a function of the energy depo-  
203 sition. The test beam took place in ID21 beamline [30] that delivered a  
204 8.53 keV X-ray micro-beam while the ESRF synchrotron was running in 4-  
205 bunch mode. In this configuration, the pulsed beam RF was  $f_{RF} = 1.42 \text{ MHz}$   
206 ( $T_{RF} = 704 \text{ ns}$ ) and the bunch duration was 100 ps. With the maximum elec-  
207 tron beam current (32 mA) circulating in the synchrotron, the primary X-ray  
208 flux was  $\phi_{32mA} = 1.79 \cdot 10^9 \text{ photons/s}$  [31], which corresponds to  $1.26 \cdot 10^3 \text{ pho-}$   
209  $\text{tons/bunch}$ . The absorption length of X-rays with an energy  $E_X = 8.53 \text{ keV}$   
210 in diamond is  $1/\mu_{diam} \sim 790 \text{ }\mu\text{m}$  [32]. As a result, the energy deposition is  
211 almost uniformly distributed over the thickness of the tested samples (300 -  
212 500  $\mu\text{m}$ ) thus mimicking the passage of single charged particles.

213 The two detectors used here were a  $4.5 \times 4.5 \times 0.517 \text{ mm}^3$  Element6 sCVD  
214 detector and a  $5.0 \times 5.0 \times 0.3 \text{ mm}^3$  Audiatec DOI detector. Both were metal-  
215 lized with aluminium disk electrodes of 3 mm diameter. For each attenuator  
216 used (Al and Ti foils with various thicknesses), an acquisition of the signals  
217 coming from the two detectors as well as of the RF signal was performed.  
218 Each side electrode of the Audiatec sensor was coupled to a CIVIDEC C2-HV  
219 preamplifier while only one was used on the sCVD detector. For a given at-

220 tenuous type and thickness, the energy deposits of a X-ray bunch in the DOI  
 221 and sCVD detectors (thereafter noted  $\Delta E_{DOI}$  and  $\Delta E_{sCVD}$ ) are computed  
 222 using Beer-Lambert law as follows :

$$\begin{aligned} \Delta E_{DOI} = E_X \cdot \frac{\phi_{32mA}}{f_{RF}} \cdot \exp(-\mu_{att}x_{att} - \mu_{PET}x_{PET}) \\ \cdot [1 - \exp(-\mu_{diam}d_{DOI})] , \end{aligned} \quad (6)$$

$$\begin{aligned} \Delta E_{sCVD} = E_X \cdot \frac{\phi_{32mA}}{f_{RF}} \\ \cdot \exp(-\mu_{att}x_{att} - \mu_{PET}x_{PET} - \mu_{diam}d_{DOI}) \\ \cdot [1 - \exp(-\mu_{diam}d_{sCVD})] , \end{aligned} \quad (7)$$

223 where  $\mu$  and  $x$  are respectively the attenuation coefficient at 8.53 keV and  
 224 the thickness of the considered material (att = attenuator, PET = Mylar,  
 225 diam = diamond) while  $d$  is the thickness of the detector. In this set-up, the  
 226 attenuation ( $< 0.7\%$ ) of the beam in the air path between the detectors was  
 227 neglected. For each acquisition, the signals have been processed using the  
 228 normalised threshold algorithm at 50%, as defined in Section 2.3.2.

229 A previous experiment with the DOI detector from Augsburg University  
 230 had been carried out with only a few number of attenuators. During this  
 231 test, the Augsburg DOI sample was coupled to two preamplifiers while the  
 232 sCVD detector was equipped to only one preamplifier. In this case, we had  
 233 measured the side-to-side time difference between pulses generated on the  
 234 two electrodes of the DOI detector. We performed the same measurement  
 235 with the Audiatec sample and compared the timing performance obtained in  
 236 both cases.

237 *2.3.4. Timing resolution with MIP electrons*

238 Using MIP-like electrons allowed us to determine a lower bound of the  
239 timing resolution that could be obtained for the detection of single particles.  
240 In this case, two Element6 sCVD diamond detectors ( $4.5 \times 4.5 \times 0.51 \text{ mm}^3$   
241 each) were used. They were exposed to a collimated beam of electrons from a  
242  $^{90}\text{Sr}$  source, with an energy up to 2.28 MeV. The source, the collimators and  
243 the detectors were all enclosed in a U-shaped rail ensuring the mechanical  
244 alignment of the set-up. An assembly of four scintillating fibres coupled to a  
245 common PMT was added downstream from the diamond detectors. It was  
246 used as an external trigger to detect electrons in the higher energy part of  
247 the  $\beta$  spectrum. Both electrodes of the two diamond detectors were coupled  
248 to CIVIDEC C2-HV preamplifiers via 10 cm coaxial cables. The signals  
249 produced by the four preamplifiers were digitized using a LeCroy HDO9404  
250 DSO (4 GHz, 20 GS/s, 10 bits). The applied bias voltage was -500 V on the  
251 two diamond detectors.

252 *2.3.5. Proton counting*

253 The counting and monitoring capabilities of the diamond samples were  
254 also tested at ARRONAX. The DDK pCVD detector and the Element6  
255 sCVD detector presented in Table 1 were selected for this test. Only one  
256 output channel per detector was used here and the biased electrodes of the  
257 pCVD and the sCVD detectors were coupled to one preamplifier. In order to  
258 acquire 2  $\mu\text{s}$ -long waveforms (corresponding to 60 RF periods at 30.45 MHz),  
259 the sampling rate was lowered down to 2.5 GS/s. A 2.5 cm-thick aluminum  
260 collimator with a 1 mm gap was set up in front of the detectors to constrain  
261 the beam to a section smaller than the sensitive diameter of the detectors.

262 Typical signal waveforms acquired simultaneously on the two detectors are  
263 shown in Figure 2.

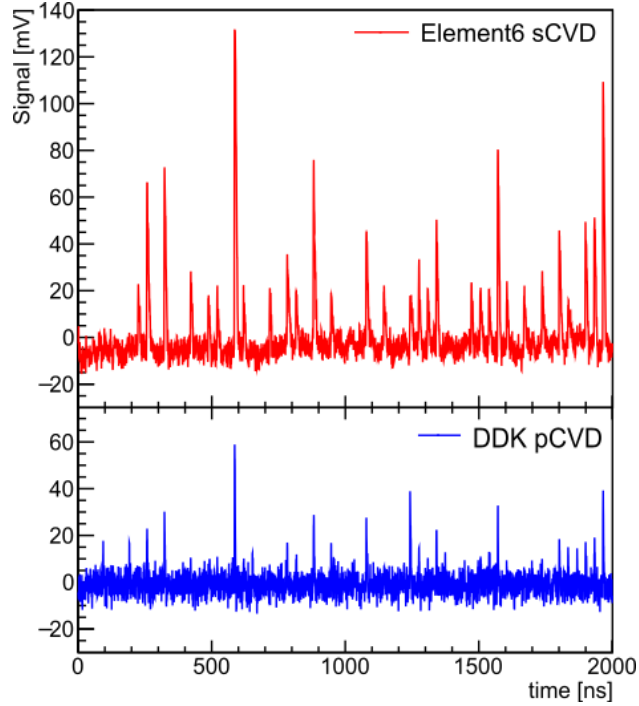

Figure 2: Compared waveforms acquired simultaneously on the Element6 sCVD detector (top, red) and the DDK pCVD detector (bottom, blue) using a 2.5 GS/s sampling rate.

264 In order to count the number of protons contained in the bunches, charge  
265 measurement was performed by numerical integration of the waveforms on  
266 both detectors. First, a baseline correction was achieved by projecting all  
267 the waveform samples voltage values in an histogram. Considering that some  
268 RF periods do not contain protons at this beam current level ( $\sim 5$  pA) and  
269 that the signal duration is short compared to the RF period, the histogram  
270 exhibits a dominant Gaussian noise peak that can be fitted to derive its mean



271 and standard deviation parameters. They are then defined as estimators of  
 272 the baseline offset value and the noise level  $\sigma$  of the considered waveform,  
 273 respectively. After subtraction of the obtained offset, each waveform is sub-  
 274 divided in 60 33ns-long segments (corresponding to the 60 RF periods). For  
 275 each RF period, the numerical integration is done by summing up the sam-  
 276 ples contained in the corresponding segment. The charge response of both  
 277 detectors can thus be compared on a bunch-by-bunch basis, as presented in  
 278 Section 3.3.

279 From the counting statistics, it is possible to derive a mean beam current  
 280 value. Later on in this paper, we will consider that at a given beam current  
 281  $I_{beam}$ , the number of protons contained in a bunch is a discrete random  
 282 variable  $X$  according to Poisson law, with a  $\lambda$  parameter such as  $\lambda \propto I_{beam}$ .  
 283 The probability  $P(X = k)$  of having  $k$  protons in a bunch is therefore:

$$P(X = k) = \frac{\lambda^k}{k!} e^{-\lambda}. \quad (8)$$

284 In the case of an ideal beam delivering exactly one proton per bunch ( $Q_{bunch} =$   
 285  $e$ ) with a period  $T_{beam} = 32.84$  ns (corresponding to the period of the AR-  
 286 RONAX cyclotron RF signal), the average beam current  $I_{ref}$  is given by:

$$I_{ref} = \frac{Q_{bunch}}{T_{beam}} = \frac{1.602 \cdot 10^{-19}}{32.84 \cdot 10^{-9}} = 4.872 \cdot 10^{-12} \text{ A s/s}. \quad (9)$$

287 Then the average beam current  $I_{beam}$  can be derived as follows:

$$I_{beam} = \lambda I_{ref}. \quad (10)$$

288 This expression will be used later on in this work to estimate the average  
 289 beam current during the counting experiment. Since  $\lambda$  is the parameter of

290 the Poisson law describing a bunch's proton multiplicity, this analysis carried  
291 out on time windows corresponding to 60 consecutive bunches results in a  
292 standard deviation  $\sigma_\lambda = \sqrt{\lambda/60}$ .

### 293 **3. Results**

#### 294 *3.1. Single proton detection efficiency*

295 The results of the analysis presented in Section 2.3.1 and carried out on  
296 the sum signals of the three pCVD samples presented on Table 1 are com-  
297 bined in Figure 3 (dashed lines). The three pCVD detectors highlight the  
298 same behaviour according to the  $V_{th}$  value. If  $V_{th}$  is close to zero, the proba-  
299 bility of a random coincidence triggered by noise fluctuations is comparable  
300 to the probability to trigger on the true event pulse. As a consequence,  $\epsilon$   
301 remains low. If  $V_{th}$  increases, the noise-triggered random coincidence prob-  
302 ability decreases and  $\epsilon$  increases. Beyond an optimal  $V_{th}$  value for which  
303  $\epsilon$  is maximized, the threshold starts rejecting true events resulting in the  
304 degradation of the detection efficiency.

305 Following Section 2.3.1, the single 68 MeV proton detection efficiency  $\epsilon_{det}$  is  
306 here defined as  $\epsilon_{det} = \max(\epsilon(V_{th}))$ . For the three pCVD detectors,  $\epsilon_{det}$  is  
307 obtained at  $V_{th} \sim 13$  mV and reaches 98% for the Element6 sample, while  
308 97% is obtained in the case of the II-VI and DDK samples. These results are  
309 in good agreement with measurements carried out in similar conditions in a  
310 previous study [33] and bring an additional information on random triggering  
311 probability. As these results depend on the  $\delta t$  parameter, one should note  
312 that they could be improved by reducing the coincidence window, which is  
313 in principle possible due to the shortness of the analog pulses. In our case,

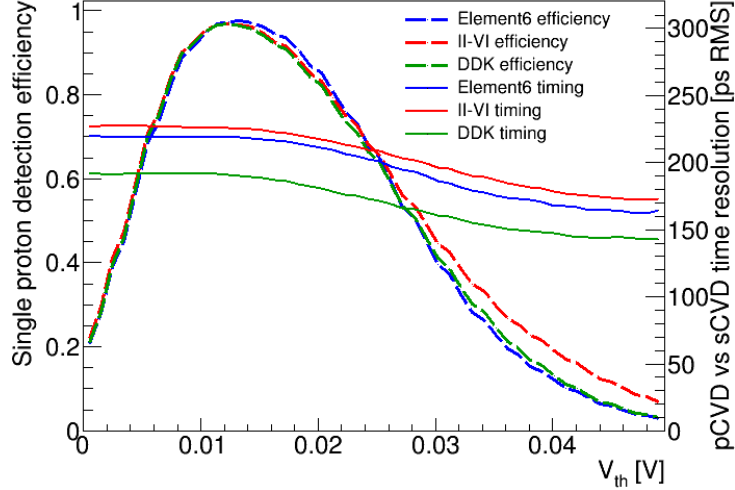

Figure 3: Single 68 MeV proton detection efficiency (dashed lines) and TOF resolution (solid lines) of three pCVD detectors as a function of the threshold value  $V_{th}$  used for the pCVD sum signal discrimination. The coincidence window duration is  $\delta t = 1.25$  ns.

314 the 3.2 GS/s sampling rate was the limiting factor since  $\delta t = 1.25$  ns only  
 315 corresponds to four consecutive waveform samples. Besides, we verified that  
 316 reducing  $\delta t$  induced an increase of the true coincidence detection efficiency,  
 317 particularly for low  $V_{th}$  values. An additional event selection criterion based  
 318 on time-over-threshold (TOT) could be used to reject high frequency noise-  
 319 generated triggers.

### 320 3.2. Timing performance

#### 321 3.2.1. 68 MeV protons

322 Figure 3 also shows the results of the timing measurements that were  
 323 carried out on the same acquired datasets. On Figure 3, the measured TOF  
 324 resolution is plotted as a function of  $V_{th}$  for the three pCVD detectors (solid

325 lines). A similar evolution of the TOF resolution can be observed with the  
326 three pCVD samples. It can be noticed that as long as the threshold level  
327 remains below the value maximizing the detection efficiency, the measured  
328 TOF resolution is rather constant. For higher values, as the threshold rejects  
329 low amplitude signals, the SNR of the selected events increases. Since the  
330 time resolution of diamond detectors is directly related to the SNR [15, 34],  
331 the TOF resolution improves as well. In the case of the Element6 detector,  
332 the TOF resolution ranges from 220 ps (RMS) to 162 ps (RMS) and 218 ps  
333 (RMS) is obtained at best efficiency. The TOF resolution measured with  
334 the II-VI samples ranges from 227 ps (RMS) to 172 ps (RMS) (225 ps at best  
335 efficiency). The DDK provides the best results with a TOF resolution ranging  
336 from 192 ps (RMS) to 139 ps (RMS) (191 ps at best efficiency).

337 The overall better performance obtained with the DDK detector is re-  
338 lated to the capacitance of the devices. That plays a crucial role in timing  
339 measurements [15, 34]. Using the geometries defined in Table 1 and the  
340 relative permittivity of diamond ( $\epsilon_r = 5.7$ ), the DDK detector's computed  
341 capacitance is 1.2 pF compared to 6.5 and 3.9 pF for the Element6 and II-VI  
342 detectors respectively. Despite that, the Element6 sample's timing response  
343 appears to be slightly better than that of the II-VI sample. It therefore tends  
344 to show the superior performance of the Element6 pCVD detector compared  
345 to the II-VI one. As a comparison, in a previous beam test, the sCVD-DOI  
346 reference pair of diamond detectors had been tested in similar conditions and  
347 reached a 94 ps ( $\sigma$ ) TOF resolution [11].

348 3.2.2. 95 MeV/u carbon ions

349 The results of the timing measurements carried out at GANIL are pre-  
 350 sented in Figure 4. Due to the large energy deposition in the detectors (25  
 351 MeV in DOI and 44 MeV in sCVD according to SRIM simulations [35]),  
 352 the high SNR enabled us to lower the discrimination fraction down to 20%.  
 353 Thus, the two detector pairs highlighted excellent results. In each case, the  
 354 distribution could be fitted to derive the  $\sigma_{TOF}$  value. The measured TOF  
 355 resolution of the sCVD-DOI pair is  $\sigma_{TOF} = 13$  ps. In the case of the pCVD  
 356 pair, the obtained TOF resolution was 66 ps ( $\sigma$ ). The difference between the  
 357 results obtained with the two pairs can be explained by the quality of the

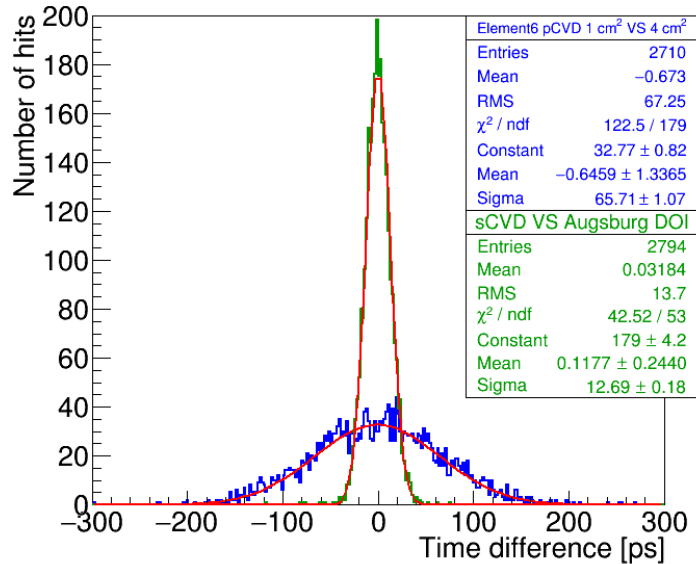

Figure 4: Time difference distributions obtained with two pairs of diamond detectors and single 95 MeV/u carbon ions at GANIL. The two pairs were the sCVD-DOI reference pair (green) and two large area pCVD detectors (blue).

358 involved samples and the large size of the pCVD detectors (with computed  
359 capacitances of 20 pF and 6.5 pF). In any case, the two pairs demonstrated  
360 excellent results nicely fitting with the objectives of the hodoscope.

### 361 3.2.3. *Bunches of 8.53 keV synchrotron radiation X-rays*

362 Figure 5-(Top) represents, for each energy deposition (each attenuator),  
363 the TOF resolution measured between the two detectors (red) and between  
364 each detector and the beam RF (DOI = blue and sCVD = green) as a function  
365 of the deposited energy. The results are fitted with a function  $\sigma_{TOF} = C/\Delta E$   
366 with  $C$  a parameter to highlight the correlation between the TOF resolution  
367 and the deposited energy. Due to the low jitter in the beamline RF signal,  
368 the TOF measurements using the RF signal and a single diamond detec-  
369 tor give better results than TOF measurements made between two diamond  
370 detectors. It also provides a common reference allowing us to deduce that  
371 the sCVD detector gives a better result than the Audiatic one. The re-  
372 sults obtained with these two DOI detectors (Audiatic and Augsburg) are  
373 compared in Figure 5 (Bottom). As the electronic channels used in both  
374 cases were identical (1 CIVIDEC C2-HV per channel), the contribution of  
375 the electronic jitter is the same for the two detectors. The better timing  
376 response of the Augsburg DOI can therefore be related to the intrinsic better  
377 performance of the detector, in comparison with the Audiatic one. While  
378 the side-to-side jitter evolution measured on the Audiatic detector fits pretty  
379 well with an inverse function, it is not the case of the Augsburg DOI sample.  
380 The dashed line fit is drawn to show which correlation would be expected  
381 with these measurements but they seem to be less sensitive to the energy de-  
382 position. A possible explanation may rely on the surface heterogeneity of the

383 Augsburg DOI sample, already highlighted in [31], that could explain that  
 384 the signal shape will depend on the hit position on the detector. Therefore,  
 385 the jitter of the Augsburg sample could be dominated by other factors than  
 386 the energy deposition.

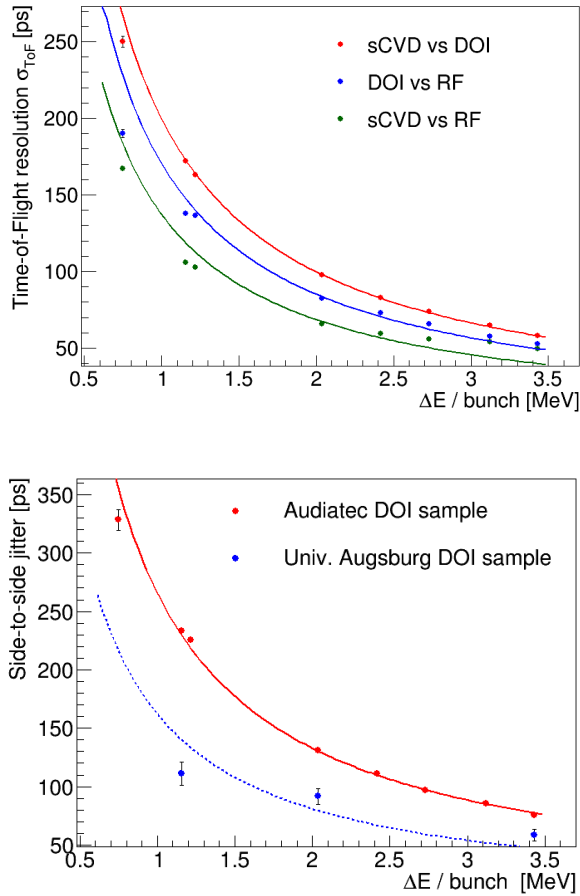

Figure 5: (Top) TOF resolution as a function of the energy deposited by a bunch of 8.53 keV X-rays in a pair of diamond detectors composed of a Element6 sCVD and a Audiatic DOI. (Bottom) Standard deviation of the side-to-side pulses time difference measured on the Audiatic DOI detector (red) and the Augsburg University DOI detector (blue) as a function of the energy deposition in the detectors.

387 *3.2.4. Minimum Ionizing Particles ( $\beta$  source)*

388 Prior to the timing measurement itself, a preliminary analysis was per-  
389 formed at LPSC. As the acquisition was triggered by the downstream scin-  
390 tillator, it is shown in Figure 6 that one can assess the existing correlation  
391 between the responses of the two diamond detectors. Each detector response  
392 corresponds to the integral of the sum signals. The result mainly exhibits two

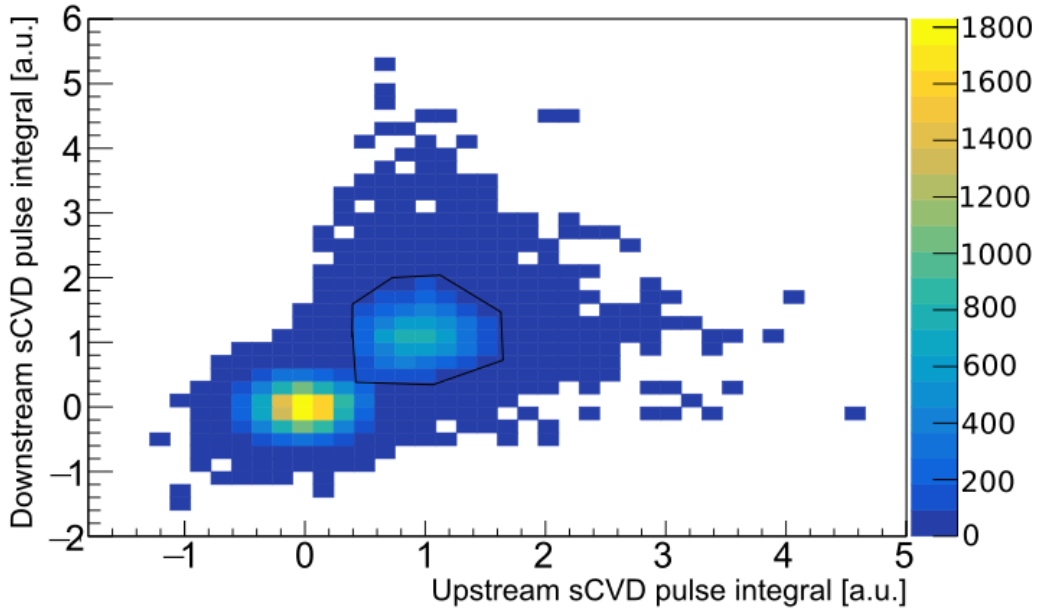

Figure 6: Correlation between the charge response of the two sCVD detectors used for the MIP timing measurement (the acquisition is triggered by the external downstream scintillator). The first peak centered on (0;0) is the noise peak. The second peak is due to single high energy electrons depositing the same amount of energy in the two detectors. The contour drawn on the distribution is the graphical cut applied on the data to measure the time resolution.



393 distributions. The first one is centered on zero and the second corresponds  
 394 to a signal measured simultaneously on both detectors. The statistical pre-  
 395 dominance of the distribution centered on zero is due to the trigger on the  
 396 external scintillator which has i) a larger area than diamonds, and may then  
 397 detect electrons outside the diamond active areas, and ii) a low detection  
 398 threshold, enabling triggering on background.

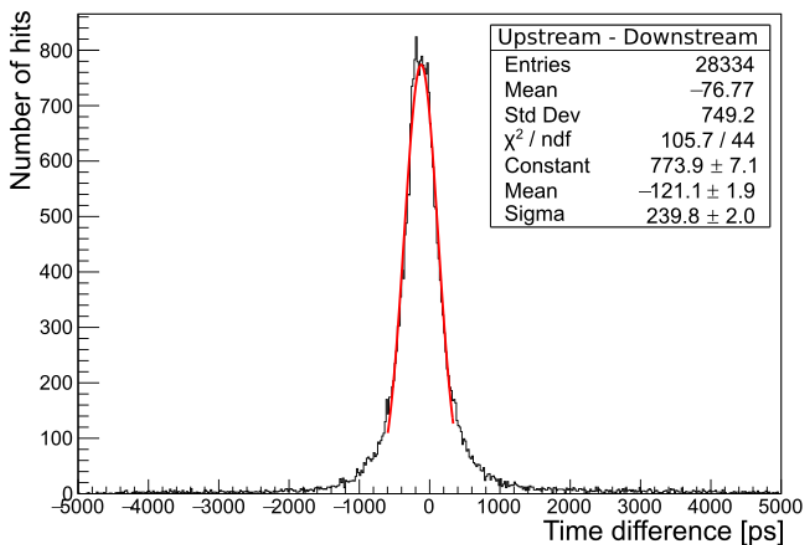

Figure 7: Distribution of the time difference between the sum signals of the two Element6 sCVD detectors detecting the same high energy  $\beta$  electrons.

399 In order to measure the time resolution of the detectors, a graphical selec-  
 400 tion was performed on the data as illustrated by the black contour drawn in  
 401 Figure 6. Since the electrons of highest energy are close to MIP, their energy  
 402 deposition in the two detectors is expected to be almost constant. By se-  
 403 lecting the events which exhibit the same charge response in both detectors,  
 404 we can thus select electrons in the higher energy part of the beta spectrum.

405 The time difference measured on the sum signals of the selected events is  
406 presented in Figure 7. Different estimators can then be used to derive the  
407 TOF resolution in this case. An optimistic estimation would consist in using  
408 the standard deviation given by a Gaussian fit. Choosing such a parameter  
409 neglects the tails present on both sides of the distribution. Under these con-  
410 ditions,  $\sigma_{TOF} = 240$  ps is obtained, which corresponds to a timing resolution  
411 of 170 ps for a single detector. A more objective estimator is the RMS of the  
412 distribution. This one takes into account its tails that strongly degrade the  
413 TOF resolution. Using this estimator, the TOF resolution is 749 ps (RMS),  
414 *i.e.* a timing resolution of 530 ps (RMS) for one detector. However, these  
415 values were obtained using a 10 ns coincidence window, which is of the same  
416 order of the signal duration, and may contain random coincidences.

### 417 3.2.5. Summary of Time-Of-Flight measurements

418 The TOF resolution we measured at laboratory, at ARRONAX and  
419 GANIL are summarized in Table 2 where D1 is the upstream detector and  
420 D2 is the downstream one.

421 The correlation between time resolution and energy deposition (and there-  
422 fore SNR) can be clearly observed. The measurements are better with the  
423 sCVD-DOI reference pair. Using carbon ions at GANIL, the performance  
424 of the pCVD pair is excellent. Considering the large energy deposition of  
425 carbon ions with energies in the hadrontherapy range, developing a pCVD  
426 hodoscope reaching a time resolution  $\leq 100$  ps ( $\sigma$ ) is achievable in carbon ion  
427 therapy. Finally, the measurement with beta electrons allowed us to define  
428 a lower limit to these TOF resolutions.

Table 2: Summary of the different timing measurements presented. The energy deposition of single ions has been estimated with SRIM simulations. \*Result from a previous study [11], given here for completeness purpose.

Diamond	Manuf.	Size (mm <sup>3</sup> )	Computed capacitance (pF)	Particle type	Particle energy (MeV)	Energy deposition per particle/pulse (MeV)	Sum signals used ?	Measured TOF resolution (ps $\sigma$ )
sCVD sCVD	E6	4.5 × 4.5 × 0.517	0.7	<sup>90</sup> Sr decay electron	~ MIP	~ 0.3	✓	240 ± 2
DOI sCVD	Augsburg	5 × 5 × 0.3	1.2	proton	68*	1.0 1.6	✓	94.1 ± 0.4*
	E6	4.5 × 4.5 × 0.517	0.7	carbon ion	1140	25 44	✗	12.7 ± 0.2
	Audiatec E6	5 × 5 × 0.3 4.5 × 4.5 × 0.517	1.2 0.7	X-ray pulse (no attenuator)	8.53 · 10 <sup>-3</sup>	3.4 3.3	DOI only	58.3 ± 0.5
pCVD sCVD	E6	10 × 10 × 0.3	6.5	proton	68	1.0	✓	218 ± 1
	E6	4.5 × 4.5 × 0.517	0.7			1.6	✓	225 ± 1
	II-VI	10 × 10 × 0.5	3.9			1.6	✓	225 ± 1
	E6	4.5 × 4.5 × 0.517	0.7			1.0	✓	191 ± 1
	DDK E6	5 × 5 × 0.3 4.5 × 4.5 × 0.517	1.2 0.7			1.6	✓	191 ± 1
pCVD pCVD	E6 E6	20 × 20 × 0.5 10 × 10 × 0.3	20 6.5	carbon ion	1140	44 25	✗	65.7 ± 1.1

### 429 3.3. Proton counting

430 The monitoring and counting capabilities of sCVD and pCVD detectors  
431 were evaluated at ARRONAX at a beam intensity around 1 proton/bunch.  
432 The results of the bunch-generated ionisation charge  $Q_{bunch}$  as measured  
433 simultaneously on the sCVD and pCVD detectors are presented in Figure 8  
434 (Top). On the one hand, it can be clearly observed that the sCVD detector  
435 has an energy resolution which is sufficient to distinguish a discrete number  
436 of protons contained in each bunch. The 2D distribution therefore exhibits 6  
437 peaks corresponding to bunches whose content ranges from 0 to 5 protons. On  
438 the other hand, the pCVD detector's energy resolution is not good enough to

439 count the number of protons in the bunch, leading to an overlap of the charge  
440 distributions corresponding to different numbers of protons. The different  
441 charge distributions could be separated in this case thanks to the correlation  
442 with the sCVD detector.

443 The sCVD  $Q_{bunch}$  distribution which corresponds to the X-projection of  
444 the 2D histogram in Figure 8-Top is the convolution of a Poisson distribution  
445 of parameter  $\lambda$  with the Gaussian response function of the detector. One  
446 can fit the whole distribution with the sum of 6 Gauss functions. From the  
447 obtained fit parameters and using the fact that  $\lambda = (k + 1) \cdot P(k + 1)/P(k)$ ,  
448 one can derive the actual  $\lambda$  value. From this analysis, an experimental value  
449 of  $\lambda = 1.26 \pm 0.02$  is obtained, thus resulting in a mean beam current  $I_{beam} =$   
450  $6.16 \pm 0.10$  pA (using Equations 9 and 10). The error corresponds to the  
451 RMS of the  $\lambda$  values obtained using the different  $k$  values. Moreover, the  
452  $I_{beam}$  uncertainty could be easily reduced by increasing the integration time.  
453 Note that the method is only valid if the beam current is constant during  
454 the acquisition.

455 Nevertheless, the bunch content separation provided by the sCVD detec-  
456 tor can be used to assess the linearity of the pCVD detector's mean charge  
457 response. Fixed thresholds can be set on the sCVD  $Q_{bunch}$  distribution so  
458 that the response of the pCVD detector can be conditioned by the response of  
459 the sCVD detector. For each peak in the sCVD  $Q_{bunch}$  distribution (ranging  
460 from 0 to 4 protons), the histogram of the corresponding charge measured  
461 on the pCVD is drawn and the obtained mean and RMS values are stored.  
462 The correlation between the mean responses of the two detectors for each  
463 number of protons can thus be plotted (Figure 8 Bottom). In spite of the

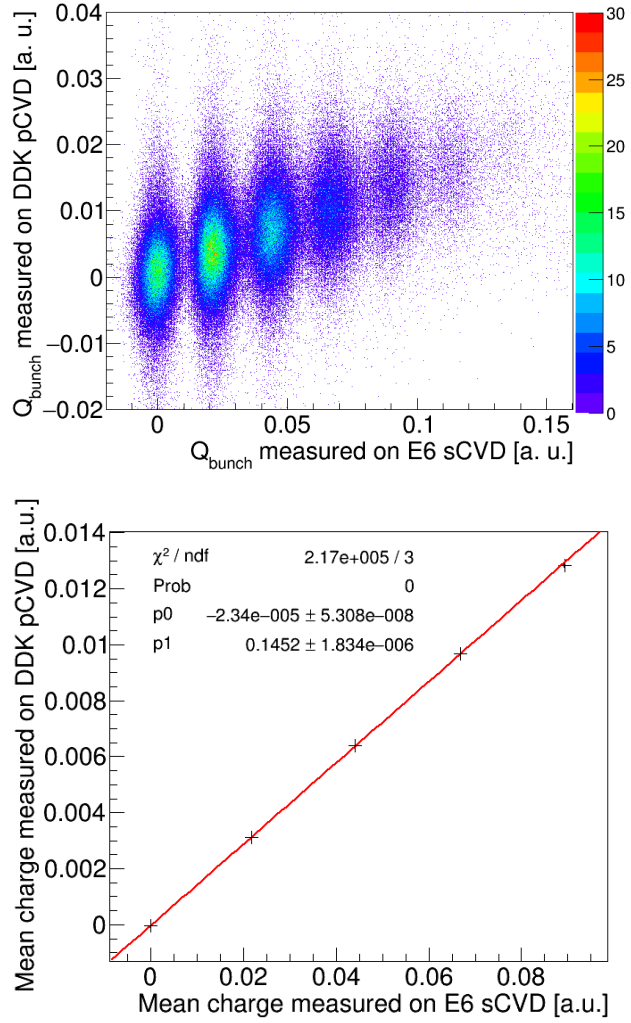

Figure 8: (Top) Bunch-generated ionisation charge measured on the Element6 sCVD detector as a function of the charge generated in the DDK detector. (Bottom) Mean charge generated in the sCVD detector as a function of the mean charge generated in the DDK detector, for a discrete number of protons in the bunch. Error bars are given in the figure but are hidden by the marker size. They correspond to the statistical error obtained for each number of protons.

464 poor pCVD energy resolution, one can note that its mean charge response  
465 remains linear with the number of protons contained in the bunch. There  
466 is no evidence of charge-saturation, and this suggests that pCVD detectors  
467 could be used at higher beam currents (typically clinical beam currents) to  
468 provide an efficient beam monitoring, where the proton bunch multiplicity  
469 prevents from counting the protons individually.

#### 470 **4. Discussion**

471 At first, measurements were carried out to evaluate diamond single proton  
472 true coincidence detection efficiency, *i.e.* the probability to detect a proton in  
473 a time coincidence window as short as possible (1.25 ns), without triggering  
474 on the noise, in order to perform efficient TOF measurements on any incident  
475 proton. They were done using 68 MeV protons in a single incident particle  
476 mode (50 fA). In this way, we could make measurements independent from  
477 the beam time structure. Three pCVD diamond sensors were tested. A pro-  
478 ton coincidence detection efficiency  $> 96\%$  is reached on the three diamond  
479 samples. To perform such a measurement, diamond detectors were read out  
480 on both sides which, in the case of an off-line data analysis, makes it possible  
481 to increase the SNR by a factor  $\sqrt{2}$  when using identical read-out channels.  
482 If one is using this method online, particular care should be paid onto the  
483 exact synchronization and identical pulse shapes on the two readout chan-  
484 nels. Indeed, we could observe that if a slight delay between the two signals  
485 is not corrected, the time resolution is degraded. Also, if the noise levels  
486 are different on the two signals, the noise level of the sum signal is domi-  
487 nated by the worse level as expected from Equation 1, which degrades the

488 performance obtained with the best readout channel. This has an effect on  
489 both efficiency and timing resolution. In the case of a single channel reading,  
490 data analysis has shown that the signal to noise ratio is less favorable. It is  
491 obvious that in terms of efficiency, sCVD diamonds surpass the performance  
492 of pCVD but the commercially available surfaces remain small, which would  
493 imply combining several diamonds in the form of a mosaic to make a larger  
494 detector.

495 The purpose of the hodoscope is to detect each incident ion while ensuring  
496 intrinsic time resolution  $\leq 100$  ps. The best results were obtained with the  
497 sCVD-DOI reference pair. The TOF resolutions obtained with this pair of  
498 detectors are matching the objectives of the project, both with single protons  
499 of 68 MeV and with carbon ions of 95 MeV/u. Indeed, the proton & PG  
500 TOF resolution obtained during a past ARRONAX experiment [11] showed  
501 the capability of our detectors to discriminate PGs with a TOF resolution of  
502 101 ps ( $\sigma$ ), making techniques such as ultra-fast PGT very promising. Such  
503 results could not be obtained with pCVD detectors which exhibit a too low  
504 SNR to be able to measure an equivalent timing resolution with 68 MeV pro-  
505 tons. Moreover, the threshold-based study of their detection efficiency and  
506 time resolution demonstrated that combining a detection efficiency  $> 90\%$   
507 and a time resolution at the 100 ps level was not achievable. A noteworthy  
508 improvement of their time resolution could only be obtained for threshold  
509 values that rejected most of the single-proton signals, thus dramatically de-  
510 teriorating their detection efficiency.

511 It should be also considered that the energy deposition of a 68 MeV proton  
512 is the highest we can get with a single proton in particle therapy. Indeed, the

513 protons energy range varies from 70 MeV to 250 MeV. The deposited energy,  
514 and therefore the generated signal, is inversely proportional to the proton's  
515 initial energy. The combination of these considerations makes difficult the  
516 use of pCVD detectors for time tagging of single protons in the energy range  
517 of proton therapy. We will therefore use sCVD detectors, with the limitation  
518 on the commercially available area for this application.

519 However, the results obtained with carbon ions at GANIL are promising.  
520 The 13 ps ( $\sigma$ ) TOF resolution obtained between the sCVD Element6 detector  
521 and the Augsburg DOI one is the best time performance we measured, in  
522 all our experiments. This result is mainly explained by the large energy  
523 deposition generated by each ion in the diamond and by the quality of the  
524 two diamond samples. This energy deposit is so that a 66 ps ( $\sigma$ ) resolution  
525 between two pCVD detectors was obtained whereas they were metallized  
526 with electrodes of 7 and 16 mm in diameter, respectively. Assuming that  
527 this value is the quadratic sum of their respective timing resolutions, we can  
528 estimate that their individual timing resolution is equivalent to or better  
529 than 66 ps. Besides, in the case of carbon ion therapy, the energy of the  
530 ions ranges from 95 MeV/u to 400 MeV/u. SRIM simulations show that in a  
531 500  $\mu\text{m}$  pCVD diamond with a charge collection efficiency of 30% (measured  
532 on an alpha test bench at laboratory) generates a collected charge ranging  
533 from 156 fC to 61 fC, respectively (see [36]). As a comparison, a 5.49 MeV  
534  $\alpha$  particle (equivalent to 67 fC) generates a sufficient signal to measure an  
535 intrinsic resolution of less than 100 ps [21, 22]. We can thus reasonably  
536 assume that to obtain an intrinsic temporal resolution of 100 ps ( $\sigma$ ) with a  
537 large size (pCVD) detector remains a realistic goal for carbon ion therapy.



538 It should also be noted that in the configuration of our tests, pCVD sen-  
539 sors were not optimized for timing measurements. An improvement of their  
540 timing performance could be obtained by combining different approaches.  
541 First, their thickness could be reduced down to their charge collection dis-  
542 tance so that the applied electric field can be higher. By doing so, a seg-  
543 mentation of the active surface would be necessary to over-compensate the  
544 increase of the capacitance. Using two layers of thin pCVD sensors would  
545 allow to improve the timing performance of the device by a factor  $\sqrt{2}$  and  
546 they could be inclined with respect to the beam axis to increase their effective  
547 thickness.

548 Finally, concerning the particle counting performance, the measurements  
549 carried out with 68 MeV protons at a beam intensity of  $\sim 6$  pA can allow  
550 us to conclude that a beam monitor equipped with sCVD diamond sensors  
551 makes it possible to provide both fast timing and counting of protons inside  
552 a bunch. In terms of hadontherapy beam monitoring, this makes it pos-  
553 sible to count at the start of treatment at reduced beam intensity and, if  
554 necessary, identify bunches where the proton multiplicity is greater than 1.  
555 On the contrary, pCVD detectors are not able to achieve particle counting  
556 at low proton rate. This result on the comparative performance of sCVD  
557 and pCVD diamonds should however be qualified. Indeed, for higher beam  
558 intensity, sCVD diamond sensor thickness is certainly to be optimized to  
559 prevent long time drift which may result in a pile-up phenomenon at highest  
560 RF frequencies (up to 106 MHz). pCVD may present an advantage relative  
561 to sCVD. Since charge trapping occurs while charge carriers are drifting to  
562 the electrodes, it results in a shorter signal as observed in Figure 9 at  $\sim 2$  nA

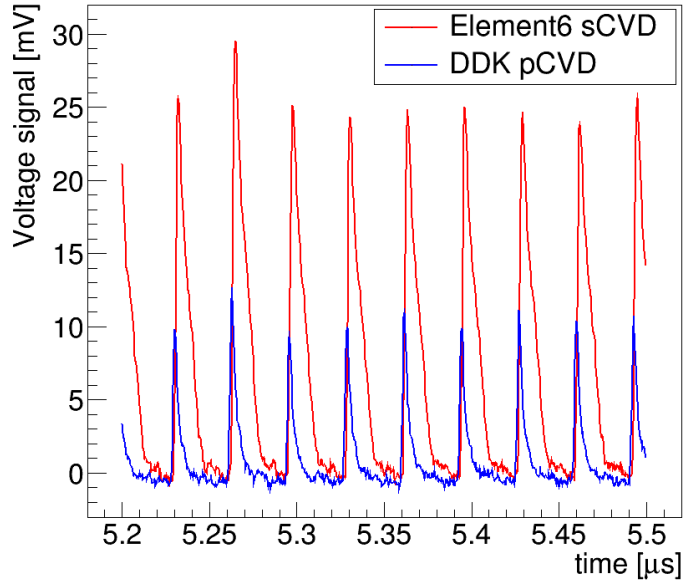

Figure 9: Compared time-domain responses of the Element6 sCVD and the DDK pCVD detectors, irradiated with the ARRONAX proton beam at  $I_{beam} \sim 2$  nA (with an accelerator radio-frequency of 30.45 MHz). The induced currents produced by the detectors are converted into voltage signals through a  $50 \Omega$  resistor.

563 ( $\sim 400$  protons/bunch at 30.45 MHz). Such a beam current is close to clinical  
 564 conditions. Therefore, the two types of diamond could be used depending on  
 565 the targeted intensity range.

## 566 5. Conclusions

567 The present results are encouraging the development of a beam-tagging  
 568 hodoscope with TOF capabilities. For all the tests presented in this work,  
 569 sCVD diamond detectors demonstrated characteristics that are in good agree-  
 570 ment with the requirements of the hodoscope project. The detection effi-

571 ciency measurements highlighted that pCVD detectors can detect single ions  
572 with a good efficiency but can not reach a timing resolution at the order of  
573 100 ps ( $\sigma$ ) when detecting single protons. At low intensity, their poor energy  
574 resolution prevent them from counting the number of protons contained in  
575 a bunch but their mean charge response remains linear with the deposited  
576 energy. At higher intensity, the shorter pulses generated by pCVD detectors  
577 can represent an advantage over sCVD for beam monitoring at 100 MHz  
578 rates. Using carbon ions, both sCVD and pCVD demonstrated excellent  
579 timing results.

580 Consequently, two solutions can be foreseen for the beam tagging ho-  
581 doscope design. The first one may consist in using either four  $4.5 \times 4.5 \times$   
582  $0.5 \text{ mm}^3$  commercially available sCVD diamonds arranged in mosaic or, later  
583 on, large area sCVD diamonds. The second solution may consist in using 20  
584  $\times 20 \times 0.3 \text{ mm}^3$  pCVD mainly dedicated for carbon ion therapy applications.  
585 In both cases, the hodoscope will be made out of double-sided strip sensors.  
586 It will provide the ion transverse position with a precision  $\leq 1 \text{ mm}^2$  (X and  
587 Y strips width). The influence of the segmentation of the metallic contacts  
588 on the timing performance of the device will have to be evaluated while it  
589 will not be possible to use the side-to-side signal summation method. The  
590 next step of the hodoscope development is the assembling of the two selected  
591 diamonds types with front-end electronics currently developed at LPSC for  
592 TOF measurements of prompt-gamma in view of range verification in particle  
593 therapy.

594 **Acknowledgements**

595 The authors would like to acknowledge the ESRF-ID21 beamline for pro-  
596 vision of synchrotron radiation with experiments MI-1243 (2016) and MI-  
597 1285 (2017), and support from the ESRF BCU group for integrating the  
598 triggered readout of the LeCroy DSO into the ID21 SPEC data acquisition  
599 system. This work was supported by Plan Cancer (CLaRyS-UFT project),  
600 the LabEx PRIMES (ANR-11-LABX-0063), FranceHadron (ANR-11-INBS-  
601 0007) and ANR MONODIAM-HE (ANR-089520). The cyclotron Arronax  
602 is supported by CNRS, Inserm, INCa, the Nantes University, the Regional  
603 Council of Pays de la Loire, local authorities, the French government and the  
604 European Union. This work has been, in part, supported by a grant from  
605 the French National Agency for Research called “Investissements d’Avenir”,  
606 Equipex Arronax-Plus noANR-11-EQPX-0004, Labex IRON noANR-11-LABX-  
607 18-01 and ISITE NExT no ANR-16-IDEX-007. It was performed in the frame  
608 of ENSAR2/MediNet network (Horizon2020-654002). The authors are grate-  
609 ful to Matthias Schreck from Augsburg University and Martin Fischer from  
610 Audiatic Augsburg for providing the LPSC laboratory with DOI samples.  
611 Dominique Breton and Jihanne Maalmi from IJC-Lab Orsay and Eric De-  
612 lagnes from CEA Saclay are thanked for their implication in dedicated soft-  
613 ware development and technical support of the WaveCatcher data acquisition  
614 system. SC, MLGM, AB, JC, DD, LGM, AG, AL, SM, OR, FER, and MY  
615 are members of the RD42 collaboration at CERN. The authors would like  
616 to thank the reviewer for his/her useful discussion about the enhancement  
617 of the timing performance of pCVD sensors that improved the quality of the  
618 discussion.

619 **References**

- 620 [1] W. D. Newhauser, R. Zhang, The physics of proton therapy,  
621 Physics in Medicine and Biology 60 (8) (2015) R155–R209.  
622 doi:10.1088/0031-9155/60/8/R155.  
623 URL [http://stacks.iop.org/0031-9155/60/i=8/a=R155?key=  
624 crossref.e17ea27b3e09d2ae08a7471562523fb1](http://stacks.iop.org/0031-9155/60/i=8/a=R155?key=crossref.e17ea27b3e09d2ae08a7471562523fb1)
- 625 [2] D. Schardt, T. Elsässer, D. Schulz-Ertner, Heavy-ion tumor therapy:  
626 Physical and radiobiological benefits, Rev. Mod. Phys. 82 (2010) 383–  
627 425. doi:10.1103/RevModPhys.82.383.  
628 URL <https://link.aps.org/doi/10.1103/RevModPhys.82.383>
- 629 [3] H. Paganetti, Range uncertainties in proton therapy and the role of  
630 Monte Carlo simulations., Physics in Medicine and Biology 57 (11)  
631 (2012) R99—117. doi:10.1088/0031-9155/57/11/R99.  
632 URL <http://dx.doi.org/10.1088/0031-9155/57/11/R99>
- 633 [4] A. C. Knopf, A. Lomax, In vivo proton range verification: A re-  
634 view, Physics in Medicine and Biology 58 (15) (2013) 131–160.  
635 doi:10.1088/0031-9155/58/15/R131.  
636 URL [http://stacks.iop.org/0031-9155/58/i=15/a=R131?key=  
637 crossref.a4dce585277cdd2c3b0331cb1d3e7322](http://stacks.iop.org/0031-9155/58/i=15/a=R131?key=crossref.a4dce585277cdd2c3b0331cb1d3e7322)
- 638 [5] A. C. Kraan, Range verification methods in particle therapy: Underly-  
639 ing physics and Monte Carlo modelling, Frontiers in Oncology 5 (JUN)  
640 (2015) 150. doi:10.3389/fonc.2015.00150.

- 641 [6] J. Krimmer, D. Dauvergne, J. M. Létang, Testa, Prompt-gamma mon-  
642 itoring in hadrontherapy: A review, Nuclear Instruments and Methods  
643 in Physics Research, Section A: Accelerators, Spectrometers, Detectors  
644 and Associated Equipment 878 (2018) 58–73. doi:10.1016/j.nima.  
645 2017.07.063.
- 646 [7] T. Werner, J. Berthold, F. Hueso-González, T. Koegler, J. Petzoldt,  
647 K. Roemer, C. Richter, A. Rinscheid, A. Straessner, W. Enghardt,  
648 G. Pausch, Processing of prompt gamma-ray timing data for proton  
649 range measurements at a clinical beam delivery, Physics in Medicine  
650 and Biology 64 (10) (2019) 105023. doi:10.1088/1361-6560/ab176d.  
651 URL [https://iopscience.iop.org/article/10.1088/1361-6560/  
652 ab176d](https://iopscience.iop.org/article/10.1088/1361-6560/ab176d)
- 653 [8] O. Allegrini, J.-P. Cachemiche, C. Caplan, B. Barlus, X. Chen, S. Cur-  
654 toni, D. Dauvergne, R. Della Negra, M.-L. Gallin-Martel, J. Hérault,  
655 J.-M. Létang, C. Morel, E. Testa, Y. Zoccarato, Characterization of a  
656 beam tagging hodoscope for hadrontherapy monitoring, Journal of In-  
657 strumentation Accepted manuscript (2020).
- 658 [9] C. Golnik, F. Hueso-González, A. Müller, P. Dendooven, W. Enghardt,  
659 F. Fiedler, T. Kormoll, K. Roemer, J. Petzoldt, A. Wagner, G. Pausch,  
660 Range assessment in particle therapy based on prompt  $\gamma$ -ray timing  
661 measurements, Physics in Medicine and Biology 59 (18) (2014) 5399–  
662 5422. doi:10.1088/0031-9155/59/18/5399.  
663 URL [http://stacks.iop.org/0031-9155/59/i=18/a=5399?key=  
664 crossref.5437fcd3059992135ec2113679c7dad6](http://stacks.iop.org/0031-9155/59/i=18/a=5399?key=crossref.5437fcd3059992135ec2113679c7dad6)

- 665 [10] F. Hueso-González, W. Enghardt, F. Fiedler, C. Golnik, G. Janssens,  
666 J. Petzoldt, D. Prieels, M. Priegnitz, K. E. Römer, J. Smeets, F. Vander  
667 Stappen, A. Wagner, G. Pausch, First test of the prompt gamma ray  
668 timing method with heterogeneous targets at a clinical proton therapy  
669 facility, *Physics in Medicine and Biology* 60 (16) (2015) 6247–6272.  
670 doi:10.1088/0031-9155/60/16/6247.  
671 URL [http://stacks.iop.org/0031-9155/60/i=16/a=6247?key=  
672 crossref.3382b95c39af8f8ab69e65cd74102dff](http://stacks.iop.org/0031-9155/60/i=16/a=6247?key=crossref.3382b95c39af8f8ab69e65cd74102dff)
- 673 [11] S. Marcatili, J. Collot, S. Curtoni, D. Dauvergne, J.-Y. Hostachy,  
674 C. Koumeir, J. M. Létang, J. Livingstone, V. Métivier, L. Gallin-Martel,  
675 M. L. Gallin-Martel, J. F. Muraz, N. Servagent, É. Testa, M. Yamouni,  
676 Ultra-fast prompt gamma detection in single proton counting regime for  
677 range monitoring in particle therapy, *Physics in Medicine & Biology*  
678 65 (24) (2020) 245033. doi:10.1088/1361-6560/ab7a6c.  
679 URL <https://doi.org/10.1088/1361-6560/ab7a6c>
- 680 [12] D. Dauvergne, O. Allegrini, C. Caplan, X. Chen, S. Curtoni,  
681 A. Etxebeste, M.-L. Gallin-Martel, M. Jacquet, J. M. Létang, J. Liv-  
682 ingtonstone, S. Marcatili, C. Morel, E. Testa, Y. Zoccarato, On the Role  
683 of Single Particle Irradiation and Fast Timing for Efficient Online-  
684 Control in Particle Therapy, *Frontiers in Physics* 8 (2020) 434. doi:  
685 10.3389/fphy.2020.567215.  
686 URL [https://www.frontiersin.org/article/10.3389/fphy.2020.  
687 567215](https://www.frontiersin.org/article/10.3389/fphy.2020.567215)
- 688 [13] A. Vignati, V. Monaco, A. Attili, N. Cartiglia, M. Donetti, M. F. Maz-

689 inani, F. Fausti, M. Ferrero, S. Giordanengo, O. H. Ali, M. Mandur-  
690 rino, L. Manganaro, M. Ferrero, G. Mazza, R. Sacchi, V. Sola, A. Sta-  
691 iano, R. Cirio, Innovative thin silicon detectors for monitoring of thera-  
692 peutic proton beams: preliminary beam tests, *Journal of Instrumenta-*  
693 *tion* 12 (12) (2017) C12056–C12056. doi:10.1088/1748-0221/12/12/  
694 c12056.

695 URL <https://doi.org/10.1088/1748-0221/12/12/c12056>

696 [14] L. Federici, G. Aglieri Rinella, D. Alvarez Feito, R. Arcidiacono,  
697 C. Biino, S. Bonacini, A. Ceccucci, S. Chiozzi, E. Cortina Gil,  
698 A. Cotta Ramusino, J. Degrange, M. Fiorini, E. Gamberini, A. Gianoli,  
699 J. Kaplon, A. Kleimenova, A. Kluge, A. Mapelli, F. Marchetto,  
700 E. Migliore, E. Minucci, M. Morel, J. Noël, M. Noy, L. Perktold,  
701 M. Perrin-Terrin, P. Petagna, F. Petrucci, K. Poltorak, G. Romagnoli,  
702 G. Ruggiero, B. Velghe, H. Wahl, The Gigatracker, the silicon beam  
703 tracker for the NA62 experiment at CERN, *Nuclear Instruments*  
704 *and Methods in Physics Research Section A: Accelerators, Spec-*  
705 *trometers, Detectors and Associated Equipment* 958 (2020) 162127,  
706 proceedings of the Vienna Conference on Instrumentation 2019.  
707 doi:<https://doi.org/10.1016/j.nima.2019.04.081>.

708 URL <http://www.sciencedirect.com/science/article/pii/S0168900219305637>

710 [15] E. Bossini, N. Minafra, Diamond Detectors for Timing Measurements  
711 in High Energy Physics, *Frontiers in Physics* 8 (2020) 248. doi:  
712 10.3389/fphy.2020.00248.



- 713 URL [https://www.frontiersin.org/article/10.3389/fphy.2020.](https://www.frontiersin.org/article/10.3389/fphy.2020.00248)  
714 00248
- 715 [16] M. Pomorski, E. Berdermann, A. Caragheorgheopol, M. Ciobanu,  
716 M. Kiš, A. Martemiyarov, C. Nebel, P. Moritz, Development of single-  
717 crystal CVD-diamond detectors for spectroscopy and timing, *Physica*  
718 *Status Solidi (A) Applications and Materials Science* 203 (12) (2006)  
719 3152–3160. doi:10.1002/pssa.200671127.
- 720 [17] Element6, <https://e6cvd.com//application/quantum-radiation.html>.
- 721 [18] II-VI Inc., <https://ii-vi.com/product/cvd-diamond-substrates/>.
- 722 [19] US Applied Diamond Inc., <http://usapplieddiamond.com/products/>.
- 723 [20] Augsburg diamond technology gmbh (audiatec),  
724 <https://www.audiatec.de/>.
- 725 [21] M. L. Gallin-Martel, A. Bes, A. Boukhémiri, G. Bosson, J. Col-  
726 lot, D. Dauvergne, M. Fontana, L. Gallin-Martel, A. Gorecki, J. Y.  
727 Hostachy, J. Krimmer, A. Lacoste, S. Marcatili, J. Morse, J. F. Mu-  
728 raz, F. E. Rarbi, O. Rossetto, M. Salomé, E. Testa, M. Yamouni,  
729 Large area polycrystalline diamond detectors for online hadron ther-  
730 apy beam tagging applications, in: 2016 IEEE Nuclear Science Symposi-  
731 um, Medical Imaging Conference and Room-Temperature Semicon-  
732 ductor Detector Workshop (NSS/MIC/RTSD), 2016, pp. 1–5. doi:  
733 10.1109/NSSMIC.2016.8069398.  
734 URL <https://doi.org/10.1109/NSSMIC.2016.8069398>

- 735 [22] M. L. Gallin-Martel, L. Abbassi, A. Bes, G. Bosson, J. Collot, T. Crozes,  
736 S. Curtoni, D. Dauvergne, W. De Nolf, M. Fontana, L. Gallin-Martel,  
737 J. Y. Hostachy, J. Krimmer, A. Lacoste, S. Marcatili, J. Morse, J. F.  
738 Motte, J. F. Muraz, F. E. Rarbi, O. Rossetto, M. Salomé, Testa,  
739 R. Vuiart, M. Yamouni, A large area diamond-based beam tagging  
740 hodoscope for ion therapy monitoring, in: EPJ Web of Conferences,  
741 Vol. 170, EDP Sciences, 2018, p. 09005. doi:10.1051/epjconf/  
742 201817009005.
- 743 [23] A. Lacoste, T. Lagarde, S. B. chu, Y. Arnal, J. Pelletier, Multi-  
744 dipolar plasmas for uniform processing: physics, design and perfor-  
745 mance, Plasma Sources Science and Technology 11 (4) (2002) 407–412.  
746 doi:10.1088/0963-0252/11/4/307.  
747 URL <https://doi.org/10.1088/0963-0252/11/4/307>
- 748 [24] CIVIDEC Instrumentation, <https://cividec.at/>.
- 749 [25] D. Breton, E. Delagnes, J. Maalmi, P. Rusquart, The WaveCatcher  
750 family of SCA-based 12-bit 3.2-GS/s fast digitizers, in: 2014 19th IEEE-  
751 NPSS Real Time Conference, RT 2014 - Conference Records, Institute  
752 of Electrical and Electronics Engineers Inc., 2015. doi:10.1109/RTC.  
753 2014.7097545.
- 754 [26] F. Poirier, S. Girault, S. Auduc, C. Huet, E. Mace, J. L. Delvaux,  
755 F. Haddad, The C70 ARRONAX and beam lines status, in: IPAC 2011 -  
756 2nd International Particle Accelerator Conference, 2011, pp. 2661–2663.
- 757 [27] F. Poirier, S. Girault, F. B. Harel, J. B. Etienne, X. Goiziou,

- 758 F. Gomez, A. Herbert, L. Lamouric, D. Poyac, H. Trichet, C. Huet,  
759 E. Mace, Studies and Upgrades on the C70 Cyclotron Arronax, in:  
760 Proceedings of Cyclotrons 2016, 2016, pp. 235–237. doi:10.18429/  
761 JACoW-Cyclotrons2016-TUD02.  
762 URL <http://jacow.org/cyclotrons2016/papers/tud02.pdf>
- 763 [28] P. Moritz, E. Berdermann, K. Blasche, H. Stelzer, B. Voss, Broadband  
764 electronics for CVD-diamond detectors, Diamond and Related Materials  
765 10 (9-10) (2001) 1765–1769. doi:10.1016/S0925-9635(01)00434-4.
- 766 [29] M. Berretti, E. Bossini, N. Minafra, Timing performance of diamond  
767 detectors with Charge Sensitive Amplifier readout, Tech. Rep. Septem-  
768 ber, CERN (2015).  
769 URL <http://cds.cern.ch/record/2055747?ln=fr>
- 770 [30] M. Cotte, E. Pouyet, M. Salomé, C. Rivard, W. De Nolf, H. Castillo-  
771 Michel, T. Fabris, L. Monico, K. Janssens, T. Wang, P. Sciau, L. Verger,  
772 L. Cormier, O. Dargaud, E. Brun, D. Bugnazet, B. Fayard, B. Hesse,  
773 A. E. Pradas del Real, G. Veronesi, J. Langlois, N. Balcar, Y. Van-  
774 denberghe, V. A. Solé, J. Kieffer, R. Barrett, C. Cohen, C. Cornu,  
775 R. Baker, E. Gagliardini, E. Papillon, J. Susini, The ID21 x-ray and  
776 infrared microscopy beamline at the ESRF: status and recent applica-  
777 tions to artistic materials, J. Anal. At. Spectrom. 32 (2017) 477–493.  
778 doi:10.1039/C6JA00356G.  
779 URL <http://dx.doi.org/10.1039/C6JA00356G>
- 780 [31] M.-L. Gallin-Martel, S. Curtoni, S. Marcatili, L. Abbassi, A. Bes,  
781 G. Bosson, J. Collot, T. Crozes, D. Dauvergne, W. De Nolf,

- 782 M. Fontana, L. Gallin-Martel, A. Ghimouz, J.-Y. Hostachy, A. La-  
783 coste, J. Morse, J.-F. Motte, J.-F. Muraz, F. Rarbi, O. Ros-  
784 setto, M. Salomé, E. Testa, M. Yamouni, X-ray Beam Induced  
785 Current analysis of CVD diamond detectors in the perspec-  
786 tive of a beam tagging hodoscope development for hadronther-  
787 apy on-line monitoring, *Diamond and Related Materials* (2020)  
788 108236doi:<https://doi.org/10.1016/j.diamond.2020.108236>.  
789 URL [http://www.sciencedirect.com/science/article/pii/](http://www.sciencedirect.com/science/article/pii/S0925963520307913)  
790 [S0925963520307913](http://www.sciencedirect.com/science/article/pii/S0925963520307913)
- 791 [32] M. Berger, J. Hubbell, S. Seltzer, J. Chang, J. Coursey, R. Sukumar,  
792 D. Zucker, K. Olsen, XCOM: Photon Cross Section Database (2010).  
793 doi:<https://dx.doi.org/10.18434/T48G6X>.  
794 URL <https://www.nist.gov/pml/xcom-photon-cross-sections-database>
- 795 [33] H. Frais-Kölbl, E. Griesmayer, H. Kagan, H. Pernegger, A fast low-noise  
796 charged-particle CVD diamond detector, *IEEE Transactions on Nuclear*  
797 *Science* 51 (6 III) (2004) 3833–3837. doi:10.1109/TNS.2004.839366.
- 798 [34] M. Ciobanu, E. Berdermann, N. Herrmann, K. D. Hildenbrand,  
799 M. Kiš, W. Koenig, J. Pietraszko, M. Pomorski, M. Rebisz-Pomorska,  
800 A. Schüttauf, In-beam diamond start detectors, *IEEE Transactions on*  
801 *Nuclear Science* 58 (4 PART 2) (2011) 2073–2083. doi:10.1109/TNS.  
802 2011.2160282.
- 803 [35] J. F. Ziegler, M. D. Ziegler, J. P. Biersack, SRIM - The stopping and  
804 range of ions in matter (2010), *Nuclear Instruments and Methods in*  
805 *Physics Research, Section B: Beam Interactions with Materials and*

806 Atoms 268 (11-12) (2010) 1818–1823. doi:10.1016/j.nimb.2010.02.  
807 091.

808 [36] S. Curtoni, Development of a diamond beam-tagging hodoscope demon-  
809 strator for online ion range verification in hadrontherapy, Ph.D. thesis,  
810 Université Grenoble-Alpes (2020).