



HAL
open science

Experimental determination of ignition and combustion characteristics of insensitive gun propellants based on RDX and nitrocellulose

Léo Courty, Philippe Gillard, Jordan Ehrhardt, Barbara Baschung

► To cite this version:

Léo Courty, Philippe Gillard, Jordan Ehrhardt, Barbara Baschung. Experimental determination of ignition and combustion characteristics of insensitive gun propellants based on RDX and nitrocellulose. *Combustion and Flame*, 2021, 229 (4), pp.111402. 10.1016/j.combustflame.2021.111402 . hal-03219875

HAL Id: hal-03219875

<https://hal.science/hal-03219875>

Submitted on 22 Mar 2023

HAL is a multi-disciplinary open access archive for the deposit and dissemination of scientific research documents, whether they are published or not. The documents may come from teaching and research institutions in France or abroad, or from public or private research centers.

L'archive ouverte pluridisciplinaire **HAL**, est destinée au dépôt et à la diffusion de documents scientifiques de niveau recherche, publiés ou non, émanant des établissements d'enseignement et de recherche français ou étrangers, des laboratoires publics ou privés.



Distributed under a Creative Commons Attribution - NonCommercial 4.0 International License

Experimental Determination of Ignition and Combustion Characteristics of Insensitive Gun Propellants Based on RDX and Nitrocellulose

Léo Courty^{1,*}, Philippe Gillard¹, Jordan Ehrhardt^{1,2}, Barbara Baschung²

¹ Univ. Orleans, INSA-CVL, PRISME EA 4229, Bourges, France

² French-German Research Institute of Saint-Louis, Saint-Louis, France

*Address correspondence to Léo COURTY, Laboratoire PRISME, IUT de Bourges, 63

Avenue de Lattre de Tassigny, 18020 Bourges, France.

E-mail: leo.courty@univ-orleans.fr

Phone: +33 686 508 443

Abstract

Safety improvements in the field of energetic materials led to the development of insensitive gun propellants. This article deals with ignition and combustion parameters of two commercial insensitive propellants, respectively based on RDX and nitrocellulose. Ignition is obtained thanks to a laser diode and ignition probabilities are given, along with ignition delays, overpressures and propagation rates. Experiments are performed under nitrogen and argon atmospheres, with initial pressures ranging between 10 and 70 bar and laser powers between 0.66 and 9.95 W. It is found that argon enhances combustion, especially on overpressures but not on ignition delays that are more sensitive to laser powers. Nitrocellulose-based propellants are found to be more reactive than RDX-based ones. Results on graphitized laboratory gun propellants based on the same materials are also given to discuss the results.

1. Introduction

Safety improvements in the field of energetic materials led to the development of insensitive gun propellants. These materials belong to the family of LOW-Vulnerability Ammunition (LOVA). Security in the logistic phases (storage, transport) is much better with such insensitive propellants since they are expected to be insensitive to accidental ignition stimuli such as electrostatic discharge, heat, shock, friction or mechanical impact. Nevertheless, due to this insensitivity, their use in operational conditions remains a challenge. The study of their ignition behavior is therefore fundamental. Present article deals with laser ignition of two insensitive propellants. Ignition is obtained thanks to thermal energy deposition on the material surface using a laser diode.

This technique is a promising alternative to the classical pyrotechnic ignition devices, allowing the deposition of sufficient energy to compensate for sensitivity loss. Moreover, laser ignition allows a precise location of the ignition point and few thermal losses, that is also in favor of security improvement. First studies on laser ignition of energetic materials were performed by Brish et al. [1] in the 60s, but this technique is still widely present in the literature [2,3].

Two insensitive propellants are studied in this work. The first one is mainly composed of nitrocellulose (~98%) and the second one of RDX (1,3,5-trinitrohexahydro-s-triazine, ~84%). These two compounds are explosives but melted with other substances they become low-vulnerability propellants. There are some recent works in the literature dealing with decomposition [4] and laser sensitivity [5] of RDX or degradation of nitrocellulose [6]. Nevertheless, there is a lack of data on ignition behavior and combustion characteristics of these insensitive propellants. Note that several recent works focused on ignition of RDX mixed with nanoparticles of gold [7] or aluminum [8]. We recently published [9,10]

separately studies on ignition and combustion of these two propellants. The aim of the present paper is to compare their behavior, and therefore to increase literature database on RDX and nitrocellulose combustion.

Detailed studies on insensitive propellants combustion is of interest for the field of internal ballistics, for system performances but also for security of property and people. Experimental setup and energetic materials used are presented in the next section. Section three is devoted to the presentation of results and discussions.

2. Experimental details and methodology

Energetic materials used and experimental setup are presented in this section.

We worked with commercial gun propellants provided by ArianeGroup and used as received. Experiments were performed with two kinds of propellants, as stated in the introduction. The first one, called P1, has a cylindrical shape and is composed of nitrocellulose (~98 %) and diphenylamine (~1.2 %). Note that this incomplete composition is the one given in the safety data sheet (commercial gun propellant). Cylinders respective average lengths, masses and diameters are 11.4 mm, 355 mg and 5.4 mm. Each cylinder is perforated with 7 holes. Two pictures of this propellant P1 are presented in Figure 1.

Second propellant, called P2, also has a cylindrical shape perforated with 7 holes and is composed of RDX (~84 %) and a binder (~16 %). This binder is mainly composed of HTPB (hydroxyl-terminated polybutadiene). Average length, mass and diameter of P2 are respectively of 3.8 mm, 26 mg et 2.7 mm. SEM (Scanning Electron Microscopy) pictures of P2 pellets are presented in Figure 2.

Both propellants are dark in color, ensuring a good laser-material coupling.

For sake of comparison and discussions on ignition thresholds, results on other gun propellants (P3 and P4) made of RDX and nitrocellulose are given here. These laboratory propellants (different from P1 and P2 that are commercial) are made of RDX (94.7 %), NC (5 %) and Centralit I (0.3 %). P3 is only composed of RDX, nitrocellulose and Centralit I, is white in color and was studied in [17]. P4 has the same composition as P3 and is graphitized in surface thanks to a rotary mechanical stirring. Mass content of graphite in P4 is of 0.3 %.

P3 and P4 were made at the French-German Research Institute of Saint-Louis (France). Three steps are necessary: mixing, extrusion and cutting. The first part of the process is to mix in a tank NC, RDX and Centralit I. An organic solvent is added to obtain a homogeneous mixture. Since the solvent has an influence on the quality of the extrusion, the quantity and the nature of the used organic solvent are very important. After several tests, P3 and P4 were made using a mixture of acetone (95 %) and ethyl acetate (5 %). All compounds are mixed in the tank for two hours. Then, the obtained pasted is placed into a 50 cm³ syringe for the extrusion process. The extrusion is considered as successful when the required tubular shape is obtained. Obtained propellants are 10 cm long after the extrusion process: a blade is used to cut samples with a length of 5 mm.

Composition of the four studied gun propellants is summarized in Table 1.

Table 1. Composition of the four studied gun propellants: P1, P2, P3 and P4.

Gun propellant	Mass % of RDX	Mass % of nitrocellulose	Graphite
P1	x	~ 98	yes
P2	~84 %	x	yes
P3	94.7	5	no
P4	94.7	5	yes

Experiments were performed in a stainless steel cylindrical closed-volume vessel (internal volume of 55 cm³), using a laser diode (Coherent FAP System operating at a wavelength of 808 nm) for ignition. A schematic overview of the setup is presented in Figure 3. Detailed

presentations of the experimental setup and used methodology can be found in Gillard et al. [9] and Courty et al. [10]. To remove discrepancies due to air humidity and improve tests reproducibility, materials were heated at 50 °C during 24 hours before tests.

Insensitive gun propellants cannot be ignited without applying a minimal initial pressure, even with the highest laser power (15 W) that leads only to pyrolysis at atmospheric pressure. These initial pressures were obtained using two gaseous atmospheres: nitrogen or argon. Initial pressures were varied between 10 and 70 bar for both gases. Laser powers could be varied changing diode current intensity for a given temperature (20 °C here). Different laser powers were investigated: 0.66, 1.43, 2.86, 5.00, 6.42 and 9,95 W. The diameter of the laser spot is kept at 1.25 mm. In such conditions, heat flux densities vary between $5.38 \cdot 10^{-2}$ and $8.11 \cdot 10^{-1}$ kW/cm².

As explained in detail in [9] and [10], overpressures and ignition delays are obtained thanks to the pressure signals as functions of time. Propagation rate is defined as:

$$\frac{1}{m} \cdot \left(\frac{d\Delta P}{dt} \right)_{max} \quad (1)$$

with m the initial mass of the sample and ΔP the overpressure (final pressure minus initial one) obtained after propellant combustion. In terms of safety, burning rate is a key parameter for the design of protection means. It is representative of dynamic vivacity. The propagation rate is used for dimensioning venting of closed vessels where an explosion is possible.

Ignition probabilities as functions of deposited energies are studied for different laser powers. Energies giving an ignition probability of 50 % (E_{50}) are investigated using the modified Langlie method [11]. Thanks to this method, E_{50} values can be obtained with 20 to 30 shots. Used methodology is illustrated in Figure 4 for the example of P2 under N₂, with a laser power of 2.86 W and an initial pressure of 50 bar.

3. Results and discussions

Results presented here are ignition delays t_i , overpressures ΔP , propagation rates defined in the previous section and ignition energies. Effect of initial pressure on these combustion parameters has already been widely presented and discussed in previous works [9,10], we therefore focus in the present paper on laser power effect for the two propellants, for shots at an initial pressure of 50 bar.

3.1 Ignition delays

Figures 5a and 5b present ignition delays as functions of laser power for an initial pressure of 50 bar. We can notice on these figures that ignition delays are decreasing when laser powers are increasing. This is valid for both propellants and both gaseous atmospheres. This effect of laser power is very important for low powers, up to a critical power around 3 W. Effect of surrounding gaseous atmosphere is very low on ignition delay. Ignition delays are lower for P1 than for P2, which show that nitrocellulose-based propellants are more reactive than RDX-based ones. Ignition delays of P1 are about 50 ms inferior to the ones of P2 for the two studied atmospheres. Similar tendency of t_i vs. laser power was recently observed in the literature by Li et al. [13] who worked with aluminum-magnesium fuel-rich propellants using a CO₂ laser for ignition. Ulas and Kuo [14] also noticed such tendencies for propellants containing RDX. They have not noticed the existence of a critical power above which delays are almost constant but experimental configuration and ignition sources were totally different.

Note that measured ignition delays are the sum of three different times: physical heating time (t_h) due to laser coupling with the heated material; pyrolysis time (t_p) and gas production; chemical time (t_c) to ignite pyrolysis gaseous products. Chemical times t_c were estimated for pure RDX (Mar et al. [15]) that gives a comparison with P2 (84 % of RDX). These chemical

times were highly dependent on initial temperature: from 45 ms at 600 K to 0.023 ms at 1000 K. Ignition delays measured in the present work are between 100 and 600 ms, which means that t_c is very low compared to the other times. Ignition is limited by the preliminary phases of heating and pyrolysis.

3.2 Overpressures

To overcome samples initial mass variation, overpressures presented are divided by sample initial mass. Figures 6a and 6b present overpressures as functions of laser power for an initial pressure of 50 bar. We can see in these Figures that, contrary to ignition delays, laser power effect is very low on obtained overpressures. This can be explained because once the combustion has started (release of gases responsible of overpressures), phenomena are independent from ignition source properties. Nevertheless, they are very dependent from middle properties. Therefore, gaseous atmosphere composition widely affects overpressures, as it can be noticed in these Figures. Obtained overpressures are higher in Ar than in N₂. As mentioned several times [9,10], nitrogen can be seen as a combustion inhibitor for these kinds of propellants.

A thermal explanation based on equilibrium calculations has been given to explain combustion differences under nitrogen and argon. Since the final pressure is mainly governed by the final temperature, the higher the adiabatic temperature is, the higher the final pressure will be. The adiabatic temperature is related to the thermal property of Ar or N₂ and molar heat capacity for a constant volume of argon is lower than that of nitrogen. Therefore, for a similar initial pressure, the final pressure will be greater in argon atmosphere than in nitrogen atmosphere.

Equilibrium calculations were performed using the EQUIL program of CHEMKIN-PRO. Calculations were carried out assuming that the gas phase is a mixture of ideal gases and under the hypotheses of isochoric and adiabatic conditions. Calculations were performed for pure RDX using all the species included in the Yetter al. [12] mechanism. Simulations were performed for an initial pressure of 50 bar and an initial temperature of 2000 K and several initial masses (corresponding to the performed experiments) were studied. Results for adiabatic flame temperatures are presented in Table 2. It is clear in this Table that obtained adiabatic flame temperatures are higher under Ar than under N₂, leading to higher overpressures.

Table 2. Adiabatic flame temperatures obtained by equilibrium calculations under Ar and N₂ atmospheres.

Initial mass (mg)	Adiabatic flame temperature under Ar atmosphere (K)	Adiabatic flame temperature under N₂ atmosphere (K)
16.5	2441.4	2268.4
26.9	2356.1	2214.2
55.4	2238.5	2141.4
93.8	2144.8	2085.0
145.4	2071.8	2041.8
185.5	2044.4	2025.4

This thermal explanation was given in [9] under the assumption of same composition of the final gas phase. Nevertheless, there can also be a chemical explanation. Indeed, it has been shown in a recent work [17] that emitted pyrolysis species can be different under N₂ or Ar

atmospheres (especially concerning hydrogen cyanide). Further works still need to be performed to completely explain different behaviors under Ar or N₂ atmospheres.

We can also note looking at Figures 6a and 6b that overpressures obtained for P1 are higher than the ones obtained for P2, for both gaseous atmospheres and all laser powers. Nitrocellulose-based propellant is therefore more efficient, in terms of gases emission, than RDX-based one.

Figure 7 presents the obtained overpressures for different initial masses of P2. Experimental results are confronted to equilibrium calculations (adiabatic flame temperatures are presented in Table 2 and calculated overpressures in Figure 7). One can see in this Figure that the linear relation is very good between pressure and propellant mass m . Obtained regressions are $\Delta P = 0.0993 m - 0.1533$ ($R^2 = 0.9942$) for nitrogen and $\Delta P = 0.1441 m - 0.8004$ ($R^2 = 0.9957$) for argon. It is also clear in this Figure that equilibrium calculations are very close to experimental values (for a calculation initial temperature of 2000 K).

3.3 Propagation rates

Figures 8a and 8b present propagation rates as functions of laser power for an initial pressure of 50 bar. It is clear reading these Figures that RDX-based propellant P2 is much less reactive than nitrocellulose-based one P1. Propagation rate values are on average two times higher for P1.

Similarly to overpressures, effect of laser power on propagation rate is very low. This can be explained because propagation rate is a characteristic of established combustion, independent from ignition source properties. On the contrary, propagation rate is very affected by gaseous atmosphere. We can notice that combustion in Ar is faster than in N₂. P1 and P2 burn respectively 1.4 and 1.5 times faster in Ar than in N₂. Again, argon can be seen as a combustion enhancer for these kinds of propellants.

For sake of comparison, results of propagation rates are also presented in Figure 8 as functions of initial pressure.

We can see in Figure 9 that, similarly to Figure 8, propagation rates are higher for P1 than for P2 and that values are higher under argon atmosphere than under nitrogen atmosphere. As expected, propagation rates are increasing when initial pressures are increasing. Nevertheless, we can notice an unexpected behavior between 40 and 50 bar, where propagation rates can temporarily decrease. This is valid for the two propellants and for the two atmospheres. This unexpected behavior between 40 and 50 bar was also noticed for overpressure as a function of initial pressure [9, 10]. Deeper studies on thermal degradation and kinetics should be performed to explain in detail this behavior.

3.4 Ignition probabilities

Energies giving a probability of ignition of 50 % for the two studied propellants P1 and P2 under both atmospheres are presented in Tables 3 (under argon atmosphere) and 4 (under nitrogen atmosphere), along with their standard deviations σ .

Table 3. E_{50} and their corresponding standard deviations for both propellants under argon atmosphere (initial pressure of 50 bar).

Laser Power (W)	Heat Flux Density (kW.cm ⁻²)	P1		P2	
		E_{50} (mJ)	σ (mJ)	E_{50} (mJ)	σ (mJ)
0.66	$5.38 \cdot 10^{-2}$	306.58	13.37	no ignition	no ignition
1.43	$1.17 \cdot 10^{-1}$	199.90	23.56	169.20	5.81
2.86	$2.33 \cdot 10^{-1}$	97.96	37.03	110.60	21.19

5.00	$4.07 \cdot 10^{-1}$	non-tested	non-tested	92.63	6.41
6.42	$5.23 \cdot 10^{-1}$	non-tested	non-tested	80.96	5.64
9.95	$8.11 \cdot 10^{-1}$	44.02	18.06	79.59	4.21

Table 4. E_{50} and their corresponding standard deviations for both propellants under nitrogen atmosphere (initial pressure of 50 bar).

Laser Power (W)	Heat Flux Density (kW.cm ⁻²)	P1		P2	
		E_{50} (mJ)	σ (mJ)	E_{50} (mJ)	σ (mJ)
0.66	$5.38 \cdot 10^{-2}$	363.90	23.94	no ignition	no ignition
1.43	$1.17 \cdot 10^{-1}$	193.97	6.06	170.14	17.77
2.86	$2.33 \cdot 10^{-1}$	119.90	23.83	119.18	9.99
5.00	$4.07 \cdot 10^{-1}$	non-tested	non-tested	107.65	5.01
6.42	$5.23 \cdot 10^{-1}$	non-tested	non-tested	93.14	6.42
9.95	$8.11 \cdot 10^{-1}$	36.89	11.35	79.22	1.70

Experiments were performed for an initial pressure of 50 bars. E_{50} is an ignition characteristic in relation with ignition sensibility, like ignition delay: effect of laser power on this parameter is therefore of importance. Like ignition delay, there is the existence of a critical power (same value, around 3 W). Below this power, P1 needs more energy than P2 to be ignited and above this power it is easier to ignite NC-based propellant P1. It can be noticed that standard deviations obtained with this method on these gun propellants are lower than those obtained on pyrotechnics compositions [15].

E_{50} is the parameter less affected by propellant nature: values are very close to each other between P1 and P2, especially for low laser powers. It is also the parameter less affected by gaseous atmosphere. Indeed, values are on the same order, especially for low laser powers. For high laser powers, it can even be easier to ignite in nitrogen. For example, P1 needs 1.2 times more energy to be ignited in nitrogen than in argon at 0.66 W, and 1.2 times more energy at 9.95 W to be ignited in argon than in nitrogen.

Note that P1 and P2 pellets are brown in color. It suggests that absorption of incoming laser beam is good with these compositions and penetration depth of laser is low. Therefore, production of heat is located nearby the surface of the pellet and this is why obtained E_{50} are not so high for such insensitive ammunition. Values obtained with white pellets [16] are much more important.

As stated in the ignition delays section, the limited step looks to be the heat released at the pellet surface and not the chemistry. Indeed, even if P1 and P2 composition differs, E_{50} for the two propellants are in the same order of magnitude.

Figure 9 present the obtained E_{50} for P3 (white) and P4 (graphitized) propellants. These values are also given in Tables 5 and 6 with the standard deviations for respectively argon and nitrogen atmospheres.

We can see in Figure 10 that the impact of graphite at the surface of gun propellant is very important in terms of ignition energy. Indeed, the presence of graphite decreases E_{50} values of 96.3 % and 97.7 % for respectively argon and nitrogen atmospheres. Graphite is commonly used to increase ammunitions loading, which is facilitated by reducing friction between grains. Here, the laser beam absorption considerably decreases ignition energy values. However, E_{50} energies for P4 are lower than those obtained for P2 where RDX is the major compound, but also for P1 which is mainly made of nitrocellulose. Addition of graphite is

more important in terms of sensibility for laser ignition than percentage of nitrocellulose. It was shown in a previous study that this energy threshold was decreasing with nitrocellulose content [16]. By combing graphite addition and nitrocellulose/RDX ratio it should be possible to optimize ignition sensibility and performances during combustion, which are better with nitrocellulose addition.

Power delivered by the laser diode through the optical fiber plays an important role in the ignition of gun propellants. It can be noticed for all propellants studied that E_{50} decreases exponentially with power increase. It is also interesting to notice that standard deviations are decreasing when laser power is increasing and are very low compared to results for P1 and P2. This can be explained by the fact that increasing laser power also increase heated volume of propellant. The increase of this heated volume leads to higher reliability and results reproducibility.

Table 5. E_{50} and their corresponding standard deviations for P3 and P4 under argon atmosphere (initial pressure of 50 bar).

Laser Power (W)	Heat Flux Density (kW.cm ⁻²)	P3		P4	
		E_{50} (mJ)	σ (mJ)	E_{50} (mJ)	σ (mJ)
2.91	$2.37 \cdot 10^{-1}$	non-tested	non-tested	50.17	2.95
6.54	$5.33 \cdot 10^{-1}$	4365	765.4	37.57	5.37
8.74	$7.12 \cdot 10^{-1}$	995.9	131.3	non-tested	non-tested
10.13	$8.25 \cdot 10^{-1}$	837.3	416.5	31.64	1.45

Table 6. E_{50} and their corresponding standard deviations for P3 and P4 under nitrogen atmosphere (initial pressure of 50 bar).

Laser Power (W)	Heat Flux Density (kW.cm ⁻²)	P3		P4	
		E ₅₀ (mJ)	σ (mJ)	E ₅₀ (mJ)	σ (mJ)
2.91 W	2.37·10 ⁻¹	non-tested	non-tested	51.61	12.88
6.54 W	5.33·10 ⁻¹	4744	330.1	33.09	3.893
8.74 W	7.12·10 ⁻¹	2098	230.1	non-tested	non-tested
10.13 W	8.25·10 ⁻¹	1834	525.2	43.14	2.78

If we compare ignition energies E₅₀ under Ar obtained for P2 at a fluency of 0.233 kW.cm⁻² with the one obtained for P4 at a comparable fluence (0.237 kW.cm⁻²), it can be seen that it is possible to decrease the ignition energy from 110 to 50 mJ. The same trend is also obtained under nitrogen. These two propellants are prepared with the same amount of RDX (85 % in weight) and the complement for P2 is HTPB and NC for P4. Since both propellants are prepared with comparable graphite addition, the 15 % in weight for P4 of NC could explain why this propellant is the more sensitive of our tested set.

In conclusion, graphite addition therefore acts at the first order in ignition sensibility with respect to laser ignition. The second order is attributed to nitrocellulose and finally RDX is the less sensitive ingredient of these propellants. The fact that graphite is added for industrial making of ammunitions (reduction of friction between grains) is matching with the fact that this addition allows good ignition conditions with a laser diode without using too high laser fluences.

4. Conclusion

Ignition (delays, energies) and combustion (pressures, rates) parameters were investigated for two insensitive commercial propellants. Composition of these two propellants is different, one

is based on nitrocellulose and the other mainly on RDX, and comparisons are thus performed between nitrocellulose and RDX reactivities. Moreover, ignition energy results are also given on laboratory gun propellants graphitized or not.

Ignition parameters are very sensitive to laser power and combustion parameters very sensitive to environment (gaseous atmosphere, argon or nitrogen). Main results are that nitrocellulose-based propellant combustion performances are higher than RDX-based one and argon enhances combustion. In terms of safety, less sensitive gun propellant (P2) is preferable. In terms of performances, P1 is preferable. Results for these two propellant compositions are compared, because in applications an agreement has to be found between safety and performances.

Some preliminary combustion equilibrium calculations on RDX have confirmed that differences on diluent heat capacities are mainly responsible for higher burning rate values under argon. Unfortunately, the lack of thermodynamic data for NC did not allow similar computations for P1 powder. Obtaining these data and the development of a detailed kinetic scheme for nitrocellulose are currently under process.

Heat released at the surface of the pellet looks to be the limiting step during ignition of the two propellants. Even if the composition changes, the similarity in energy thresholds suggest that differences in chemical reactions during first step of ignition are not the most important factors.

In future works, we will study in details differences between nitrocellulose and RDX, using laboratory (not commercial) propellants, where nitrocellulose and RDX rates are chosen and perfectly controlled.

Acknowledgements

Authors want to thank the “Conseil Régional du Centre-Val de Loire”, in France, which has financially supported this work (LILOVEM project). Authors are also thankful to ArianeGroup for the supply of P1 and P2 propellants. Authors also thank the French Direction Générale de l’Armement (DGA) for the supply of P3 and P4 propellants.

References

- [1] A.A. Brish, I.A. Galeev, B.N. Zaitsev, E.A. Sbitnev, L.V. Tatarintsev, Mechanism of initiation of condensed explosives by laser radiation, *Combustion, Explosion and Shock Waves* 5 (1969) 326-328.
- [2] D.N. Herreros, X. Fang, Laser ignition of elastomer-modified cast double-base (EMCDB) propellant using a diode laser, *Optics & Laser Technology* 89 (2017) 21-26.
- [3] S. Churchyard, X. Fang, R. Vrcelj, Laser ignitibility of energetic crystals doped with gold nanoparticles, *Optics and Laser Technology* 113 (2019), 281-288.
- [4] S.H. Kim, B.W. Nyande, H.S. Kim, J.S. Park, W.J. Lee, M. Oh, Numerical analysis of thermal decomposition for RDX, TNT, and Composition B, *Journal of Hazardous Materials* 308 (2016) 120-130.
- [5] Z. Yan, W. Liu, C. Zhang, X. Wang, J. Li, Z. Yang, X. Xiang, M. Huang, B. Tan, G. Zhou, W. Liao, Z. Li, L. Li, H. Yan, X. Yuan, X. Zu, Quantitative correlation between facets defects of RDX crystals and their laser sensitivity, *Journal of Hazardous Materials* 313 (2016) 103-111.
- [6] S. Berthumeyrie, S. Collin, P.O. Bussiere, S. Therias, Photooxidation of cellulose nitrate: New insights into degradation mechanisms, *Journal of Hazardous Materials* 272 (2014) 137-147.

- [7] X. Fang, M. Stone, C. Stennett, Pulsed laser irradiation of a nanoparticles sensitised RDX crystal, *Combustion and Flame* 214 (2020) 387-393.
- [8] B.P. Aduiev, D.R. Nurmukhametov, I.Y. Liskov, A.V. Tupitsyn, G.M. Belokurov, Laser pulse initiation of RDX-Al and PETN-Al composites explosion, *Combustion and Flame* 216 (2020) 468-471.
- [9] P. Gillard, L. Courty, S. De Persis, J.F. Lagrange, C. Boulnois, I. Gökalp, Combustion properties of a low-vulnerability propellant: an experimental and theoretical study using laser ignition, *Journal of energetic materials* 36 (2018) 362-374.
- [10] L. Courty, J.F. Lagrange, P. Gillard, C. Boulnois, Laser ignition of a low vulnerability propellant based on nitrocellulose: effects of Ar and N₂ surrounding atmospheres, *Propellants, Explosives, Pyrotechnics* 43 (2018) 986-991.
- [11] H.J. Langlie, A reliability test method for one shot items, Ford Motor Company Aeronutronic – Publication n° U1792, USA, 1962.
- [12] R.A. Yetter, F.L. Dryer, M.T. Allen, J.L. Gatto, Development of gas-phase reaction mechanisms for nitramine combustion, *Journal of Propulsion and Power* 11 (4) 683-697, 1995.
- [13] L.B. Li, X. Chen, O. Musa, C.S. Zhou, M. Zhu, The effect of pressure and oxygen concentration on the ignition and combustion of aluminum–magnesium fuel-rich propellant, *Aerospace Science and Technology* 76 (2018) 394-401.
- [14] A. Ulas, K.K. Kuo, Laser-induced ignition of solid propellants for gas generators, *Fuel* 87 (2008) 639-646.
- [15] M. Mar, P. Gillard, L. Courty, Numerical simulations of ignition and combustion of RDX mixed with gaseous additives, 25th ICDERS, Leeds, UK, August 2-5 2015.

[16] P. Gillard, F. Opdebeck, Laser diode ignition of the B/KNO₃ pyrotechnic mixture: An experimental study, *Combustion Science and Technology* 179 (2007) 1667-1699.

[17] J. Ehrhardt, L. Courty, P. Gillard, B. Baschung, Experimental study of pyrolysis and laser ignition of low-vulnerability propellants based on RDX, *Molecules* 25 (2020) 2276.

Figures



Figure 1. Pictures of propellant P1 mainly composed of nitrocellulose.

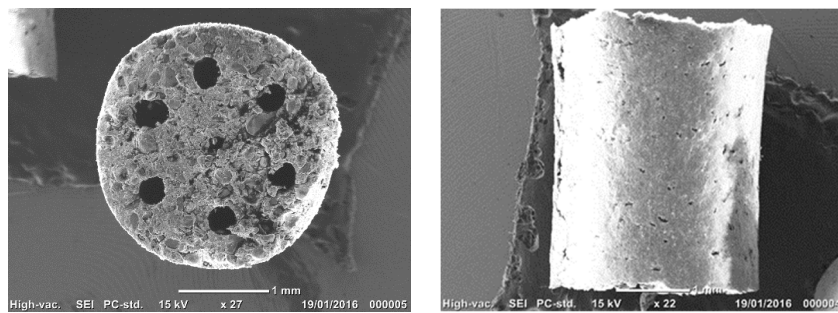

Figure 2. SEM images of propellant P2 mainly composed of RDX.

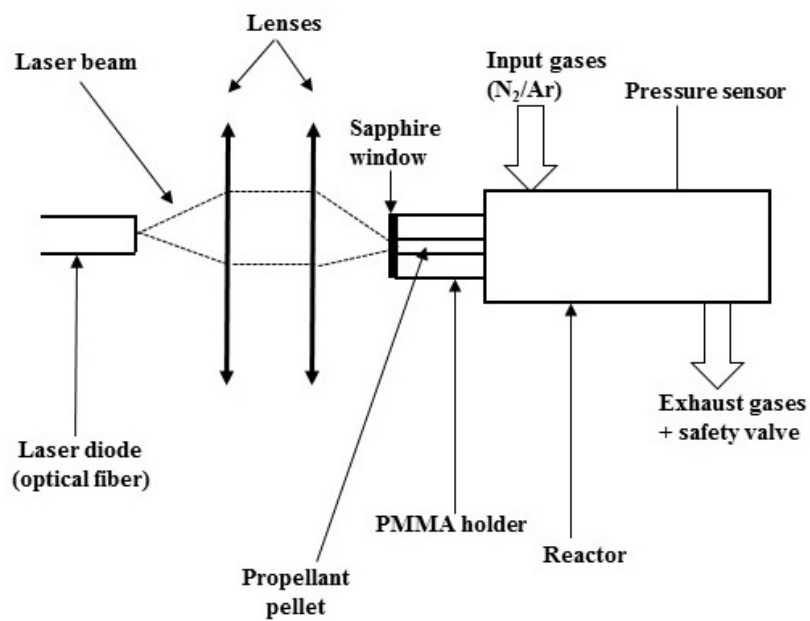

Figure 3. Scheme of the propellant ignition experimental setup.

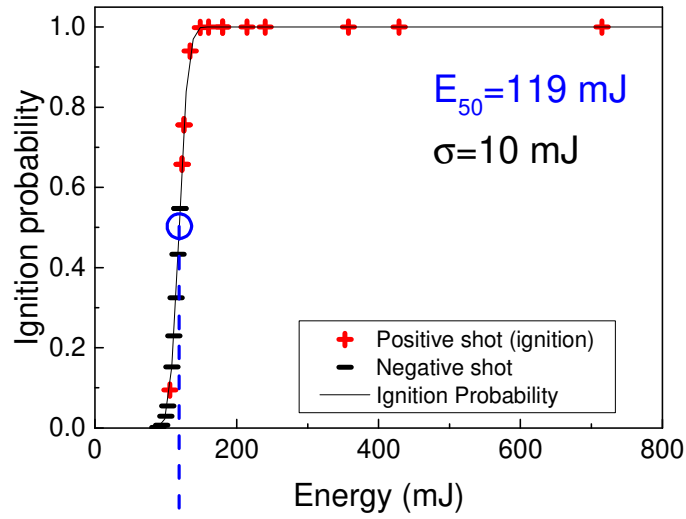

Figure 4. Ignition probabilities as functions of deposited energy for P2 (50 bar of N₂ and laser power of 2.86 W).

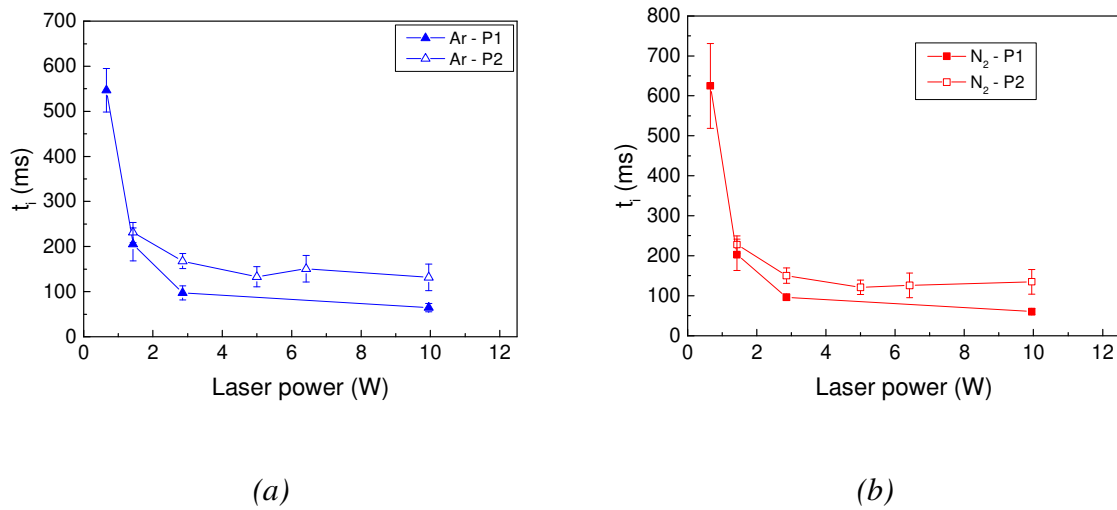
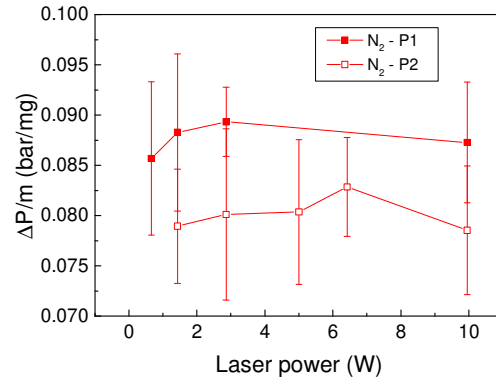
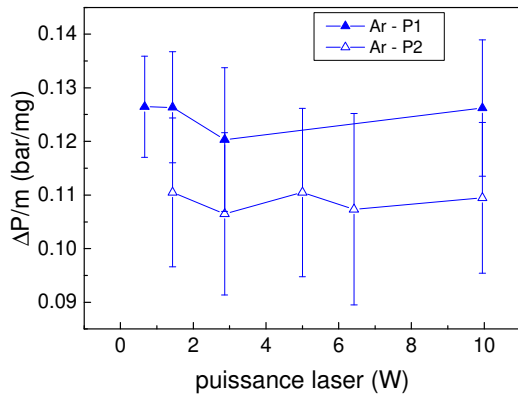

Figure 5. Ignition delays as functions of laser power for P1 and P2 under argon (a) and nitrogen (b) atmospheres.



(a)

(b)

Figure 6. Overpressures as functions of laser power for P1 and P2 under argon (a) and nitrogen (b) atmospheres.

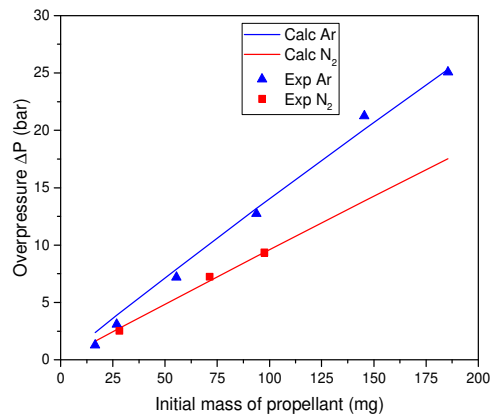
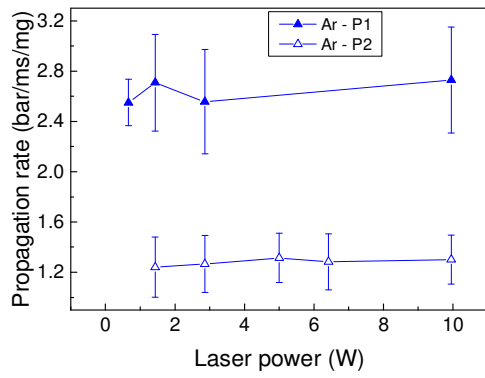
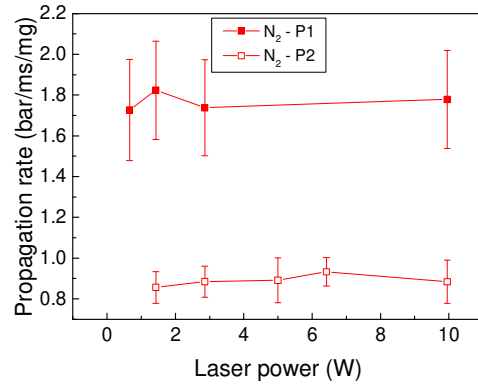

Figure 7. Experimental and calculated (equilibrium) overpressures of P2 as functions of sample initial mass for an initial pressure of 50 bar.



(a)



(b)

Figure 8. Propagation rates as functions of laser power for P1 and P2 under argon (a) and nitrogen (b) atmospheres.

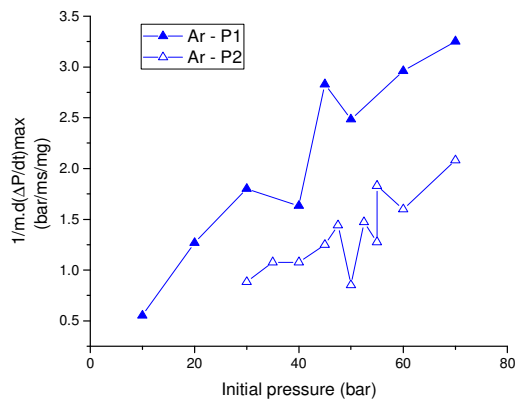

(a)

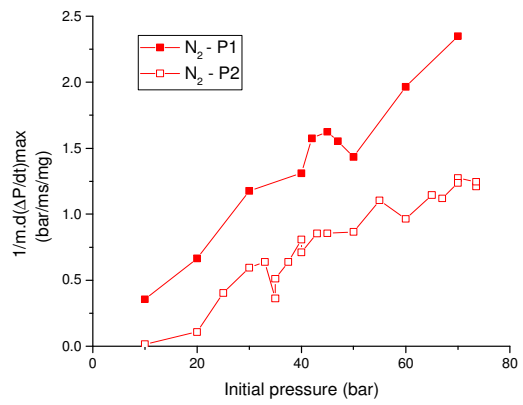

(b)

Figure 9. Propagation rates as functions of initial pressure for P1 and P2 under argon (a) and nitrogen (b) atmospheres.

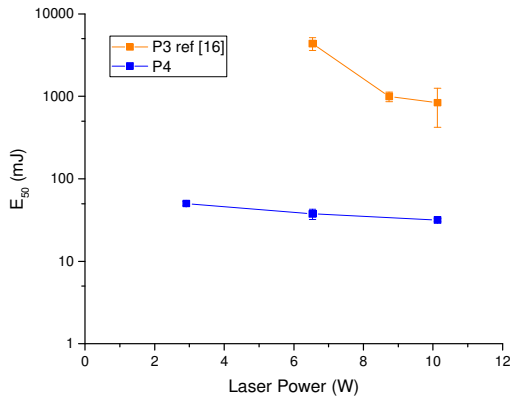

(a)

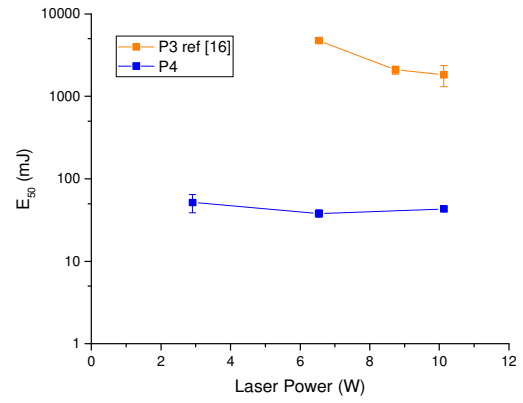

(b)

Figure 10. E_{50} as functions of laser power for a graphitized gun propellant made of 95 % RDX and 5 % NC under argon (a) and nitrogen (b) atmospheres.