



HAL
open science

New prime focus rotator system for the WHT

Ander San Vicente Astobiza, Gaizka Murga Llano, Iñigo Uriarte, David Fernández, Rafa Urrutia, Amaya Múgica, Ramon Campo, Javier Ariño, Lander de Bilbao, Anna Kosmalska, et al.

► **To cite this version:**

Ander San Vicente Astobiza, Gaizka Murga Llano, Iñigo Uriarte, David Fernández, Rafa Urrutia, et al.. New prime focus rotator system for the WHT. Ground-based and Airborne Telescopes VIII, Dec 2020, Online Only, France. pp.146, 10.1117/12.2562638 . hal-03215599

HAL Id: hal-03215599

<https://hal.science/hal-03215599v1>

Submitted on 15 Oct 2021

HAL is a multi-disciplinary open access archive for the deposit and dissemination of scientific research documents, whether they are published or not. The documents may come from teaching and research institutions in France or abroad, or from public or private research centers.

L'archive ouverte pluridisciplinaire **HAL**, est destinée au dépôt et à la diffusion de documents scientifiques de niveau recherche, publiés ou non, émanant des établissements d'enseignement et de recherche français ou étrangers, des laboratoires publics ou privés.

PROCEEDINGS OF SPIE

[SPIDigitalLibrary.org/conference-proceedings-of-spie](https://spiedigitallibrary.org/conference-proceedings-of-spie)

New prime focus rotator system for the WHT

San Vicente , Ander, Murga , Gaizka, Uriarte, Iñigo, Fernández, David, Urrutia, Rafael, et al.

Ander San Vicente , Gaizka Murga , Iñigo Uriarte, David Fernández, Rafael Urrutia, Amaya Mugica, Ramón Campo, Javier Ariño, Lander de Bilbao, Anna Kosmalka, Gavin Dalton, Kevin Middleton, Scott Trager, J. Alfonso L. Aguerri, José Miguel Delgado Hernandez, José Alonso Burgal, José Miguel Herreros, Piercarlo Bonifacio, Antonella Vallenari, Esperanza Carrasco, Don Carlos Abrams, Kevin Dee, Emilie Lhoméh, Frank Gribbin, Jure Skvarc, Carlos Martin, "New prime focus rotator system for the WHT," Proc. SPIE 11445, Ground-based and Airborne Telescopes VIII, 114454S (13 December 2020); doi: 10.1117/12.2562638

SPIE.

Event: SPIE Astronomical Telescopes + Instrumentation, 2020, Online Only

New Prime Focus Rotator System for the WHT

Ander San Vicente^a, Gaizka Murga^a, Iñigo Uriarte^a, David Fernández^a, Rafael Urrutia^a, Amaya Mugica^a, Ramón Campo^a, Javier Ariño^a, Lander de Bilbao^a, Anna Kosmalka^a, Gavin Dalton^b, Kevin Middleton^b, Scott Trager^c, J. Alfonso L. Aguerri^d, José Miguel Delgado Hernandez^d, José Alonso Burgal^d, José Miguel Herreros^d, Piercarlo Bonifacio^e, Antonella Vallenari^f, Esperanza Carrasco^g, Don Carlos Abrams^h, Kevin Dee^h, Emilie Lhoméh^h, Frank Gribbin^h, Jure Skvarc^h, Carlos Martín^h

^aIDOM, Av. Zarandoa 23, 48015 Bilbao, Spain

^bOxford/RALSpace, Fermi Ave, Harwell, Didcot OX11 0QX, Great Britain

^cRUG, PO Box 72, 9700 AB Groningen, the Netherlands

^dInstituto de Astrofísica de Canarias, c/ Via Láctea s/n, 38205 La Laguna, Spain

^eGEPI, 5 Pl Jules Janssen, 92195 Meudon Cedex, France

^fINAF-OAPD, Vicolo Osservatorio 5, 35122 Padova

^gINAOE, Luis Enrique Erro # 1, Santa María Tonatzintla, 72840 Puebla, PUE, México

^hING, Calle Álvarez de Abreu, 70, 38700 Santa Cruz de la Palma, Santa Cruz de Tenerife

ABSTRACT

WEAVE is a new wide-field multi-object spectroscopy (MOS) facility proposed for the prime focus of the 4.2m William Herschel Telescope. The facility comprises a new 2-degree field-of-view Prime Focus Corrector (PFC) with a 1000-multiplex fibre positioner, a small number of individually deployable integral field units, and a large single integral field unit (IFU). The IFUs and the MOS fibres can be used to feed a dual-beam spectrograph that will provide full coverage of the majority of the visible spectrum in a single exposure at a spectral resolution of ~ 5000 or modest wavelength coverage in both arms at a resolution ~ 20000 .

In order to compensate the field rotation, the Prime Focus Rotator (PFR) is assembled in between the WEAVE Fiber Positioner (system that positions the fibers in the focal plane) and with the Central Can (contains the Prime Focus corrector optics) on the William Herschel Telescope (WHT).

The Prime Focus Rotator must provide a rotation degree of freedom for the Fibre Positioner with a high bending stiffness (causing a deflection smaller than 0.008° between interface flanges) adding the minimum mass possible to the system (less than 700kg). This is easily identified as the main design driver to be considered. The Prime Focus Rotator positions the Fibre Positioner to an accuracy of 5 arcsec when tracking and guides all the fibres and other power and control lines through a cable wrap, for which the available space is limited.

IDOM proposal to comply with these coupled requirements consists of an optimized structural system with a slightly preloaded cross roller bearing providing the highest possible stiffness to weight ratio. The rotation is driven by means of a direct drive motor powered by a servo drive. For the Cable Wrap, a compact design based on a concept previously developed by IDOM for the Folded Cassegrain Sets the GTC was proposed.

Keywords: WEAVE, telescope, William Herschel, Fibre Positioner, Prime Focus Rotator, spectroscopy, IAC

1. INTRODUCTION

The solution proposed by IDOM for the WHT Prime Focus Rotator System is based on the concept developed and successfully applied by IDOM in the Gran Telescopio Canarias (GTC) Folded Cassegrain Sets, composed each of an Instrument Rotator and the Acquisition and Guiding optomechanics. This concept provides a very compact solution in which accessibility to the different lines in the cable wrap is enhanced for maintenance.

This solution is based on two structures, stationary and rotating, connected by means of a cross roller bearing and driven by frameless direct drive motor. The services between the two rotating elements are transferred with a built-in double reverse bending radius (RBR) cable wrap which is supported by means of a two-flexible arrangement of rollers connected to each other. The possibility of disassembling the supporting system allows a very simple assembly and maintenance of the lines in the cable wrap.

This design maximizes the stiffness and minimizes the mass of the system by providing the most direct possible load path between the Central Can and the Fibre Positioner. For this to be possible a slight modification of the interfaces is requested to be considered.

The large structural parts are conceived taking advantage of the natural stiffness provided by cylindrical and conical shapes avoiding whenever possible the additional ribs. For the sake of dimensional stability and structural integrity welded pieces are avoided, most structural parts are proposed to be machined (typically on a vertical lathe and milling machine) from a single piece.

Elements which need a more frequent access both during the commissioning and the maintenance of the system (e.g. brake system, limit switches, end stops) are implemented on a convenient area in which access is the easiest.

2. FORMATTING OF MANUSCRIPT COMPONENTS

The design of the rotator proposed by IDOM is conceived to provide the highest stiffness and lowest weight. This solution is based on two structures, stationary and rotating, connected by means of a cross roller bearing and driven by frameless direct drive motor. The services between the two rotating elements are transferred with a built-in double reverse bending radius (RBR) cable wrap, which is supported by means of a two-flexible arrangement of rollers connected to each other. The possibility of disassembling the supporting system allows a very simple assembly and maintenance of the lines in the cable wrap.

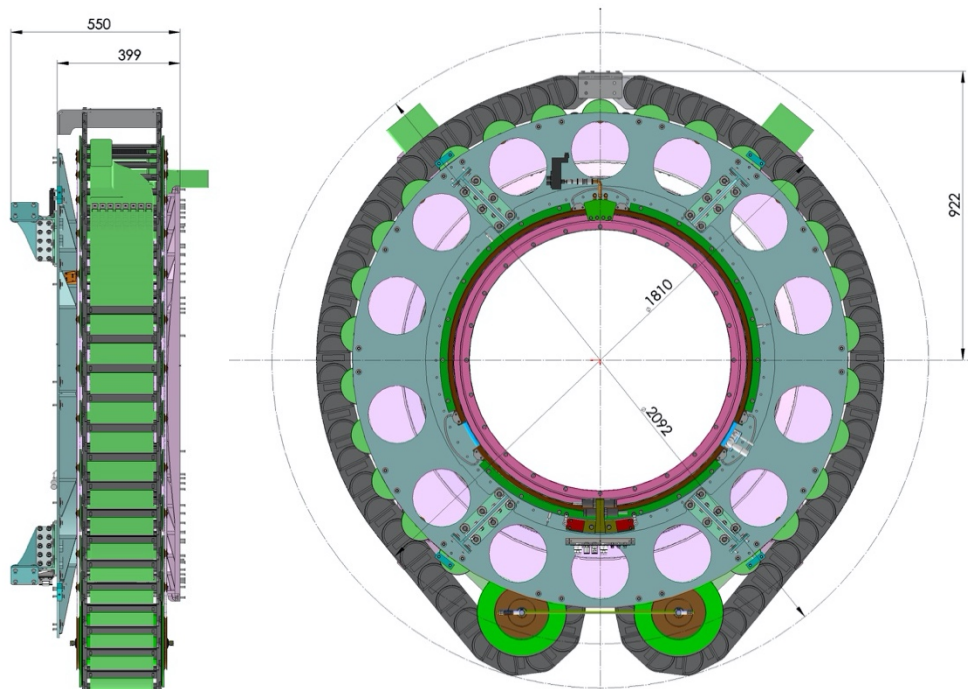

Figure 1. Main dimensions of the Prime Focus Rotator

The design development, which the inherent mechanical complexity of the Prime Focus Rotator and the additional complexity due to accessibility constraints and performance conditions, was conditioned by a series of Design Drivers:

- Objective Mass = 715kg, Final Mass = 762kg
- Design Volumes of adjacent elements
- Limits on the obscuration caused by the PFR
- Requirements on tilt stiffness of the assembly
- Great amount of cables and fibers to be transported by the cable wrap
- Motor procured by IAC
- Required tracking accuracy

The structural elements were intensively optimized, searching for the lightest solution without having negative local effects and compromising the stiffness of the assembly. This is a compact solution, in order to avoid the unnecessary use of material and achieve the most direct possible load path between the Central Can and the Fiber Positioner.

The interfaces with the Central Can was improved to reduce the tilt flexibility of the system and improve the load transmission between the PFR and the Central Can. To provide the desired connection while reducing the mass of the element four brackets were integrated between the Central Can and the PFR.

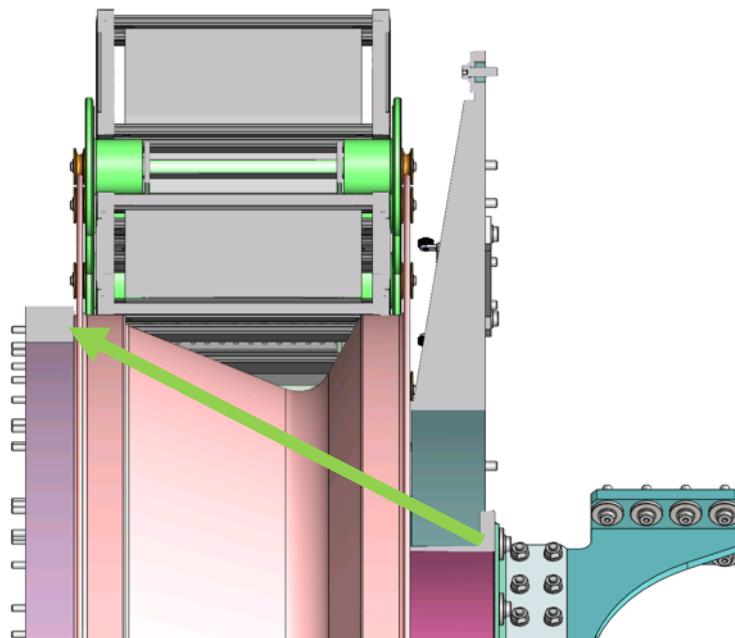
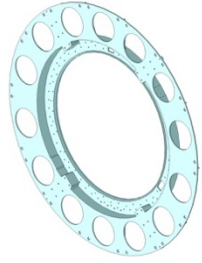
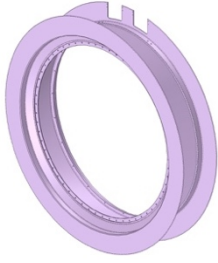
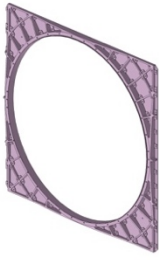





Figure 2. Scheme showing the load path

The main characteristics of IDOM's design are:

- **Large structural parts** that are conceived taking advantage of the natural stiffness provided by cylindrical and conical shapes avoiding whenever possible the additional ribs. For the sake of dimensional stability and structural integrity welded pieces are avoided, and a vast majority of the pieces are machined from a forged ring using a vertical lathe. The conical and cylindrical shapes allow to have an efficient Structural System while keeping the thickness of the pieces low and thus also the mass of the system. The fact that most of the pieces can be machined from a forged ring minimizes the internal stresses, ensures a greater dimensional stability and makes it easier to achieve greater precision.



Table 1. Information about the main structure components.

MAIN STATIC HUB	MAIN ROTATING HOUSING	ADAPTER
		
<p>It brings the loads from the Central Can to the static ring of the bearing. The Main Static Hub is connected to the Central Can by means of 28 M8 bolts on one side and to the static ring of the bearing by means of 60 M8 bolts.</p>	<p>Connects the moving ring of the bearing to the Adapter located between it and the Fiber Positioner.</p> <p>It is the main element of the load path but it also serves as the support of the Cable Wrap roller guides and of the moving part of the Cable Wrap.</p>	<p>Light-weighted Aluminium piece that was included between the Main Rotating Housing and the Fibre Positioner in order to ensure a stiff connection to the Fibre Positioner.</p>
DRIVE MOTOR SUPPORT	MAIN ROTATING HUB	ROTATING BRAKE FLANGE
		
<p>It supports the stator of the frameless motor and thus provide the stator with a frame. This stator is packaged by another ring called the Drive Motor Lid, which is bolted to the Drive Motor Support</p>	<p>It is the frame for the rotor of the frameless motor. This piece is connected to the Main Rotating Housing close to the interface with the Fibre Positioner and extends from there towards the rotor. As a result of that, it also provides the motor with some natural protection.</p>	<p>It packages the rotor of the motor from the other side and, apart from that, extends further towards the interface with the Central Can, including the braking disk and the damper actuators on its other end.</p>

- A **Cable Wrap** that needs to be able to accommodate all the required fibers and cables in a way that they do not get stuck inside. For that reason, multiple dividers in both directions and some margin in all the compartments was chosen in order to be able to guide the cables appropriately without having excessive friction and minimizing the risk of the cables getting stuck.

- An **ETEL frameless motor** by ETEL is located in the heart of the rotator, close to the bearing with its stator and rotor appropriately packed by the Drive Motor Support and the Main Rotating Hub, respectively. This ETEL TMB-0990-050 frameless motor is powered by means of an AB-Rockwell Kinetix 5700 dual axis inverter. This motor is already equipped with temperature sensors and also includes a set of Hall-effect sensors. The motor is able to comfortably give the required 443 Nm of nominal torque and 531 Nm of peak torque.
- **Commercial elements**, that compact pneumatic brakes, four Telemecanic limit switches and two end-stops equipped with shock absorbers by ACE as safety devices. All these elements are located close to the Central Can interface, next to the bearing.

Table 2. Commercial elements.

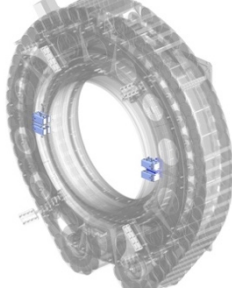
POSITION SWITCHES	SHOCK ABSORBERS	BRAKE SYSTEM
		
<p>The proposed limit switches to delimit the end of the travel are two adjustable Telemecanic XCMD 22mm Compact Metal Safety Position Switches. According to the limits strategy defined by the Project Team, while the operational range is defined between -160° and $+160^\circ$, the limit switches are located at -161° and $+161^\circ$.</p>	<p>The end-stop dampers is an ACE-MC600EUMH3 model, which has a stroke of 25.4mm. Taking into account its radial position, the angular stroke of the dampers is of approximately 3°. This way, the $\pm 172^\circ$ range of the cable wraps is enough for all possible scenarios, leaving the 5° margin.</p>	<p>4 brakes integrated to perform an emergency stop in less than 0.6 s. Breaks are commercial Ringspann DH 010 FPM – 012 M – 12 caliper fail-safe-type (normally closed) brakes, spring applied and pneumatically released. Selected due to their compactness.</p>

The integrity of the PFR was also ensured by means of different analyses performed with FE models that include Modal Analyses, Static Analyses for the Operational Loads with the aim of obtaining the operational deflections and Quasi-Static Analyses for the Survival Loads, from which the maximum stresses and loads on the bolted joints were obtained.

The survivability of the bolted joints, was also verified by an analytical calculation for each of them with the aim of showing that the bolt selection is adequate and that the bolted joints will not slip. The main bolted connections, located in the load path, were included in the FE models simulating the preload in the point for more accurate results. Other Analytical calculations, presented together with the Joint Calculations, include a Fabrication Tolerance Analysis, a Brake Analysis and a Damper Analysis.

In addition, a series of Engineering Budgets were deemed adequate: a) Error Budget has allowed to verify the tracking requirement; b) Torque Budget has proved that the selected motor can achieve the required speeds and accelerations; c) Heat Generation Budget has estimated the heat dissipated by motor; d) RAM Analysis that checks the availability, reliability and maintainability requirements of the system.

The following table, shows a summary of the capacities that the PFR has:

Table 3. Requirements verification summary.

Description	Analysis Type	Obtained Value	Required Value
Maximum Speed	Torque Budget	1°/s	> 5°/s
Maximum Accel.	Torque Budget	1°/s ²	1°/s ²
Max. Tracking Speed	Torque Budget	1°/s	1°/s
Max. Tracking Accel.	Torque Budget	1°/s ²	0,3°/s ²
Tracking Accuracy	Error Budget	2.59 arcsec	> 5 arcsec
Braking Time	Brake Analysis	0.6s	< 1s
Heat Dissipation	Heat Gen. Budget	122.5 W	< 150 W
Max. Op. Flexure	Static FE Analysis	0.0062°	< 0.008°
Radial Runout	Fabr. Tol. Analysis	0.309mm	< 0.31mm
Axial Runout	Fabr. Tol. Analysis	0.045mm	< 0.05mm
Parallelism IF Flanges	Fabr. Tol. Analysis	0.00285°	< 0.005°
First Nat. Frequency	Modal FE Analysis	406 Hz	30 Hz
Transport Htal Loads	Quasi-static FE An.	5.14	DF > 1
Transport Vert Loads	Quasi-static FE An.	1.38	DF > 1
Seismic Loads	Quasi-static FE An.	1.12	DF > 1
Operational MTBF	RAM Analysis	38766 h	>10000 h
Lifetime	RAM Analysis	10 years	10 years
Availability	RAM Analysis	99.9880%	>99%

Moreover, finite element calculation was performed to validate the design of the interface with the Fibre Positioner and to ensure that the whole system has an adequate performance including a flexible Fibre Positioner. The modes and frequencies, stresses and deformations of the new design including the Fibre Positioner were compared with those of the PDC design, resulting in a very important improvement of the design.

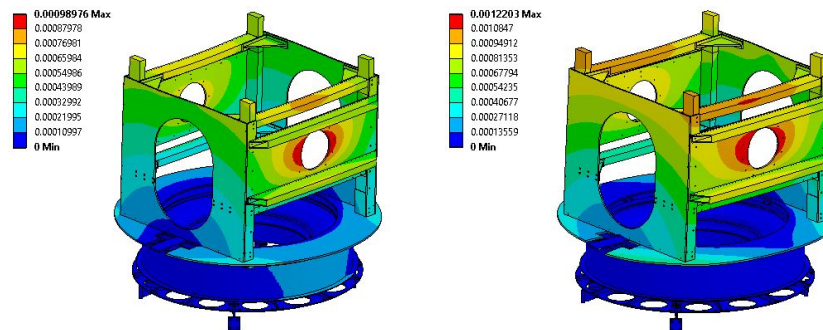

Figure 6. Static Deflections improvement by the use of the adapter, left hand-side model with the adapter, right hand-side model without the adapter

3. CONTROL SYSTEM

The PFR Control System comprises the Hardware and the Software necessary to rotate the PFR Mechanical Rotator Unit in a controlled manner. This Control System is divided into three layers:

1. Client Layer

This layer is out of scope of this project. It provides interfaces for the telescope personnel or external, upper-level systems to command the PFR system. This layer includes all actors listed in the previous sections: TCS, ACS, MCP, LCP and Engineering GUI.

2. Control Layer

This layer includes all low-level control elements, such as drives, PLCs (control units) and I/O blocks. It accepts commands from the clients and actuate the hardware properly. It also collects all signals from the sensors and provides them to the clients.

3. Field Elements Layer

This layer includes all actuators (motor, valves, etc.) and sensors (temperature sensors, limit switches, etc.) that are in the system.

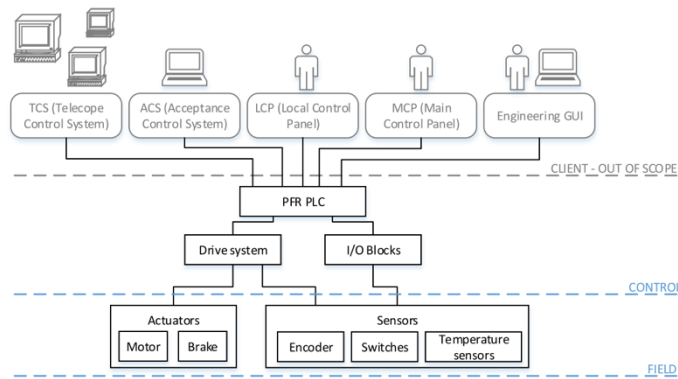

Figure 7. General architecture of the control system

The context diagram for the PFR control is composed with external actors and entities that interact with it, as shown in the diagram.

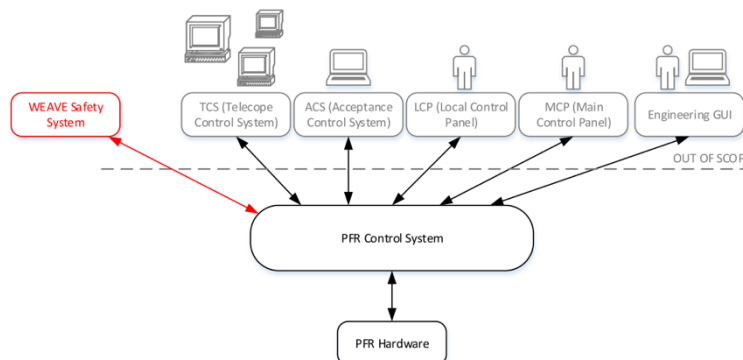

Figure 8. Context diagram

The PFR Control System accepts commands from the following actors:

- **TCS:** Telescope Control System: High Level Software. The TCS commands through a bridge computer, via CIP (Common Industrial Protocol) and PLCIO (communication library), during final integration and operational phases.

- **ACS:** Acceptance Control System: Supplied by IAC or WEAVE, is used for the development and verification phases. It emulates TCS behavior.
- **LCP:** Local Control Panel, used for manual movement of the prime focus rotator; it shows the rotator position, display information about interlocks, alarms and limits, the motor current and the operational mode; it also has an acknowledge button for silencing the alarms. LCP communicates with the PFR using a set of tags.
- **MCP:** Main Control Panel, situated in the control room; it consists of a touch-sensitive display and a number of physical buttons, including the emergency stop buttons and a key for switching between the manual and computer control. MCP communicates with the PFR using a set of tags.
- **Engineering GUI:** (also called Engineering Consoles along the document) to provide an independent and complete access to the instrument mechanisms using a different path than the one used by the standard command interface of the observing system; it provides an interface with the same look and feel of other instruments at ING, and not requiring any previous knowledge about the command syntaxes.
- **WEAVE Safety System:** PFR control system exchanges interlock signals with WEAVE safety system.

The PFR control system is defined by four modes and five states (see figure below). The initial state is Off, when the PFR is powered down. To operate, the system must be initialized (Initializing) – when all the systems are ready to operate and motor is powered off and retained in a fixed position, system remains in state Standby. During movement, system can be in Slewing state (moving to a specific position) or Tracking state (following the commands stream).

In Engineering mode, any demands from the bridge computer must be ignored without causing an alarm. Only manual control is allowed. In Override mode the same conditions apply, but interlocks can be overridden. In Computer mode only demands from the bridge computer are accepted and system performs a speed loop. In Test mode, the motion controller takes the control and is able of running several test programs.

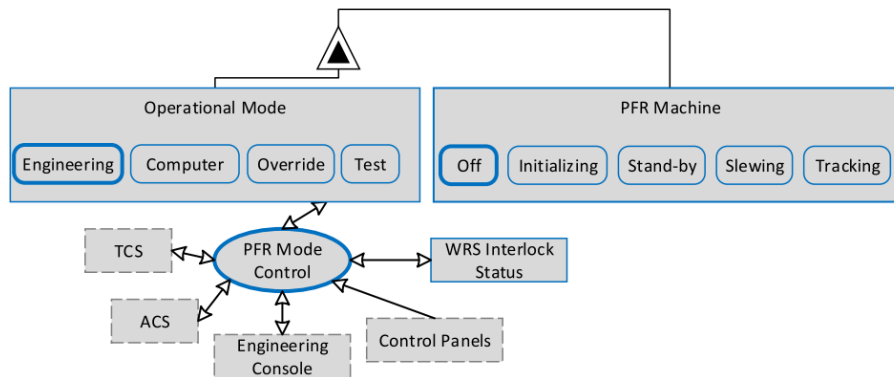

Figure 9. Modes and states of the control system

The whole hardware architecture of the PFR control system is presented in the following diagram. It presents the hardware in scope of this project, as well as hardware out of scope, connected to the PFR system.

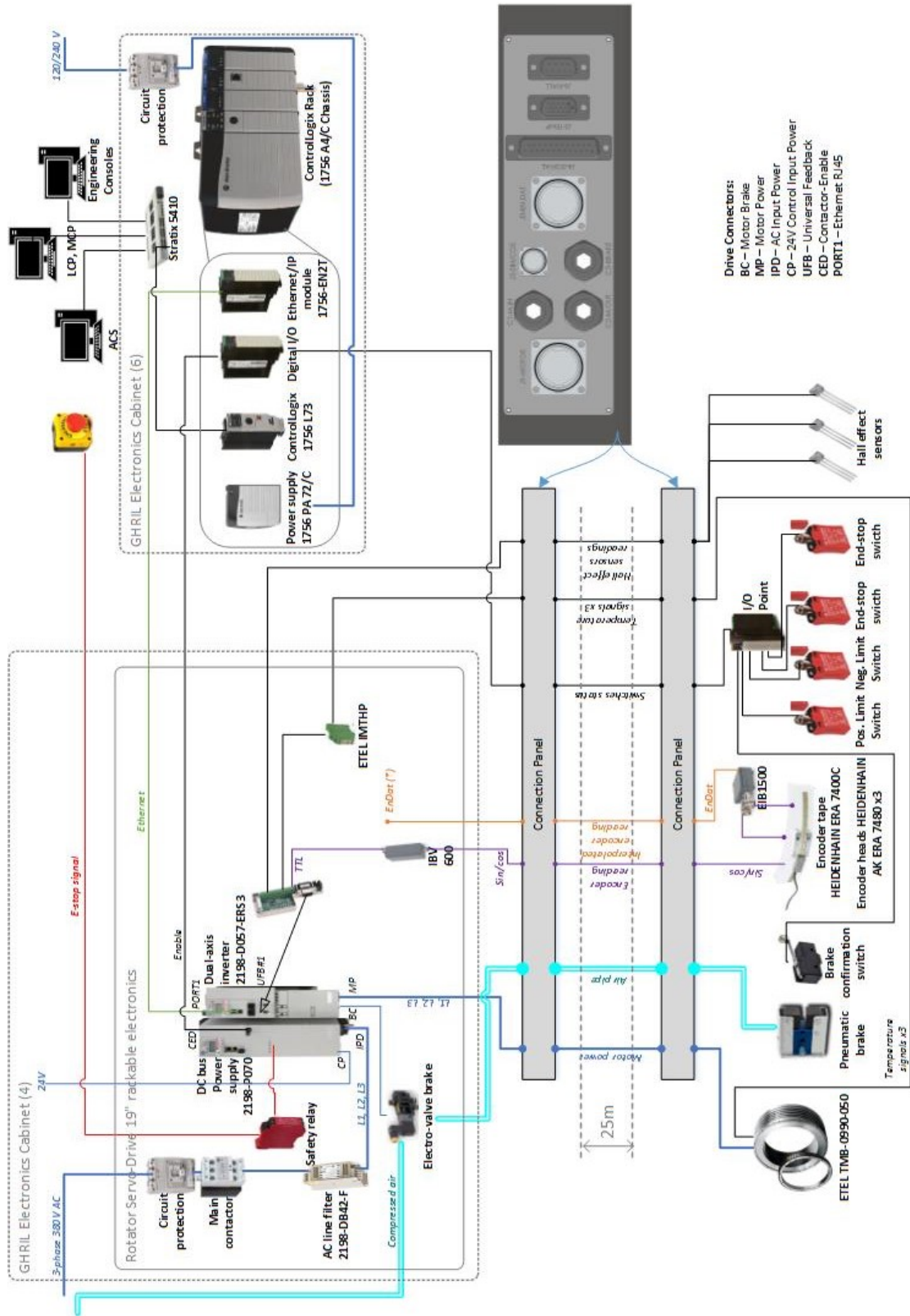

Figure 10. Control hardware architecture

4. MANUFACTURING AND PROCUREMENT

The manufacturing of the mechanical parts was performed in Talleres Aratz, Vitoria-Gasteiz, Spain. The use of industrial-like fabrication techniques, such as sand-mould casting, CNC machining and laser tracker measuring for dimensional verifications, that ensures the required performances for multi-object spectroscopy observation. The following figure shows the manufacturing techniques applied to the fabrication of Main Static Hub, Drive Motor Support & Adapter to the test bench.



Figure 11. a) Casting die, b) mould and c) machining operation for the design

Big forged structures were machined to provide accurate interfaces for sub-assemblies, such as the Main Rotating Hub (right) or Main Rotating Housing (left), among others.



Figure 12. Machined & Polished components

An exhaustive quality control was followed during this phase to ensure the final performance of the rotator.

5. ASSEMBLY, INTEGRATION AND VERIFICATION

The assembly and integration of the system was carried out in two different phases:

- Prior to commence with painting works, the mechanical components are preassembled in Talleres Aratz for intermediate inspections. The aim is to check all the critical tolerances and the fitting between components. Every component is disassembled and send to cleaning & painting works.



Figure 13. PFR mechanical re-assembly

- The second stage of assembly though, is carried out in IDOM's laboratory, in a clean and controlled environment. The cleanliness is controlled under severe procedures, so all the quality requirements can be guaranteed. During this final assembly, all the commercial elements & cabling routings are going to be also integrated.

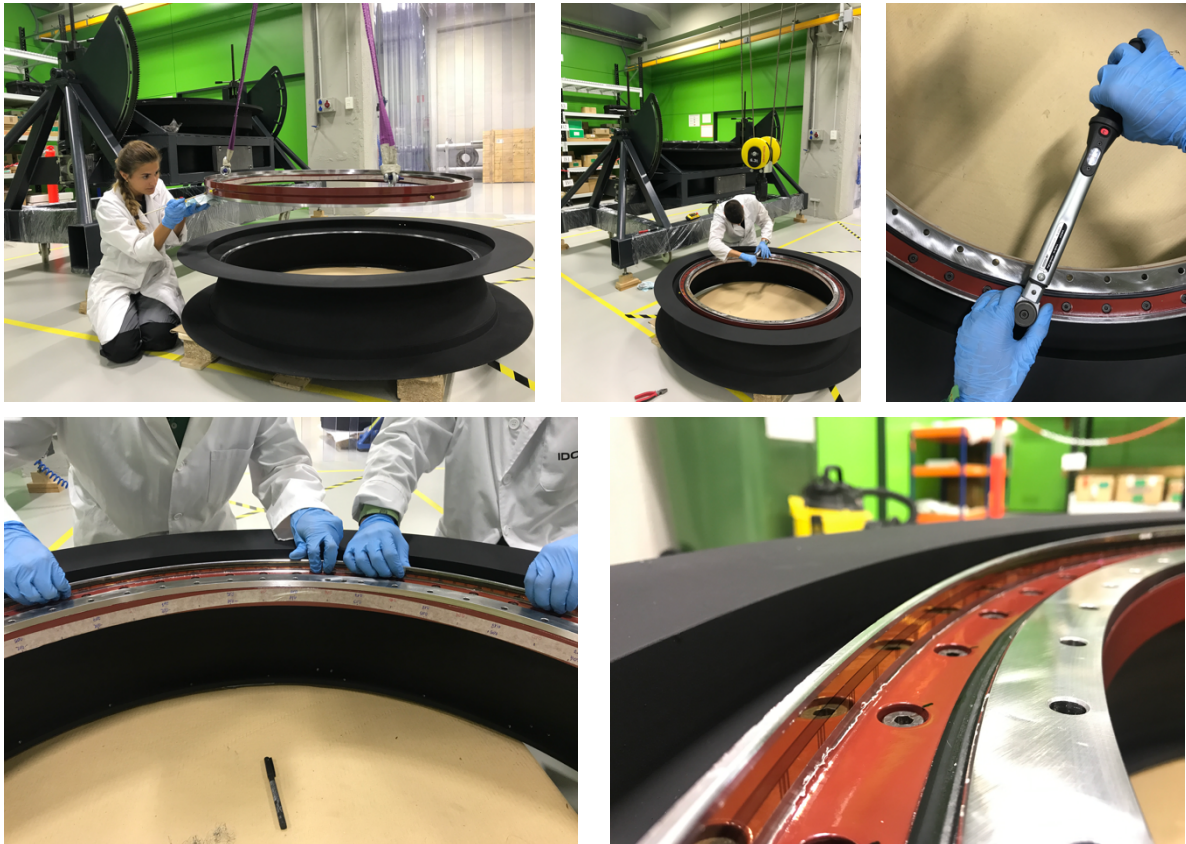
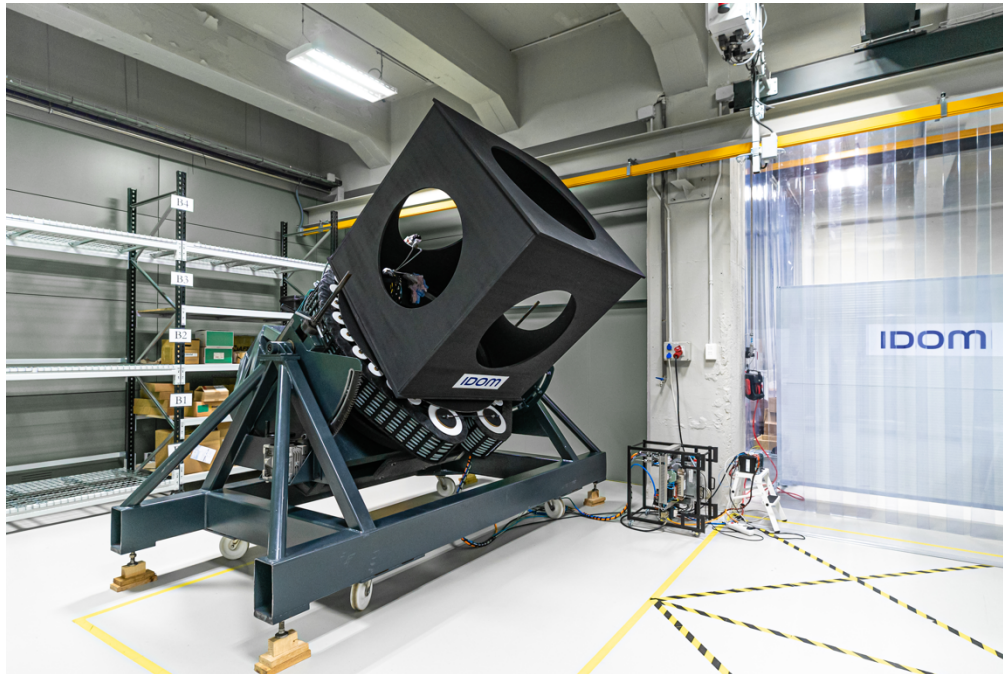

Figure 14. a) Bearing assembly, b) Encoder tape assembly on the bearing

After the assembly works are completed, the integration of the Control System and the mechanical parts were done, configuring the frameless motor's & electro-valve's control loops, setting the electrical end switched reactions or hall sensor installation among others.

After the commissioning of the rotator, the Factory Acceptance Tests were performed to get the performance acceptance.



6. CONCLUSIONS

With the Prime Focus Rotator design, IDOM was able to present an innovative solution, with which the highest stiffness and lowest weight structure was achieved. These structural elements were intensively optimized with the aim to comply with the mass limit or fit with the adjacent elements among other restrictive design drivers.

Thanks to the rotator system, which is interfacing the fiber positioner with the central can that contains the prime focus corrector optics and electrical will be supplied from the static to rotatory elements.

ACKNOWLEDGMENTS

- [1] Spanish Economy, Industry and Competitiveness Ministry through FEDER funds of the Intelligent Development operative program.