

# Influence of the elongation of solid polymer electrolyte on the ionic conductivity

R. Jeanne-Brou\*, G. de Moor, N. Charvin, J. Deseure, L. Flandin, R. Bouchet, and D. Devaux \*

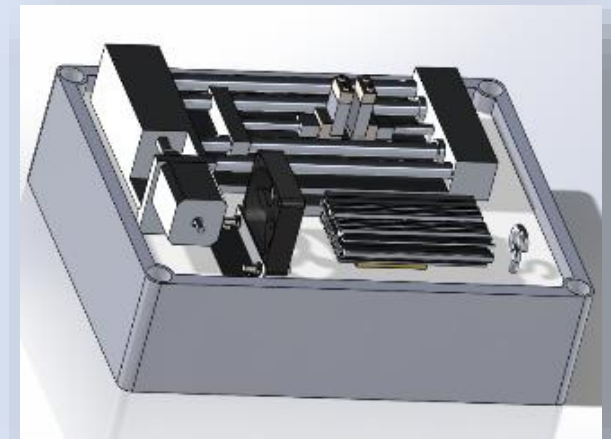

\* Univ. Grenoble Alpes, Univ. Savoie Mont Blanc, CNRS,  
Grenoble INP, LEPMI, 38000 Grenoble, France

Date: January 27, 2021

## 1- Introduction

- State of the art: Ionic conductivity in solid polymer electrolytes  
Mechanisms & anisotropy of conduction

## 2- Transport Ionic

- Methodology
- Ionic conductivity  $\sigma$  (S.cm<sup>-1</sup>)
  - Electrochemical impedance spectroscopy

## 3- Mechanical test: elongation of membrane

- Home made setup “*tensile-box*”
- Influence on the ionic conductivity

- Context**

Need to develop high energy density and safe batteries [1]

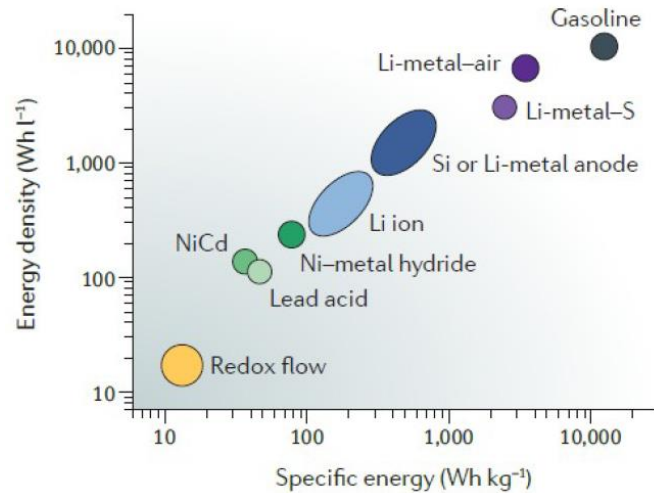

- Perspective**

Battery with negative electrode compatible with Li metal



- Issue**

Li metal with conventional liquid electrolytes

- Short-circuit hazard: flammable electrolyte and dendritic growth [1]

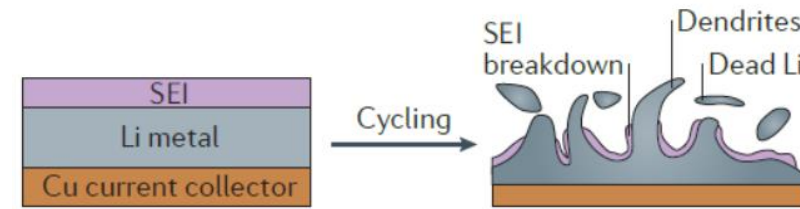

- Solution**

Replace liquid electrolytes with Solid Polymer Electrolytes (SPE)

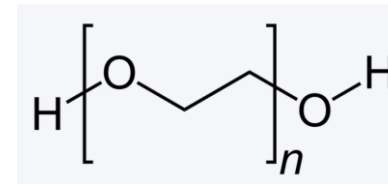

e.g. PEO :  
Poly(ethylene oxide)

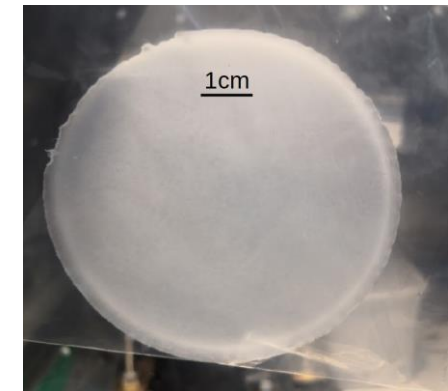

[1] : J.Lopez *et al.*, *Nature Reviews Materials* volume 4, 312–330 (2019)

## ■ Addition of nanocharges

For example: Cellulose [1]

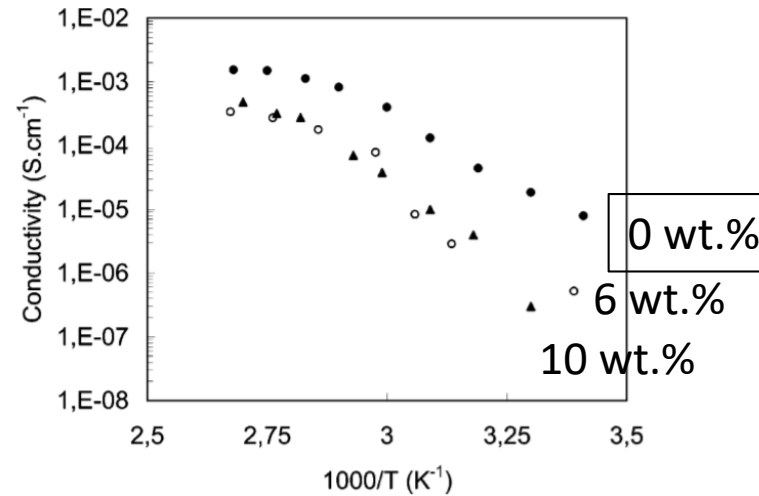
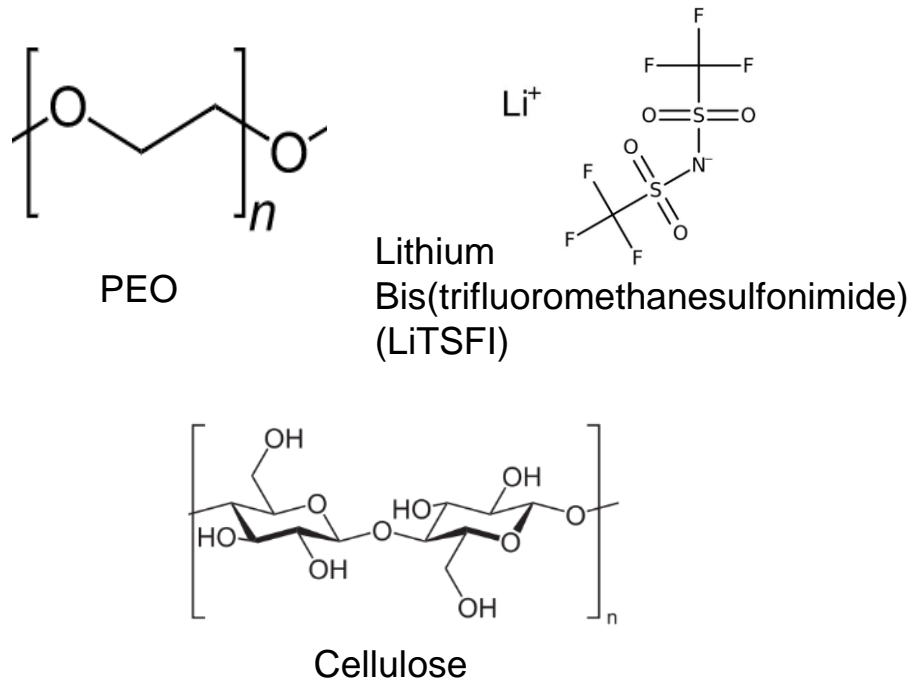

- Nanocharge wt.% increase  
 $\sigma$  (S.cm<sup>-1</sup>) decrease

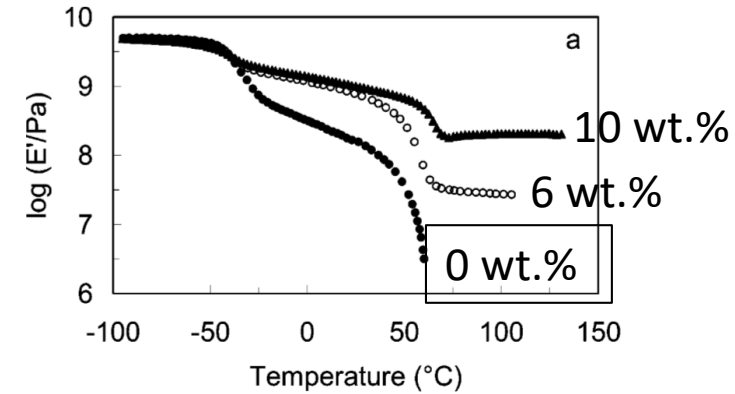

- Nanocharge wt.% increase  
Storage tensile modulus E' increase

➤ Main optimum:  
~ 2 × 10<sup>-4</sup> S.cm<sup>-1</sup> at 90°C with 6 wt.% of nanocharges

[1] : M.S. Azizi *et al.* *J. Phys. Chem. B* 2004, 108, 10845-10852

- Addition of nanocharges

For example: Cellulose [1]

- Cross-linked polymer [2]

- Synthesis of block copolymers

For instance: PS-PEO (Poly(styrene)-PEO ) [3]

- Single-ion copolymer [4]

## Single-ion conductor triblock

P(STFSILi)-b-PEO-b-P(STFSILi) [4]

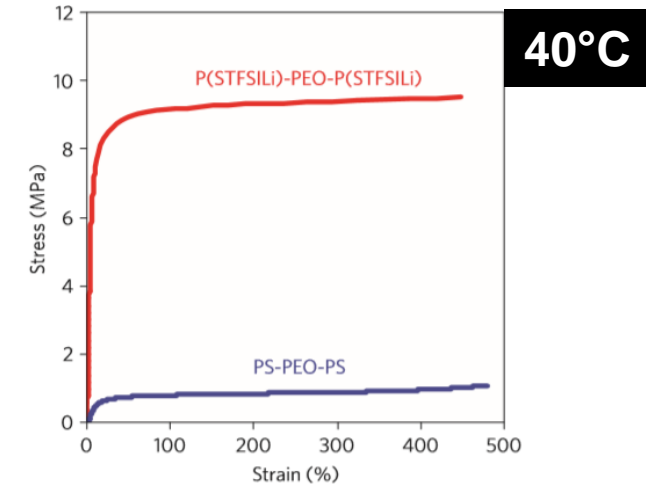
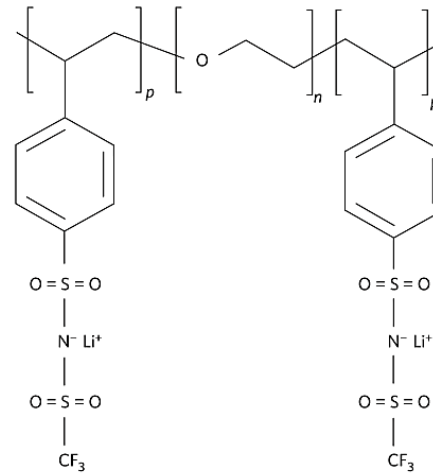

### Main result:

- $1.3 \times 10^{-5}$  S/cm at 60°C and  $t^+ > 0,92$

Great interest against the dendrite growth and the limited power delivery [4]

[1] : M.S. Azizi *et al.* *J. Phys. Chem. B* 2004, 108, 10845-10852

[2] : H. B. Youcef *et al.* *Electrochimica Acta* 220 (2016) 587-594

[3] : D. Devaux *et al.* *Chem. Mater.* 2015, 27, 13, 4682-4692

[4] : R. Bouchet *et al.* *Nat. Mat.*, 1-6, 487 (2012)

- Different mechanisms in the **amorphous** and **crystallized** phases (ordered phase) [1]

- Polymer chains motion / Hop of  $\text{Li}^+$

- **Oriented polymer materials**

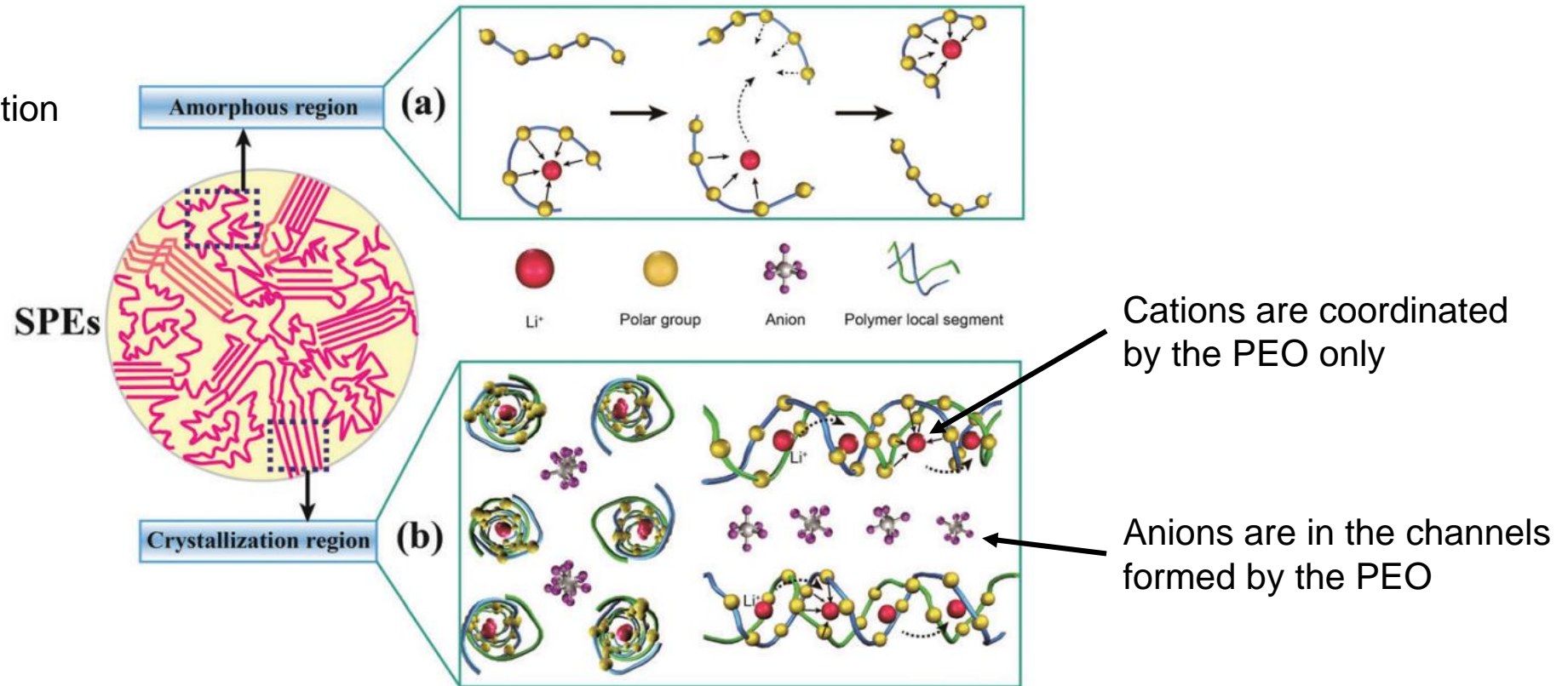

[1] : R. Chen *et al. Mater. Horiz.*, 3, 487 (2016)

- PEM nanostructure <sup>[1]</sup> PS-PMB with PS & PMB (2.5 et 2.6 kg.mol<sup>-1</sup>)

**Method**

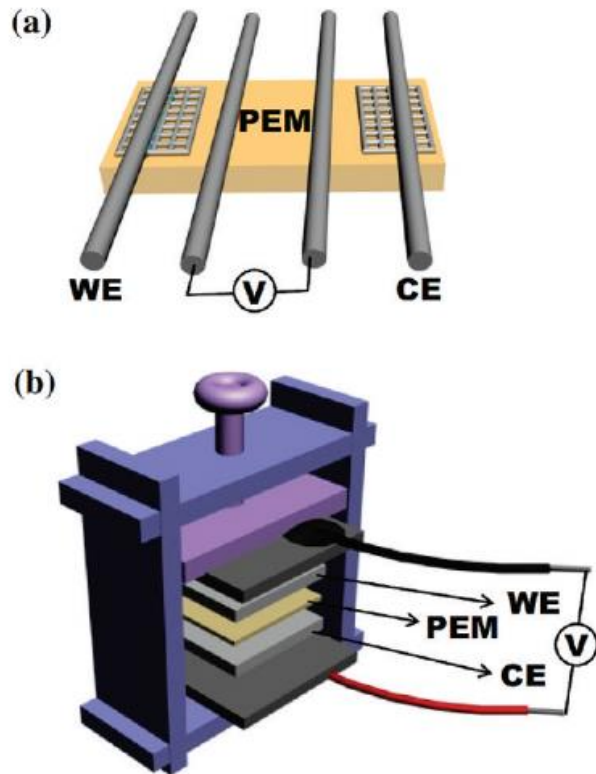

**Nanostructures and alignments**

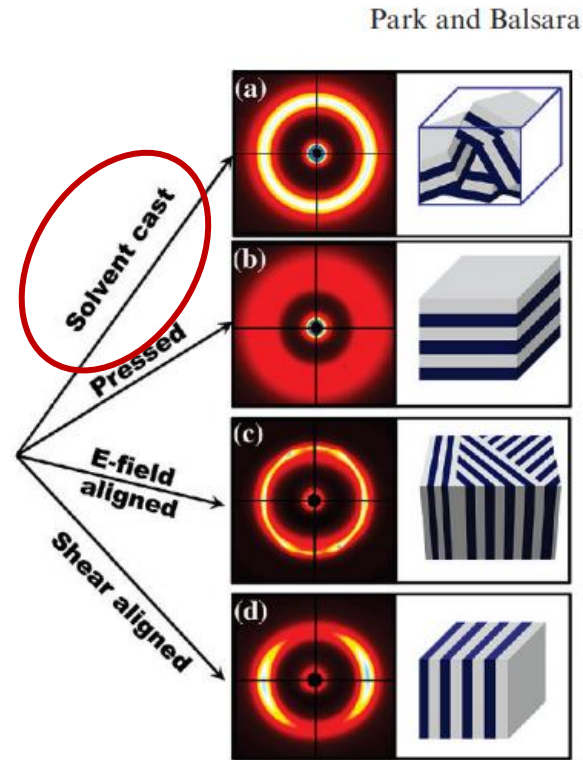

**Results**

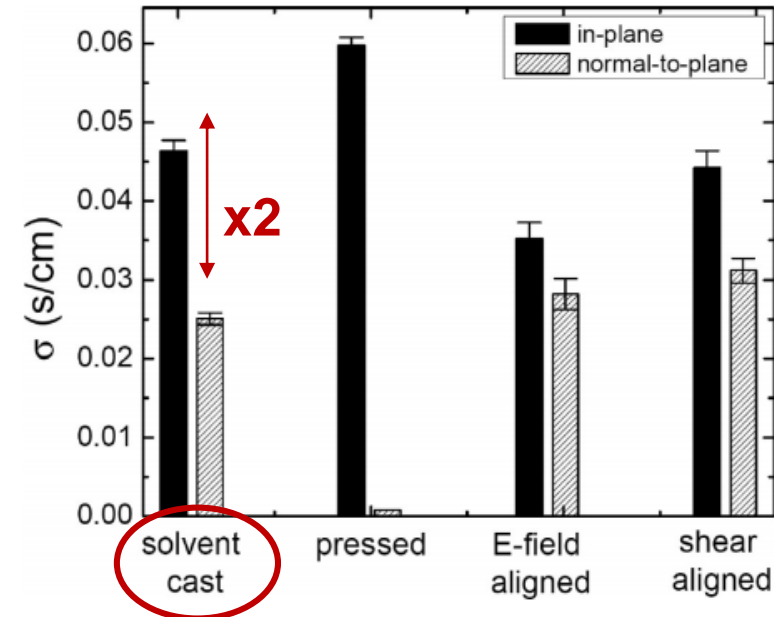
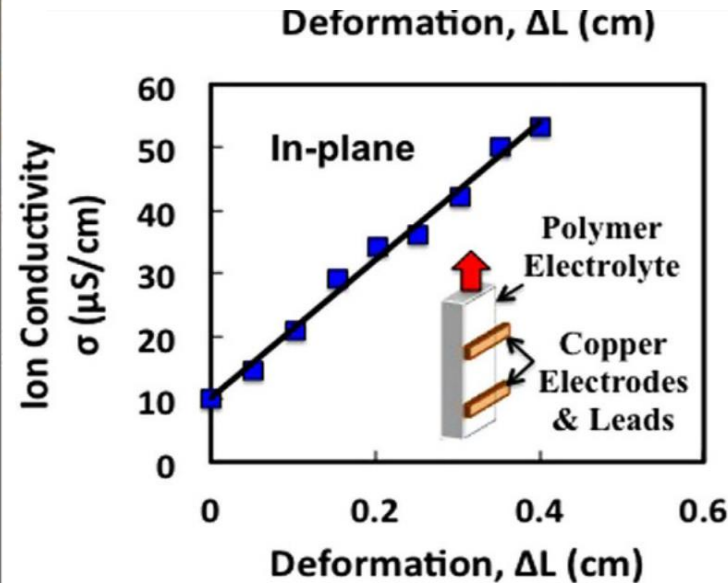
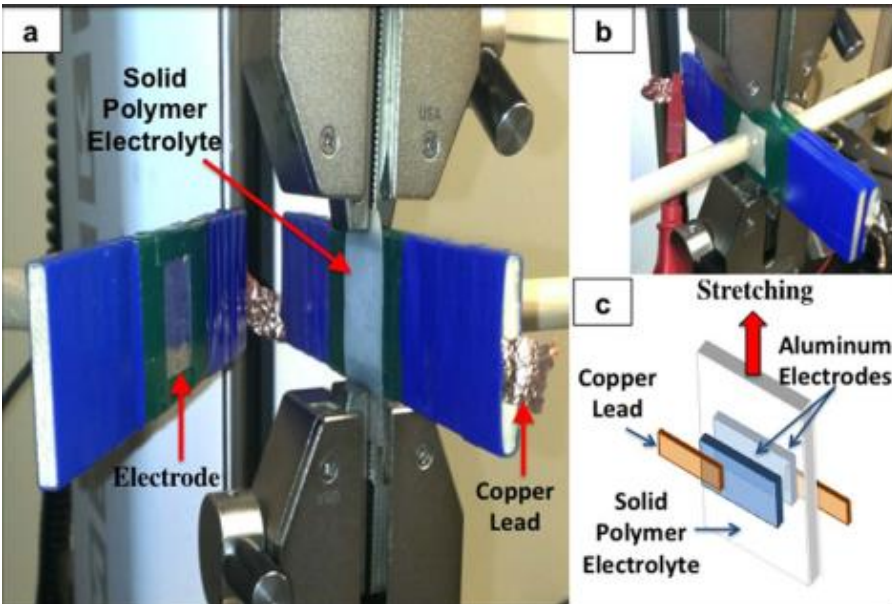

Figure 7. The equilibrium in-plane and normal-to-plane conductivity values of as-cast and aligned samples.

[1] : Moon Jeong Park and Nitash P. Balsara. *Macromolecules*, Vol. 43, No. 1, 2010

▪ Elongation of membrane [1-2]



- Air → Humidity : electrical and morphological properties are modified
- At room temperature

➤ What happen when  $T > T_{\text{melting point}}$ ?

Material PEO (6 000 kg/mol) ; Salt :  $\text{LiClO}_4$  OE/Li ~ 16

Main result at  $\Delta L = 0.3$  cm

- $1 \cdot 10^{-5} \text{ S}\cdot\text{cm}^{-1} \rightarrow 4 \cdot 10^{-5} \text{ S}\cdot\text{cm}^{-1}$

➤ **+1/2 decade on  $\sigma$  at 25°C**

[1] : S. H. Chung, *et al. Electrochem. Solid-State Lett.*, 2, 553 (1999)

[2] : T. Kelly *et al. Scientific reports Nature*, 6, 20128 (2016)



▪ **Process of elaboration**



- Electrolyte: Polymer + lithium salt
- Solvent: dimethylformamide (DMF)
- Evaporation: room temperature & 60°C
- Membrane storage: dry glove-box (no solvent)

▪ **Cell types & Impedance spectroscopy method**

*In-Plane configuration*  $\sigma_{\perp}$       *Through-Plane configuration*  $\sigma_{//}$

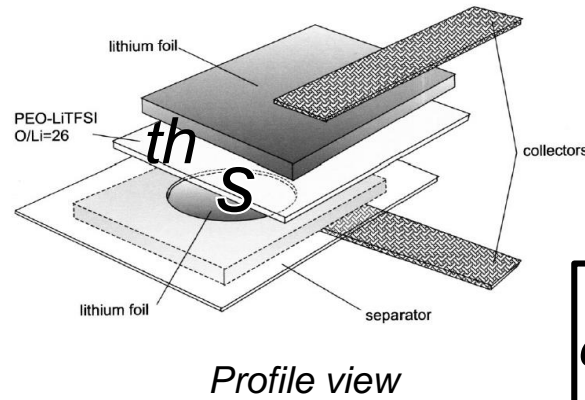

$$\sigma = \frac{k}{R_{el}}$$

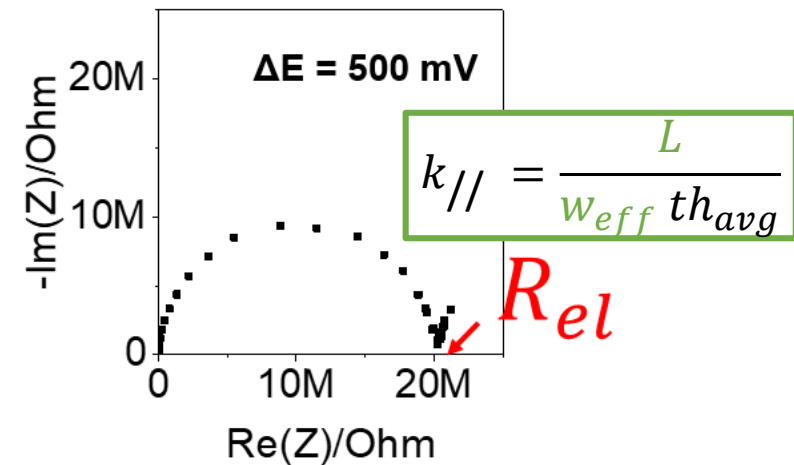
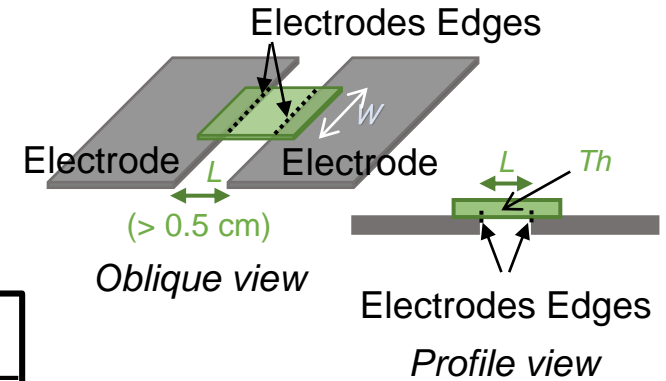
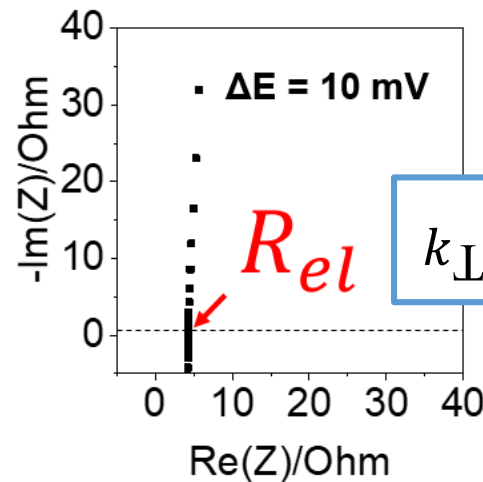

## Method

Stationary electric current in conductive medium under COMSOL MULTIPHYSICS®

→ Ohm's law  $J = \sigma E$   
with  $J$  current density (A/m<sup>2</sup>).

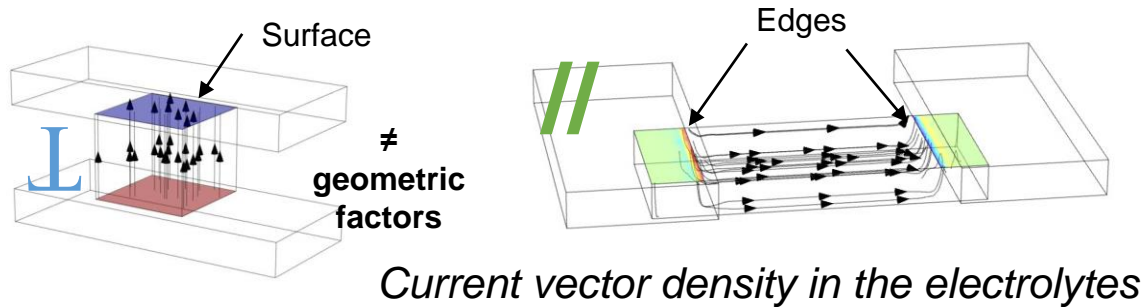

## Results

Case of a PEO/LiTFSI membrane

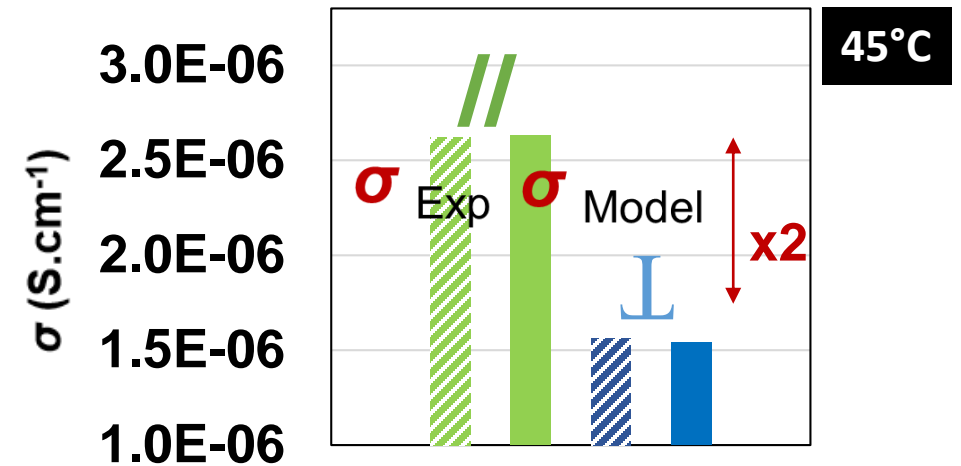

- $\sigma_{Exp}$  and  $\sigma_{Model}$  are identical
  - Edge effect in the cells is negligible
- **Methodology is valid**

### Input

U applied (V)  
Geometry of the measure  
 $\sigma$  Experimental

### Output

Current density of the electrolyte (A/cm<sup>2</sup>)

Cross section surface of the SPE (cm<sup>2</sup>) =  $l$

$I / U = R_{el}$  in modeling

→  $\sigma$  Model

$R_{el}$  in experiment ↔  $R_{el}$  in modeling →  $\sigma_{Exp}$  vs.  $\sigma_{Model}$

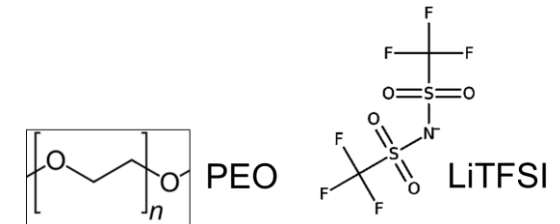

### ■ Ionic conductivity measurements

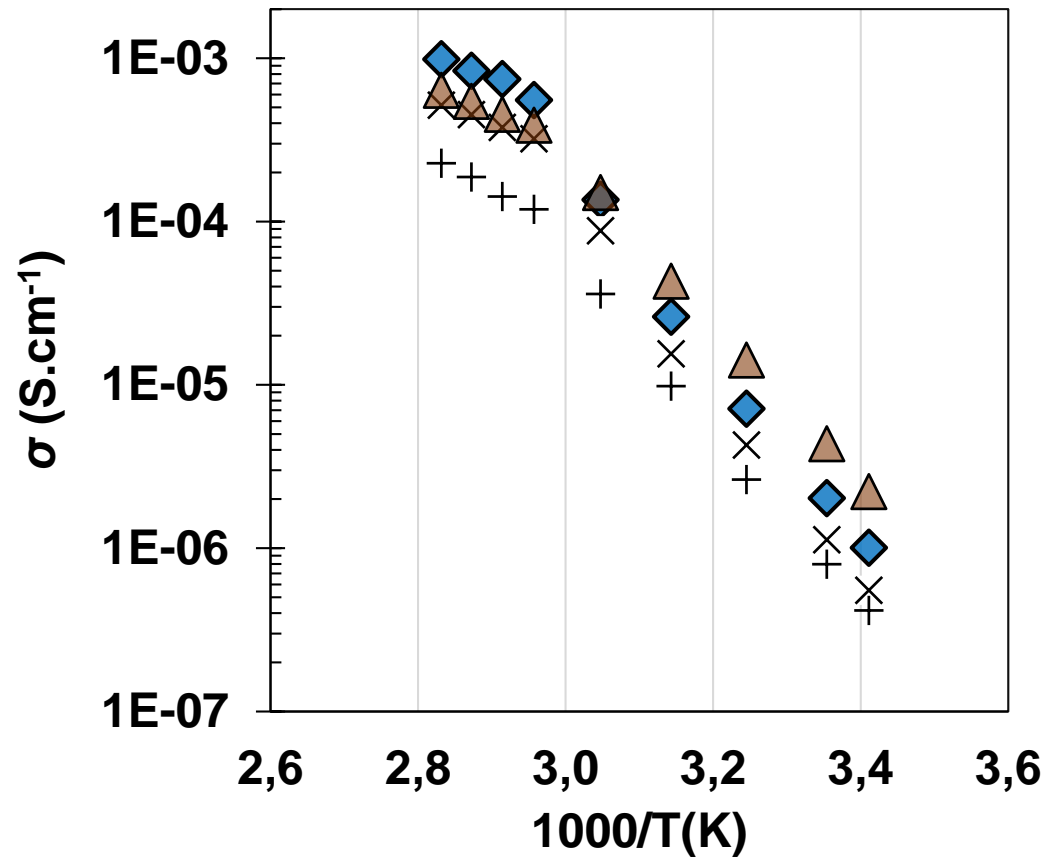

◆ // PEO

× ⊥ PEO

▲ // +NCC

+ ⊥ +NCC

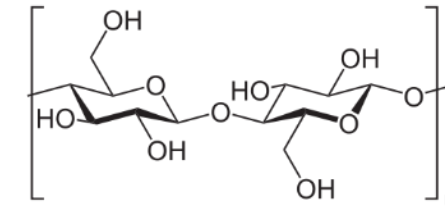
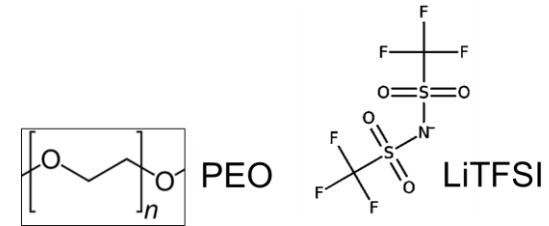

Nanocharges of cellulose NCC

At 70°C	// PEO	⊥ PEO	// +NCC wt.10%	⊥ +NCC wt.10%
$\sigma$ (S.cm <sup>-1</sup> )	$7,5 \cdot 10^{-4}$	$3,8 \cdot 10^{-4}$	$4,5 \cdot 10^{-4}$	$1,4 \cdot 10^{-4}$
$\sigma_{//} / \sigma_{\perp}$	1,98 ~ 2		3,17 ~ 3	

- $\sigma_{//} > \sigma_{\perp}$  for PEO LiTFSI and with NCC
- Can be linked at the study of free volume theory (VTF model,  $E_a$ ), calculations are ongoing

▪ Home made setup

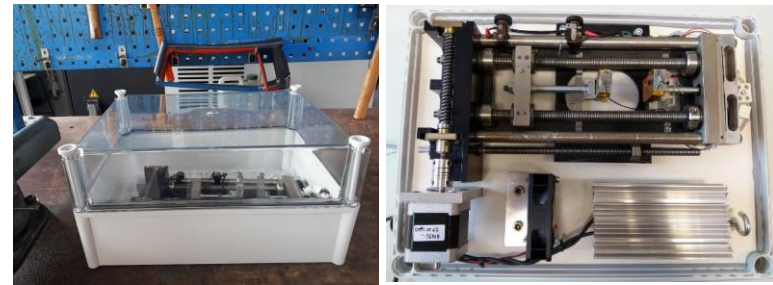

« Tensile box »

▪ Ionic conductivity measurement

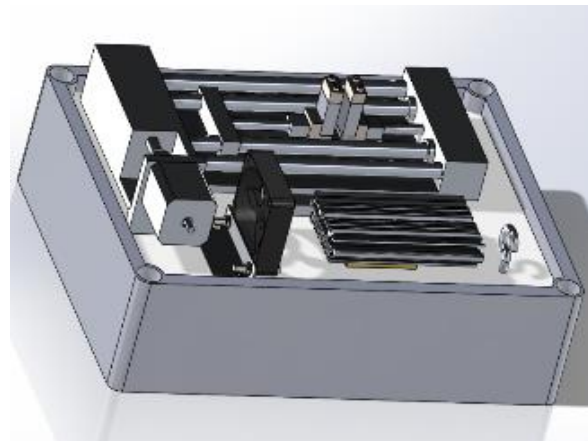
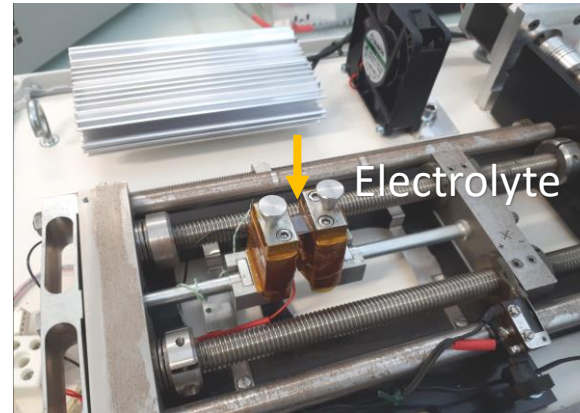

Schedule on SolidWorks

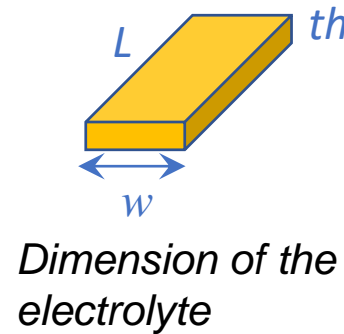
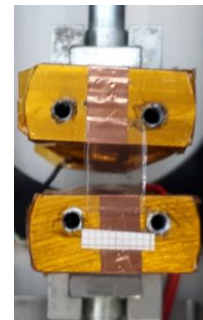

▪ Results

Copolymer PEO-PPO

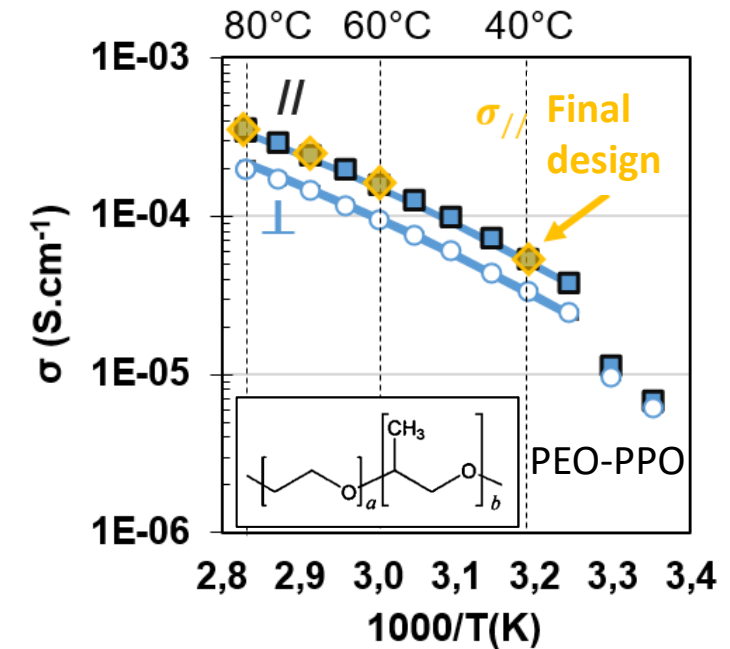

•  $\sigma_{//}$  pouch cell = tensile box

➤ Sample environment is under temperature controlled & in dry condition

**Assembly is working**

## Instrumentation

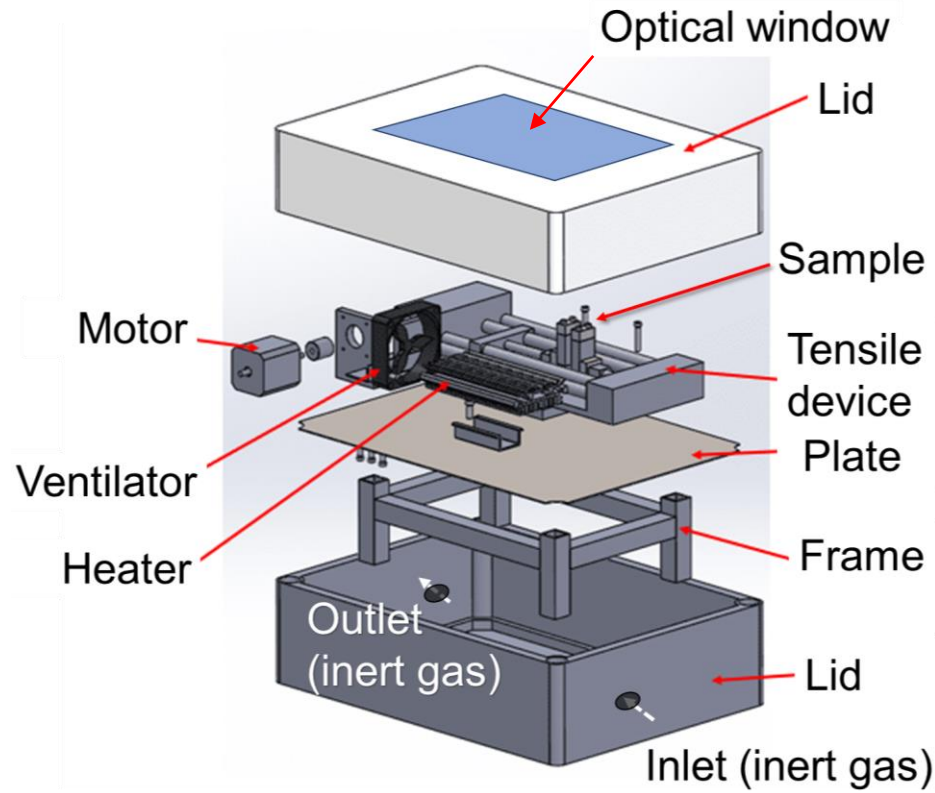

**Final design** – with versatile T

## Method

### Through-plane //

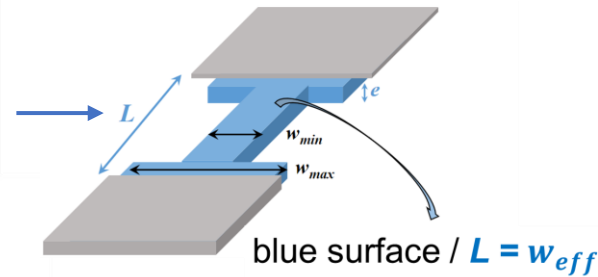

$$\sigma = \frac{k}{R_{el}}$$

$$k_{//} = \frac{L}{w_{eff} th_{avg}}$$

## Results

### $\sigma_{//}$ upon stretching

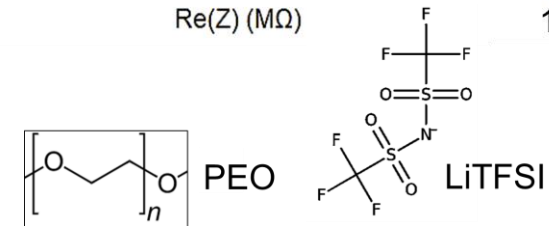
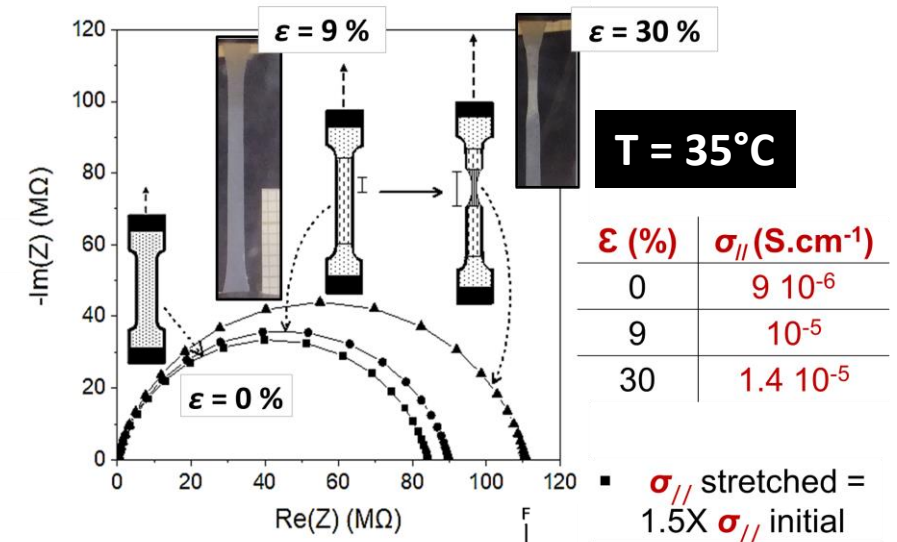

➤ **When  $T < T_{melting}$**   
 $\sigma_{//}$  stretched for PEO LiTFSI is higher than  $\sigma_{//}$  initial

## Instrumentation

Design of a setup to couple:

- Electric measurements
- Elongation as a function of temperature and under inert gas

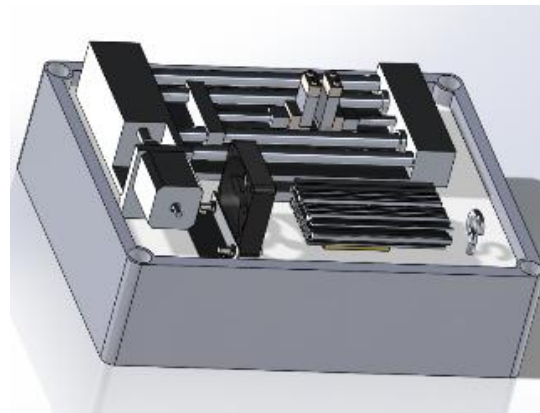

Schedule on SolidWorks

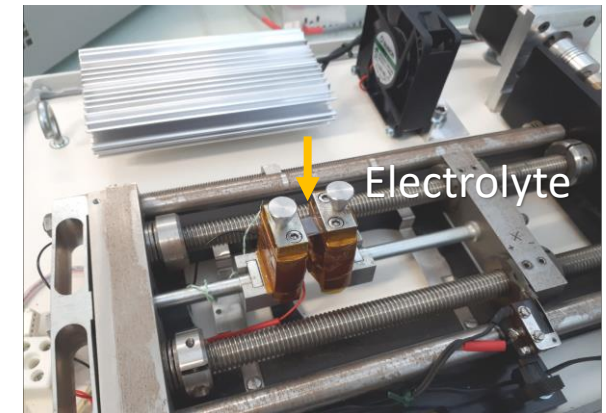

Real instrument

## Electrochemistry measurement

- $\sigma_{//} > \sigma_{\perp}$  for all PEO based SPEs (homopolymer, composite, statistical)
- Modeling captures the experimental behavior

## Perspectives

Electrochemistry: Evaluate the other transport properties

Material characterizations for the anisotropy: SAXS and/or Infra red and Raman measurements

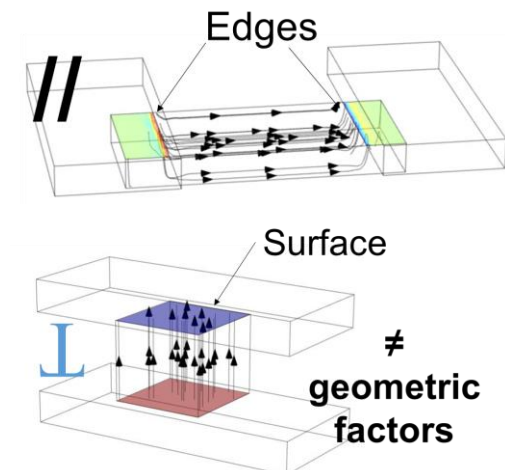
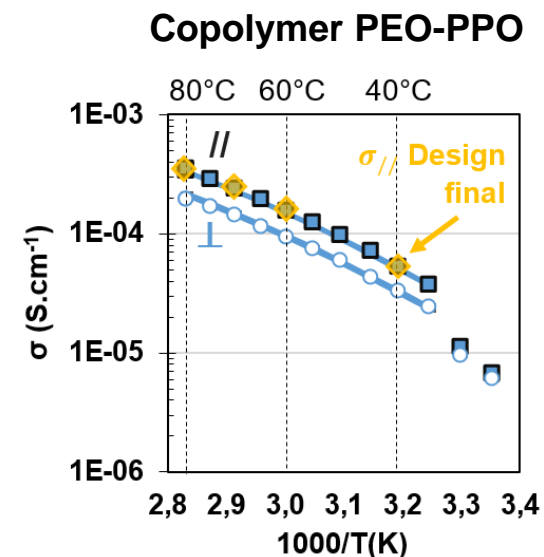



financé par  
IDEX Université Grenoble Alpes



R. Jeanne-Brou \*, G. de Moor, N. Charvin, J. Deseure,  
L. Flandin, R. Bouchet, and D. Devaux \*

[roselyne.jeanne-brou@grenoble-inp.fr](mailto:roselyne.jeanne-brou@grenoble-inp.fr)

[didier.devault@grenoble-inp.fr](mailto:didier.devault@grenoble-inp.fr)

\* Univ. Grenoble Alpes, Univ. Savoie Mont Blanc, CNRS,  
Grenoble INP, LEPMI, 38000 Grenoble, France

Project with students: IUT Chambéry

Yvan RECH, Sarah FRÉDÉRIC, Lola VIVENOT

## Instrumentation

Design of a setup to couple:

- Electric measurements
- Elongation as a function of temperature and under inert gas

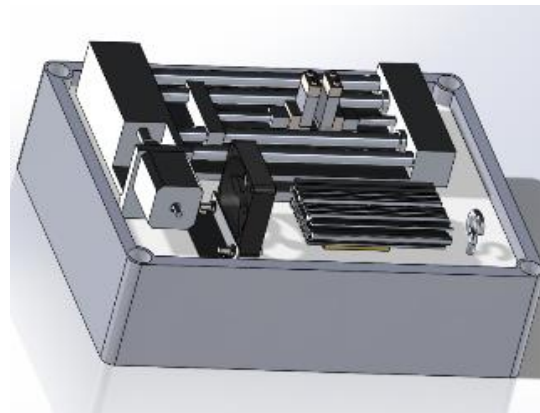

Schedule on SolidWorks

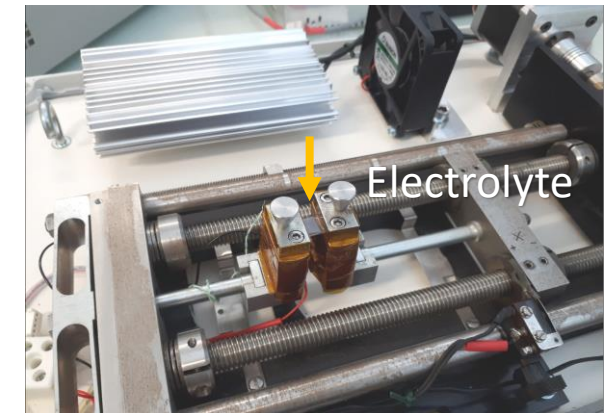

Real instrument

## Electrochemistry measurement

- $\sigma_{//} > \sigma_{\perp}$  for all PEO based SPEs (homopolymer, composite, statistical)
- Modeling captures the experimental behavior

## Perspectives

Electrochemistry: Evaluate the other transport properties

Material characterizations for the anisotropy: SAXS and/or Infra red and Raman measurements

### Copolymer PEO-PPO

