

Superconducting Power Filter for HVDC and Onboard DC Grids

L. Quéval^{1,2}, B. Douine³, I. Schwenker³, D. Huchet^{1,2}, F. Trillaud⁴, O. Despouys⁵

¹ Université Paris-Saclay, CentraleSupélec, CNRS, GeePs, Gif-sur-Yvette, France.

² Sorbonne Université, CNRS, GeePs, Paris, France.

³ GREEN, Univ. de Lorraine, Nancy, France

⁴ Instituto de Ingeniería, National Autonomous University of Mexico (UNAM), Mexico

⁵ Réseau de Transport d'Electricité, Paris la Défense, France

Device

Superconducting power filter (ScPF)

Function

Improve the stability of DC grids

- HVDC grids
- onboard DC grids
 - More electric aircraft (MEA)
 - Electric ship



HVDC



Boeing 787



USS Zumwalt

Content

- I. Stability of a DC grid with a constant power load
- II. Stability of a DC grid with a constant power load and a ScPF
- III. Towards an experimental proof of concept
- IV. Conclusion

I. Stability of a DC grid with a constant power load

Case study: 2-terminal HVDC link

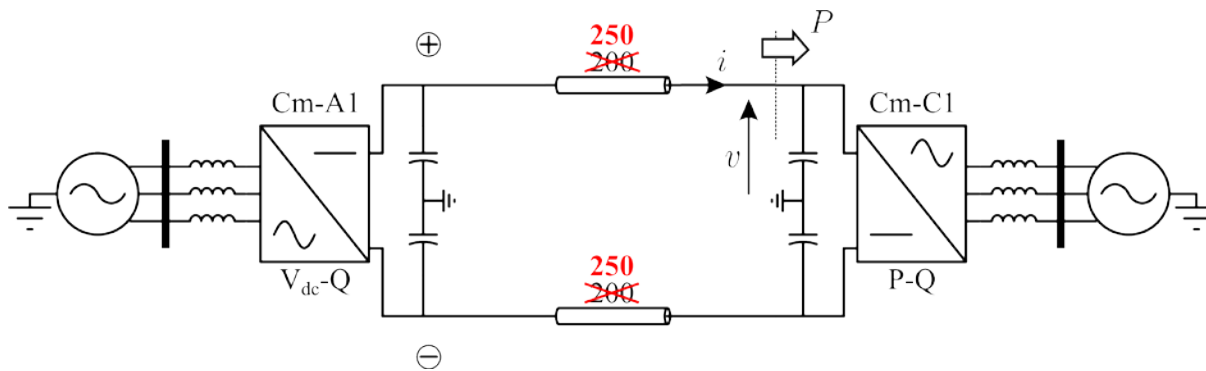

AC/DC converter station	Power rating [MVA]	Operation mode setpoints
Cm-A1	800	$V_{dc} = 1$ pu and $Q = 0$ pu
Cm-C1	800	P variable and $Q = 0$ pu

CIGRE B4 DC grid test system DCS1

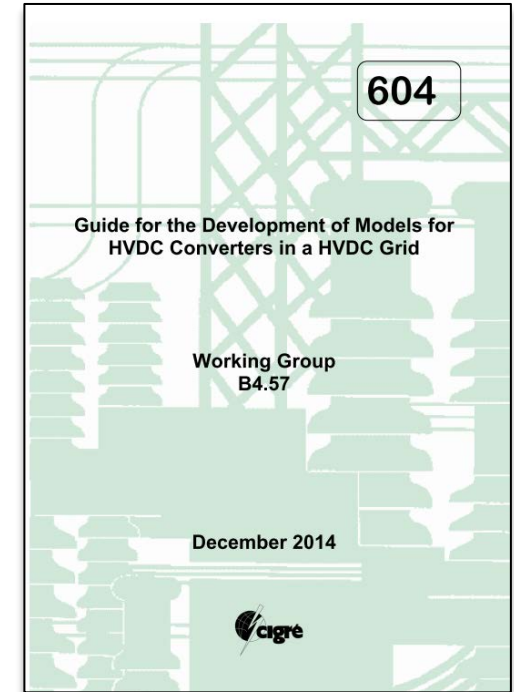

+ few extra simplifications

[1] L. Quéval, O. Despouys, F. Trillaud, B. Douine, "Feasibility study of a superconducting power filter for HVDC grids," 22nd European Conference on Power Electronics and Applications (EPE'20 ECCE Europe), Lyon, France, Sept. 2020.

Stability analysis

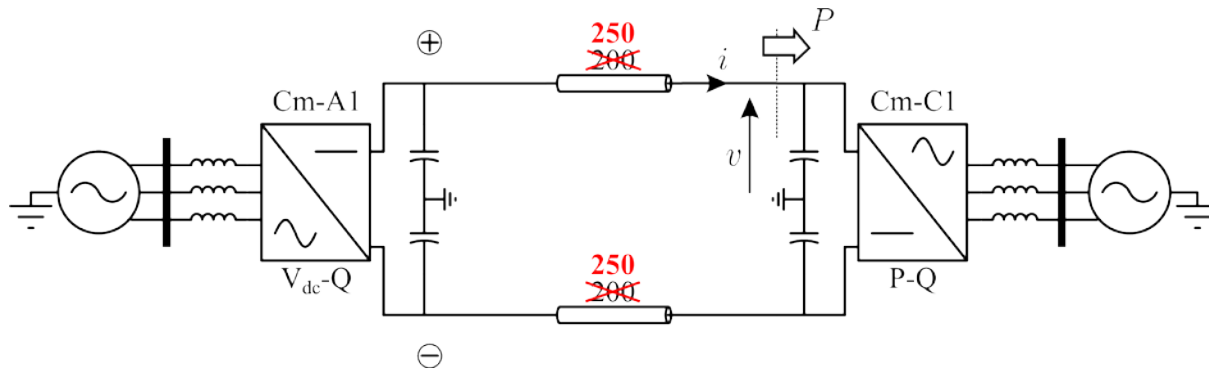

Equivalent circuit of the positive pole:

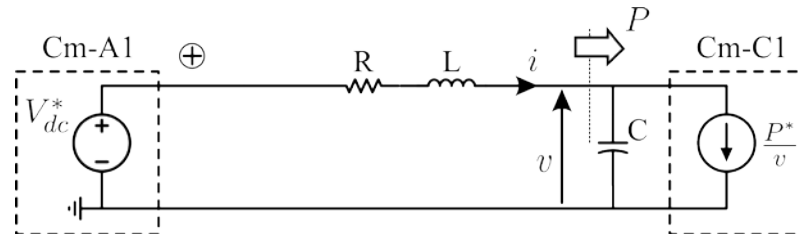

DC voltage is stable if:
$$P \leq \frac{RC}{L} V_{dc}^2$$

[1] M. Cupelli, F. Ponci, G. Sulligoi, A. Vicenzutti, CS. Edrington, T. El-Mezyani, A. Monti, "Power flow control and network stability in an all-electric ship," *Proceedings of the IEEE*, vol. 103, no. 12, pp. 2355-2380, Dec. 2015.

Stability analysis

Results for positive pole only

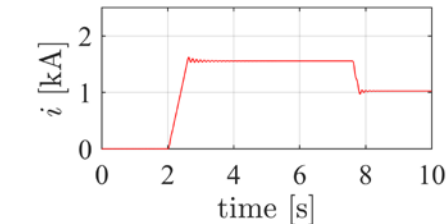
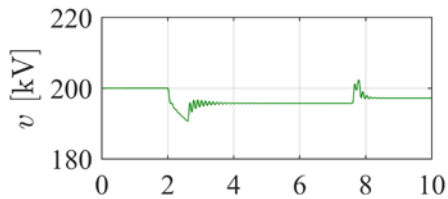
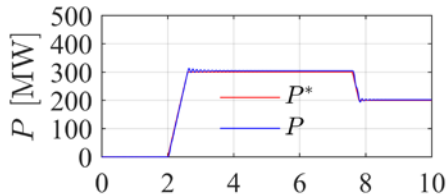
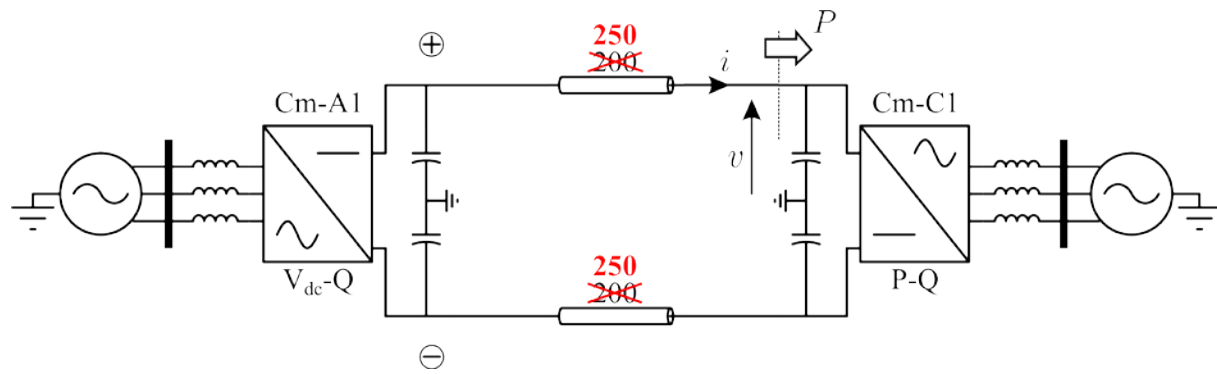

➔ DC voltage
stable

$P^* = 300$ MW: stable

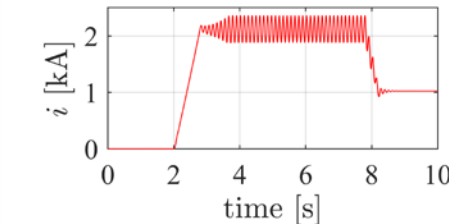
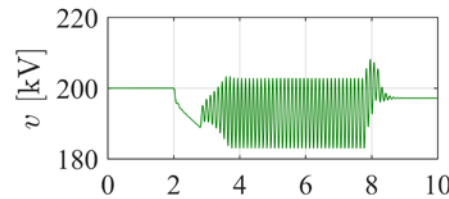
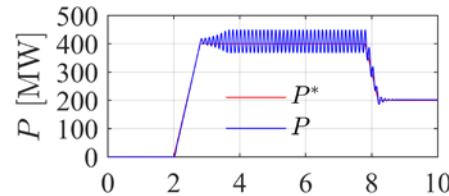

➔ DC voltage
unstable

$P^* = 400$ MW: unstable 🤔

[1] L. Quéval, O. Despouys, F. Trillaud, B. Douine, "Feasibility study of a superconducting power filter for HVDC grids," 22nd European Conference on Power Electronics and Applications (EPE'20 ECCE Europe), Lyon, France, Sept. 2020.

Superconducting Power Filter (ScPF)

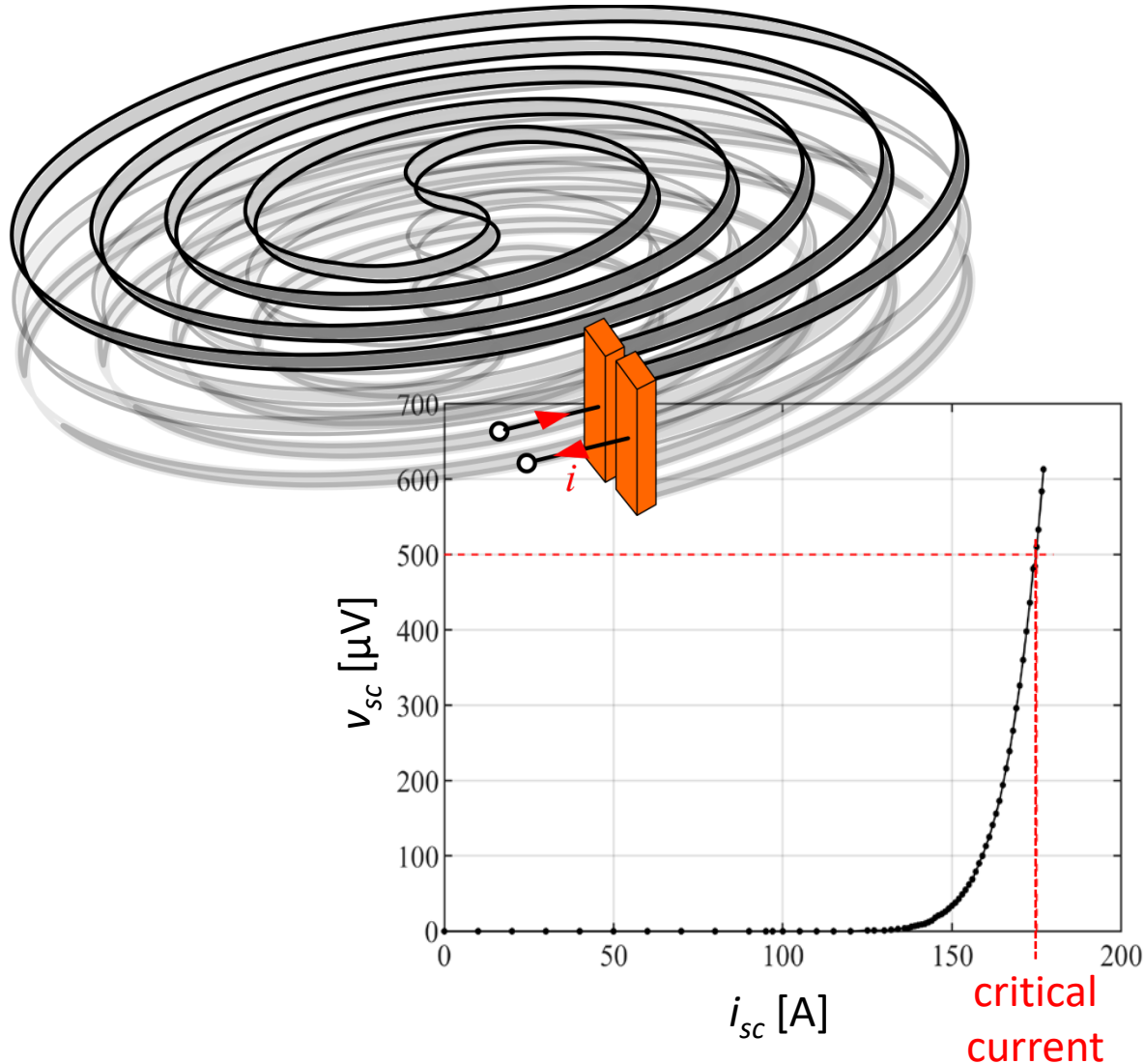

- non-inductive superconducting coil + RLC

$$P \leq \frac{RC}{L} V_{dc}^2$$

- behaves as a current dependent resistance

Superconducting Power Filter (ScPF)

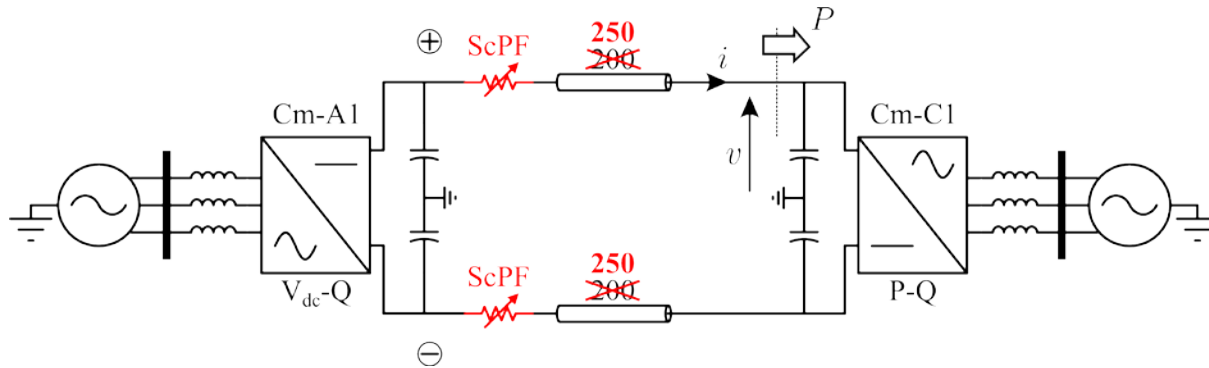

Equivalent circuit of the positive pole:

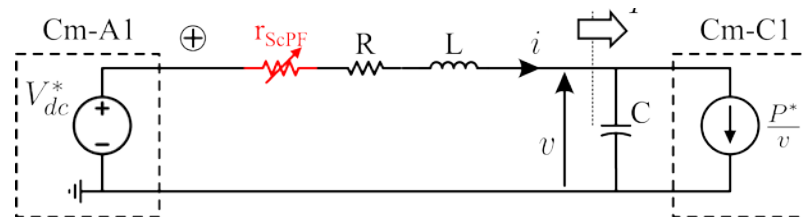

DC voltage is stable if:
$$P \leq \frac{[R + r_{ScPF}(i)]C}{L} V_{dc}^2$$

➔ The stability limit becomes higher!

[1] L. Quéval, F. Trillaud, B. Douine, "DC grid stabilization using a resistive superconducting fault current limiter," *International Conference on Components and Systems for DC grids (COSYS-DC 2017)*, Grenoble, France, March 2017.

II. Stability of a DC grid with a constant power load and a superconducting power filter

II. Stability of a DC grid with a CPL & a ScPF

1. ScPF lumped parameter thermo-electric model

Electric model

$$v(i) = \frac{E_c L_{sc}}{I_c(T)} \left| \frac{i}{I_c(T)} \right|^{n(T)-1} i$$

$$I_c(T) = I_{c0} \left(\frac{92 \text{ K} - T}{92 \text{ K} - 77 \text{ K}} \right)^{\frac{77 \text{ K}}{T}}$$

$$n(T) = n_0 \frac{77 \text{ K}}{T}$$

Current sharing

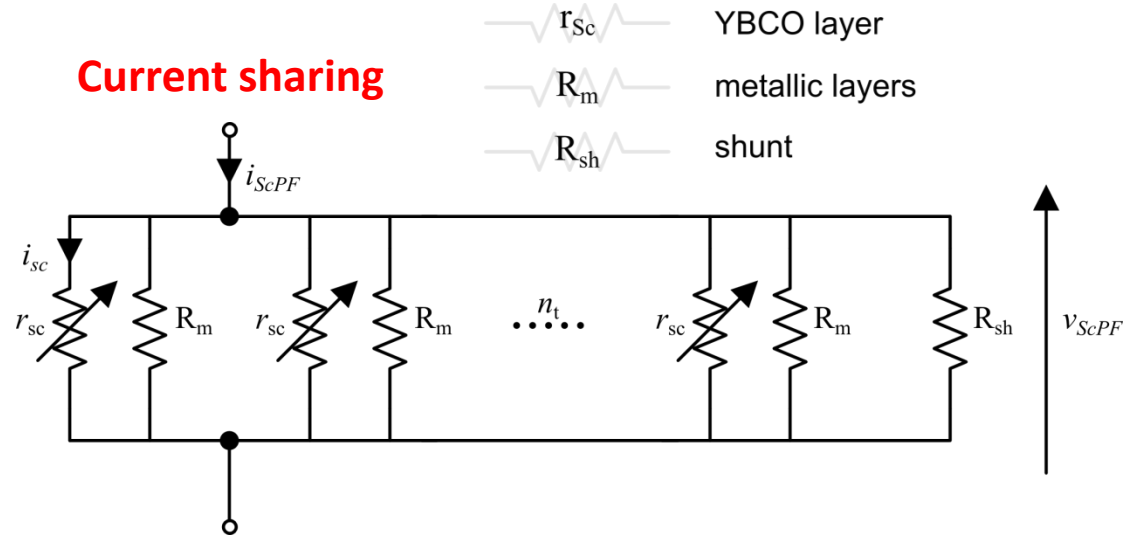

Thermal model

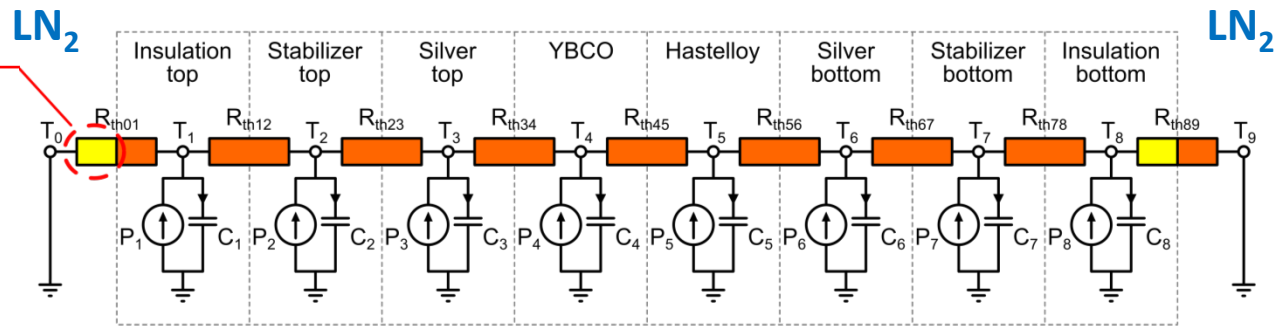
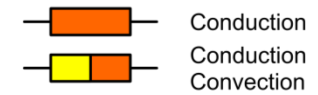
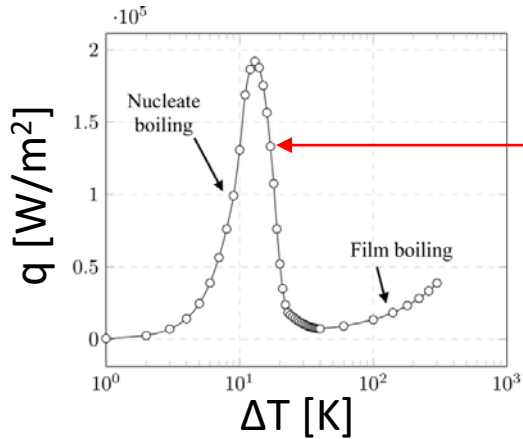

[1] J.J. Pérez-Chavez, F. Trillaud, L.M. Castro, L. Quéval, A. Polasek, R. de Andrade Jr, "Generic model of Three-phase (Re)BCO Resistive Superconducting Fault Current Limiters for Transient Analysis of Power Systems," *IEEE Trans. on Applied Superconductivity*, vol. 29, no. 6, 2019.

II. Stability of a DC grid with a CPL & a ScPF

2. Simulation results

Stability analysis with ScPF

Results for positive pole only

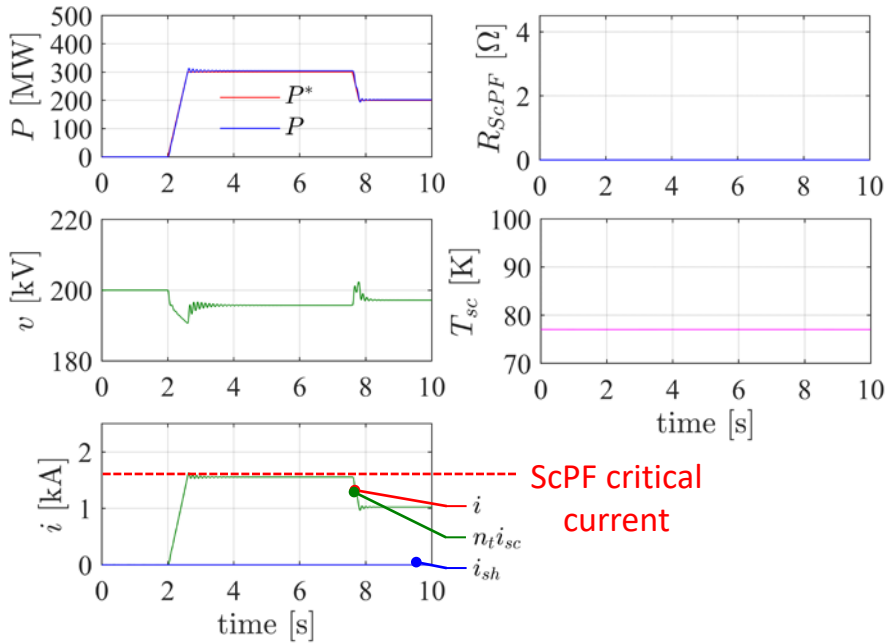
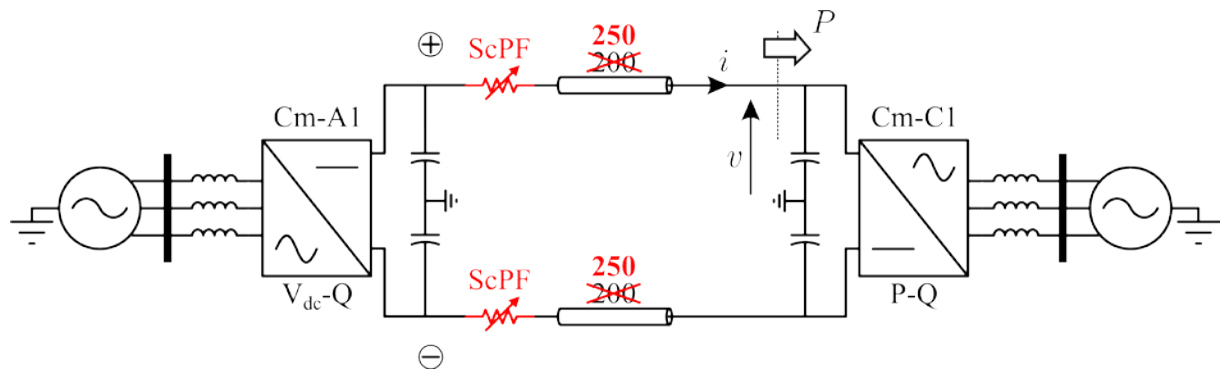

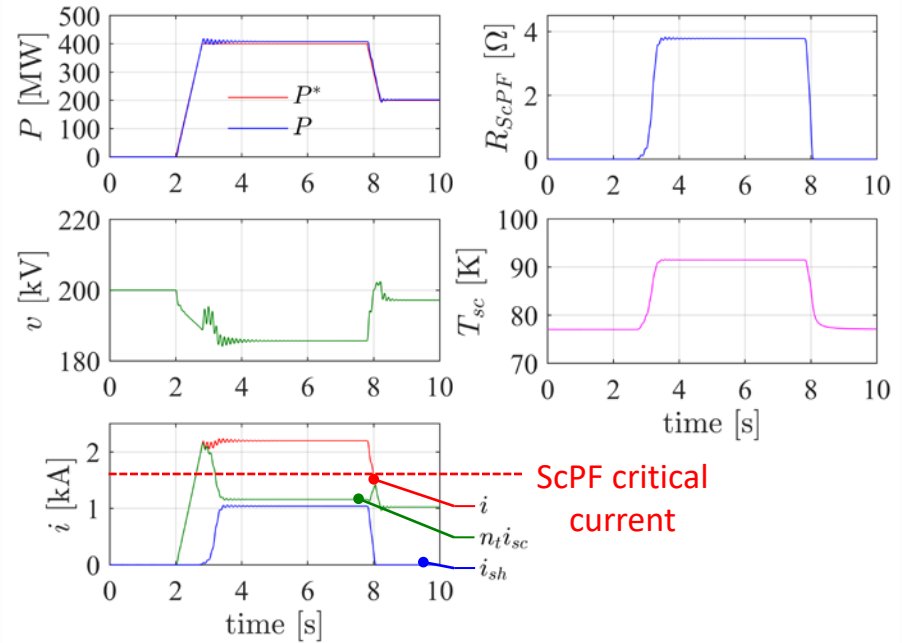

$P^* = 300 \text{ MW}$: stable



$P^* = 400 \text{ MW}$: stable 😊

[1] L. Quéval, O. Despouys, F. Trillaud, B. Douine, "Feasibility study of a superconducting power filter for HVDC grids," 22nd European Conference on Power Electronics and Applications (EPE'20 ECCE Europe), Lyon, France, Sept. 2020.

Stability analysis with ScPF

Symb	Parameter	HVDC 	MEA  Boeing 787	Ship  USS Zumwalt
V _{dc}	Nominal DC bus voltage [V]	200e3	540	10e3
P _{nom}	Nominal power [W]	800e6	125e3	16e6
I _{c0}	Tape critical current [A]	200	300	300
N _t	Nb of tapes in parallel [-]	8	1	1
L _{sc}	Tape length [m]	3500	30.5	31.5
R _{sh}	Shunt resistance [Ω]	8	5e-4	32e-3

[1] L. Quéval, O. Despouys, F. Trillaud, B. Douine, "Feasibility study of a superconducting power filter for HVDC grids," *22nd European Conference on Power Electronics and Applications (EPE'20 ECCE Europe)*, Lyon, France, Sept. 2020.

[2] F. Trillaud, B. Douine, L. Quéval, "Superconducting power filter for aircraft electric DC grids" *IEEE Transactions on Applied Superconductivity*, vol. 31, no. 5, pp. 1-5, Aug. 2021.

III. Towards an experimental proof of concept

Specifications

- Non-inductive coil > Ying Yang configuration
- BSCCO or YBCO (77 K)
- 100 m

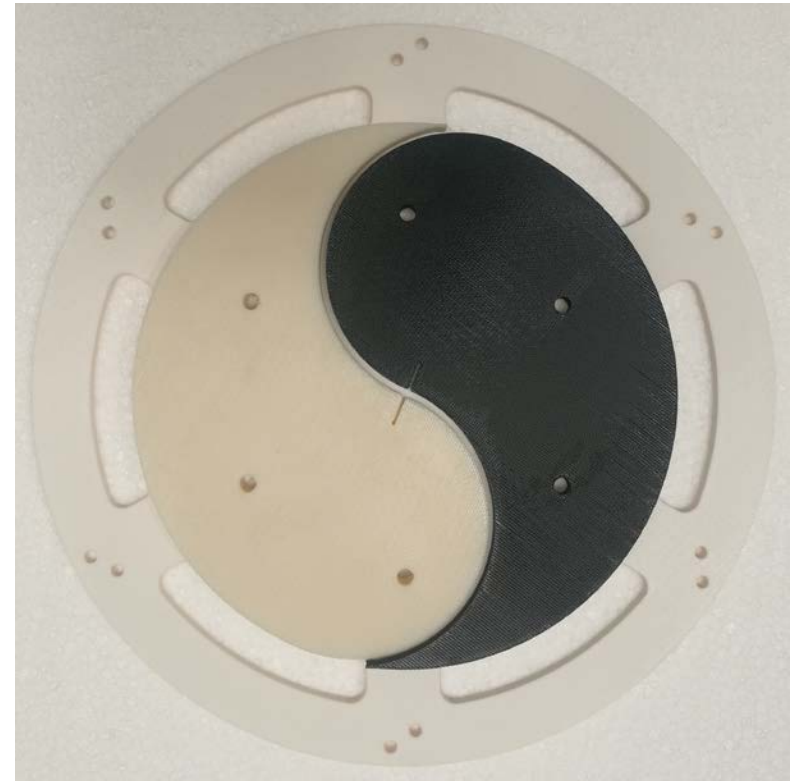
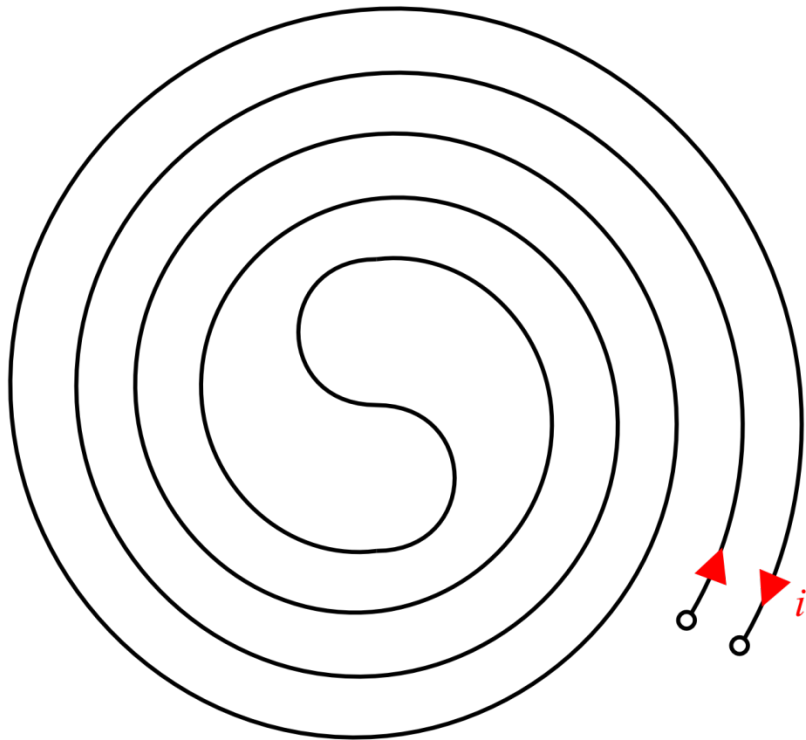

Prototype ScPF#1

- BSCCO
- $I_c = 63 \text{ A}$
- $L_{sc} = 5.2 \text{ m}$

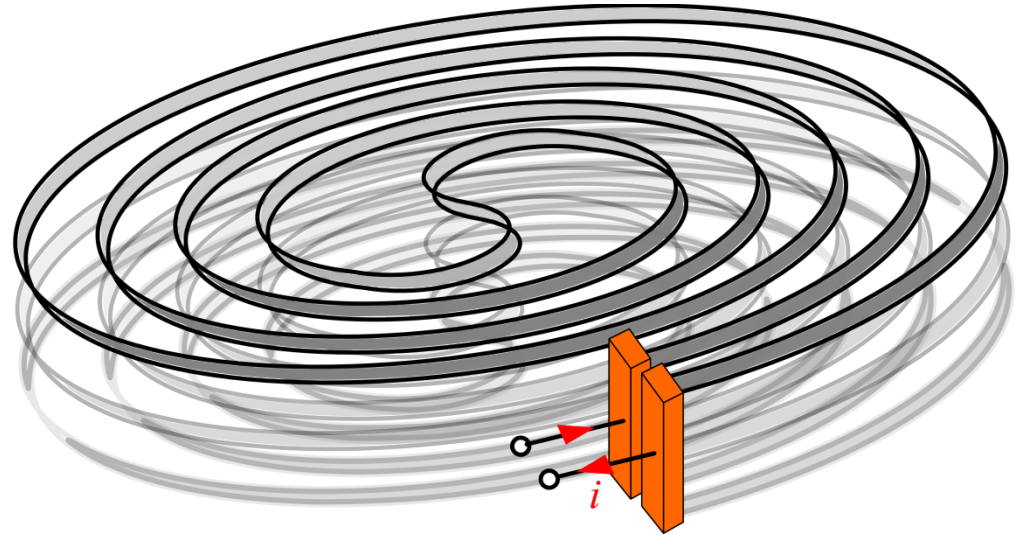

Validate winding ✓
Characterize I_c ScPF ✓

[1] G.B. Huang, B. Douine, K. Berger, G. Didier, I. Schwenker, J. L ev eque, "Increase of stability margin in embedded DC electric grid with superconducting stabilizer," *IEEE Trans. on Applied Superconductivity*, vol. 26, no. 4, June 2016.

Prototype ScPF#2

- ReBCO (Shanghai SC)
- $I_c < 90 \text{ A}$
- $L_{sc} = 9 \text{ m}$

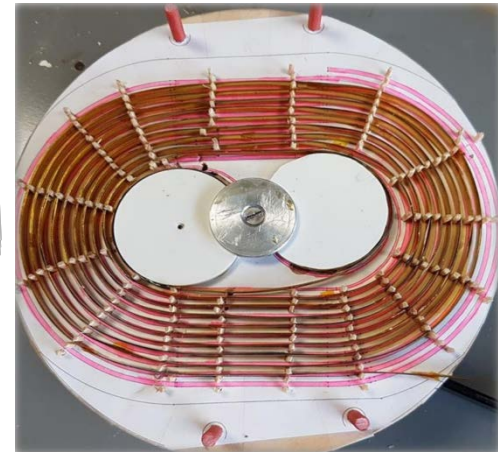
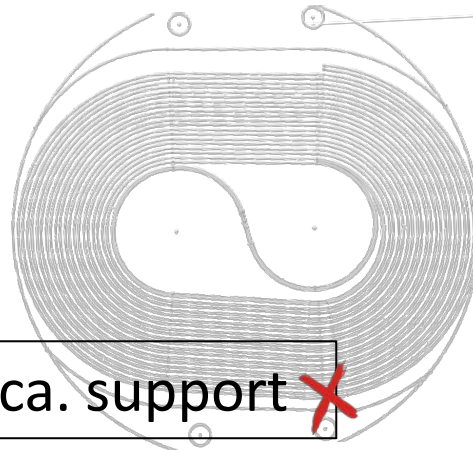
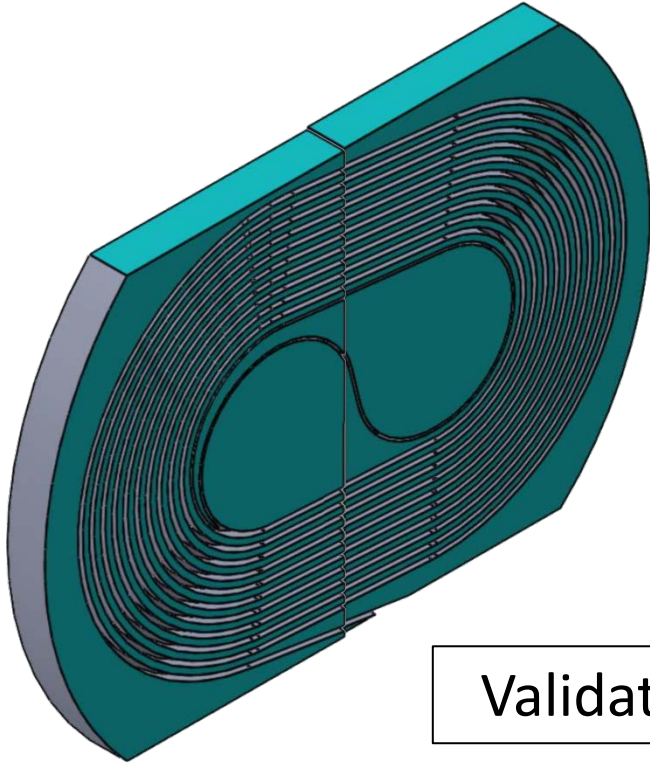

Validate meca. support ~~X~~

[1] El Harouch Abdessamad, Ikram Hamdaoui Aloui, "Réalisation et caractérisation d'une bobine supraconductrice non inductive," Rapport de projet de fin d'étude de Master, GREEN, Univ. of Lorraine, Nancy, 2018.

Prototype ScPF#3a

- BSCCO (Sumitomo)
- $I_c = 175$ A (datasheet 170 A)
- $L_{sc} = 5$ m

Validate meca. support ✓

Characterize I_c ScPF ✓

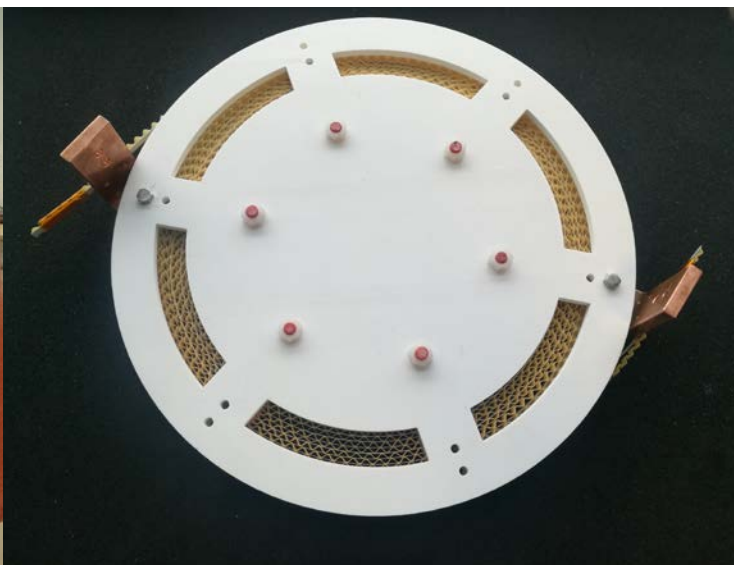
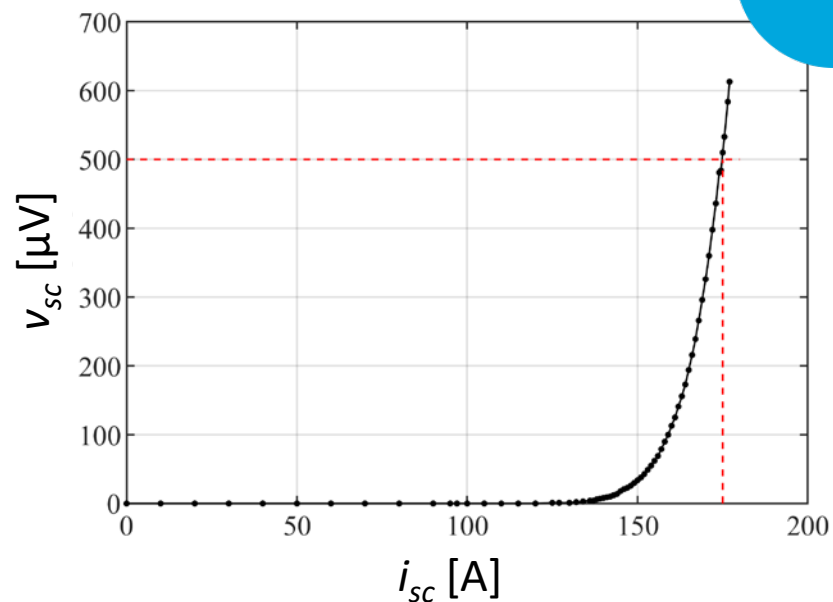

Prototype ScPF#3c

- BSCCO (Sumitomo)
- $I_c = 154$ A (datasheet 170 A)
- $L_{sc} = 25$ m (diameter: 40 cm)

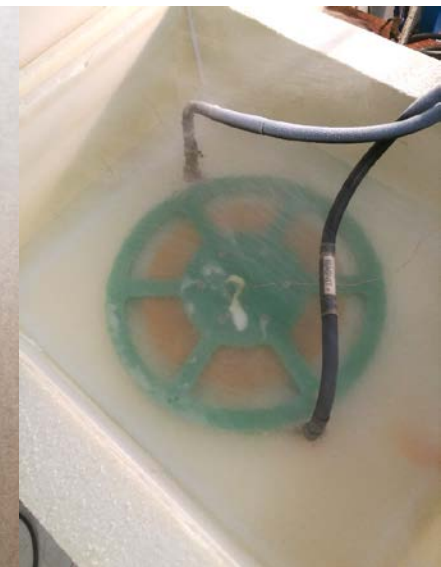
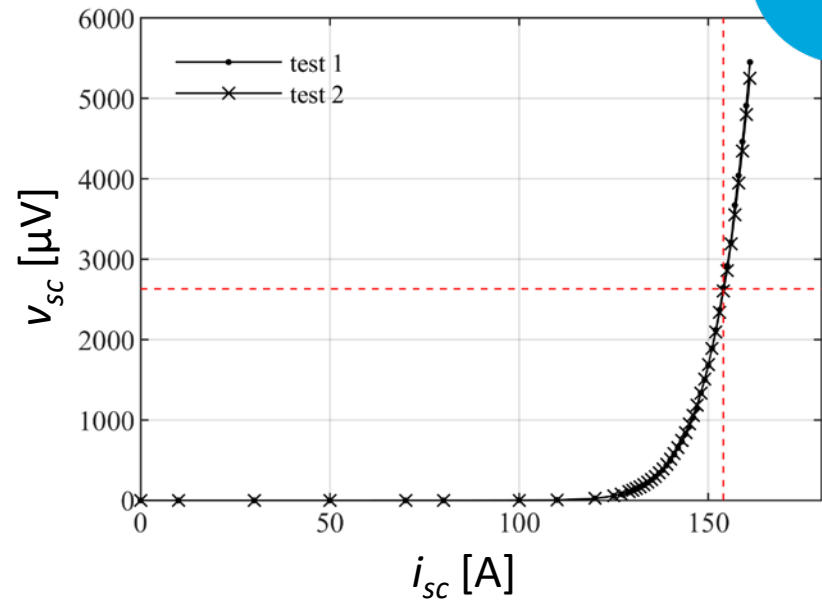

Prototype ScPF#4a

- ReBCO (SuNAM)
- $I_c = 129$ A (datasheet: 199 A)
- $L_{sc} = 2$ m

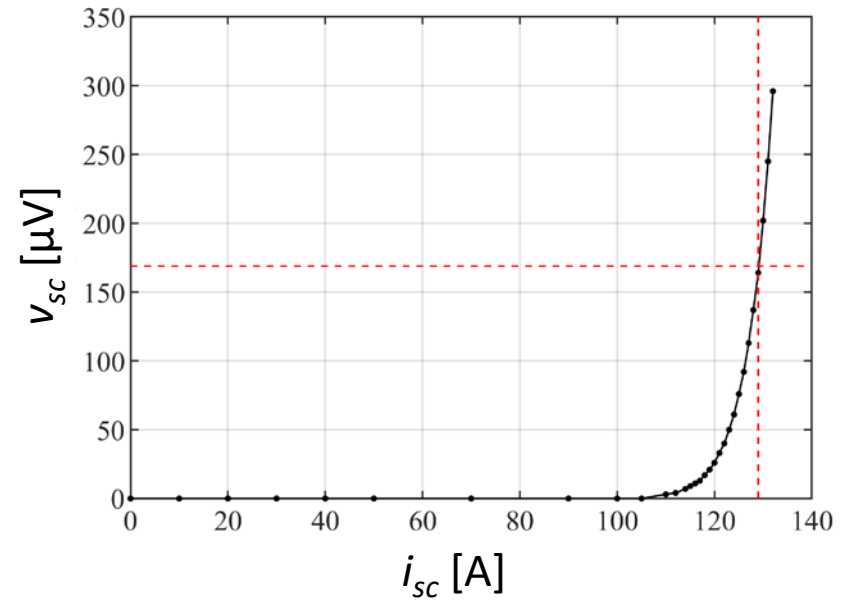

[1] V. Naude, T. Benramdane, "Etude de faisabilité d'un filtre supraconducteur pour les réseaux à courant continu haute tension," Projet 3A, GeePs, CentraleSupélec, 2020.

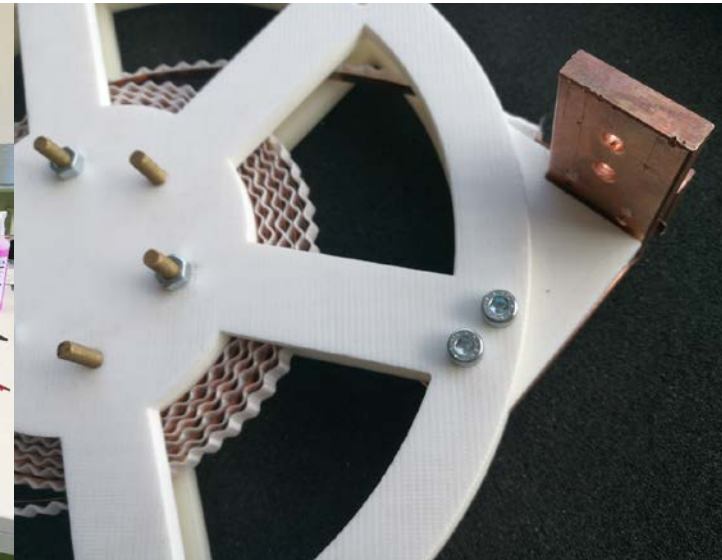
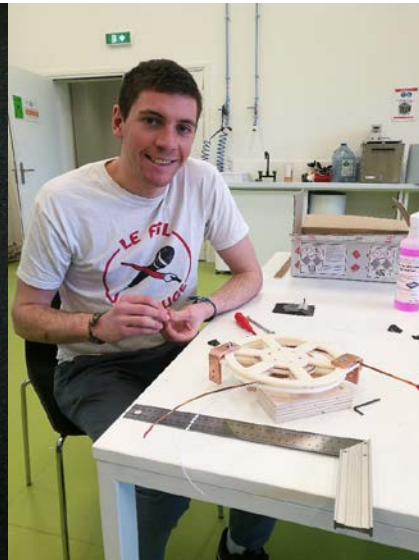
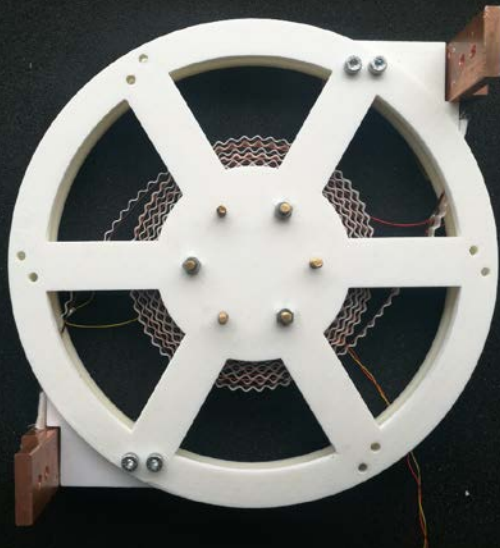

Future works

- Winding and characterization of a full-scale ScPF (BSCCO, 100 m)
- Experimental proof-of-concept of the proposed function

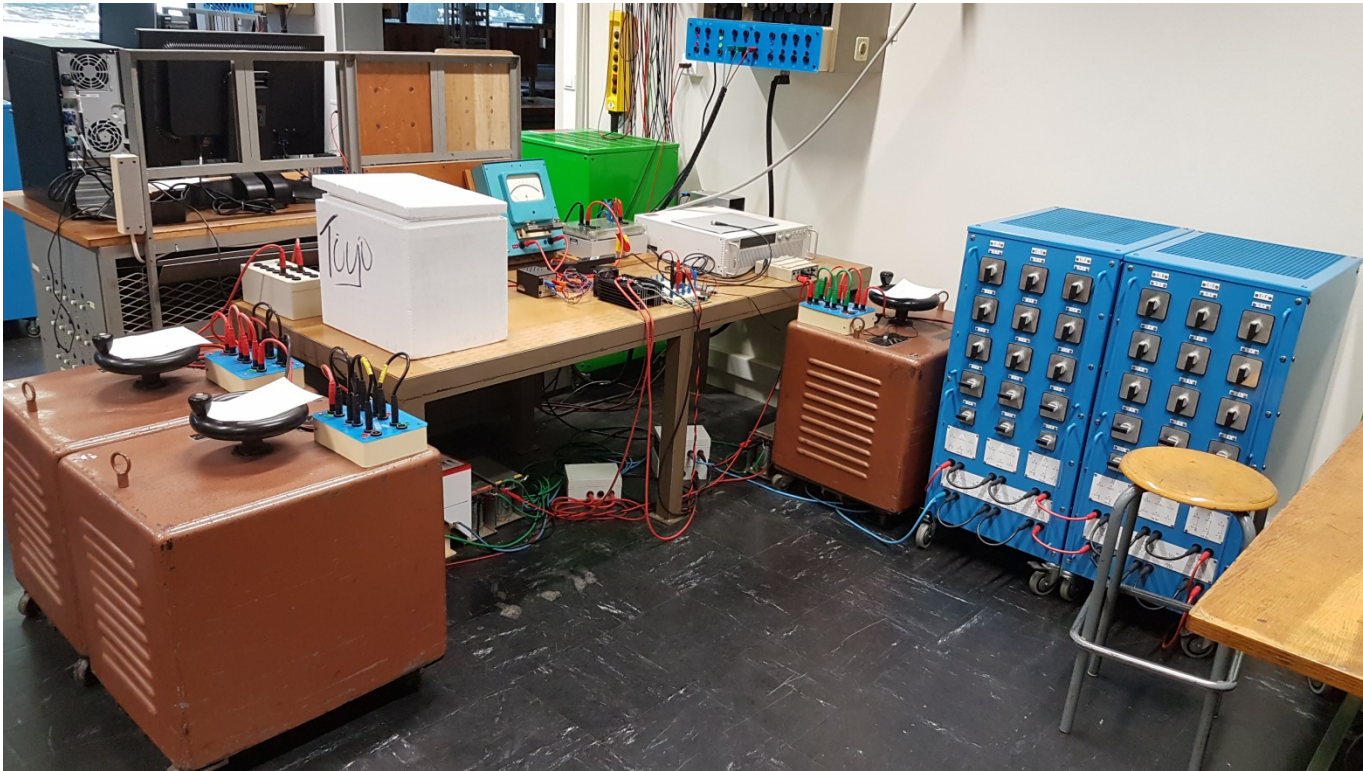

IV. Conclusion

Conclusion

- A new application of HTS technology is introduced. The device referred to as "Superconducting power filter" (ScPF) aims at increasing the stability of DC grids by adding a current-dependent resistance to a classical RLC filter.
- In comparison with other stabilization techniques, a ScPF achieves a fully passive stabilization without decreasing the energy transferred to the load in nominal operation.
- To clarify its operation, a simple DC circuit with a controlled power load (CPL) and a ScPF was considered. Using an thermo-electric lumped-parameter model of the ScPF, the stability of the DC grid was assessed for a given test case.
- Efforts are underway to provide an experimental proof of concept.

References

- [1] G.B. Huang, B. Douine, K. Berger, G. Didier, I. Schwenker, J. Lévêque, “Increase of stability margin in embedded DC electric grid with superconducting stabilizer,” *IEEE Trans. on Applied Superconductivity*, vol. 26, no. 4, 2016.
- [2] L. Quéval, F. Trillaud, B. Douine, “DC grid stabilization using a resistive superconducting fault current limiter,” *Intl. Conf. on Components and Systems for DC grids (COSYS-DC 2017)*, Grenoble, France, March 2017.
- [3] J.J. Perez-Chavez, F. Trillaud, L.M. Castro, L. Quéval, A. Polasek, R. de Andrade Jr, “Generic model of three-phase (RE)BCO resistive superconducting fault current limiters for transient analysis of power systems,” *IEEE Transactions on Applied Superconductivity*, vol. 29, no. 6, id. 5601811, Sept. 2019.
- [4] L. Quéval, F. Trillaud, J.J. Pérez-Chavez, B. Douine, “Superconducting power filter for DC electrical grids,” *13th European Conf. on Applied Superconductivity (EUCAS2017)*, Geneva, Switzerland, Sept. 2017.
- [5] L. Quéval, F. Trillaud, B. Douine, “Progress towards the realization of a DC superconducting power filter,” *14th European Conference on Applied Superconductivity (EUCAS2019)*, id. 3-LO-TG-05S, Glasgow, UK, Sept. 2019.
- [6] L. Quéval, O. Despouys, F. Trillaud, B. Douine, “Feasibility study of a superconducting power filter for HVDC grids,” *22nd European Conference on Power Electronics and Applications (EPE’20 ECCE Europe)*, Lyon, France, Sept. 2020.
- [7] F. Trillaud, B. Douine, L. Quéval, “Superconducting power filter for aircraft electric DC grids” *IEEE Transactions on Applied Superconductivity*, vol. 31, no. 5, pp. 1-5, Aug. 2021.

Merci !

