



HAL
open science

FORCE PREDICTION IN THREAD MILLING

Anna Carla Araujo, Jose Luis Silveira, Shiv Gopal Kapoor

► **To cite this version:**

Anna Carla Araujo, Jose Luis Silveira, Shiv Gopal Kapoor. FORCE PREDICTION IN THREAD MILLING. 2 Congresso Brasileiro de Fabricação COBEF, Apr 2003, Uberlandia, Brazil. hal-03212294

HAL Id: hal-03212294

<https://hal.science/hal-03212294>

Submitted on 29 Apr 2021

HAL is a multi-disciplinary open access archive for the deposit and dissemination of scientific research documents, whether they are published or not. The documents may come from teaching and research institutions in France or abroad, or from public or private research centers.

L'archive ouverte pluridisciplinaire **HAL**, est destinée au dépôt et à la diffusion de documents scientifiques de niveau recherche, publiés ou non, émanant des établissements d'enseignement et de recherche français ou étrangers, des laboratoires publics ou privés.



FORCE PREDICTION IN THREAD MILLING

Anna Carla Araujo

anna@ufrj.br

Programa de Engenharia Mecânica/COPPE/UFRJ

University of Illinois at Urbana Champaign

Jose Luis Silveira

jluis@ufrj.br

Programa de Engenharia Mecânica/COPPE/UFRJ

P.O. Box 68503 – 21945-970 Rio de Janeiro, RJ, Brazil

Shiv Kapoor

s-kapoor@uiuc.edu

Department of Mechanical and Industrial Engineering,

University of Illinois at Urbana Champaign

Urbana, IL 61801

Abstract. *A mechanistic approach for modelling the thread milling process is presented. The mechanics of cutting for thread milling is analyzed as an end milling process with modified cutting edge. The geometry of threads is added to the geometry of the end milling tool to calculate the chip load area. The linear path is simulated and values of the specific energy from end milling are used to compute the cutting forces involved. A comparison between the simulation of the cutting forces for a specific tool in two different situations is made to present the force behavior acquired from the model.*

Keywords: *Thread Milling, Mechanistic Models, Force Prediction.*

1. INTRODUCTION

Threading a work piece is a fundamental metalworking process. Threads can be produced in a variety of ways, involving two basic methods: plastic working or metal cutting. The dominant method used in industry is plastic working. Conventional bolts and screws, for example, are mostly made by this method. Threads produced by plastic deformation are stronger because of the grain structure than those produced by cutting, although forming cannot achieve the high accuracy and precision required in many applications. Threads made of brittle materials also cannot be produced by plastic working. In such cases, thread cutting is necessary (Smith, 1989). The common cutting processes for producing internal threads are tapping and thread milling (Stephenson, 1996). Tapping is used to make internal threads with the same diameter of the tool. It is done by feeding the cutting tool into the hole until the desired thread depth is achieved, then reversing the tap to back it out of the hole and remove it from the workpiece. Thread milling tools can produce internal threads with any diameter bigger than tool diameter as well as external threads. In thread milling,

the machine tool executes the thread in one single pass. The tool goes down to the hole and begins the cutting from the deepest part to the top in a helical path, or it begins at the top and goes until the end of the hole. Some geometries of thread milling tools can be observed in Figure (1). Figure (1a) shows a single cutting edge which produces one pitch per feed rotation, Figure (1b) presents a single straight tool with only one cutting edge and Figure (1c) shows a helical thread tool with some cutting flutes. In thread milling high tool pressure are generated which can result into an excessive tool deflection and tool breakage when milling at full thread.

Many authors developed models for prediction of forces in machining. These include analytical, experimental, mechanistic and numerical methods (Ehmann, 1997). In thread cutting by tapping, a mechanistic method for the prediction of forces was presented by Dogra (2002). A number of papers describing the thread milling operation have been published (Smith, 1989, Koelsch, 1995, Stephenson, 1996) but there is no model to predict the forces involved in the process.

The objective of this article is to present a mechanistic model for thread milling. The tool geometry analyzed involves triangular and metric threads. The thread milling tool in this article has helical flutes and its geometry is analyzed as a modified end milling tool. This follows with the description of cutting geometry. Tool run out is added to the model and some examples of thread milling processes are presented.

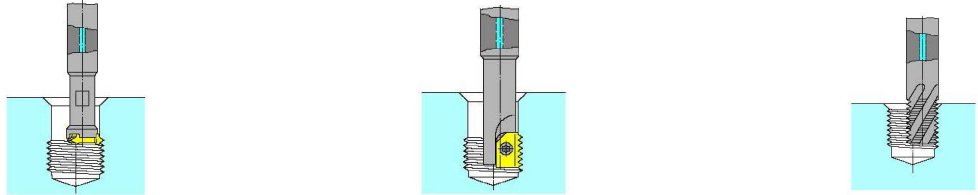

(a) Single Cutting Edge (b) Single Straight Thread Flute (c) Helical Thread Flute

Figure 1 - Thread Milling Tools (Emuge, 2002)

2. THREAD MILLING GEOMETRY

2.1 Tool Geometry

The threads studied in this article are metric and triangular. The thread variables presented in figure (2a) are: thread pitch, p , thread angle, ξ , external workpiece diameter, d_E , internal workpiece diameter, d_I , and thread height H .

The relation between the diameters can be written as:

$$d_I = d_E - \frac{p}{\tan(\frac{\xi}{2})} \tag{1}$$

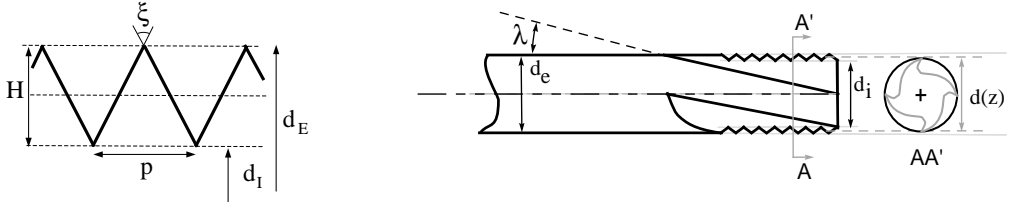

(a) Thread Geometry (b) Tool Geometry

Figure 2 - Tool and Thread Geometries

The thread milling tool is very similar to an end milling tool. The tool geometry of a helical thread flute is presented in figure (2b). The helix angle λ , the rake angle α , the internal and external diameters d_i and d_e and the numbers of flutes N_f define the tool geometry. The angle between flutes is:

$$\zeta = \frac{2\pi}{N_f} \quad (2)$$

and the number of each flute is n , $1 \leq n \leq N_f$. The local diameter $d(z)$ is written as a function of the height z , $d_i \leq d(z) \leq d_e$, calculated as follows:

$$d(z) = \begin{cases} d_i + \frac{2(z-nt(z)\frac{p}{2})}{\tan(\frac{\xi}{2})}, & \text{if } nt(z) \text{ is odd;} \\ d_e - \frac{2(z-nt(z)\frac{p}{2})}{\tan(\frac{\xi}{2})}, & \text{if } nt(z) \text{ is even;} \end{cases} \quad (3)$$

where $nt(z)$ is:

$$nt(z) = \text{IntegerPart} \left(\frac{2z}{p} \right) \quad (4)$$

The tool motion is circular in the plane normal to the tool-axis and linear in the direction of the tool-axis with a stationary workpiece to generate the thread. The workpiece is pre-drilled and the diameter of the hole is called d_h . The width of cut (or radial depth of cut) is $e(z)$:

$$e(z) = \frac{d(z) - d_h}{2} \quad (5)$$

2.2 Cutting geometry

The cutting geometry of the thread milling process is different than the common end milling because the cutting edge is not a straight line and the tool follows a circular trajectory. Following the approach used by Tlustý (1975) the contact interface in thread milling process can be described as shown in Figure (3), where can be observed the depth of cut, b .

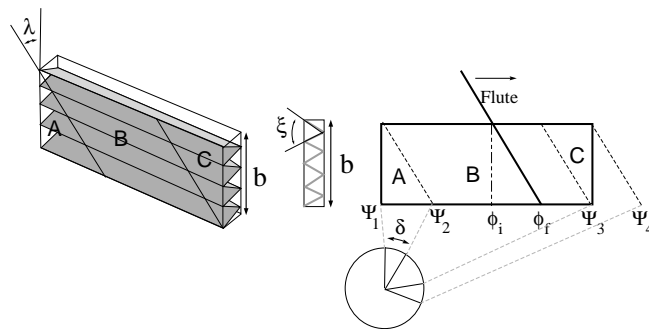

Figure 3 - Contact Plane

The contact surface is divided in three phases: **A**, where the length of active cutting edge increases in time, **B**, where it is constant, and **C** where it decreases. There are two different types of contact surface geometry according to the relation between the angle δ , defined in Equation 6, and the contact angle: *Type I* and *Type II*. It is a *Type I* geometry if $\delta \leq \varphi_2$, and *Type II* occurs if $\delta \geq \varphi_2 - \varphi_1$.

$$\delta = \frac{2b \tan \lambda}{d_e} \quad (6)$$

The contact angle is defined as the difference between the initial angle φ_1 and the final angle φ_2 . Two auxiliary angles were defined by Tlustý (1975) to analyze the flute movement through the three phases **A**, **B** and **C**. The first one is angle Ψ , which indicates the angular position of the leading point of the cutting edge. The other one is angle ϕ , which indicates the position of the other points of the same flute. For a known Ψ , the range of values for ϕ is between ϕ_i and ϕ_f , and it changes for each phase and each position θ of the tool as shown in Table 1.

Table 1 - Limits of $\phi_i(\theta)$ and $\phi_f(\theta)$ in **A**, **B** and **C**.

Phase	Type I		Type II	
	$\phi_i(\theta)$	$\phi_f(\theta)$	$\phi_i(\theta)$	$\phi_f(\theta)$
For $\Psi_1 < \theta \leq \Psi_2$ - Phase A	φ_1	θ	φ_1	θ
For $\Psi_2 < \theta \leq \Psi_3$ - Phase B	$\theta - \delta$	θ	φ_1	φ_2
For $\Psi_3 < \theta \leq \Psi_4$ - Phase C	$\theta - \delta$	φ_2	$\theta - \delta$	φ_2

The range of values for Ψ in each phase is shown on Table 2 and the limits of each phase are called Ψ_1 , Ψ_2 , Ψ_3 and Ψ_4 .

Table 2 - Values of Ψ_1 , Ψ_2 , Ψ_3 and Ψ_4 for Type I and II

	Type I	Type II
Ψ_1	φ_1	φ_1
Ψ_2	$\varphi_1 + \delta$	φ_2
Ψ_3	φ_2	$\varphi_1 + \delta$
Ψ_4	$\varphi_2 + \delta$	$\varphi_2 + \delta$

For a helical tool, the height z can be expressed as a function of the position of the tool θ and the point angle ϕ :

$$z(\theta, \phi) = \frac{d_i(\theta - \phi)}{2 \tan \lambda} \quad (7)$$

In the case I, shown in figure (4a), the tool feed velocity does not change direction, as occurs in end milling. In case II the tool cuts in a the circular path, figure (4b).

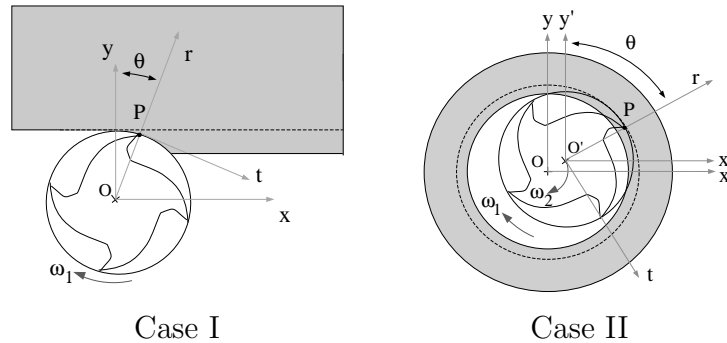

Figure 4 - Tool Path Cases

Case I: For up milling the initial angle is zero. In case I the final angle is written as:

$$\varphi_2 = \frac{b \tan \lambda}{re} \quad (8)$$

Case II: In case II, the final angle is written as: (Figure 5)

$$\varphi_2 = \arcsin \left(\frac{d_h^2 - d_i^2 - 4r_o}{4d_h r_o} \right) \quad (9)$$

where $r_o = \frac{d_E - d_e}{2}$.

The uncut chip thickness for any point of the cutting edge, located in the height z and by the angle ϕ (Figure 5), can be written as: (Sabberwall, 1960)

$$t(\phi, z) = f_t(z) \sin \phi \quad (10)$$

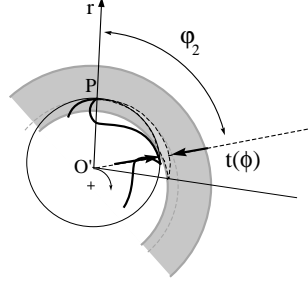

Figure 5 - Chip Thickness for Case II

3. FORCE PREDICTION

Elemental normal and frictional forces are required to the determination of cutting forces for a given geometry. The mechanistic modelling approach is a combination of analytical and empirical methods in which the forces are proportional to the chip load (Kline, 1983). The specific cutting energies, K_n , K_f and K_z , have been shown as a function of chip thickness t_c and cutting velocity V_c . (Dogra, 2002)

$$\begin{aligned} F_n(\theta) &= K_n \cdot A(\theta) \\ F_f(\theta) &= K_f \cdot A(\theta) \end{aligned} \quad (11)$$

$$\begin{aligned} \ln(K_c) &= a_0 + a_1 \ln(t_c) + a_2 \ln(V_c) + a_3 \ln(t_c) \ln(V_c) \\ \ln(K_f) &= b_0 + b_1 \ln(t_c) + b_2 \ln(V_c) + b_3 \ln(t_c) \ln(V_c) \end{aligned} \quad (12)$$

The coefficients a_0 , a_1 , a_2 , a_3 , b_0 , b_1 , b_2 and b_3 are called specific cutting energy coefficients. They are dependent on the tool and workpiece materials and also on the cutting speed and the chip thickness. They are determined from calibration tests for a given tool workpiece combination and for given a range of cutting conditions.

3.1. Chip Area

The function of chip area for the first flute $A_1(\theta)$ is:

$$A_1(\theta) = \int_{\phi_i(\theta)}^{\phi_f(\theta)} t(\phi, z) db \quad (13)$$

where db is (Sabberwal, 1960):

$$db = \frac{d(z)}{2 \tan \lambda} d\phi \quad (14)$$

Using the Equations 3, 7 and 10, the area $A_1(\theta)$ can be calculated.

$$A_1(\theta) = \int_{\phi_i(\theta)}^{\phi_f(\theta)} t(\phi, z(\theta, \phi)) \frac{d(z(\theta, \phi))}{2 \tan \lambda} d\phi \quad (15)$$

The limits $\phi_i(\theta)$ and $\phi_f(\theta)$ are functions of the θ and the cutting phase of θ , as shown in Table 1. In order to add the contributions of all flutes, the chip cross-sectional area function for each flute (n) is written as:

$$A_n(\theta) = \int_{\phi_i(\theta+\zeta(n-1))}^{\phi_f(\theta+\zeta(n-1))} t(\phi, z(\theta, \phi)) \frac{d(z(\theta, \phi))}{2 \tan \lambda} d\phi \quad (16)$$

In the equation (15) ϕ_i and ϕ_f are also written as a function of n .

The total area $A(\theta)$ is calculated as:

$$A(\theta) = \sum_{n=1}^{N_f} A_n(\theta) \quad (17)$$

3.2. Tool Run Out

Cutter run out exists in all kinds of milling operations and results in variations in undeformed chip thickness, local forces and machined surface characteristics. The run out can be due to cutter axis offset, eccentricity (ϵ) or cutting points positioning offset (ρ), shown in Figure 6, and it depends principally on the characteristics of the spindle and tool holder. The chip thickness in presence of run out is rewritten as: (Kline, 1983)

$$t_c(\theta, \phi, n) = f_t \sin \phi + \rho(\cos(\theta - \epsilon - \phi) - \cos(\theta - \epsilon - \phi - n\zeta)) \quad (18)$$

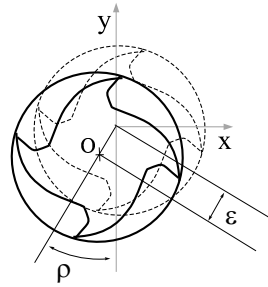

Figure 6 - Tool Run Out

3.3. Force Computation

To calculate the components of the cutting forces using the specific cutting forces K_f , K_n and K_z , a function $A_R(\theta)$ has to be introduced. (Araujo, 2001)

$$F(\theta) = \begin{bmatrix} F_{x'}(\theta) \\ F_{y'}(\theta) \\ F_{z'}(\theta) \end{bmatrix} = \begin{bmatrix} F_x(\theta) \\ F_y(\theta) \\ F_z(\theta) \end{bmatrix} = A(\theta) \begin{bmatrix} K_x \\ K_y \\ K_z \end{bmatrix} = A_R(\theta) \begin{bmatrix} K_f \\ K_n \\ K_z \end{bmatrix} \quad (19)$$

In fact, the function $A_R(\theta)$ is the rotation matrix $\mathbf{R}(\theta)$ multiplied by the area.

$$\mathbf{R}(\theta) = \begin{pmatrix} \cos(\theta) & \sin(\theta) & 0 \\ \sin(\theta) & -\cos(\theta) & 0 \\ 0 & 0 & 1 \end{pmatrix} \quad (20)$$

For each flute the rotation matrix $\mathbf{R}_n(\theta)$ is:

$$\mathbf{R}_n(\theta) = \begin{pmatrix} \cos(\theta + \zeta (n - 1)) & \sin(\theta + \zeta (n - 1)) & 0 \\ \sin(\theta + \zeta (n - 1)) & -\cos(\theta + \zeta (n - 1)) & 0 \\ 0 & 0 & 1 \end{pmatrix} \quad (21)$$

The area for all flutes is written as:

$$A_R(\theta) = \sum_{n=1}^{N_f} \mathbf{R}_n(\theta) A_n(\theta) \quad (22)$$

4. EXAMPLES

In order to analyze the forces profile in thread milling, four examples are presented in this article. Specific pressure in these examples will be same and are given by $K_f = 900 \text{ N/mm}^2$, $K_n = 500 \text{ N/mm}^2$ and $K_z = 100 \text{ N/mm}^2$.

The tool used in the simulation has the following parameters: $p=1.5 \text{ mm}$, $\lambda = 30^\circ$, $N_f = 4$ and $\xi = 60^\circ$. The geometry of cut and the velocities are: $d_E = 10 \text{ mm}$, $\omega = 1400 \text{ rpm}$, $f_t = 0.06 \text{ mm}$. The values for eccentricity and off set for the run out case are: $\rho = 10^\circ$ and $\epsilon = 0.04 \text{ mm}$.

Example I: In this example the depth of cut is $b = 1.5 \text{ mm}$, just one pitch. To illustrate the example I, Figures (7) presents the chip cross area and the cutting force with and without tool run out.

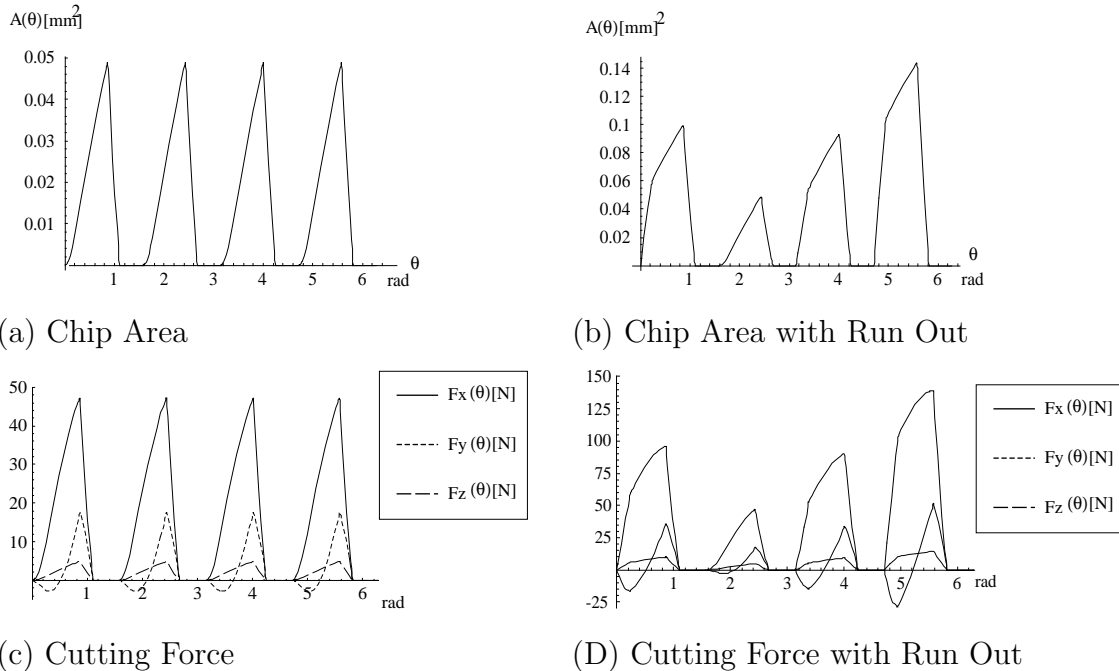

Figure 7 - Example I

Example II: The depth of cut in this example is $b = 5 \text{ mm}$. Figure (8) presents the chip cross area and the cutting force with and without tool run out for this case.

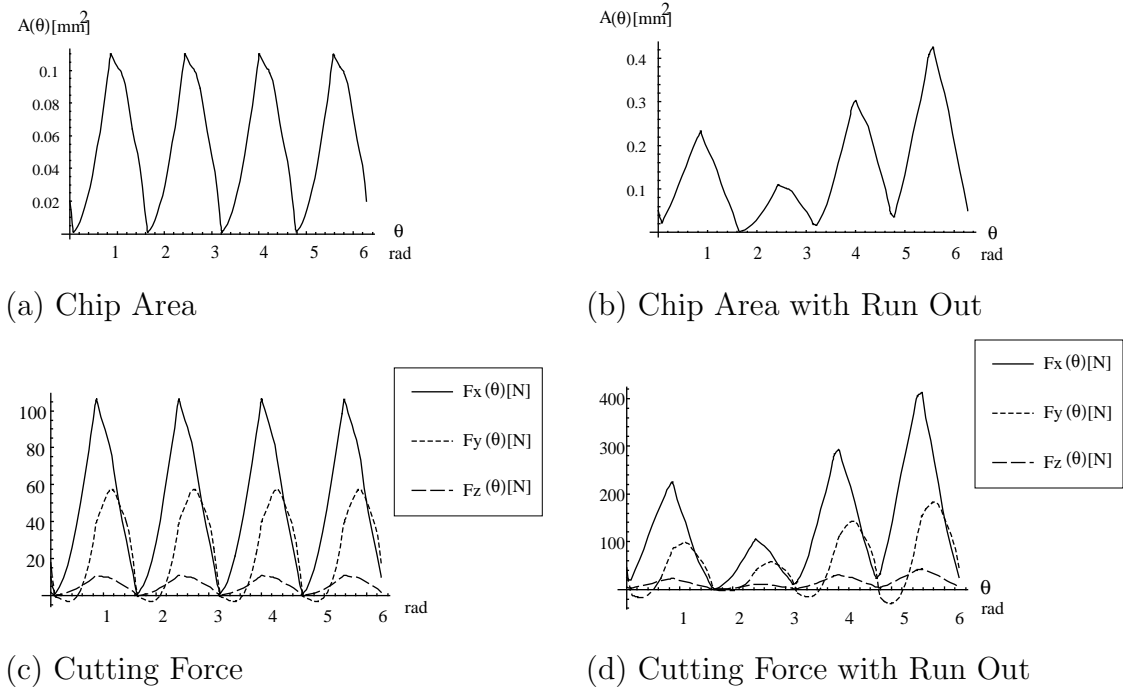

Figure 8 - Example II

Example III: In this example the depth of cut is $b = 10$ mm and Figure (9) presents the chip cross area and the cutting force with and without tool run out for this example.

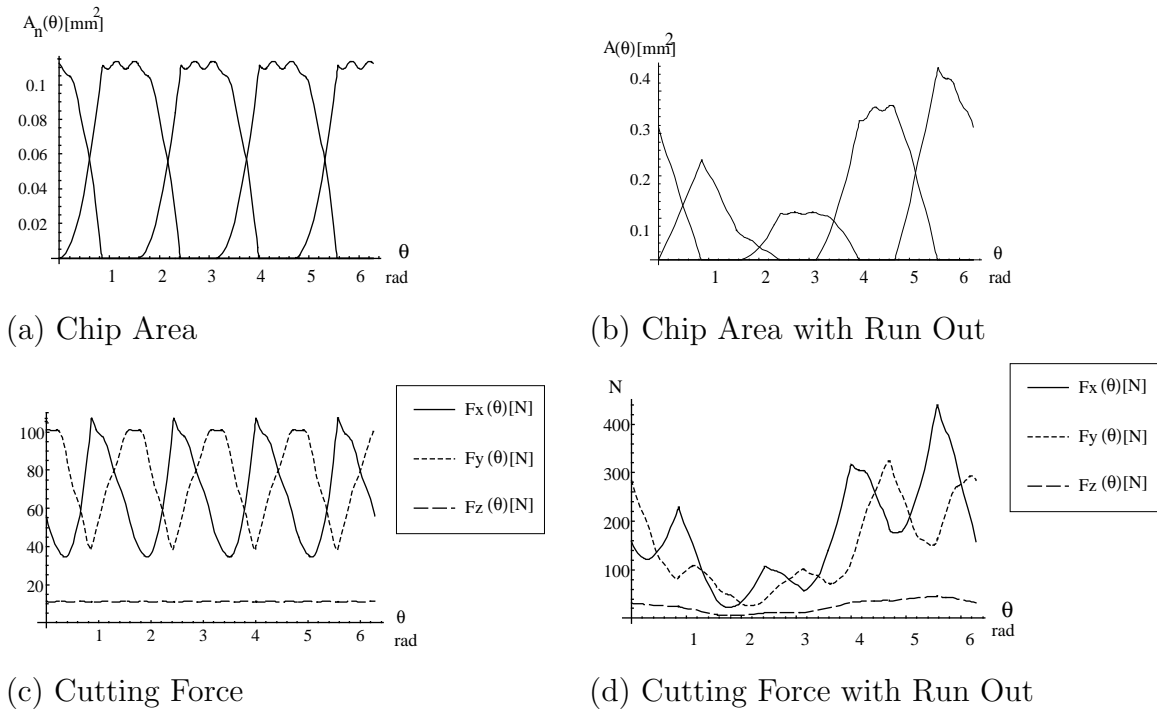
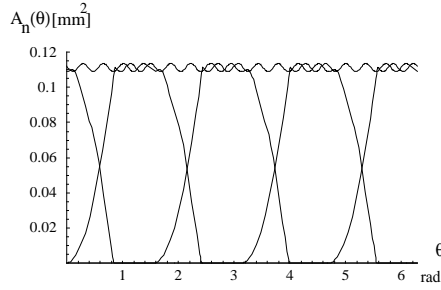
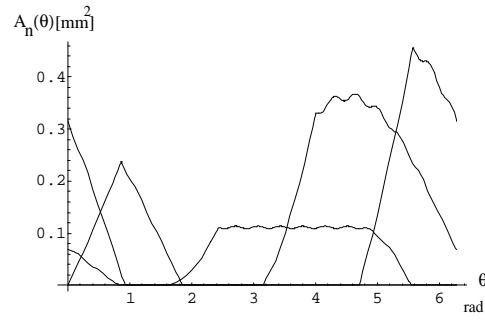

Figure 9 - Example III

Example IV: In example IV the depth of cut is $b = 20$ mm. The chip cross area and the cutting force with and without tool run out for this example are presented in figure (10).



(a) Chip Area



(b) Chip Area with Run Out

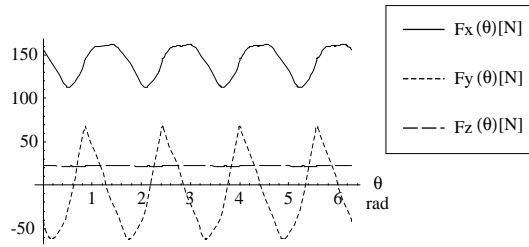

(c) Cutting Force

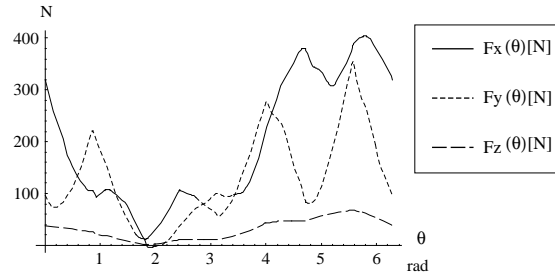

(d) Cutting Force with Run Out

Figure 10 - Example IV

5. CONCLUSIONS

A mechanistic model have been developed for thread milling. The model takes into account the thready cutting edge of the tool and linear movement of the tool. The forces were predicted for four depths of cuts. The results show the effects of the increasing the depth of cut on the cutting forces. The thready flute contribute for another frequency oscillation in chip area and consequently in cutting force as compared to the straight cutting edge. In order to improve the model, the contact stresses between the threads and the tool need to be added.

6. ACKNOWLEDGMENTS

This project is fulfilled with the fellowship received from CNPq, a Brazilian council for scientific and technological development. The author is grateful for the council and the University of Illinois at Urbana Champaign for the support.

6. REFERENCES

- Araujo, A.C., Silveira, J.L., 2001, "The influence of the specific cutting force on end milling models", Proceedings of the 16th Brazilian Congress of Mechanical Engineering, Uberlandia, MG, Brazil.
- Dogra, A.P.S., Kapoor, S.G. and DeVor, R.E., 2002, "Mechanistic Model for Tapping Process with Emphasis on Process Faults and hole geometry", Journal of Manufacturing Science and Engineering, Vol. 124, pp.18-25.
- Ehmann, K.F., Kapoor, S.G., DeVor, R.E. and Lasoglu, I., 1997, "Machining Process Modeling: A Review", J. Man. Sci. Eng., Vol. 119, pp. 655-663.
- Emuge Catalogs, 2002.

- Grahan, Smith, 1989, "Advanced Machining: The handbook of cutting technology", IFS Publications, UK.
- Kline, W.A., DeVor, R.E., 1983, "The effects of run-out on cutting geometry and forces in end milling" Int. J. of Machine Tool Design and Research, Vol. 23, pp.123-140.
- Koelsch, J.R., Oct. 1995, "Thread Milling Takes on Tapping", Manufacturing Engineering.
- Stephenson, D.A. and Agapiou, J.S., 1996, "Metal Cutting Theory and Practice", Marcel Dekker, Inc. New York, NY.
- Sabberwall, 1960, "Chip section and cutting force during the milling operation", Annals of the CIRP, pp. 197-203.
- Thusty, J. and MacNeil, 1975, "Dynamics of cutting in end milling", Annals of the CIRP, Vol. 24/1, pp. 213-221.