



HAL
open science

Techno-Economic Comparison of Total Cost of Ownership of Electric and Diesel Vehicles

Anatole Desreveaux, Eric Hittinger, Alain Bouscayrol, Elodie Castex, Gabriel Mihai Sirbu

► **To cite this version:**

Anatole Desreveaux, Eric Hittinger, Alain Bouscayrol, Elodie Castex, Gabriel Mihai Sirbu. Techno-Economic Comparison of Total Cost of Ownership of Electric and Diesel Vehicles. IEEE Access, 2020, 8, pp.195752-195762. 10.1109/ACCESS.2020.3033500 . hal-03207714

HAL Id: hal-03207714

<https://hal.science/hal-03207714v1>

Submitted on 26 Apr 2021

HAL is a multi-disciplinary open access archive for the deposit and dissemination of scientific research documents, whether they are published or not. The documents may come from teaching and research institutions in France or abroad, or from public or private research centers.

L'archive ouverte pluridisciplinaire **HAL**, est destinée au dépôt et à la diffusion de documents scientifiques de niveau recherche, publiés ou non, émanant des établissements d'enseignement et de recherche français ou étrangers, des laboratoires publics ou privés.



Distributed under a Creative Commons Attribution 4.0 International License

Received October 3, 2020, accepted October 13, 2020, date of publication October 26, 2020, date of current version November 9, 2020.

Digital Object Identifier 10.1109/ACCESS.2020.3033500

Techno-Economic Comparison of Total Cost of Ownership of Electric and Diesel Vehicles

ANATOLE DESREVEAUX¹, ERIC HITTINGER^{1,2}, ALAIN BOUSCAYROL¹, (Member, IEEE),
ELODIE CASTEX³, AND GABRIEL MIHAI SIRBU⁴

¹L2EP, Centrale Lille, Arts et Metiers Institute of Technology, University of Lille, 59000 Lille, France

²Rochester Institute of Technology, Rochester, NY 14623, USA

³Territoires Villes Environnement and Société Laboratory, University of Lille, 59000 Lille, France

⁴Renault Technologie Roumanie SRL, 077190 Bucharest, Romania

Corresponding author: Alain Bouscayrol (alain.bouscayrol@univ-lille.fr)

This work was supported in part by the Framework of the TESS Project of the CUMIN Program of University of Lille from the I-SITE Université de Lille Nord Europe, the Métropole Européenne de Lille, and Region Hauts-de-France, and in part by the Framework of the PANDA Project from the European Union's Horizon 2020 Research and Innovation Program under grant agreement 824256 (PANDA).

ABSTRACT Despite their low environmental impact, electrical vehicles have low penetration in the automotive market. Consumers are reluctant for technical reasons (limited driving range and long charging time) but also for an economic reason (high investment costs). Electric vehicle total cost of ownership (TCO) is often perceived as higher than for a thermal car, especially in Europe where diesel cars have a lower TCO than gasoline cars. Accurate TCO estimations are critical, but most of the techno-economic studies of electrified vehicles are based on very simplified energy models. In this paper, a techno-economic model is developed using an accurate technical model of an electric vehicle and a diesel car of the same segment. These technical models are validated by experimental measurements on real cars using real driving cycles. These models are then coupled to economic models to calculate TCO for a French case study. The total cost of ownership of the studied electric car is lower than for the equivalent diesel car by about 1000€ for a 5-year ownership period. Of particular importance is the finding that using real driving cycles instead of standard driving cycles decreases the TCO of electric cars while simultaneously increasing the TCO of diesel vehicles. This has implications for techno-economic models, suggesting that the typical TCO approach that uses manufacturer-reported standard cycle data may be systemically biased towards thermal vehicles. In order to understand how TCO may change in different locations, a sensitivity analysis varies different technical and economic factors. Government subsidy, ownership duration, and vehicle depreciation are the most important factors for the TCO of electric vehicles. However, TCO of the electric cars can be lower than the TCO of equivalent diesel cars under a wide range of reasonable inputs.

INDEX TERMS Electric vehicle, diesel vehicle, life cycle cost, total cost of ownership, sensitivity analysis.

I. INTRODUCTION

Air pollution and greenhouse gas emissions are important challenges for the transport sector. Electric vehicles (EVs) with zero-emission energy sources have great potential for reducing harmful emissions [1], [2]. According to the International Energy Agency [3], a scenario that limits global warming to 2° C is possible with 150 million EVs on roads by 2030. Efficiency of transport systems are an important parallel effort to reduce pollutant emissions [4].

Many cities around the world expect to replace conventional vehicles by electrified vehicles [5], [6]. For example, 40 cities plan to ban thermal cars by 2030 [5]. However,

The associate editor coordinating the review of this manuscript and approving it for publication was Jesus Felez .

drivers are generally reluctant to adopt electric vehicles due to some technical reasons (limited driving range and long charging time) but mainly for economic reasons (initial purchase costs) [7], [8]. Government subsidies can have a strong effect on EV economics [9], but cost declines and better cost of ownership information also support EV adoption. It is difficult for a consumer to understand the economic viability of EVs in comparison with thermal cars, which is different for each driver. To achieve a high-quality estimation that accounts for a driver's individual situation, an economic model must use technical tools that produce accurate and personalized energy consumption estimates of different vehicles.

Many techno-economic studies of EVs have been completed for different countries and with different time perspectives [10]–[12]. Generally, the economic model is

well developed, but is usually coupled with a simplistic technical model [12]–[15]. For example, a common approach for vehicle energy consumption is to use a fixed kWh/km or l/km, regardless of driving conditions or behavior [16], [17]. However, there are a few exceptions where the technical vehicle model is more sophisticated. In [18], the authors deal with a techno-economic study and a well-to-wheel analysis of electrified vehicles. The vehicle model is realized on the FASTSim software from NREL (US National Renewable Energy Laboratory). The vehicle consumption is calculated using NEDC, a standard driving cycle. In [19], a vehicle simulation tool is used to calculate the energy consumption for different vehicles for a Life Cycle Assessment and an economic study. The vehicle models are not presented, but are calibrated with the NEDC driving cycle. However, [20] shows that the NEDC underestimates the energy consumption of thermal cars. Consequently, that error in the consumption estimation has an impact on any economic calculations. In [21], a technical model of an EV is developed for a well-to-wheel analysis of the vehicle. Then, an economic model is used to compare the energy cost of an EV and a thermal vehicle. However, the technical model of the vehicle traction developed in this study is a static model, not accounting for acceleration. These transient effects are important for high-quality estimation of the energy consumption of a vehicle [22]. Thus, there is a gap in the existing literature, as researchers have not yet brought together a high-quality technical model using realistic driving cycles with an economic model to understand how actual driving cycle patterns affect the total cost of ownership (TCO).

The objective of this paper is to propose a more realistic TCO comparison between an electric vehicle and a diesel car of the same segment. Towards that goal, two accurate technical models will be used for a more precise estimation of driving consumption. These accurate vehicle models have been developed for a first comparison of the pollutant emissions of both vehicles [23]. Because no experimental validation of these technical models was performed, this work improves the prior research with a model update and a comparison using driving tests of real vehicles. These verified technical models are then coupled with an economic model, which evaluates the TCO of vehicle operations [17].

The contribution of the paper is to link accurate and validated vehicle models using a real driving cycle with detailed economic models to improve total cost of ownership estimates. This new capability allows comparison between the standard driving cycles (ex. WLTC) that have historically been used in techno-economic analysis with actual driving cycles. It also allows direct comparison between technical and economic features (such as between driving style and interest rate on vehicle loan).

In order to give real-life results, actual driving cycles from commuters at our university are considered instead of classical driving cycles. This first step produces a base case that allows for sensitivity analysis with different technical and

economic inputs, which can represent the scenarios in other locations.

Section II presents the technical model for both vehicles, which are validated with real measurements. In section III, the economic model is established. Section IV presents the techno-economic comparison based on real commuting trips. Finally, the impact of the accurate technical models and real trips on the techno-economic metrics are discussed under different scenarios.

II. TECHNICAL MODEL OF THE VEHICLES

The simulation tools of diesel and electric vehicles are developed respectively in part A and B. In part C, the energy consumption of both vehicles is compared with standard consumption estimation approaches found in literature. This comparison shows the importance of using accurate technical models instead of standard fixed values. In part IV, the two models are used in an economic model to produce the techno-economic results that account for more accurate energy consumption estimates.



FIGURE 1. Renault Clio used for validation tests.

A. SIMULATION OF THE DIESEL VEHICLE

1) MODELING OF THE DIESEL VEHICLE

The diesel vehicle is based on a Renault Clio (Figure 1) [24]. The parameters of the vehicle are given by Table 1.

TABLE 1. Critical parameters of the Renault Clio.

Elements	Characteristics
Engine	Diesel 1.5 dci 51 kW
Weight	1185 kg

The Internal Combustion Engine (ICE) is connected to the wheels through a manual gearbox and a differential.

A classical consumption map is used to model the engine fuel consumption as a function of the engine torque and its rotation speed (Figure 2).

The gearbox torque T_{gb} is given as a function of the engine torque T_{ice} , the gearbox ratio k_{gb} , and the efficiency η_{gb} . The last two variables can change as a function of the 5 gears of the manual gearbox (Table 2). At each step, the gear ratio is chosen as a function of the velocity of the vehicle. The speed

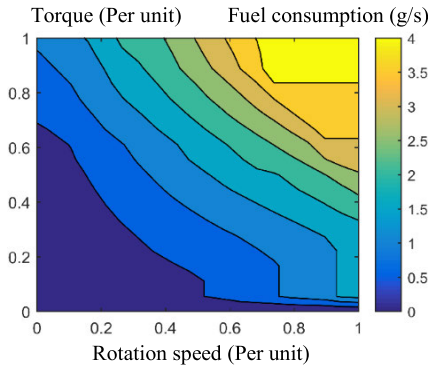

FIGURE 2. Consumption map of the diesel engine.

TABLE 2. Gear ratio for the gearbox of the diesel vehicle.

Gear	1	2	3	4	5
Gear ratio	3.73	1.95	1.37	1	0.76

of the gearbox Ω_{gb} depends on the wheel speed Ω_{wh} and the gearbox ratio:

$$\begin{cases} T_{gb} = k_{gb} T_{ice} \eta_{gb}^{k_g} \\ \Omega_{gb} = k_{gb} \Omega_{wh} \end{cases} \quad \text{with } k_g = \begin{cases} 1 & \text{if } T_{gb} \Omega_{wh} \geq 0 \\ -1 & \text{if } T_{gb} \Omega_{wh} < 0 \end{cases} \quad (1)$$

The wheels are considered as an equivalent wheel. The wheel force F_{wh} is calculated as a function of the gearbox torque T_{gb} , the wheel radius R_{wh} , and the differential ratio k_{diff} :

$$\begin{cases} F_{wh} = \frac{k_{diff} T_{gb}}{R_{wh}} \\ \Omega_{wh} = \frac{k_{diff} v_{dv}}{R_{wh}} \end{cases} \quad (2)$$

The total force F_{tot} depends on the wheel force F_{wh} and the braking force F_{br} :

$$F_{tot} = F_{wh} + F_{br} \quad (3)$$

Newton's second law gives the vehicle velocity v_{dv} as a function of the total force F_{tot} , the resistive force F_{res} , and the mass of the vehicle M_{veh} :

$$M_{veh} \frac{dv_{dv}}{dt} = F_{tot} - F_{res} \quad (4)$$

The resistive force F_{res} is composed of the road resistance F_{road} , the aerodynamic resistance F_{aero} , and the slope resistance F_{slope} :

$$F_{res} = F_{road} + F_{aero} + F_{slope} \quad (5)$$

2) ORGANIZATION OF THE MODEL

The model of the diesel vehicle is described using Energetic Macroscopic Representation (EMR) [26]. EMR is a graphical formalism that organizes different models of multi-physical systems. Moreover, a control loop can be deduced directly from the EMR by inverting each element.

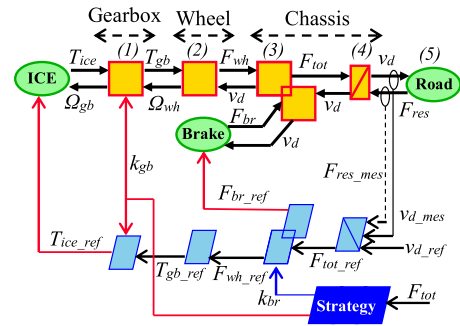

FIGURE 3. EMR of the diesel vehicle.

The EMR of the diesel vehicle (Figure 3) is composed of a mechanical source represented by the ICE (green oval), two conversion elements for the gearbox and the wheel (orange squares), a coupling element to couple the brake and the wheel (double orange square), an accumulation element for the chassis (crossed orange rectangle), and a mechanical source for the road. All modelling equations are integrated in the pictograms.

The control scheme is deduced from the EMR. The accumulation elements need a closed-loop control of the velocity of the vehicle (light blue crossed parallelogram). The other elements are directly inverted. A strategy level gives the gearbox ratio as a function of the car velocity to optimize the fuel consumption. Moreover, this strategy allows the decoupling of the mechanical brake from the propulsion part of the model.

3) VALIDATION

A real extra-urban trip was recorded with the diesel vehicle. The trip was 21 km long for a duration of 26 min in a city. The velocity profile (Figure 4 a) and the fuel consumption were measured. The velocity is measured with a GPS and depends on the speed limitations and the traffic conditions during the car trip. The consumption is measured on the CAN Bus of the vehicle with an OBD dongle.

The simulation of the vehicle is realized with Matlab/Simulink© software based on the EMR organization. The measured velocity is provided as a simulation input. The instantaneous fuel consumption is calculated in the vehicle simulation (Figure 4 b). This fuel consumption is then integrated to obtain the cumulative fuel consumption (Figure 4 c.). The cumulative fuel consumption measured during the driving test is also plotted in the same figure. In order to have a more general comparison, the final consumption is reported in l/100 km. The consumption of the measured real trip is 4.88 l/100 km. The fuel consumption of the simulation is 4.91 l/100 km. That leads to an error of about 1%.

B. SIMULATION OF THE ELECTRIC VEHICLE

1) MODELING OF THE ELECTRIC VEHICLE

The electric vehicle is the Renault Zoe (Figure 5) [27]. It is in the same size segment as the diesel vehicle and comes

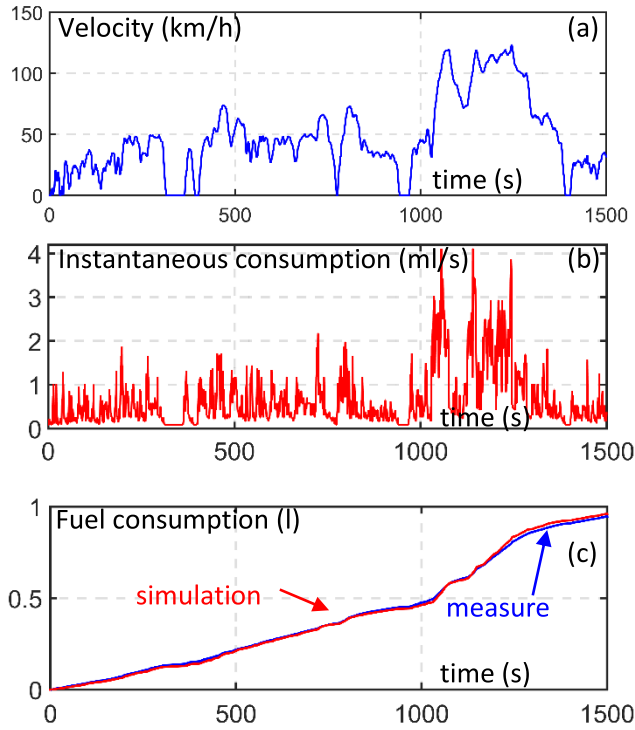

FIGURE 4. a) Measured velocity profile for the diesel vehicle b) Instantaneous fuel consumption of the ICE c) Comparison of the measured and simulated cumulative fuel consumption.



FIGURE 5. Renault Zoe used for validation test.

TABLE 3. Critical parameters of the Renault Zoe.

Elements	Characteristics
Battery	Li-ion NMC-41 kWh
Electric Machine	Synchronous machine 65 kW
Weight	1480 kg

from the same manufacturer. The parameters of the vehicle are given by Table 3.

The vehicle is composed of a battery, an electric drive, a gearbox, a differential, and the wheels.

The battery voltage u_{bat} is a function of the Open Circuit Voltage (OCV) u_O , the resistance of the battery, and the current i_{bat} . The OCV depends on the State of Charge (SoC) relative to the current.

$$u_{bat} = u_O (SoC) - R_{bat}i_{bat} \quad (6)$$

The electric drive is modeled with a static model that has a constant efficiency $\eta_{ed} = 87\%$, considered sufficient for such a study [22].

$$\begin{cases} T_{ed} = T_{ed_ref} \\ i_{bat} = \frac{T_{ed}\Omega_{gb}\eta_{ed}^{k_{ed}}}{u_{bat}} \end{cases} \text{ with } k_{ed} = \begin{cases} 1 & \text{if } T_{ed}\Omega_{gb} < 0 \\ -1 & \text{if } T_{ed}\Omega_{gb} \geq 0 \end{cases} \quad (7)$$

The gearbox is a fixed-gear gearbox with a constant efficiency $\eta_{gb} = 95\%$.

$$\begin{cases} T_{gb} = k_{gb}T_{ed}\eta_{gb}^{k_g} \\ \Omega_{gb} = k_{gb}\Omega_{wh} \end{cases} \text{ with } k_g = \begin{cases} 1 & \text{if } T_{gb}\Omega_{wh} \geq 0 \\ -1 & \text{if } T_{gb}\Omega_{wh} < 0 \end{cases} \quad (8)$$

The equations for the wheel and the chassis are the same as the diesel vehicle.

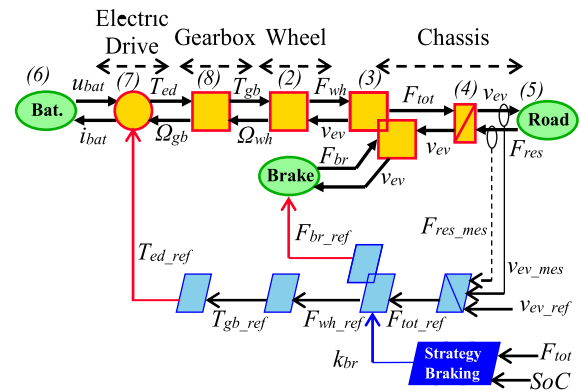

FIGURE 6. EMR of the electric vehicle.

2) ORGANIZATION OF THE MODEL

The model of the EV is organized with EMR. The EMR of the EV (Figure 6) is composed as follows: the battery as a power source (green oval), the electric drive as a multi-domain conversion element (orange circle), a gearbox and wheels as mono-domain conversion elements (orange squares), the coupling of mechanical brakes with the wheels as coupling elements (overlapped orange squares) and the chassis as an accumulation element (crossed orange rectangle) for the velocity of the vehicle, and a source for the road.

The control scheme of the EV is similar to that of the diesel vehicle (blue parallelograms) deduced directly from the EMR.

A strategy element manages the use of the electric brake and the mechanical brake as a function of the total force imposed by the vehicle and the SoC of the battery. In this case, energy recovery is possible during the braking phases thanks to the reversible electrical machine.

3) VALIDATION

The Renault Zoe was driven on an extra-urban trip (Figure 7 a) of 21 km and a duration of 27 min. The velocity profile is measured with a GPS and the energy consumption is measured on the vehicle CAN Bus with an OBD dongle.

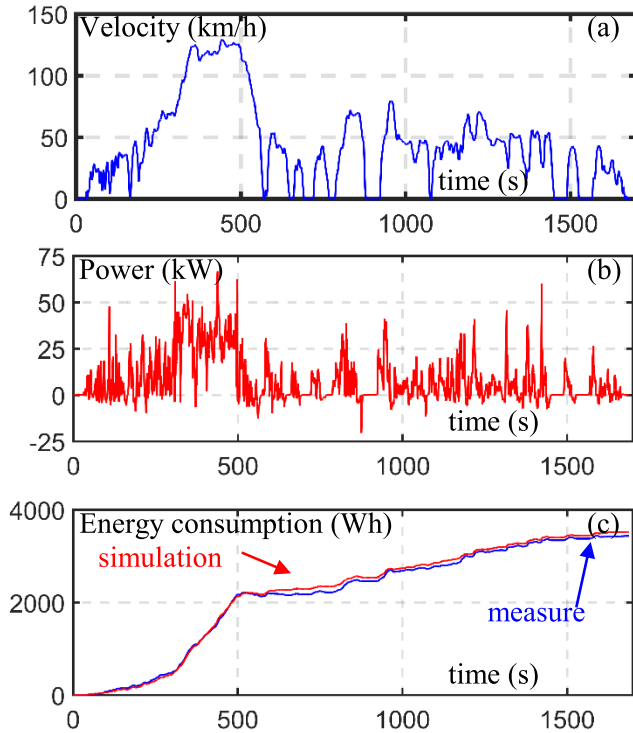

FIGURE 7. a) Measured velocity profile for the evaluation of the EV b) Simulated battery power c) comparison of the simulated and measured cumulative energy consumption of the EV.

The power at the input of the battery is calculated by the simulation (Figure 7 b). This power is integrated to find the energy consumption of the vehicle and compared with the measured energy consumption (Figure 7 c). The final simulated energy consumption is 3.53 kWh. The final measured consumption from the vehicle is 3.45 kWh. That leads to an error of about 2%.

C. COMPARISON WITH STANDARD CONSUMPTION VALUES

The energy consumption of the two vehicles calculated by the developed models are compared with a “constant consumption” approach based on manufacturer-reported values for the same vehicles. These constant values are used for the TCO calculation in [15] and [28].

1) ELECTRIC VEHICLE

The “constant consumption” value is 20 kWh/100 km. The energy consumption of the real extra-urban trip (Figure 7) is 20% lower than the constant consumption value for the EV (Table 4). In [15] and [28], the authors used the manufacturer-reported NEDC energy consumption value with a corrective factor of 45% which would lead to overestimation of the costs of the EV.

2) DIESEL VEHICLE

For the diesel vehicle, the “constant consumption” value is 3.8 L/100km [28] based on the manufacturer-reported

TABLE 4. Comparison of the energy consumption for an EV.

	Real	Constant
Consumption (kWh/100 km)	16.6	20.1

NEDC consumption. The fuel consumption based on the extra-urban trip measured with the vehicle (Figure 4 a) can be compared to this fixed value for the diesel vehicle. In this case, the relationship is reversed: the constant consumption value underestimates energy use by ~20%, which leads to underestimation of the fuel consumption and costs of the diesel vehicle (Table 5).

TABLE 5. Comparison of the energy consumption for a diesel vehicle.

	Real	Constant
Consumption (l/100 km)	4.9	3.8

3) COMPARISON DEVIATION

From these results, it should be clear that the classical techno-economical approach leads to an important misestimation. The energy consumption is overestimated for the EV and underestimated for the diesel car. This deviation will thus have an impact on the TCO estimates, biasing the results towards diesel vehicles. A more accurate technical model is thus important.

III. ECONOMIC MODEL

The economic model is developed for a vehicle purchased in France in 2020 and calculates the total cost of ownership (TCO) using a standard Net Present Value (NPV) method. The economic model takes into account the cost of the Electric Vehicle and the Diesel Vehicle, the tax policy, the salvage/resale values of the vehicles at the end of the ownership, and the energy costs. The replacement of the battery and its lifetime is not considered as newer batteries now have lifetimes approximately equal to the expected life of the vehicle [29].

The capital cost of the vehicles (CC) depends on the initial cost of the vehicle C_{veh} , the cost of the green card (registration) C_{gc} , and a tax policy P_{veh} in favor of the vehicle (or disfavor in the case of the diesel):

$$CC = C_{veh} + C_{gc} - P_{veh} \tag{9}$$

The Salvage Value SV is the resale value of a vehicle at the end of its ownership. We follow the method described in [17] where resale value depends on the initial cost of the vehicle C_{veh} , the tax policy P_{veh} , and the depreciation rate A_{dep} , and is discounted to present value using the discount rate σ and the number of years before resale n (10). The depreciation rate follows a decelerating decline, calibrated based on actual resale values of US vehicles [30]. We assume that the percentage change in value over time for a vehicle in France follows the same empirical trend as the US. Moreover we assume that the same model can be used for both types

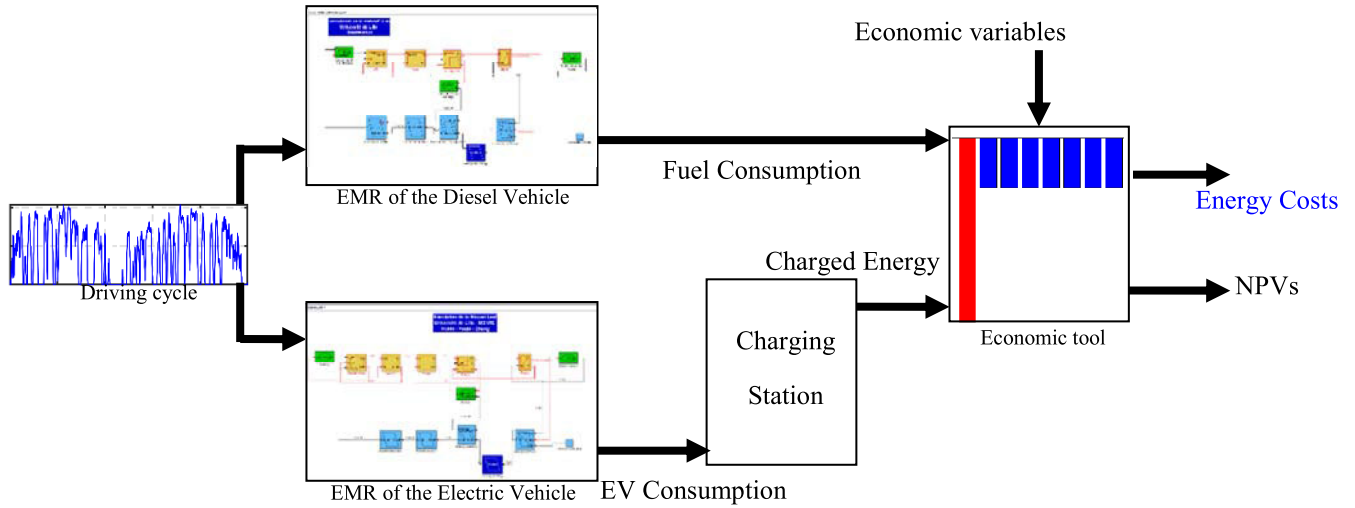

FIGURE 8. Techno-economic model coupling for the study.

of vehicles. While new technologies generally do not have the same salvage value as mature technologies, we consider that EVs will become a more mature and accepted technology in the coming years. However a sensitivity analysis will study the impact of this factor in section IV.F.

$$SV = (1 - A_{dep}) (C_{veh} - P_{veh})(1 + \sigma)^{-n} \quad (10)$$

$$\text{With } A_{dep} = 6 \times 10^{-5} n^3 - 0.0038 n^2 + 0.093 n + 0.1384 \quad (11)$$

The energy cost of the Electric Vehicle EC_{EV} is a function of the vehicle annual mileage D_{veh} , the annual amount of charging energy needed by the vehicle E_{ev} , and the cost of electricity C_{elec} :

$$EC_{EV} = E_{EV} D_{veh} C_{elec} \quad (12)$$

The energy cost of the diesel vehicle EC_{DV} depends on the fuel consumption of the diesel vehicle E_{DV} , the diesel cost C_D and the annual mileage of the vehicle D_{veh} :

$$EC_{DV} = E_{DV} D_{veh} C_D \quad (13)$$

The energy cost for each vehicle EC is added to the maintenance cost C_m and the insurance cost C_{ins} to obtain the annual cost for the different vehicles AC :

$$AC = EC + C_m + C_{ins} \quad (14)$$

The total cost of ownership (TCO) depends on the capital cost, the salvage value and the annual cost of the vehicle:

$$TCO = CC - SV + \sum_{i=0}^n \frac{AC}{(1 + \sigma)^i} \quad (15)$$

IV. ECONOMIC COMPARISON UNDER DIFFERENT SCENARIOS

In this part, the techno-economic model is brought together to analyze the total cost of ownership of vehicles. The techno-economic study is presented first as the link between

the technical models and the economic model. Then, the study is applied to 3 different real driving cycles: an urban, an extra-urban and a highway trip.

The real driving cycles represent a case study at the University of Lille, as part of the CUMIN program. The CUMIN (Campus of University with Mobility based on Innovation and carbon Neutrality) program [31] is focused on reducing greenhouse gas emission from thermal vehicles that come to campus. One strategy of this program is to replace thermal cars with electric vehicles. In this transition, economic tools are necessary to plan for charging stations and photovoltaic panels to provide electricity for EVs.

Commuting trips to the University of Lille are analyzed in detail to guide the selection of vehicles for campus commuters. These driving cycles represent the diversity of expected road conditions and energy consumption. The three driving cycles are compared with the standard case (WLTC) used in recent techno-economic studies. Finally, a sensitivity analysis is conducted to compare the effect of different technical and economic parameters.

A. TECHNO-ECONOMIC STUDY

A driving cycle is an input of the technical models, used to calculate the energy consumption of the vehicles. For the diesel vehicle, the fuel consumption is directly connected to the economic model. For the Electric Vehicle, the charging infrastructure efficiency is also required to estimate the true energy used to charge the vehicle and purchased by the EV owner. The charging infrastructure is considered to have an efficiency of 87% [32]. Only slow charging is considered in this study. For both vehicle types, the calculated energy consumption is an input of the economic model (Figure 8).

Other inputs of the economic model are the mileage of the vehicle, the interest rate of the vehicle loan, the electricity price, the diesel price, and the maintenance and the insurance of the vehicle. These variables are summed up in

TABLE 6. Base case parameters of the techno-economic study and ranges used in sensitivity analysis.

Parameters	Values	Range
Diesel (€/l) [36]	1.44	1 - 1.85
Electricity off-peak hour (€/kWh) [36]	0.132	0.095 – 0.171
DV maintenance (€) [37]	592	
EV maintenance (€) [37]	500	
DV insurance (€) [37]	500	
EV insurance (€) [37]	400	
EV bonus [34]	8 000	5 000 – 11 000
Interest rate (%) [38]	4.05%	3.57 – 5.17
Mileage (km) [39]	9 500	5000 – 14000

TABLE 6 with their values in 2020. Base case numbers are the most current values available, while the range is based on historical variation in the variable over the last 10 years, except for the interest rate, where it is 5 years. The economic calculations give the energy cost and the TCO for the different vehicles.

The vehicle prices are the prices in 2020. The EV can be considered with two options: one has battery leasing, the second is the electric vehicle purchased with its battery. In leasing, the vehicle is sold at 23 900€, versus 32 000€ for the complete vehicle. The leasing cost of the battery depends on the mileage and the lifetime of the vehicle and is between 530€ and 1 490€ per year. The diesel vehicle is sold at 19 300€ and has no tax policy. The Electric Vehicle is considered to have a tax bonus of 8 000€ in the base case. While the actual subsidy is higher than 8 000€ in France [34] or Norway [34], it represents a typical subsidy level given by most European countries [33].

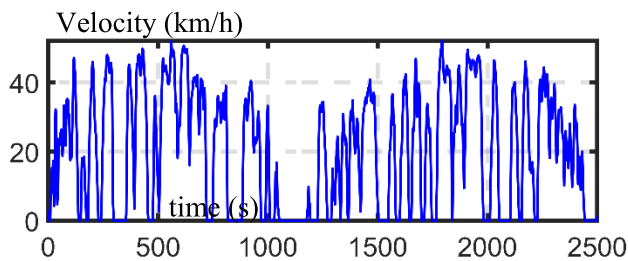

FIGURE 9. Urban driving cycle.

B. COMPARISON OF DIESEL AND EV VEHICLES FOR AN URBAN DRIVING CYCLE

The first considered trip is a real measured urban trip with a lot of stops due to traffic lights and traffic conditions (Figure 9). The trip length is 14 km. The duration is 40 min.

The consumption is calculated for the two vehicles with the two technical models. The fuel consumption for the diesel vehicle is 5.48 l/100 km. The EV has an energy consumption of 14.16 kWh/100 km. These energy consumption estimates are scaled up for the two vehicles and used to estimate annual energy costs by assuming that the vehicle is driven 9 500 km per year on this route. The energy cost for the diesel vehicle is 754€ per year against 204€ per year for the EV. That leads to a reduction of 73% in the energy cost when switching to an EV under the urban driving cycle.

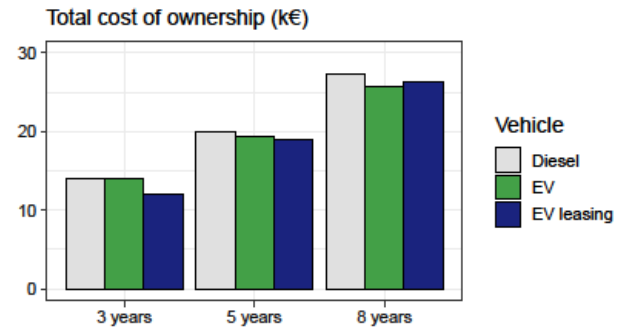

FIGURE 10. TCO of vehicles for the urban case, for the diesel car and electric vehicles with and without the battery leasing.

The total cost of ownership (TCO) for the EV with and without the leasing of the battery and the diesel vehicle are compared (Figure 10). In each case, the EV has a TCO equal to or lower than the diesel vehicle. The EV saves between 72€ and 1952€. Between the 2 EV options, the leasing of the battery is preferred for shorter ownership duration of the vehicle. But in the long-term, it is better to buy the full EV with the battery included. This is generally expected: leasing terms are normally most favorable for shorter-term ownership of assets.

C. COMPARISON OF DIESEL AND ELECTRIC VEHICLES FOR AN EXTRA-URBAN DRIVING CYCLE

The extra-urban case was used for the validation of the EV (see Figure 7) and is also used as a scenario here. The simulation of the diesel vehicle gives a consumption of 4.72 l/100 km. The EV has a consumption of 16.64 kWh/100 km. Using this as the standard driving cycle over the year gives an energy cost of 650€ for the diesel. The EV has an energy cost of 240€, representing a reduction of 63%.

In this case, the TCO of the electric vehicle is not consistently dominating the diesel (Figure 13). The difference goes from -317€ to 1563€ of savings on the total cost of ownership for EVs. As in the urban case, the leasing of the battery is preferred in the first 5 years but not at 8 years or more.

D. COMPARISON OF DIESEL AND EV VEHICLES FOR A HIGHWAY DRIVING CYCLE

The last case is a real, measured highway-heavy trip (Figure 14). The trip has a higher average velocity and fewer

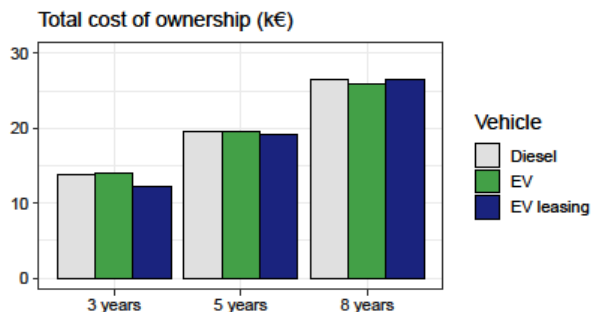

FIGURE 11. TCO for the extra-urban case, for diesel vehicle and electric vehicles with and without the battery leasing.

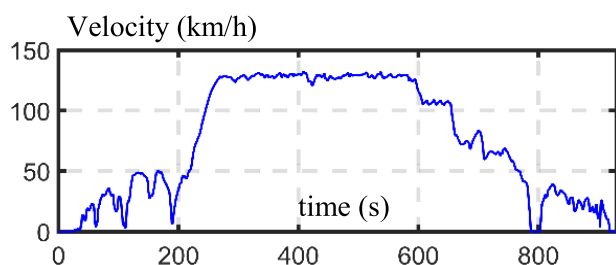

FIGURE 12. Highway driving cycle.

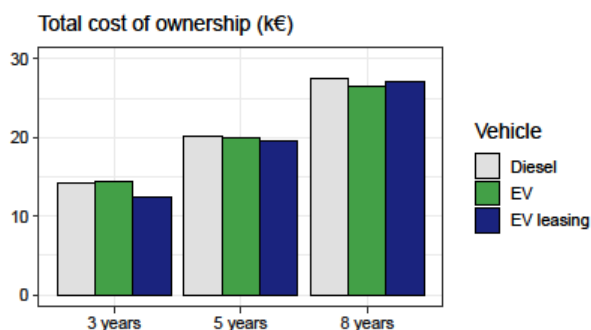

FIGURE 13. TCO for the highway driving cycle, for the diesel vehicle and electric vehicles with and without the battery leasing.

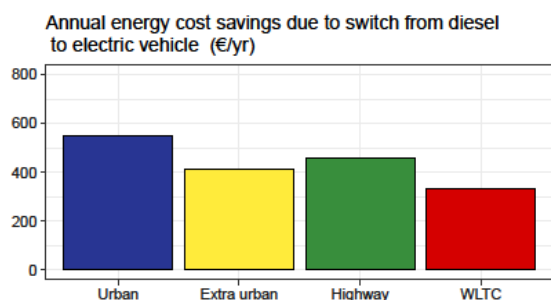

FIGURE 14. Annual energy costs savings achieved by switching from the diesel to the electric vehicle under four driving cycles.

accelerations than the previous driving cycles. The trip length is 19.5 km for a duration of 16 min.

The diesel vehicle has a fuel consumption of 5.73 l/100 km. The energy consumption is 22.9 kWh/100 km for the EV. The annualized energy cost for the diesel vehicle, assuming that

this driving cycle represents driving patterns over the year, is 789€. The EV has an energy cost of 330€, saving 58%. The TCO for the vehicles are presented in Figure 13. Except for the full EV with resale at 3 years, the EV has a lower TCO than the diesel vehicle. Despite having a lower percentage decrease in the annual energy cost than the Extra-urban driving cycle (58% vs. 63%), this cycle has more favorable economics for the EVs because the absolute difference in annual fuel costs is larger (459€ versus 410€). The leasing of the battery is preferred for 3- or 5-year lifetime but not for 8-years of ownership.

E. COMPARISON BETWEEN DIFFERENT DRIVING CYCLES

In this part, the results of the different cases are summarized and a comparison with the classical approach is provided. For the classical approach, the consumption of the two vehicles is taken from the manufacturer [24], [27]. This consumption is calculated with the WLTC and represents a more traditional (and simple) method for calculating the total cost of ownership of vehicles.

The difference in annual energy costs is given by Figure 14. The largest savings for the EV in terms of energy spending is for the urban cycle (550€ less than the energy cost for the diesel car). The difference is 410€ for the extra urban trip and 459€ for the highway trip. Using the information provided by a standard WLTC produces the smallest savings for the EV, at 330€ per year. This standard classical driving cycle thus underestimates the annual savings of an EV relative to any of the three measured driving cycles. However, this standard driving cycle is used, directly or indirectly through manufacturer-reported data, in essentially all techno-economic comparisons of thermal and electric vehicles [20].

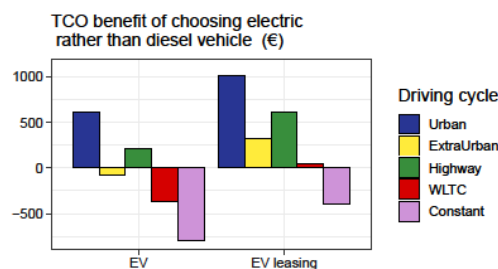

FIGURE 15. TCO benefit of selecting an electric rather than a diesel vehicle, under five driving cycle scenarios.

The Difference in TCO between EVs and diesel vehicle are given in Figure 15 for an ownership period of 5 years. In order to show the importance of the accurate technical models, TCO values calculated using a traditional techno-economic approach are also plotted. This includes the TCO using a WLTC (rather than a real driving cycle) and a TCO calculated using the “constant consumption” value reported by the manufacturer (see section II.C). Both the WLTC-based information from the manufacturer and the constant consumption data are more favorable to diesel than any of the real driving cycles. Relative to a diesel vehicle, the real driving cycles

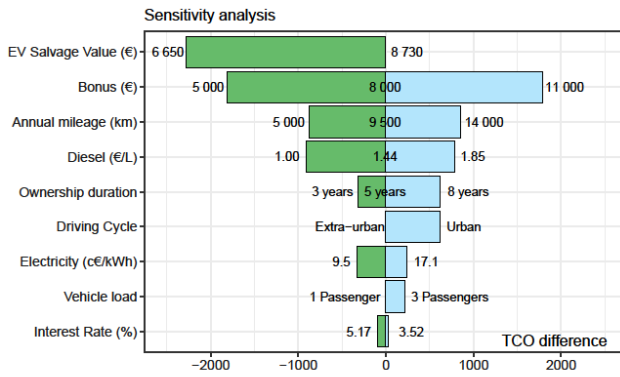

FIGURE 16. Sensitivity analysis.

suggest that EVs are consistently preferred in terms of TCO. While further study is justified, this suggests that the existing economic literature may have a small but consistent bias against EVs because of the commonly used methods.

F. SENSITIVITY ANALYSIS

A sensitivity analysis is performed to compare the effects of technical variables with economic variables. This also permits consideration of other scenarios and locations than the study case.

The base case and the ranges are given in TABLE 6. The base case driving cycle is the extra-urban cycle and the base case vehicle carries only the driver. For variation in technical parameters, we change the driving cycle for the vehicle or increase the average number of passengers to three. For economic variation, we use historical variation in the data collected (references in TABLE 6) to get plausible ranges for the variables: electricity and diesel prices in [36], the mileage in [39] and the interest rate in [38]. The bonus (government subsidy) can change quickly, and we apply a variation in either direction of 40%. A more regressive salvage value is also considered for the EV. Equation (16) gives a faster depreciation rate of the salvage value compared to (11).

$$A_{dep} = -58 \times 10^{-10} n^5 + 10^{-7} n^4 + 1,98 \times 10^{-4} n^3 - 0.0087 n^2 + 0.137 n + 0.1384 \quad (16)$$

The Total cost of ownership (TCO) is calculated for both the diesel and the electric vehicle. The difference between the TCO for the diesel vehicle and the EV are calculated for each case (Figure 16). In the base case, the difference is -10€ , meaning that the TCO of the EV is essentially equal to the TCO of the diesel vehicle.

The higher (light blue) and lower (dark green) cases are represented for each variable by a bar beginning at the base case. The variables are sorted by the magnitude of the effect on TCO difference. Over the ranges selected, a faster vehicle depreciation rate for resale of the electric vehicle has the largest effect on TCO. However, this depreciation rate will likely slow down as EVs sales increase. The EV Bonus has the second-largest effect. A reduction of the EV bonus by

3 000€ leads to a difference of 1800€ (due to the depreciation of the EV) in favor of the diesel vehicle. The next is the mileage, where an increase of 4500 km increases the TCO difference by 860€. Increasing the diesel price by 28% (consistent with historical fluctuations) increases the TCO difference by 800€. The duration of ownership has a moderate impact. A highway driving cycle or an urban trip instead of the extra-urban cycle increases the difference respectively by 220€ and 620€. The increase of the electricity price by 30% decreases the TCO difference by 320€. Adding two passengers into the cars increases the total cost of ownership benefit of an EV by 210€. The interest rate is the last variable and has the smallest impact on the TCO of the vehicle because of the short lifetimes of vehicle loan payments and the historically consistent loan rates. Increasing the loan interest rate from 4.05% to 5.17% decreases the TCO difference by 40€.

V. CONCLUSION

This work has developed a techno-economic analysis of the total cost of ownership of electric and diesel vehicles and applied it to a case study in France. The focus of the work is to bring together technical and economic models that can capture and compare the relevant factors from both domains. The technical model has been validated with real measurements and is able to provide accurate energy consumption for the two vehicles studied. This has been coupled with an economic model to assess the energy cost and total cost of ownership for the vehicles under a variety of scenarios. An accurate consumption can thus be calculated for any driving cycle and used in an economic estimation of the total cost of ownership.

The results illustrate a TCO advantage for EVs in France that is dependent on the currently favorable tax bonus but is otherwise relatively robust. In general, the economic variables have a stronger effect on TCO than the technical variables. The depreciation rate and governmental incentives are the main factors for the TCO of EVs. Importantly, this work highlights a general issue with standard driving cycles, which consistently underestimate the benefits of EVs for the three measured driving cycles we used.

There is potential to apply or extend this research in several directions. For an economic study of a dedicated area, we can offer precise estimations to commuters about the cost of ownership of their vehicle options and calculate the amount of charging infrastructure needed to charge a fleet of EVs. The analysis can be extended to other vehicle segments and technologies and the effect of climate conditions and driver behavior on the TCO can be assessed.

REFERENCES

- [1] J. Van Mierlo, M. Messagie, and S. Rangaraju, "Comparative environmental assessment of alternative fueled vehicles using a life cycle assessment," *Transp. Res. Procedia*, vol. 25, pp. 3439–3449, Jan. 2017.
- [2] X. Mou, Y. Zhang, J. Jiang, and H. Sun, "Achieving low carbon emission for dynamically charging electric vehicles through renewable energy integration," *IEEE Access*, vol. 7, pp. 118876–118888, 2019.
- [3] *Global EV Outlook 2018, Towards Cross-Modal Electrification*, International Energy Agency Report, Paris, France, 2018.

- [4] S. Saponara, C. H. T. Lee, N. X. Wang, and J. L. Kirtley, "Electric drives and power chargers: Recent solutions to improve performance and energy efficiency for hybrid and fully electric vehicles," *IEEE Veh. Technol. Mag.*, vol. 15, no. 1, pp. 73–83, Mar. 2020.
- [5] C40 Cities Organization. *Fossil Fuel Free Streets Declaration*. Accessed: Jul. 6, 2020. [Online]. Available: <https://www.c40.org/other/green-and-healthy-streets>
- [6] Bloomberg. *A Dead End for Fossil Fuel in Europe's City Centers*. Accessed: Jul. 6, 2020. [Online]. Available: <https://www.bloomberg.com/news/articles/2019-07-26/a-dead-end-for-fossil-fuel-in-europe-s-city-centers>
- [7] B. Junquera, B. Moreno, and R. Álvarez, "Analyzing consumer attitudes towards electric vehicle purchasing intentions in Spain: Technological limitations and vehicle confidence," *Technol. Forecasting Social Change*, vol. 109, pp. 6–14, Aug. 2016.
- [8] S. Habib, M. M. Khan, F. Abbas, L. Sang, M. U. Shahid, and H. Tang, "A comprehensive study of implemented international standards, technical challenges, impacts and prospects for electric vehicles," *IEEE Access*, vol. 6, pp. 13866–13890, 2018.
- [9] S. Yan, "The economic and environmental impacts of tax incentives for battery electric vehicles in Europe," *Energy Policy*, vol. 123, pp. 53–63, Dec. 2018.
- [10] R. Faria, P. Moura, J. Delgado, and A. T. de Almeida, "A sustainability assessment of electric vehicles as a personal mobility system," *Energy Convers. Manage.*, vol. 61, pp. 19–30, Sep. 2012.
- [11] X. He, S. Zhang, Y. Wu, T. J. Wallington, X. Lu, M. A. Tamor, M. B. McElroy, K. M. Zhang, C. P. Nielsen, and J. Hao, "Economic and climate benefits of electric vehicles in China, the United States, and Germany," *Environ. Sci. Technol.*, vol. 53, no. 18, pp. 11013–11022, Aug. 2019.
- [12] A. E. P. Abas, J. Yong, T. M. I. Mahlia, and M. A. Hannan, "Techno-economic analysis and environmental impact of electric vehicle," *IEEE Access*, vol. 7, pp. 98565–98578, 2019.
- [13] C. Guo and C. C. Chan, "Analysis method and utilization mechanism of the overall value of EV charging," *Energy Convers. Manage.*, vol. 89, pp. 420–426, Jan. 2015.
- [14] H. Hao, M. Wang, Y. Zhou, H. Wang, and M. Ouyang, "Levelized costs of conventional and battery electric vehicles in China: Beijing experiences," *Mitigation Adaptation Strategies Global Change*, vol. 20, no. 7, pp. 1229–1246, Oct. 2015.
- [15] P. Letmathe and M. Soares, "A consumer-oriented total cost of ownership model for different vehicle types in Germany," *Transp. Res. D, Transp. Environ.*, vol. 57, pp. 314–335, Dec. 2017.
- [16] Q. De Clerck, T. van Lier, P. Lebeau, M. Messagie, L. Vanhaverbeke, C. Macharis, and J. Van Mierlo, "How total is a total cost of ownership?" *World Electr. Vehicle J.*, vol. 8, no. 4, pp. 742–753, Dec. 2016.
- [17] R. R. Desai, R. B. Chen, E. Hittinger, and E. Williams, "Heterogeneity in economic and carbon benefits of electric technology vehicles in the US," *Environ. Sci. Technol.*, vol. 54, no. 2, pp. 1136–1146, Jan. 2020.
- [18] J. Neubauer, A. Brooker, and E. Wood, "Sensitivity of battery electric vehicle economics to drive patterns, vehicle range, and charge strategies," *J. Power Sources*, vol. 209, pp. 269–277, Jul. 2012.
- [19] B. Cox, C. Bauer, A. Mendoza Beltran, D. P. van Vuuren, and C. L. Mutel, "Life cycle environmental and cost comparison of current and future passenger cars under different energy scenarios," *Appl. Energy*, vol. 269, Jul. 2020, Art. no. 115021.
- [20] G. Fontaras, N.-G. Zacharof, and B. Ciuffo, "Fuel consumption and CO₂ emissions from passenger cars in Europe—Laboratory versus real-world emissions," *Prog. Energy Combustion Sci.*, vol. 60, pp. 97–131, May 2017.
- [21] E. E. Michaelides, "Thermodynamics and energy usage of electric vehicles," *Energy Convers. Manage.*, vol. 203, Jan. 2020, Art. no. 112246.
- [22] C. Mayet, L. Horrein, A. Bouscayrol, P. Delarue, J.-N. Verhille, E. Chattet, and B. Lemaire-Semal, "Comparison of different models and simulation approaches for the energetic study of a subway," *IEEE Trans. Veh. Technol.*, vol. 63, no. 2, pp. 556–565, Feb. 2014.
- [23] N. Noura, I. Erradi, A. Desreveaux, and A. Bouscayrol, "Comparison of the energy consumption of a diesel car and an electric car," in *Proc. IEEE Vehicle Power Propuls. Conf. (VPPC)*, Aug. 2018, pp. 1–6.
- [24] Renault Clio. Accessed: Jun. 24, 2020. [Online]. Available: <https://www.renault.fr/vehicules-particuliers/cliio.html>
- [25] R. Trigui, "Consumption map of a diesel motor k9k 1.5 DCI," IFSTTAR, Paris, France, Internal Rep., 2018.
- [26] A. Bouscayrol, J. P. Hautier, and B. Lemaire-Semal, "Graphic formalisms for the control of multi-physical energetic systems," in *Systemic Design Methodologies for Electrical Energy, Tome (Analysis, Synthesis and Management)*, vol. 1. Hoboken, NJ, USA: Wiley, Oct. 2012, ch. 3.
- [27] Renault Zoe. Accessed: Jun. 24, 2020. [Online]. Available: <http://www.renault.fr/vehicules/vehicules-electriques/zoe>
- [28] M. Scorrano, R. Danielis, and M. Giansoldati, "Dissecting the total cost of ownership of fully electric cars in Italy: The impact of annual distance travelled, home charging and urban driving," *Res. Transp. Econ.*, vol. 80, May 2020, Art. no. 100799.
- [29] E. Hossain, D. Murtaugh, J. Mody, H. Mansur Resalat Faruque, M. S. H. Sunny, and N. Mohammad, "A comprehensive review on second-life batteries: Current state, manufacturing considerations, applications, impacts, barriers & potential solutions, business strategies, and policies," *IEEE Access*, vol. 7, pp. 73215–73252, 2019.
- [30] R. Raustad, "Electric vehicle life cycle cost analysis," Electr. Vehicle Transp. Center, Florida, FL, USA, Final Res. Project Rep. FSEC-CR-2053-17, 2017.
- [31] A. Bouscayrol, E. Castex, P. Delarue, A. Desreveaux, O. Ferla, J. Frotey, R. German, J. Klein, W. Lhomme, and J. F. Sergeant, "Campus of university with mobility based on innovation and carbon neutral," in *Proc. IEEE Vehicle Power Propuls. Conf. (VPPC)*, Dec. 2017, pp. 1–5.
- [32] E. Apostolaki-Iosifidou, P. Codani, and W. Kempton, "Measurement of power loss during electric vehicle charging and discharging," *Energy*, vol. 127, pp. 730–742, May 2017.
- [33] *Global EV Outlook 2020, Entering the decades?*, International Energy Agency Report, Paris, France, 2020.
- [34] *EV Bonus in France*. Accessed: Jun. 24, 2020. [Online]. Available: <https://www.service-public.fr/particuliers/vosdroits/F34014>
- [35] M. A. Aasness and J. Odeck, "The increase of electric vehicle usage in Norway—Incentives and adverse effects," *Eur. Transp. Res. Rev.*, vol. 7, p. 34, Oct. 2015.
- [36] A. Andreï, M. Baudry, S. Beck, A. Foussard, R. Laghouati, J. Lauverjat, P. Lévy, E. Martial, E. Misak, C. Phan, C. Plouhinec, O. Ribon, and N. Riedinger, "Bilan Énergétique de la France pour l'année 2018," Commissariat Général au Développement Durable, Paris, France, Tech. Rep. ISSN : 2557-8510, Jan. 2020.
- [37] S. Tazka and S. Domergue, "Analyse coûts bénéfiques des véhicules électriques," Commissariat Général au Développement Durable, Paris, France, Tech. Rep. ISSN: 2552-227, Jul. 2017.
- [38] B. D. France. *Loans to the Households, France*. Accessed: Jun. 24, 2020. [Online]. Available: <https://www.banque-france.fr/en/taxonomy/term/1011>
- [39] J. Armoogum, E. Bouffard-Savary, Y. Caenen, C. Couderc, J. Courel, F. Delisle, P. Duprat, L. Fouin, D. François, and M.-O. Gascon, "La Mobilité des Français, Panorama Issu de l'Enquête Nationale Transports et Déplacements 2008," Commissariat Général au Développement Durable, Paris, France, Tech. Rep. ISSN: 2111-4498, ISBN: 978-2-11-099412-7, 2010.



ANATOLE DESREVEAUX received the M.S. degree in electric engineering and the Ph.D. degree in electrical engineering from the University of Lille, France, in 2016. He holds a postdoctoral position with the PANDA H2020 Project on simulation of electrified vehicles. His research interests include simulation of electrified vehicles, energy consumption of different kind of vehicle, and development of sustainable campuses based on electro-mobility.



ERIC HITTINGER received the M.Sc. degree in macromolecular sciences from Case Western University, USA, in 2003, and the Ph.D. degree in engineering and public policy from Carnegie Mellon University, USA, in 2012. From 2012 to 2014, he was an Energy Systems Analyst with Aquion and Energy, Pittsburgh, PA, USA. Since 2014, he has been an Assistant Professor in public policy with the Golisano Institute of Technology, Rochester Institute of Technology, USA. Since

2019, he has been a Visiting Professor with the University of Lille, to develop techno-economics model of sustainable campus based on electro-mobility. His research interest includes economics of electrical systems.



ALAIN BOUSCAYROL (Member, IEEE) received the Ph.D. degree in electrical engineering from the Institut National Polytechnique de Toulouse, France, in 1995.

From 1996 to 2005, he was an Associate Professor with the University of Lille, France, where he has been a Professor since 2005. He has initiated the Energetic Macroscopic Representation (EMR) of description and control of energetic systems in 2000. Since 2015, he has been a Coordinator with the Interdisciplinary Program, CUMIN, University of Lille, to propose a sustainable campus based on electro mobility. Since 2018, he has been a Coordinator with the H2020 PANDA Project on innovative simulations of electrified vehicles. His research interests include graphical descriptions for control of electric drives, wind energy conversion systems, railway traction systems, hybrid electric vehicles, and hardware-in-the-loop simulation.



GABRIEL MIHAI SIRBU received the Ph.D. degree in electrical engineering from the University Politehnica of Bucharest. He held positions with the CEIT-IK4 Center San Sebastian, Spain. He joined Renault Technologie Romanie, in 2008, as a Team Leader of developing electrical and thermal simulation for electrical systems. He also held different management positions of simulations and customer requirements teams. He is responsible for synthesis simulations as aerodynamics, thermal, and vehicle dynamics simulations. He also involves with the H2020 PANDA Project on innovative simulation of electrified vehicles.

• • •



ELODIE CASTEX is currently an Associate Professor with the Geography and Urban Planning Department, University of Lille, France. She is coordinating the human and social sciences activities as a CUMIN Interdisciplinary Programmer with the University of Lille, which aims to propose a sustainable campus based on electro-mobility. Her research interests include transportation planning and mobility analysis, especially on subject of news services in mobility and electro-mobility

systems, such as electric vehicles, car sharing, carpooling, and demand responsive transportation.