



**HAL**  
open science

# Sympathetic cooling of $9\text{ Be}^+$ by $88\text{ Sr}^+$ Doppler cooled ions in large Coulomb crystals: an experimental study

A Douillet, B Wirtschafter, J.-P Likforman, Samuel Guibal, V Tugayé, N Sillitoe, J Heinrich, T Louvradoux, J.-P Karr, L Hilico, et al.

## ► To cite this version:

A Douillet, B Wirtschafter, J.-P Likforman, Samuel Guibal, V Tugayé, et al.. Sympathetic cooling of  $9\text{ Be}^+$  by  $88\text{ Sr}^+$  Doppler cooled ions in large Coulomb crystals: an experimental study. North American Conference on Trapped Ions (NACTI), Aug 2017, Boulder (Co), United States. hal-03205364

**HAL Id: hal-03205364**

**<https://hal.science/hal-03205364>**

Submitted on 22 Apr 2021

**HAL** is a multi-disciplinary open access archive for the deposit and dissemination of scientific research documents, whether they are published or not. The documents may come from teaching and research institutions in France or abroad, or from public or private research centers.

L'archive ouverte pluridisciplinaire **HAL**, est destinée au dépôt et à la diffusion de documents scientifiques de niveau recherche, publiés ou non, émanant des établissements d'enseignement et de recherche français ou étrangers, des laboratoires publics ou privés.



# Sympathetic cooling of ${}^9\text{Be}^+$ by ${}^{88}\text{Sr}^+$ Doppler cooled ions in large Coulomb crystals: an experimental study

A. Douillet<sup>2</sup>, B. Wirtschatter<sup>1</sup>, J.-P. Likforman<sup>1</sup>, S. Guibal<sup>1</sup>, V. Tugayé<sup>1</sup>, N. Sillitoe<sup>2</sup>,  
J. Heinrich<sup>2</sup>, T. Louvradoux<sup>2</sup>, J.-P. Karr<sup>2</sup>, L. Hilico<sup>2</sup>, and L. Guidoni<sup>1</sup>

<sup>1</sup>Laboratoire Matériaux et Phénomènes Quantiques, Université Paris-Diderot, Sorbonne Paris Cité, CNRS, F-75013 Paris, France

<sup>2</sup>Laboratoire LKB, UPMC-Université Paris 6, ENS, CNRS, Collège de France F-75005 Paris  
and Université d'Evry-Val d'Essonne, F-91000 Evry, France

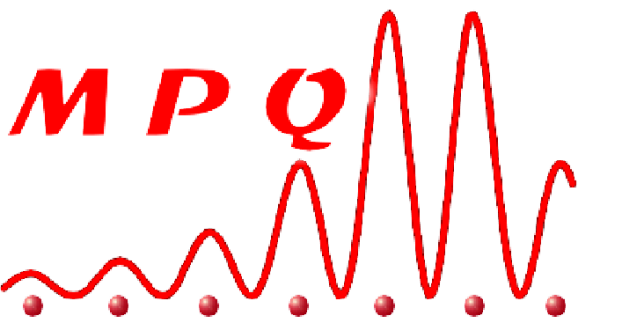

## Motivation

sympathetic cooling of light species by heavy coolants

- precision molecular spectroscopy  
J. C. J. Koelemeij et al., Phys. Rev. Lett. **98**, 173002 (2007).  
J. Biesheuvel et al., Nature Comm., **7**, 10385 (2016)

- multicharged ions  
L. Schmoeger et al., Science, **347**, 1233 (2015)

- GBAR experiment  
P. Perez and Y. Sacquin, Classical and Quantum Gravity, **29**, 18 (2012)

- experiments test for molecular dynamics simulations  
N. Sillitoe et al., arXiv:1705.03347 [physics.comp-ph]

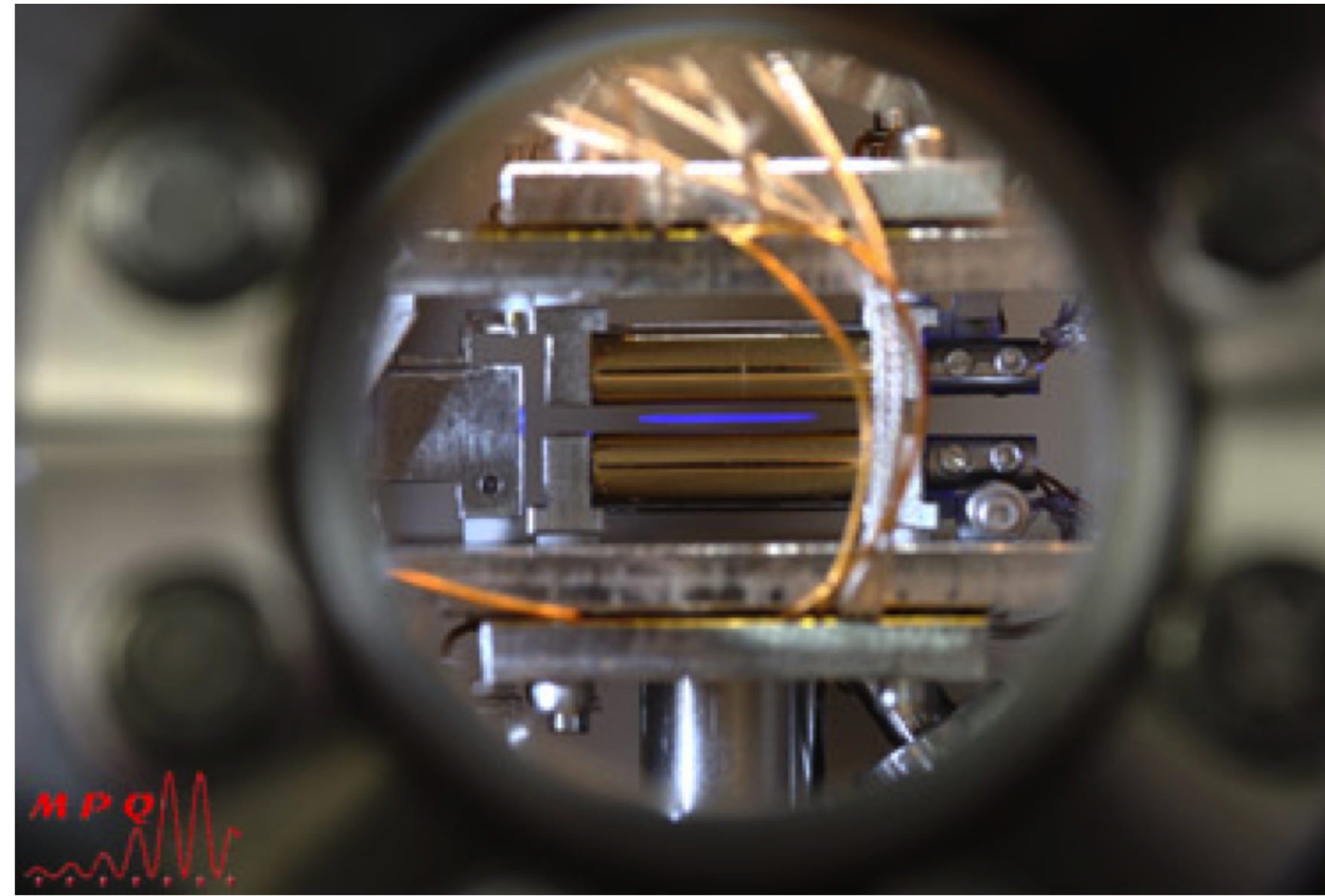

## Trap features

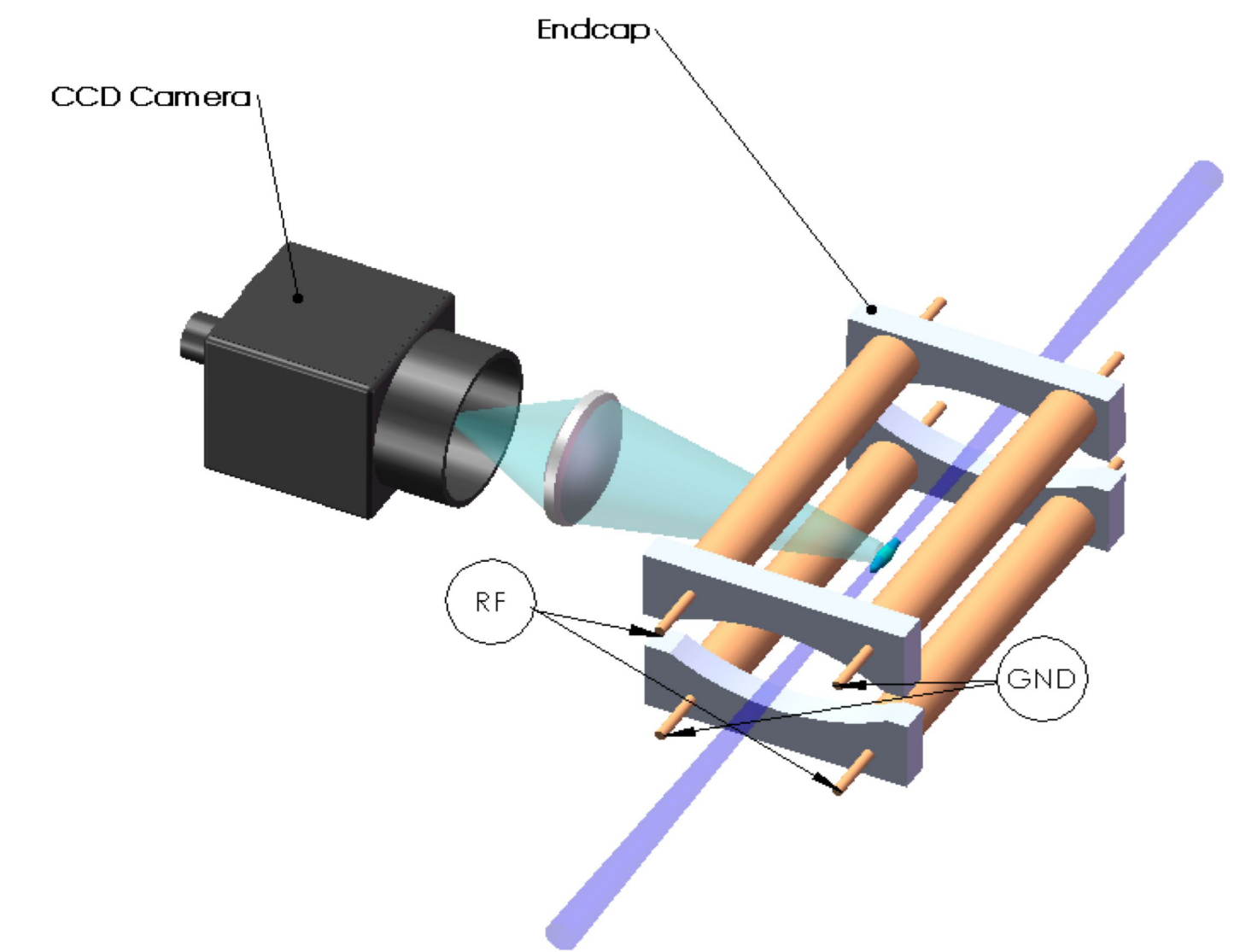

- inner radius  $R = 3.4$  mm
- length  $Z_1 = 30$  mm
- radio-frequency 7.6 MHz
- amplitudes  $V_{RF}$  50 - 800 V

- axial motional frequency ( ${}^{88}\text{Sr}^+$ ): 10 - 30 kHz
- typical stability parameter ( ${}^{88}\text{Sr}^+$ )  $q < 0.005$

## Sympathetic cooling of $\text{Sr}^+$ isotopes

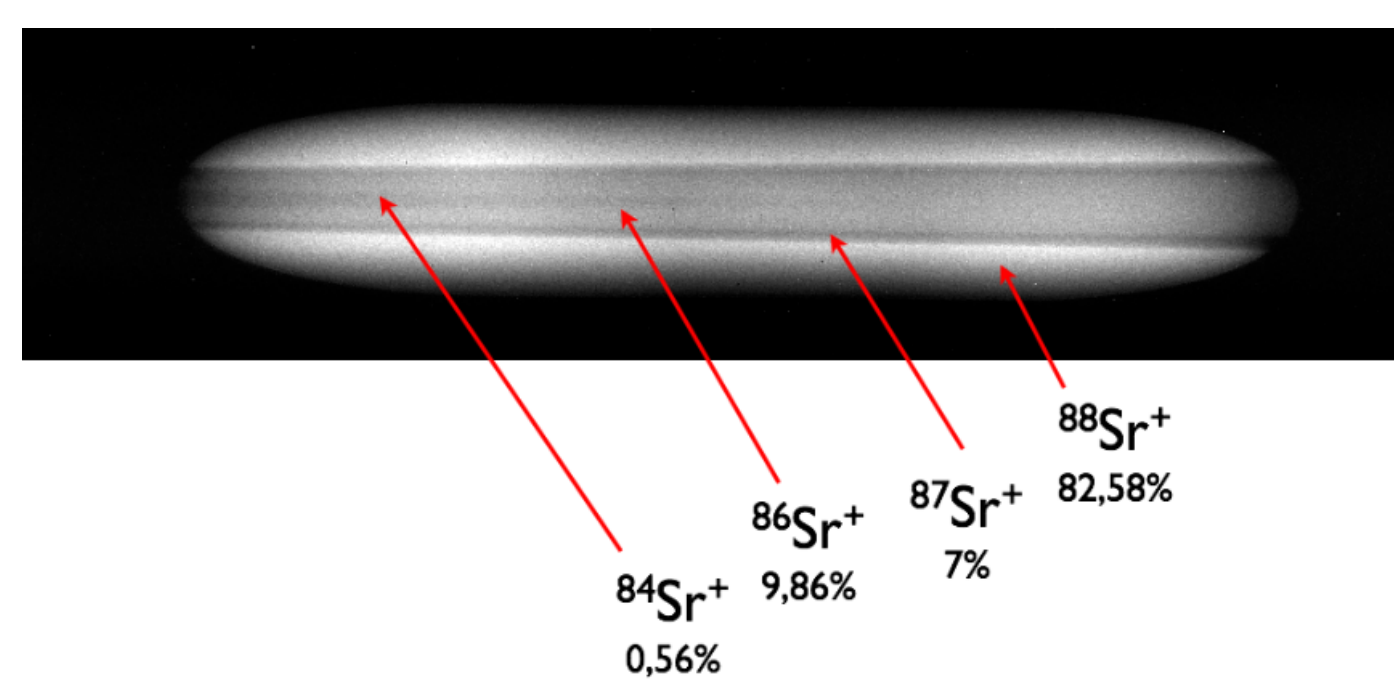

## Experimental setup

### Doppler cooling of $\text{Sr}^+$

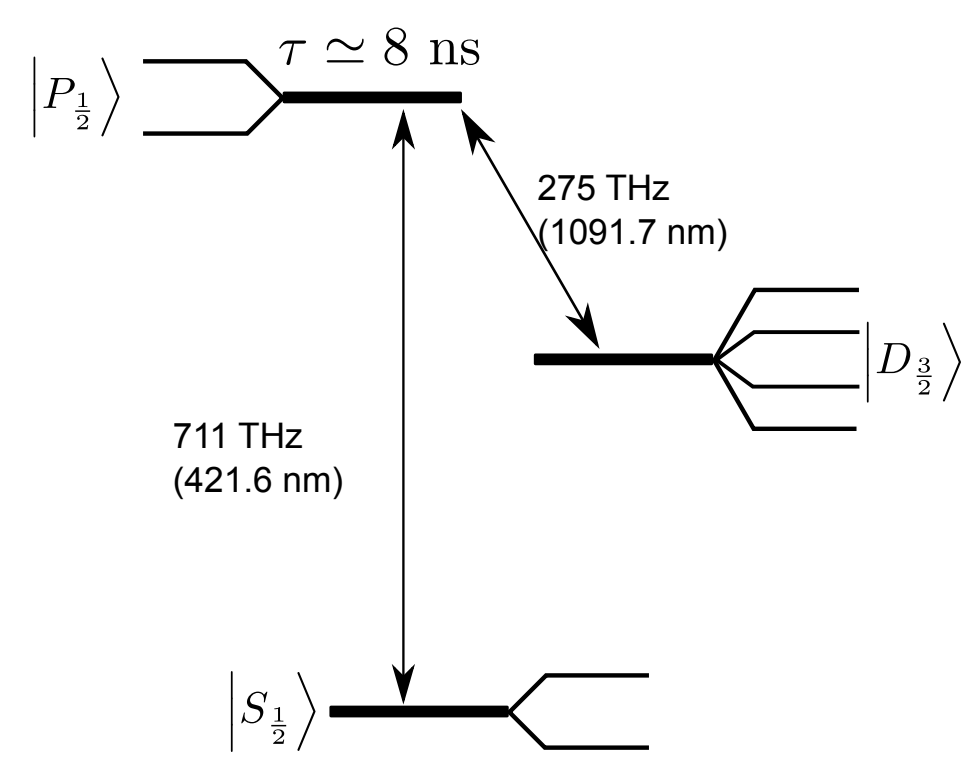

### Photoionization of Sr

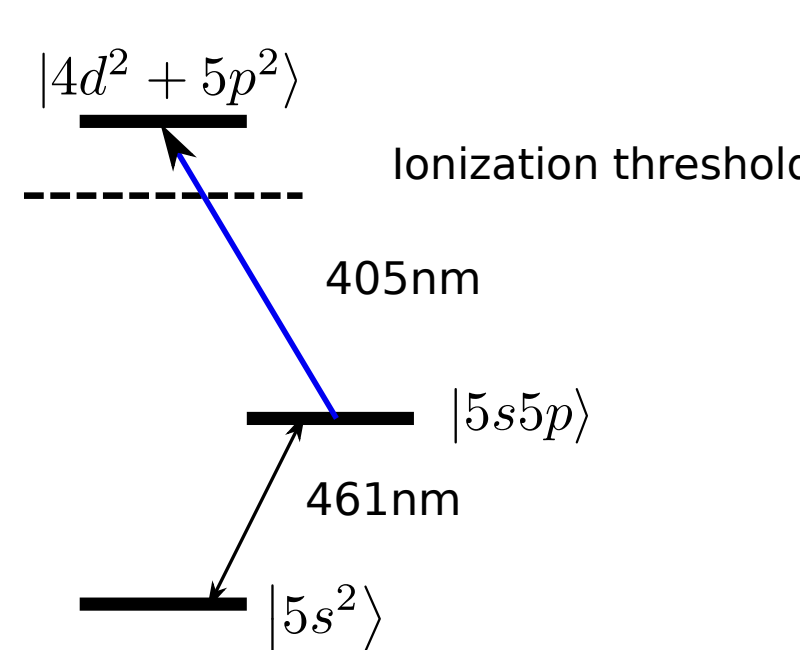

### Photoionization of Be

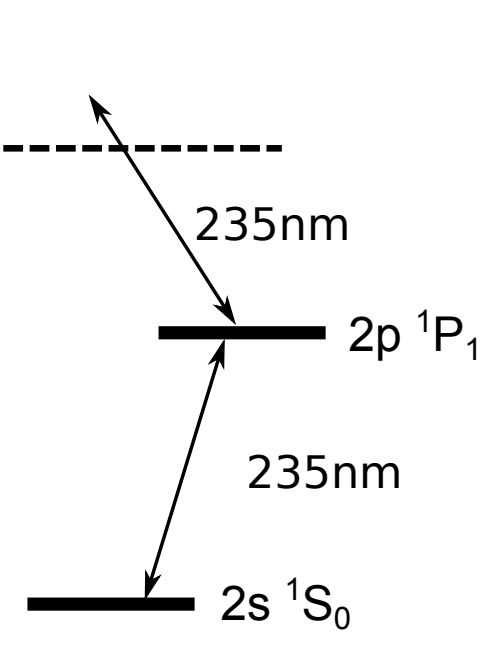

### $\text{Sr}^+$ cooling lasers and stabilization

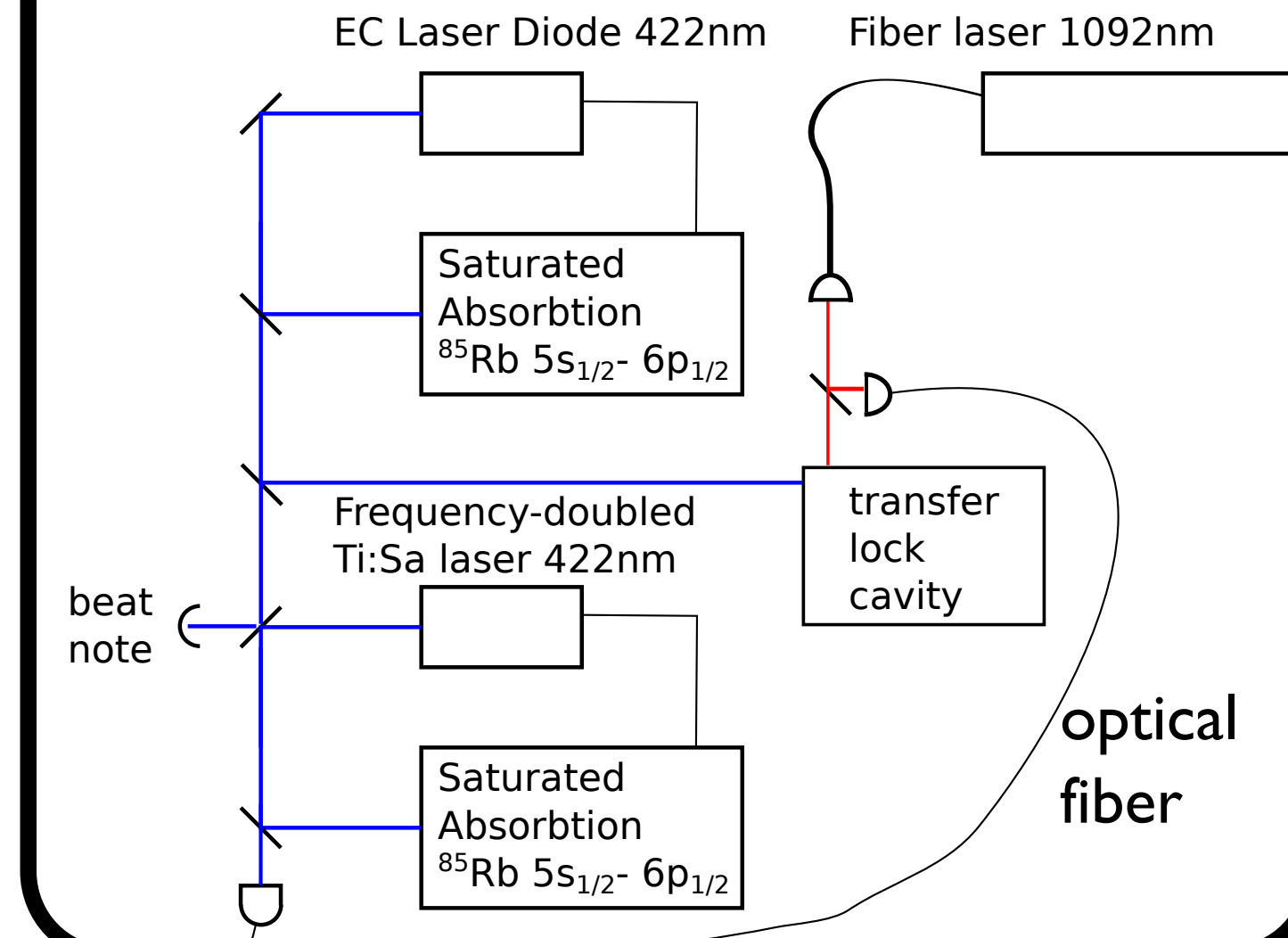

### ${}^9\text{Be}$ photo-ionization

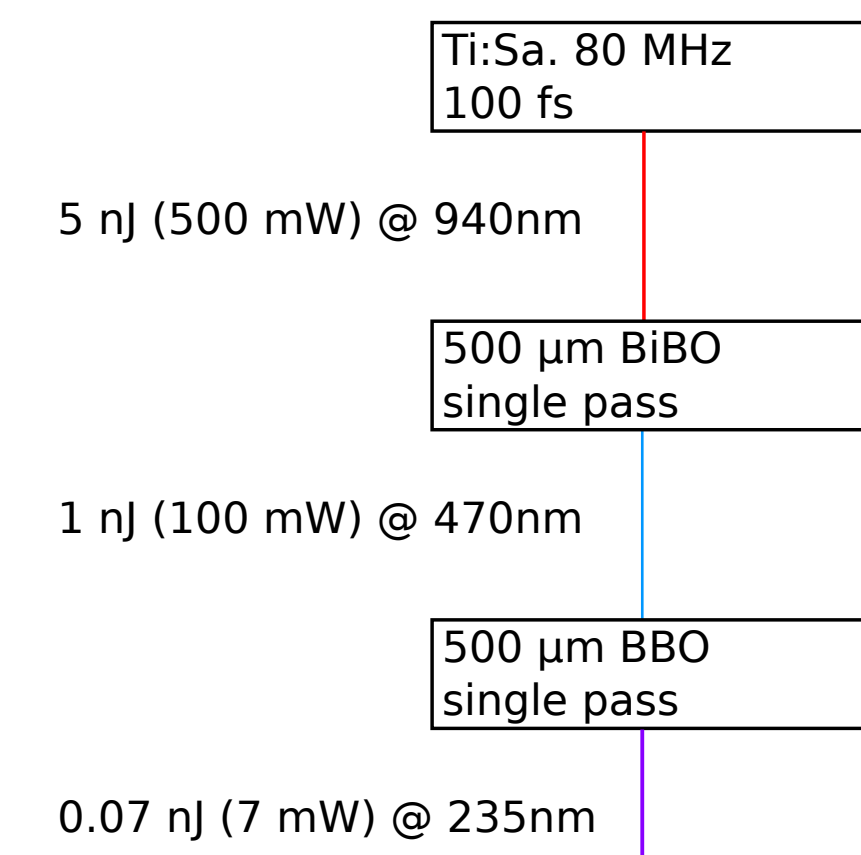

### ${}^{88}\text{Sr}$ photo-ionization

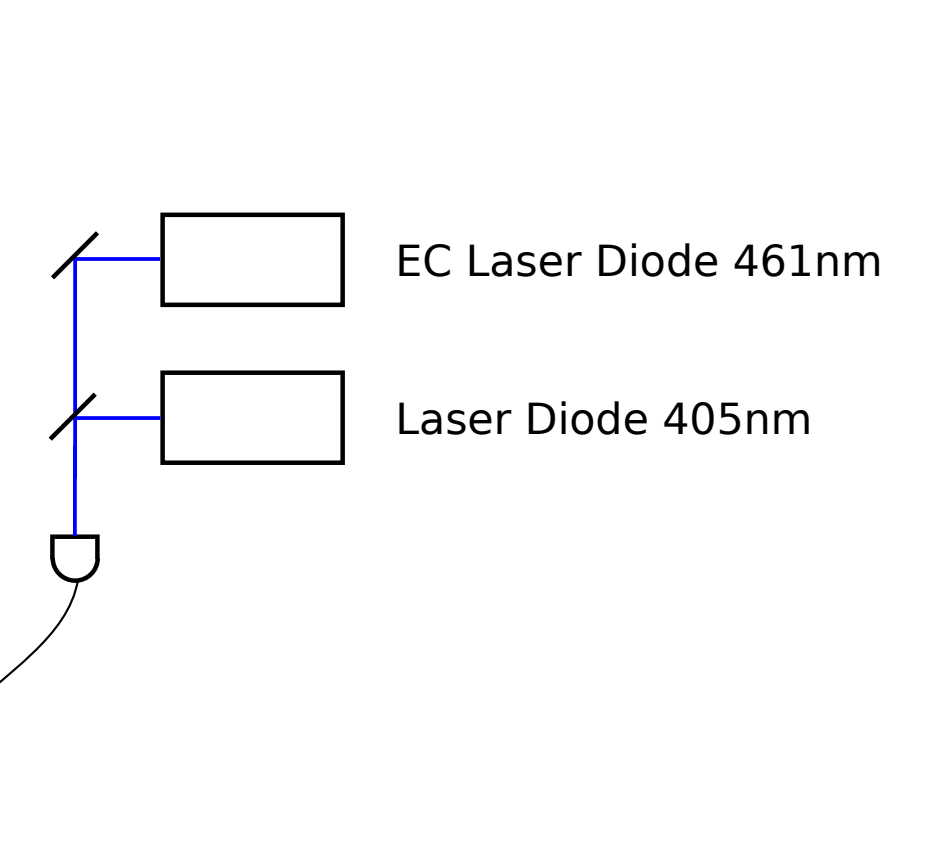

### Vacuum chamber

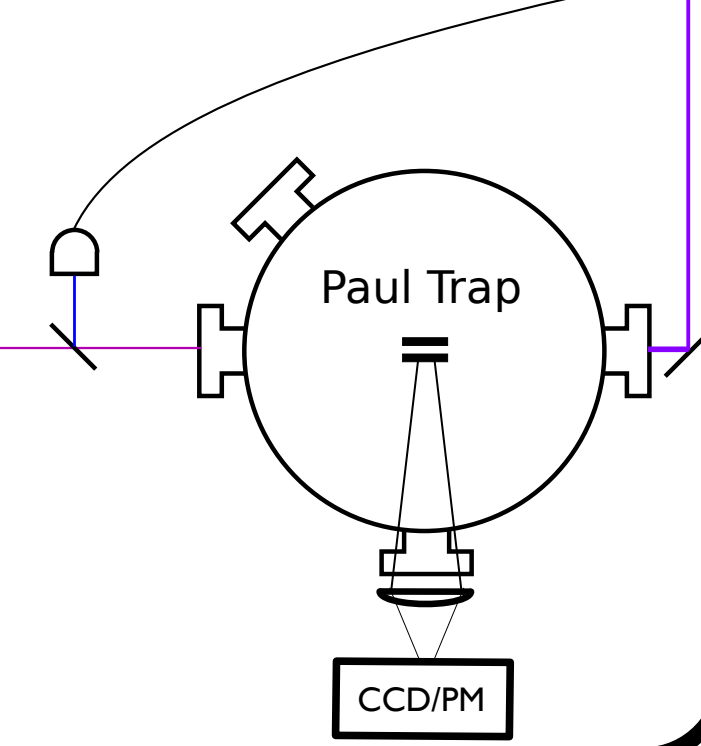

### $\text{Be}^+$ probing laser

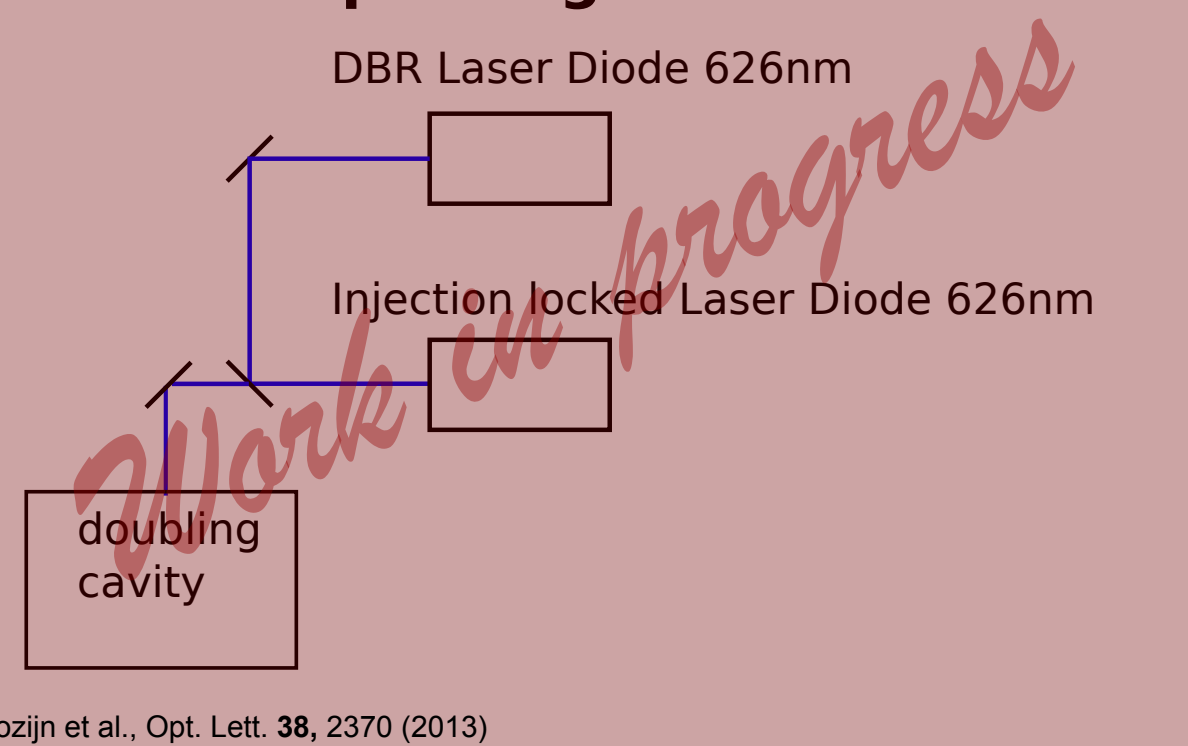

## Preliminary results

### numerical simulations of steady-state

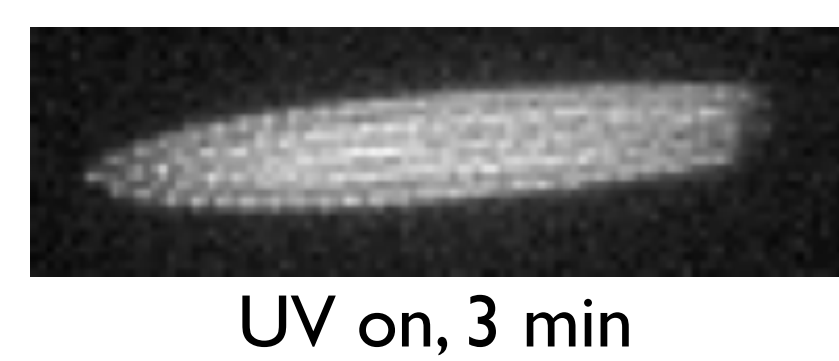
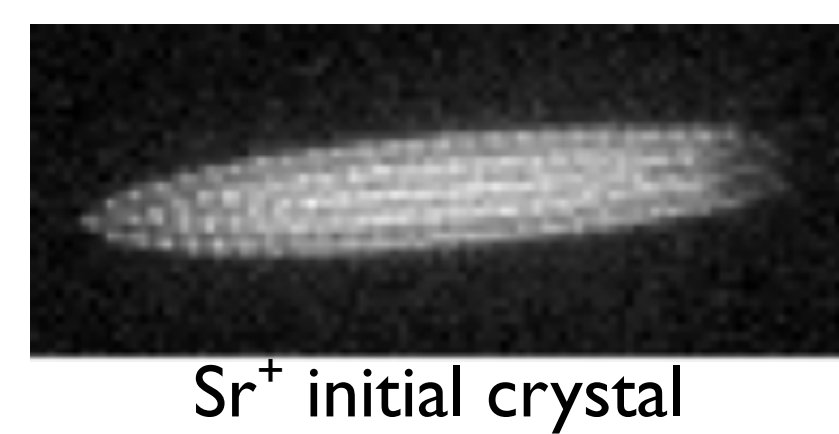
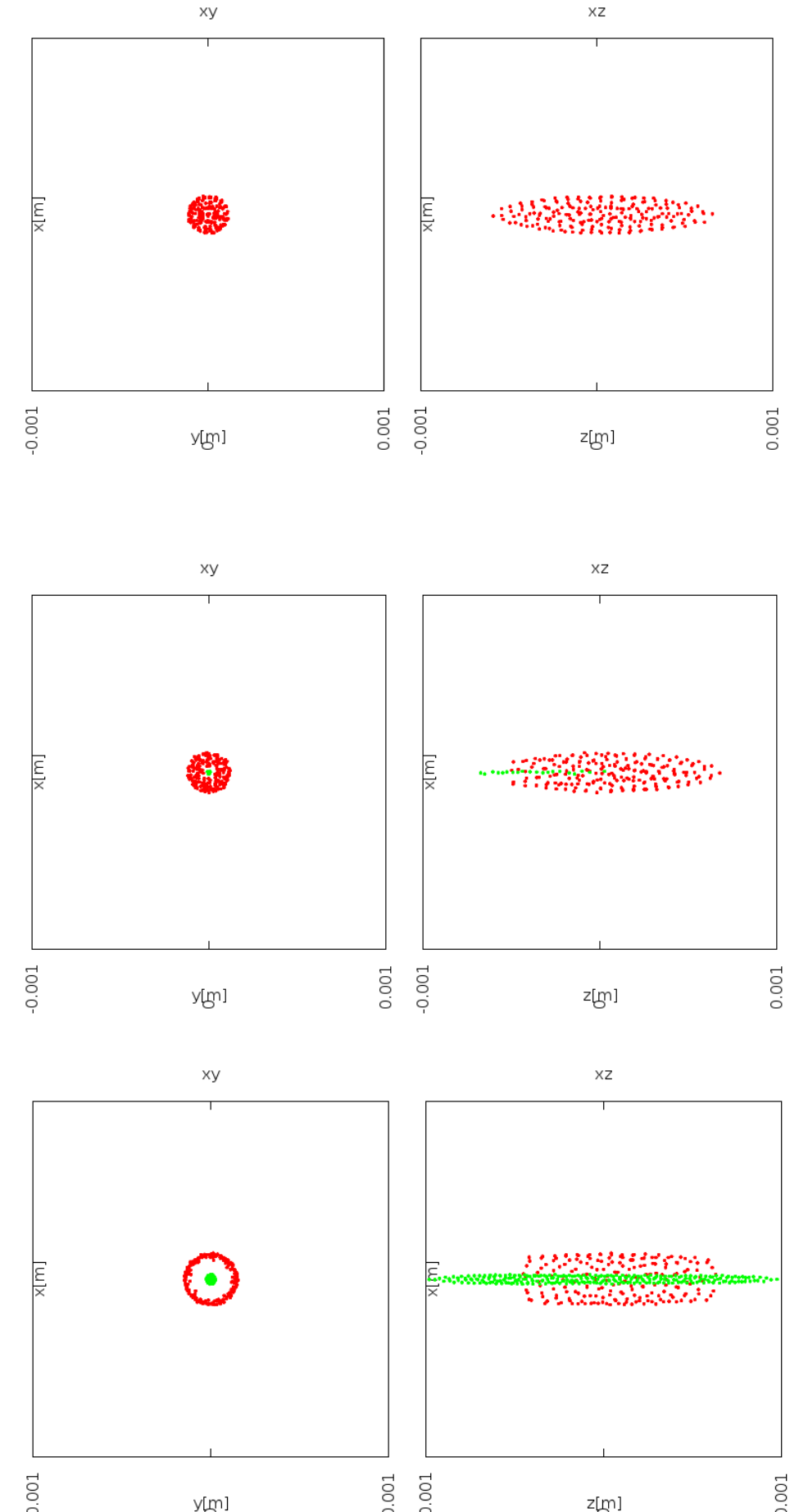

- qualitatively long ( $> 10$  s) cooling dynamics
- independent of loading order
- tickle confirmation of mass ratio

## Next steps

### ${}^{88}\text{Sr}^+$ isotope selection

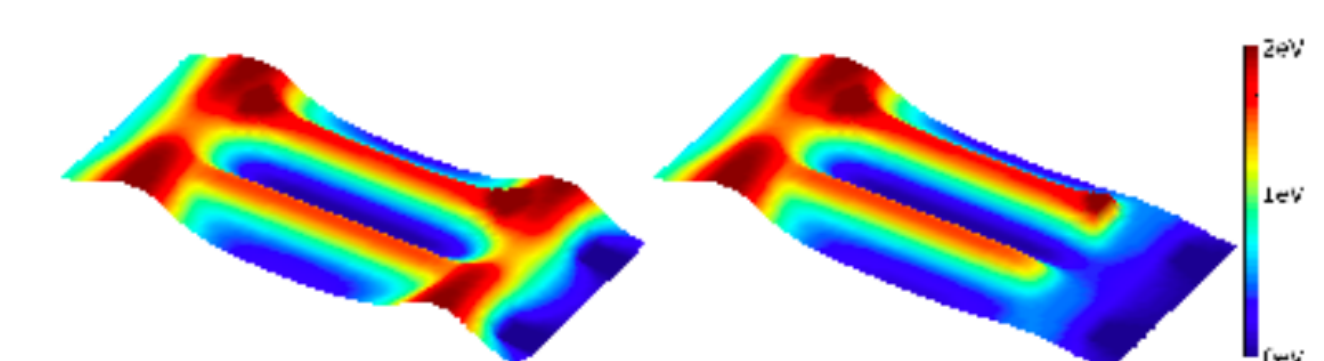

### probing ${}^9\text{Be}^+$ for diagnostics

### study of sympathetic cooling dynamics